

## DAC101S101 and DAC101S101Q-1 10-Bit Micro Power, RRO Digital-to-Analog Converter

### 1 Features

- DAC101S101Q is AEC-Q100 Grade 1 Qualified and is Manufactured on an Automotive Grade Flow.
- Ensured Monotonicity
- Low Power Operation
- Rail-to-Rail Voltage Output
- Power-on Reset to Zero Volts Output
- Wide Temperature Range of  $-40^{\circ}\text{C}$  to  $+125^{\circ}\text{C}$
- Wide Power Supply Range of 2.7 V to 5.5 V
- Small Packages
- Power Down Feature
- Resolution 10 bits
- DNL  $+0.15$ ,  $-0.05$  LSB (typical)
- Output Settling Time 8  $\mu\text{s}$  (typical)
- Zero Code Error 3.3 mV (typical)
- Full-Scale Error  $-0.06$  %FS (typical)
- Power Consumption
  - Normal Mode, 0.63 mW (3.6 V) / 1.41 mW (5.5 V) typical
  - Power Down Mode, 0.14  $\mu\text{W}$  (3.6 V) / 0.33  $\mu\text{W}$  (5.5 V) typical

### 2 Applications

- Battery-Powered Instruments
- Digital Gain and Offset Adjustment
- Programmable Voltage & Current Sources
- Programmable Attenuators
- Automotive

### 3 Description

The DAC101S101 is a full-featured, general purpose 10-bit voltage-output digital-to-analog converter (DAC) that can operate from a single  $+2.7$  V to 5.5 V supply and consumes just 175  $\mu\text{A}$  of current at 3.6 Volts. The on-chip output amplifier allows rail-to-rail output swing and the three wire serial interface operates at clock rates up to 30 MHz over the specified supply voltage range and is compatible with standard SPI, QSPI, MICROWIRE and DSP interfaces. Competitive devices are limited to 20 MHz clock rates at supply voltages in the 2.7 V to 3.6 V range.

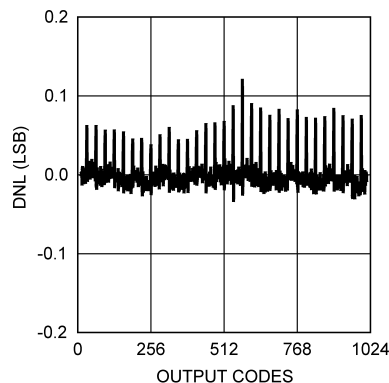
The supply voltage for the DAC101S101 serves as its voltage reference, providing the widest possible output dynamic range. A power-on reset circuit ensures that the DAC output powers up to zero volts and remains there until there is a valid write to the device. A power-down feature reduces power consumption to less than a microWatt.

#### Device Information<sup>(1)</sup>

| PART NUMBER               | PACKAGE    | BODY SIZE (NOM)   |
|---------------------------|------------|-------------------|
| DAC101S101                | VSSOP (8)  | 3.00 mm x 3.00 mm |
| DAC101S101, DAC101S101-Q1 | SOT-23 (6) | 1.60 mm x 2.90 mm |

(1) For all available packages, see the orderable addendum at the end of the data sheet.

**DNL at  $V_A = 3$  V**



## Table of Contents

|  |           |  |           |
|--|-----------|--|-----------|
| <b>1 Features</b> .....                        | <b>1</b>  | 8.4 Device Functional Modes .....                                | <b>18</b> |
| <b>2 Applications</b> .....                    | <b>1</b>  | 8.5 Programming .....  | <b>19</b> |
| <b>3 Description</b> .....                     | <b>1</b>  | <b>9 Application and Implementation</b> .....                    | <b>21</b> |
| <b>4 Revision History</b> .....                | <b>2</b>  | 9.1 Application Information .....                                | <b>21</b> |
| <b>5 Description (continued)</b> .....         | <b>3</b>  | 9.2 Typical Application .....                                    | <b>21</b> |
| <b>6 Pin Configuration and Functions</b> ..... | <b>3</b>  | <b>10 Power Supply Recommendations</b> .....                     | <b>23</b> |
| <b>7 Specifications</b> .....                  | <b>4</b>  | 10.1 Using References as Power Supplies .....                    | <b>23</b> |
| 7.1 Absolute Maximum Ratings .....             | <b>4</b>  | <b>11 Layout</b> .....   | <b>26</b> |
| 7.2 ESD Ratings DAC101S101 .....               | <b>4</b>  | 11.1 Layout Guidelines .....                                     | <b>26</b> |
| 7.3 ESD Ratings DAC101S101-Q1 .....            | <b>4</b>  | 11.2 Layout Example .....  | <b>26</b> |
| 7.4 Recommended Operating Conditions .....     | <b>5</b>  | <b>12 Device and Documentation Support</b> .....                 | <b>27</b> |
| 7.5 Thermal Information .....                  | <b>5</b>  | 12.1 Device Support .....  | <b>27</b> |
| 7.6 Electrical Characteristics .....           | <b>6</b>  | 12.2 Related Links .....   | <b>28</b> |
| 7.7 A.C. and Timing Requirements .....         | <b>9</b>  | 12.3 Community Resources .....                                   | <b>28</b> |
| 7.8 Typical Characteristics .....              | <b>11</b> | 12.4 Trademarks .....  | <b>28</b> |
| <b>8 Detailed Description</b> .....            | <b>17</b> | 12.5 Electrostatic Discharge Caution .....                       | <b>28</b> |
| 8.1 Overview .....                             | <b>17</b> | 12.6 Glossary .....  | <b>28</b> |
| 8.2 Functional Block Diagram .....             | <b>17</b> | <b>13 Mechanical, Packaging, and Orderable Information</b> ..... | <b>28</b> |
| 8.3 Feature Description .....                  | <b>17</b> |  |           |

## 4 Revision History

NOTE: Page numbers for previous revisions may differ from page numbers in the current version.

| <b>Changes from Revision F (March 2013) to Revision G</b>   | <b>Page</b> |
|---|-------------|
| • Added <i>Device Information</i> table, <i>ESD Ratings</i> table, <i>Feature Description</i> section, <i>Device Functional Modes</i> , <i>Application and Implementation</i> section, <i>Power Supply Recommendations</i> section, <i>Layout</i> section, <i>Device and Documentation Support</i> section, and <i>Mechanical, Packaging, and Orderable Information</i> section ..... | <b>1</b>    |
| • Updated <i>Operating Conditions</i> table to a <i>Recommended Operating Conditions</i> table .....  | <b>5</b>    |
| • Updated <i>Layout, Grounding, and Bypassing</i> section to a <i>Layout Guidelines</i> section .....   | <b>26</b>   |

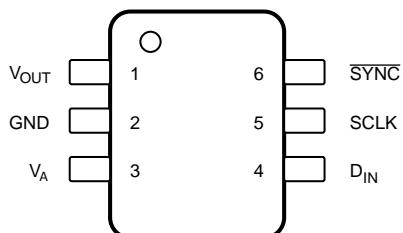
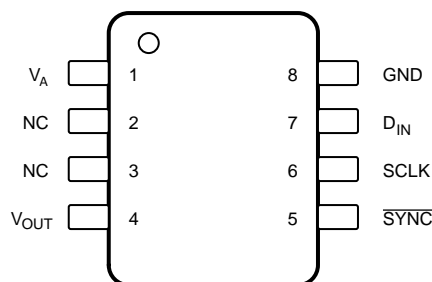
| <b>Changes from Revision E (March 2013) to Revision F</b>  | <b>Page</b> |
|--|-------------|
| • Changed layout of National Data Sheet to TI format ..... | <b>26</b>   |

## 5 Description (continued)

The low power consumption and small packages of the DAC101S101 make it an excellent choice for use in battery operated equipment.

The DAC101S101 is a direct replacement for the AD5310 and is one of a family of pin compatible DACs, including the 8-bit DAC081S101 and the 12-bit DAC121S101. The DAC101S101 operates over the extended industrial temperature range of  $-40^{\circ}\text{C}$  to  $+105^{\circ}\text{C}$  while the DAC101S101Q operates over the Grade 1 automotive temperature range of  $-40^{\circ}\text{C}$  to  $+125^{\circ}\text{C}$ . The DAC101S101 is available in a 6-lead SOT and an 8-lead VSSOP and the DAC101S101Q is available in the 6-lead SOT only.

## 6 Pin Configuration and Functions

**DAC101S101 and DAC101S101-Q1 DDC Package**
**6-Pin (SOT-23)  
Top View**

**DAC101S101 DKG Package**
**8-Pin (VSSOP)  
Top View**


### Pin Functions

| NAME                     | PIN                  |                        |                         | I/O <sup>(1)</sup> | DESCRIPTION  |
|--------------------------|----------------------|------------------------|-------------------------|--------------------|--|
|                          | DAC101S101<br>SOT-23 | DAC101S101-Q1<br>VSSOP | DAC101S101-Q1<br>SOT-23 |                    |  |
| D <sub>IN</sub>          | 4                    | 7                      | 4                       | I                  | Serial Data Input. Data is clocked into the 16-bit shift register on the falling edges of SCLK after the fall of SYNC.   |
| GND                      | 2                    | 8                      | 2                       | G                  | Ground reference for all on-chip circuitry.  |
| NC                       | –                    | 2,3                    | –                       | –                  | No Connect. There is no internal connection to these pins.   |
| SCLK                     | 5                    | 6                      | 5                       | I                  | Serial Clock Input. Data is clocked into the input shift register on the falling edges of this pin.  |
| $\overline{\text{SYNC}}$ | 6                    | 5                      | 6                       | I                  | Frame synchronization input for the data input. When this pin goes low, it enables the input shift register and data is transferred on the falling edges of SCLK. The DAC is updated on the 16th clock cycle unless SYNC is brought high before the 16th clock, in which case the rising edge of SYNC acts as an interrupt and the write sequence is ignored by the DAC. |
| V <sub>A</sub>           | 3                    | 1                      | 3                       | S                  | Power supply and Reference input. Should be decoupled to GND.  |
| V <sub>OUT</sub>         | 1                    | 4                      | 1                       | O                  | DAC Analog Output Voltage.   |

(1) G = Ground, I = Input, O = Output, S = Supply

## 7 Specifications

### 7.1 Absolute Maximum Ratings

 over operating free-air temperature range (unless otherwise noted) <sup>(1)(2)(3)</sup>

|   | MIN  | MAX                | UNIT             |
|---|------|--------------------|------------------|
| Supply voltage, $V_A$                         |      | 6.5                | V                |
| Voltage on any input pin                      | -0.3 | $(V_A + 0.3)$      | V                |
| Input current at any pin <sup>(4)</sup>       |      | 10                 | mA               |
| Package input current <sup>(4)</sup>          |      | 20                 | mA               |
| Power consumption at $T_A = 25^\circ\text{C}$ |      | See <sup>(5)</sup> |                  |
| Storage temperature, $T_{\text{stg}}$         | -65  | 150                | $^\circ\text{C}$ |

- (1) Absolute Maximum Ratings indicate limits beyond which damage to the device may occur. Operating Ratings indicate conditions for which the device is functional, but do not ensure specific performance limits. For ensured specifications and test conditions, see the Electrical Characteristics. The ensured specifications apply only for the test conditions listed. Some performance characteristics may degrade when the device is not operated under the listed test conditions.
- (2) If Military/Aerospace specified devices are required, please contact the Texas Instruments Sales Office/ Distributors for availability and specifications.
- (3) All voltages are measured with respect to GND = 0V, unless otherwise specified
- (4) When the input voltage at any pin exceeds the power supplies (that is, less than GND, or greater than  $V_A$ ), the current at that pin should be limited to 10 mA. The 20 mA maximum package input current rating limits the number of pins that can safely exceed the power supplies with an input current of 10 mA to two.
- (5) The absolute maximum junction temperature ( $T_{\text{Jmax}}$ ) for this device is  $150^\circ\text{C}$ . The maximum allowable power dissipation is dictated by  $T_{\text{Jmax}}$ , the junction-to-ambient thermal resistance ( $\theta_{\text{JA}}$ ), and the ambient temperature ( $T_A$ ), and can be calculated using the formula  $P_{\text{DMAX}} = (T_{\text{Jmax}} - T_A) / \theta_{\text{JA}}$ . The values for maximum power dissipation will be reached only when the device is operated in a severe fault condition (e.g., when input or output pins are driven beyond the power supply voltages, or the power supply polarity is reversed). Obviously, such conditions should always be avoided.

### 7.2 ESD Ratings DAC101S101

|  |  | VALUE      | UNIT |
|--|--|------------|------|
| $V_{\text{(ESD)}}$ Electrostatic discharge | Human-body model (HBM), per ANSI/ESDA/JEDEC JS-001 <sup>(1)(2)</sup> | $\pm 2500$ | V    |
|  | Machine Model  | $\pm 250$  |      |

- (1) JEDEC document JEP155 states that 500-V HBM allows safe manufacturing with a standard ESD control process.
- (2) Human body model is 100 pF capacitor discharged through a 1.5 k $\Omega$  resistor. Machine model is 220 pF discharged through ZERO Ohms.

### 7.3 ESD Ratings DAC101S101-Q1

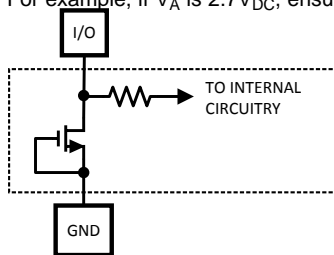
|  |   | VALUE      | UNIT |
|--|---|------------|------|
| $V_{\text{(ESD)}}$ Electrostatic discharge | Human-body model (HBM), per AEC Q100-002 <sup>(1)</sup> | $\pm 2500$ | V    |
|  | Machine Model   | $\pm 250$  |      |

- (1) AEC Q100-002 indicates that HBM stressing shall be in accordance with the ANSI/ESDA/JEDEC JS-001 specification.

## 7.4 Recommended Operating Conditions<sup>(1) (2)</sup>

|   |               | MIN                             | MAX                    | UNIT |
|---|---------------|---------------------------------|------------------------|------|
| Operating temperature                         | DAC101S101    | -40°C ≤ T <sub>A</sub> ≤ +105°C |                        |      |
|   | DAC101S101-Q1 | -40°C ≤ T <sub>A</sub> ≤ +125°C |                        |      |
| Supply voltage, V <sub>A</sub> <sup>(3)</sup> |               | 2.7                             | 5.5                    | V    |
| Any input voltage <sup>(4)</sup>              |               | -0.1                            | (V <sub>A</sub> + 0.1) | V    |
| Output load                                   |               | 0                               | 1500                   | pF   |
| SCLK frequency                                |               | Up to 30 MHz                    |                        |      |

- (1) Absolute Maximum Ratings indicate limits beyond which damage to the device may occur. Operating Ratings indicate conditions for which the device is functional, but do not ensure specific performance limits. For ensured specifications and test conditions, see the Electrical Characteristics. The ensured specifications apply only for the test conditions listed. Some performance characteristics may degrade when the device is not operated under the listed test conditions.
- (2) All voltages are measured with respect to GND = 0V, unless otherwise specified
- (3) To ensure accuracy, it is required that V<sub>A</sub> be well bypassed.
- (4) The analog inputs are protected as shown below. Input voltage magnitudes up to V<sub>A</sub> + 300 mV or to 300 mV below GND will not damage this device. However, errors in the conversion result can occur if any input goes above V<sub>A</sub> or below GND by more than 100 mV. For example, if V<sub>A</sub> is 2.7V<sub>DC</sub>, ensure that -100mV ≤ input voltages ≤ 2.8V<sub>DC</sub> to ensure accurate conversions.



## 7.5 Thermal Information

| THERMAL METRIC <sup>(1)</sup> |  | DAC101S101,<br>DAC101S101-Q1 | DAC101S101  | UNIT |
|-------------------------------|--|------------------------------|-------------|------|
|                               |  | DDC (SOT-23)                 | DGK (VSSOP) |      |
|                               |  | 6 PINS                       | 8 PINS      |      |
| R <sub>θJA</sub>              | Junction-to-ambient thermal resistance       | 250                          | 240         | °C/W |
| R <sub>θJC(top)</sub>         | Junction-to-case (top) thermal resistance    | 58.8                         | 70.0        | °C/W |
| R <sub>θJB</sub>              | Junction-to-board thermal resistance         | 30.6                         | 100.2       | °C/W |
| Ψ <sub>JT</sub>               | Junction-to-top characterization parameter   | 1.6                          | 11.3        | °C/W |
| Ψ <sub>JB</sub>               | Junction-to-board characterization parameter | 30.1                         | 98.7        | °C/W |
| R <sub>θJC(bot)</sub>         | Junction-to-case (bottom) thermal resistance | N/A                          | N/A         | °C/W |

- (1) For more information about traditional and new thermal metrics, see the *Semiconductor and IC Package Thermal Metrics* application report, [SPRA953](#).

**DAC101S101, DAC101S101-Q1**

SNAS321G – JUNE 2005 – REVISED APRIL 2016

[www.ti.com](http://www.ti.com)
**7.6 Electrical Characteristics**

 The following specifications apply for  $V_A = +2.7\text{ V}$  to  $+5.5\text{ V}$ ,  $R_L = 2\text{ k}\Omega$  to GND,  $C_L = 200\text{ pF}$  to GND,  $f_{\text{SCLK}} = 30\text{ MHz}$ , input code range 12 to 1011,  $T_A = 25^\circ\text{C}$ , unless otherwise specified.

| PARAMETER                     |                              | TEST CONDITIONS  | MIN <sup>(1)</sup> | TYP <sup>(1)</sup> | MAX <sup>(1)</sup> | UNIT                         |
|-------------------------------|------------------------------|--|--------------------|--------------------|--------------------|------------------------------|
| <b>STATIC PERFORMANCE</b>     |                              |  |                    |                    |                    |                              |
|                               | Resolution                   | DAC101S101: $-40^\circ\text{C} \leq T_A \leq +105^\circ\text{C}$ , DAC101S101Q: $-40^\circ\text{C} \leq T_A \leq +125^\circ\text{C}$     | 10                 |                    |                    | Bits                         |
|                               | Monotonicity                 | DAC101S101: $-40^\circ\text{C} \leq T_A \leq +105^\circ\text{C}$ , DAC101S101Q: $-40^\circ\text{C} \leq T_A \leq +125^\circ\text{C}$     | 10                 |                    |                    | Bits                         |
| INL                           | Integral non-linearity       | Over decimal codes 12 to 1011  |                    | $\pm 0.6$          |                    | LSB                          |
|                               |                              | DAC101S101: $-40^\circ\text{C} \leq T_A \leq +105^\circ\text{C}$ , DAC101S101Q: $-40^\circ\text{C} \leq T_A \leq +125^\circ\text{C}$     | -2.8               |                    | 2.8                |                              |
| DNL                           | Differential non-linearity   | $V_A = 2.7\text{ V}$ to $5.5\text{ V}$   |                    | $-0.05/+0.15$      |                    | LSB                          |
|                               |                              | DAC101S101: $-40^\circ\text{C} \leq T_A \leq +105^\circ\text{C}$ , DAC101S101Q: $-40^\circ\text{C} \leq T_A \leq +125^\circ\text{C}$     | -0.2               |                    | 0.35               |                              |
| ZE                            | Zero code error              | $I_{\text{OUT}} = 0$   |                    | 3.3                |                    | mV                           |
|                               |                              | DAC101S101: $-40^\circ\text{C} \leq T_A \leq +105^\circ\text{C}$ , DAC101S101Q: $-40^\circ\text{C} \leq T_A \leq +125^\circ\text{C}$     |                    |                    | 15                 |                              |
| FSE                           | Full-scale error             | $I_{\text{OUT}} = 0$   |                    | -0.06              |                    | %FSR                         |
|                               |                              | DAC101S101: $-40^\circ\text{C} \leq T_A \leq +105^\circ\text{C}$ , DAC101S101Q: $-40^\circ\text{C} \leq T_A \leq +125^\circ\text{C}$     |                    |                    | -1                 |                              |
| GE                            | Gain error                   | All ones Loaded to DAC register  |                    | -0.1               |                    | %FSR                         |
|                               |                              | DAC101S101: $-40^\circ\text{C} \leq T_A \leq +105^\circ\text{C}$ , DAC101S101Q: $-40^\circ\text{C} \leq T_A \leq +125^\circ\text{C}$     | -1                 |                    | 1                  |                              |
| ZCED                          | Zero code error drift        |  |                    | -20                |                    | $\mu\text{V}/^\circ\text{C}$ |
| TC GE                         | Gain error tempco            | $V_A = 3\text{ V}$   |                    | -0.7               |                    | ppm/ $^\circ\text{C}$        |
|                               |                              | $V_A = 5\text{ V}$   |                    | -1                 |                    | ppm/ $^\circ\text{C}$        |
| <b>OUTPUT CHARACTERISTICS</b> |                              |  |                    |                    |                    |                              |
|                               | Output voltage range         | DAC101S101: $-40^\circ\text{C} \leq T_A \leq +105^\circ\text{C}$ , DAC101S101Q: $-40^\circ\text{C} \leq T_A \leq +125^\circ\text{C}$ (2) | 0                  |                    | $V_A$              | V                            |
| ZCO                           | Zero code output             | $V_A = 3\text{ V}$ , $I_{\text{OUT}} = 10\text{ }\mu\text{A}$  |                    | 1.8                |                    | mV                           |
|                               |                              | $V_A = 3\text{ V}$ , $I_{\text{OUT}} = 100\text{ }\mu\text{A}$   |                    | 5                  |                    | mV                           |
|                               |                              | $V_A = 5\text{ V}$ , $I_{\text{OUT}} = 10\text{ }\mu\text{A}$  |                    | 3.7                |                    | mV                           |
|                               |                              | $V_A = 5\text{ V}$ , $I_{\text{OUT}} = 100\text{ }\mu\text{A}$   |                    | 5.4                |                    | mV                           |
| FSO                           | Full scale output            | $V_A = 3\text{ V}$ , $I_{\text{OUT}} = 10\text{ }\mu\text{A}$  |                    | 2.997              |                    | V                            |
|                               |                              | $V_A = 3\text{ V}$ , $I_{\text{OUT}} = 100\text{ }\mu\text{A}$   |                    | 2.99               |                    | V                            |
|                               |                              | $V_A = 5\text{ V}$ , $I_{\text{OUT}} = 10\text{ }\mu\text{A}$  |                    | 4.995              |                    | V                            |
|                               |                              | $V_A = 5\text{ V}$ , $I_{\text{OUT}} = 100\text{ }\mu\text{A}$   |                    | 4.992              |                    | V                            |
|                               | Maximum load capacitance     | $R_L = \infty$   |                    | 1500               |                    | pF                           |
|                               |                              | $R_L = 2\text{ k}\Omega$   |                    | 1500               |                    | pF                           |
|                               | DC output Impedance          |  |                    | 1.3                |                    | $\Omega$                     |
| $I_{\text{OS}}$               | Output short circuit current | $V_A = 5\text{ V}$ , $V_{\text{OUT}} = 0\text{ V}$ , Input code = 3FFh   |                    | -63                |                    | mA                           |
|                               |                              | $V_A = 3\text{ V}$ , $V_{\text{OUT}} = 0\text{ V}$ , Input code = 3FFh   |                    | -50                |                    | mA                           |
|                               |                              | $V_A = 5\text{ V}$ , $V_{\text{OUT}} = 5\text{ V}$ , Input code = 000h   |                    | 74                 |                    | mA                           |
|                               |                              | $V_A = 3\text{ V}$ , $V_{\text{OUT}} = 3\text{ V}$ , Input code = 000h   |                    | 53                 |                    | mA                           |

 (1) Typical figures are at  $T_J = 25^\circ\text{C}$ , and represent most likely parametric norms. Test limits are specified to TI's AOQL (Average Outgoing Quality Level).

(2) This parameter is ensured by design and/or characterization and is not tested in production.

## Electrical Characteristics (continued)

The following specifications apply for  $V_A = +2.7\text{ V}$  to  $+5.5\text{ V}$ ,  $R_L = 2\text{ k}\Omega$  to GND,  $C_L = 200\text{ pF}$  to GND,  $f_{SCLK} = 30\text{ MHz}$ , input code range 12 to 1011,  $T_A = 25^\circ\text{C}$ , unless otherwise specified.

| PARAMETER                                      | TEST CONDITIONS  |   | MIN <sup>(1)</sup>   | TYP <sup>(1)</sup>   | MAX <sup>(1)</sup> | UNIT          |
|--|--|---|--|--|--------------------|---------------|
| <b>LOGIC INPUT</b>                             |  |   |  |  |                    |               |
| $I_{IN}$                                       | Input current <sup>(2)</sup>   | DAC101S101: $-40^\circ\text{C} \leq T_A \leq +105^\circ\text{C}$ , DAC101S101Q: $-40^\circ\text{C} \leq T_A \leq +125^\circ\text{C}$                      | -1   |  | 1                  | $\mu\text{A}$ |
| $V_{IL}$                                       | Input low voltage <sup>(2)</sup>   | $V_A = 5\text{ V}$ , DAC101S101: $-40^\circ\text{C} \leq T_A \leq +105^\circ\text{C}$ , DAC101S101Q: $-40^\circ\text{C} \leq T_A \leq +125^\circ\text{C}$ |  |  | 0.8                | V             |
|  |  | $V_A = 3\text{ V}$ , DAC101S101: $-40^\circ\text{C} \leq T_A \leq +105^\circ\text{C}$ , DAC101S101Q: $-40^\circ\text{C} \leq T_A \leq +125^\circ\text{C}$ |  |  | 0.5                | V             |
| $V_{IH}$                                       | Input high voltage <sup>(2)</sup>  | $V_A = 5\text{ V}$ , DAC101S101: $-40^\circ\text{C} \leq T_A \leq +105^\circ\text{C}$ , DAC101S101Q: $-40^\circ\text{C} \leq T_A \leq +125^\circ\text{C}$ | 2.4  |  |                    | V             |
|  |  | $V_A = 3\text{ V}$ , DAC101S101: $-40^\circ\text{C} \leq T_A \leq +105^\circ\text{C}$ , DAC101S101Q: $-40^\circ\text{C} \leq T_A \leq +125^\circ\text{C}$ | 2.1  |  |                    | V             |
| $C_{IN}$                                       | Input capacitance <sup>(2)</sup>   | DAC101S101: $-40^\circ\text{C} \leq T_A \leq +105^\circ\text{C}$ , DAC101S101Q: $-40^\circ\text{C} \leq T_A \leq +125^\circ\text{C}$                      |  |  | 3                  | pF            |
| <b>POWER REQUIREMENTS</b>                      |  |   |  |  |                    |               |
| $I_A$  | Supply current (output unloaded)   | Normal Mode<br>$f_{SCLK} = 30\text{ MHz}$   | $V_A = 5.5\text{ V}$   |  | 256                | $\mu\text{A}$ |
|  |  |   |  | DAC101S101: $-40^\circ\text{C} \leq T_A \leq +105^\circ\text{C}$ , DAC101S101Q: $-40^\circ\text{C} \leq T_A \leq +125^\circ\text{C}$ | 332                |               |
|  |  | $V_A = 3.6\text{ V}$  |  | 174  | $\mu\text{A}$      |               |
|  |  |   | DAC101S101: $-40^\circ\text{C} \leq T_A \leq +105^\circ\text{C}$ , DAC101S101Q: $-40^\circ\text{C} \leq T_A \leq +125^\circ\text{C}$ | 226  |                    |               |
|  |  | Normal Mode<br>$f_{SCLK} = 20\text{ MHz}$   | $V_A = 5.5\text{ V}$   |  | 221                | $\mu\text{A}$ |
|  |  |   |  | DAC101S101: $-40^\circ\text{C} \leq T_A \leq +105^\circ\text{C}$ , DAC101S101Q: $-40^\circ\text{C} \leq T_A \leq +125^\circ\text{C}$ | 297                |               |
|  |  | $V_A = 3.6\text{ V}$  |  | 154  | $\mu\text{A}$      |               |
|  |  |   | DAC101S101: $-40^\circ\text{C} \leq T_A \leq +105^\circ\text{C}$ , DAC101S101Q: $-40^\circ\text{C} \leq T_A \leq +125^\circ\text{C}$ | 207  |                    |               |
|  |  | Normal Mode<br>$f_{SCLK} = 0$   | $V_A = 5.5\text{ V}$   |  | 145                | $\mu\text{A}$ |
|  |  |   | $V_A = 3.6\text{ V}$   |  | 113                |               |
|  |  | All PD Modes,<br>$f_{SCLK} = 30\text{ MHz}$   | $V_A = 5\text{ V}$   |  | 83                 | $\mu\text{A}$ |
|  |  |   | $V_A = 3\text{ V}$   |  | 42                 |               |
|  |  | All PD Modes,<br>$f_{SCLK} = 20\text{ MHz}$   | $V_A = 5\text{ V}$   |  | 56                 | $\mu\text{A}$ |
|  |  |   | $V_A = 3\text{ V}$   |  | 28                 |               |
| All PD Modes,<br>$f_{SCLK} = 0$ <sup>(2)</sup> | $V_A = 5.5\text{ V}$   |   | 0.06   | $\mu\text{A}$  |                    |               |
|  |  | DAC101S101: $-40^\circ\text{C} \leq T_A \leq +105^\circ\text{C}$ , DAC101S101Q: $-40^\circ\text{C} \leq T_A \leq +125^\circ\text{C}$                      | 1  |  |                    |               |
| $V_A = 3.6\text{ V}$                           |  | 0.04  | $\mu\text{A}$  |  |                    |               |
|  | DAC101S101: $-40^\circ\text{C} \leq T_A \leq +105^\circ\text{C}$ , DAC101S101Q: $-40^\circ\text{C} \leq T_A \leq +125^\circ\text{C}$ | 1   |  |  |                    |               |

**Electrical Characteristics (continued)**

The following specifications apply for  $V_A = +2.7\text{ V}$  to  $+5.5\text{ V}$ ,  $R_L = 2\text{ k}\Omega$  to GND,  $C_L = 200\text{ pF}$  to GND,  $f_{\text{SCLK}} = 30\text{ MHz}$ , input code range 12 to 1011,  $T_A = 25^\circ\text{C}$ , unless otherwise specified.

| PARAMETER                                 | TEST CONDITIONS                                       |                                 | MIN <sup>(1)</sup>  | TYP <sup>(1)</sup> | MAX <sup>(1)</sup> | UNIT          |
|---|---|---------------------------------|---|--------------------|--------------------|---------------|
| $P_C$ Power consumption (output unloaded) | Normal Mode<br>$f_{\text{SCLK}} = 30\text{ MHz}$      | $V_A = 5.5\text{ V}$            | DAC101S101: $-40^\circ\text{C} \leq T_A \leq +105^\circ\text{C}$ ,<br>DAC101S101Q: $-40^\circ\text{C} \leq T_A \leq +125^\circ\text{C}$ |                    | 1.41               | mW            |
|   |   | $V_A = 3.6\text{ V}$            | DAC101S101: $-40^\circ\text{C} \leq T_A \leq +105^\circ\text{C}$ ,<br>DAC101S101Q: $-40^\circ\text{C} \leq T_A \leq +125^\circ\text{C}$ |                    | 0.63               |               |
|   | Normal Mode<br>$f_{\text{SCLK}} = 20\text{ MHz}$      | $V_A = 5.5\text{ V}$            | DAC101S101: $-40^\circ\text{C} \leq T_A \leq +105^\circ\text{C}$ ,<br>DAC101S101Q: $-40^\circ\text{C} \leq T_A \leq +125^\circ\text{C}$ |                    | 1.22               | mW            |
|   |   | $V_A = 3.6\text{ V}$            | DAC101S101: $-40^\circ\text{C} \leq T_A \leq +105^\circ\text{C}$ ,<br>DAC101S101Q: $-40^\circ\text{C} \leq T_A \leq +125^\circ\text{C}$ |                    | 0.55               |               |
|   | Normal Mode<br>$f_{\text{SCLK}} = 0$                  | $V_A = 5.5\text{ V}$            |   |                    | 0.8                | $\mu\text{W}$ |
|   |   | $V_A = 3.6\text{ V}$            |   |                    | 0.41               | $\mu\text{W}$ |
|   | All PD Modes,<br>$f_{\text{SCLK}} = 30\text{ MHz}$    | $V_A = 5\text{ V}$              |   |                    | 0.42               | $\mu\text{W}$ |
|   |   | $V_A = 3\text{ V}$              |   |                    | 0.13               | $\mu\text{W}$ |
|   | All PD Modes,<br>$f_{\text{SCLK}} = 20\text{ MHz}$    | $V_A = 5\text{ V}$              |   |                    | 0.28               | $\mu\text{W}$ |
|   |   | $V_A = 3\text{ V}$              |   |                    | 0.08               | $\mu\text{W}$ |
|   | All PD Modes,<br>$f_{\text{SCLK}} = 0$ <sup>(2)</sup> | $V_A = 5.5\text{ V}$            | DAC101S101: $-40^\circ\text{C} \leq T_A \leq +105^\circ\text{C}$ ,<br>DAC101S101Q: $-40^\circ\text{C} \leq T_A \leq +125^\circ\text{C}$ |                    | 0.33               | $\mu\text{W}$ |
|   |   | $V_A = 3.6\text{ V}$            | DAC101S101: $-40^\circ\text{C} \leq T_A \leq +105^\circ\text{C}$ ,<br>DAC101S101Q: $-40^\circ\text{C} \leq T_A \leq +125^\circ\text{C}$ |                    | 0.14               |               |
|   | $I_{\text{OUT}} / I_A$ Power efficiency               | $I_{\text{LOAD}} = 2\text{ mA}$ | $V_A = 5\text{ V}$  |                    | 91%                |               |
| $V_A = 3\text{ V}$                        |   |                                 |   | 94%                |                    |               |

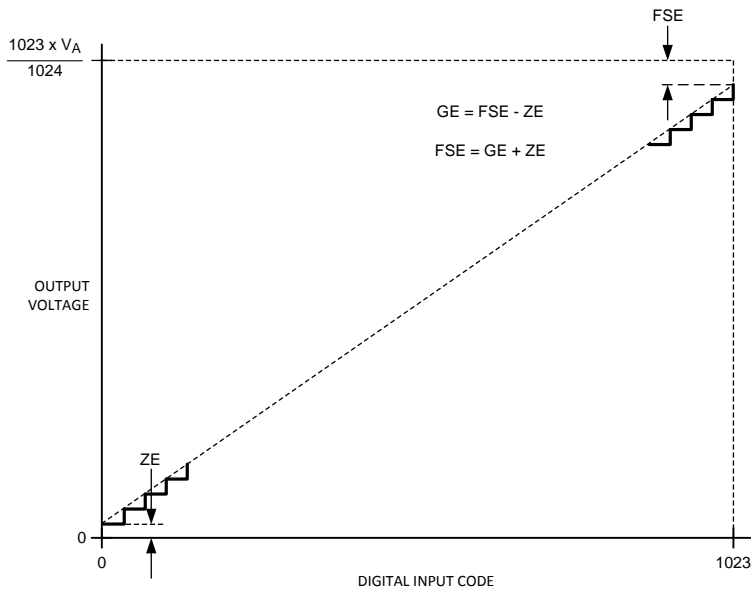


## 7.7 A.C. and Timing Requirements

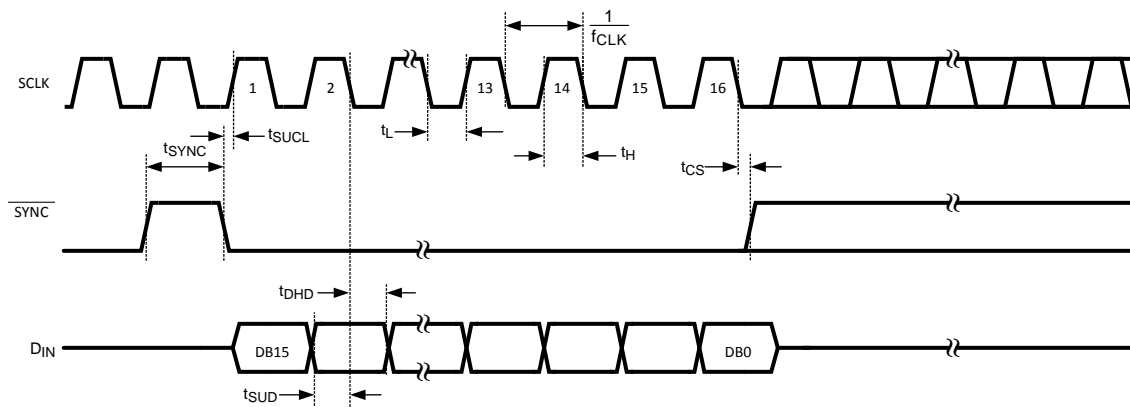
The following specifications apply for  $V_A = +2.7\text{ V}$  to  $+5.5\text{ V}$ ,  $R_L = 2\text{ k}\Omega$  to GND,  $C_L = 200\text{ pF}$  to GND,  $f_{\text{SCLK}} = 30\text{ MHz}$ , input code range 12 to 1011,  $T_A = 25^\circ\text{C}$ , unless otherwise specified.

|                     |  |   | MIN <sup>(1)</sup>       | TYP <sup>(1)</sup>  | MAX <sup>(1)</sup> | UNIT             |
|---------------------|--|---|--------------------------|---|--------------------|------------------|
| $f_{\text{SCLK}}$   | SCLK Frequency   | DAC101S101: $-40^\circ\text{C} \leq T_A \leq +105^\circ\text{C}$ ,<br>DAC101S101Q: $-40^\circ\text{C} \leq T_A \leq +125^\circ\text{C}$ |                          |   | 30                 | MHz              |
| $t_s$               | Output voltage settling time <sup>(2)</sup>              | 100h to 300h code change,<br>$R_L = 2\text{ k}\Omega$   | $C_L \leq 200\text{ pF}$ | DAC101S101: $-40^\circ\text{C} \leq T_A \leq +105^\circ\text{C}$ ,<br>DAC101S101Q: $-40^\circ\text{C} \leq T_A \leq +125^\circ\text{C}$ |                    | $\mu\text{s}$    |
|                     |  |   |                          |   | 5                  |                  |
| SR                  | Output slew rate   |   |                          | 1   |                    | V/ $\mu\text{s}$ |
|                     | Glitch impulse   | Code change from 200h to 1FFh   |                          |   | 12                 | nV-sec           |
|                     | Digital feedthrough                                      |   |                          |   | 0.5                | nV-sec           |
| $t_{\text{WU}}$     | Wake-up time   | $V_A = 5\text{ V}$  |                          |   | 6                  | $\mu\text{s}$    |
|                     |  | $V_A = 3\text{ V}$  |                          |   | 39                 | $\mu\text{s}$    |
| $1/f_{\text{SCLK}}$ | SCLK Cycle time  | DAC101S101: $-40^\circ\text{C} \leq T_A \leq +105^\circ\text{C}$ ,<br>DAC101S101Q: $-40^\circ\text{C} \leq T_A \leq +125^\circ\text{C}$ |                          | 33  |                    | ns               |
| $t_H$               | SCLK High time   | DAC101S101: $-40^\circ\text{C} \leq T_A \leq +105^\circ\text{C}$ ,<br>DAC101S101Q: $-40^\circ\text{C} \leq T_A \leq +125^\circ\text{C}$ |                          |   | 5                  | ns               |
|                     |  |   | 13                       |   |                    |                  |
| $t_L$               | SCLK Low time  | DAC101S101: $-40^\circ\text{C} \leq T_A \leq +105^\circ\text{C}$ ,<br>DAC101S101Q: $-40^\circ\text{C} \leq T_A \leq +125^\circ\text{C}$ |                          |   | 5                  | ns               |
|                     |  |   | 13                       |   |                    |                  |
| $t_{\text{SUCL}}$   | Set-up time $\overline{\text{SYNC}}$ to SCLK rising edge |   |                          |   | -15                | ns               |
|                     |  | DAC101S101: $-40^\circ\text{C} \leq T_A \leq +105^\circ\text{C}$ ,<br>DAC101S101Q: $-40^\circ\text{C} \leq T_A \leq +125^\circ\text{C}$ |                          |   | 0                  |                  |
| $t_{\text{SUD}}$    | Data set-up time   | DAC101S101: $-40^\circ\text{C} \leq T_A \leq +105^\circ\text{C}$ ,<br>DAC101S101Q: $-40^\circ\text{C} \leq T_A \leq +125^\circ\text{C}$ |                          |   | 2.5                | ns               |
|                     |  |   | 5                        |   |                    |                  |
| $t_{\text{DHD}}$    | Data hold time   | DAC101S101: $-40^\circ\text{C} \leq T_A \leq +105^\circ\text{C}$ ,<br>DAC101S101Q: $-40^\circ\text{C} \leq T_A \leq +125^\circ\text{C}$ |                          |   | 2.5                | ns               |
|                     |  |   | 4.5                      |   |                    |                  |
| $t_{\text{CS}}$     | SCLK fall to rise of SYNC                                | $V_A = 5\text{ V}$  |                          |   | 0                  | ns               |
|                     |  | DAC101S101: $-40^\circ\text{C} \leq T_A \leq +105^\circ\text{C}$ ,<br>DAC101S101Q: $-40^\circ\text{C} \leq T_A \leq +125^\circ\text{C}$ |                          |   | 3                  |                  |
|                     |  | $V_A = 3\text{ V}$  |                          |   | -2                 | ns               |
|                     |  | DAC101S101: $-40^\circ\text{C} \leq T_A \leq +105^\circ\text{C}$ ,<br>DAC101S101Q: $-40^\circ\text{C} \leq T_A \leq +125^\circ\text{C}$ |                          |   | 1                  |                  |
| $t_{\text{SYNC}}$   | $\overline{\text{SYNC}}$ High time                       | $2.7 \leq V_A \leq 3.6$   |                          |   | 9                  | ns               |
|                     |  | DAC101S101: $-40^\circ\text{C} \leq T_A \leq +105^\circ\text{C}$ ,<br>DAC101S101Q: $-40^\circ\text{C} \leq T_A \leq +125^\circ\text{C}$ |                          |   | 20                 |                  |
|                     |  | $3.6 \leq V_A \leq 5.5$   |                          |   | 5                  | ns               |
|                     |  | DAC101S101: $-40^\circ\text{C} \leq T_A \leq +105^\circ\text{C}$ ,<br>DAC101S101Q: $-40^\circ\text{C} \leq T_A \leq +125^\circ\text{C}$ |                          |   | 10                 |                  |

- (1) Typical figures are at  $T_J = 25^\circ\text{C}$ , and represent most likely parametric norms. Test limits are specified to TI's AOQL (Average Outgoing Quality Level).
- (2) This parameter is ensured by design and/or characterization and is not tested in production.



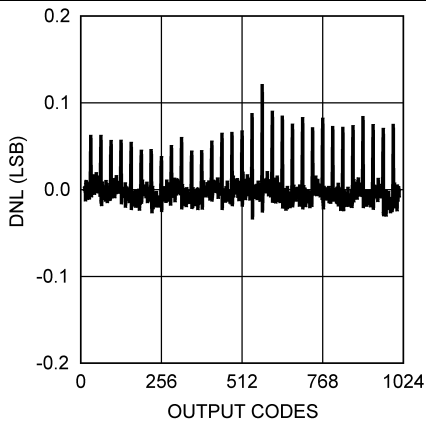
**Figure 1. Input / Output Transfer Characteristic**



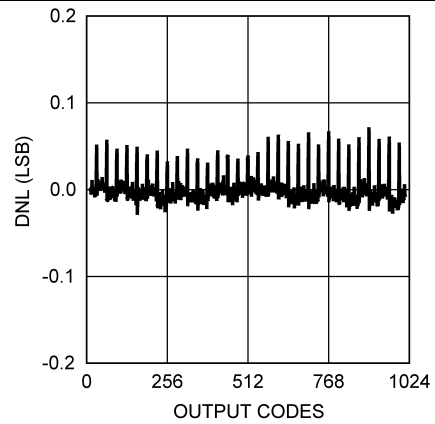
**Figure 2. Serial Timing Diagram**

### 7.8 Typical Characteristics

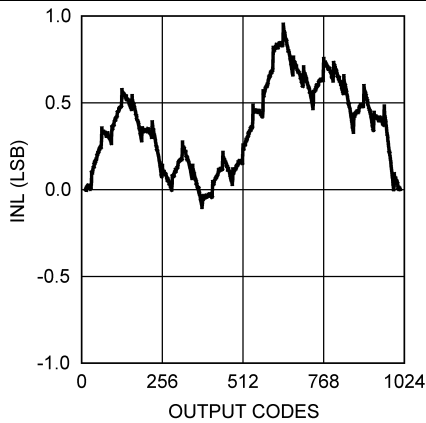
$f_{SCLK} = 30 \text{ MHz}$ ,  $T_A = 25^\circ\text{C}$ , Input Code Range 12 to 1011, unless otherwise stated



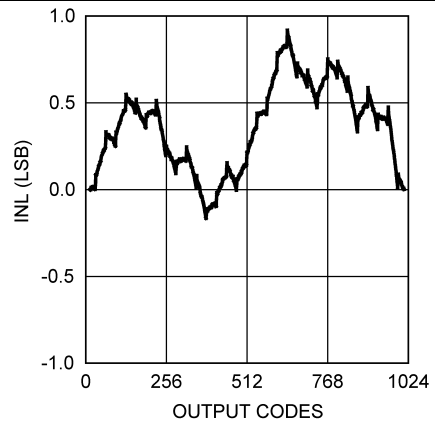
**Figure 3. DNL at  $V_A = 3 \text{ V}$**



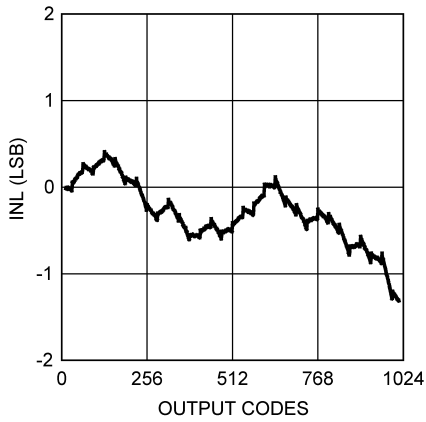
**Figure 4. DNL at  $V_A = 5 \text{ V}$**



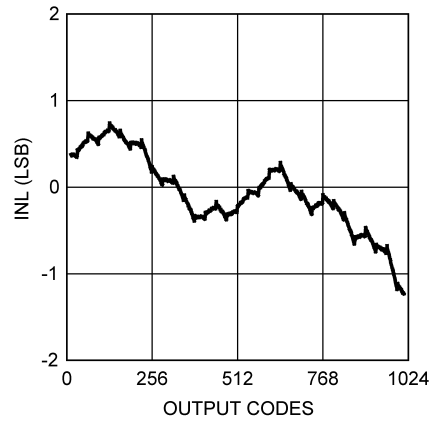
**Figure 5. INL at  $V_A = 3 \text{ V}$**



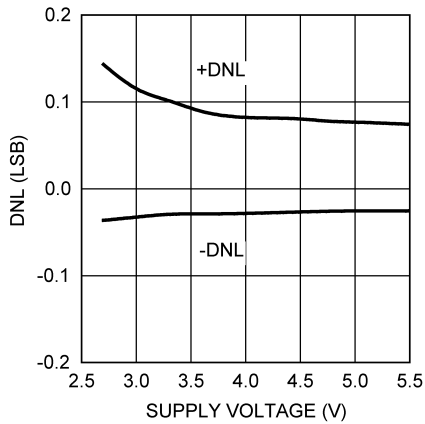
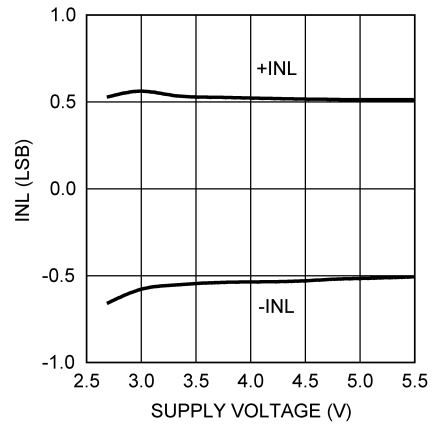
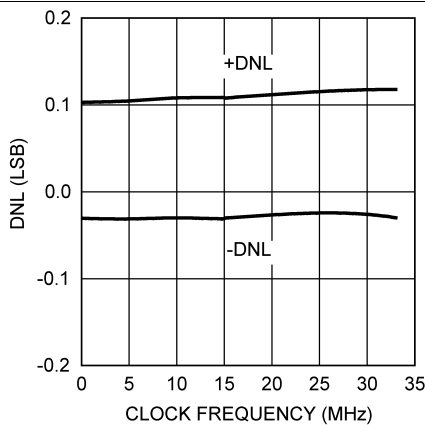
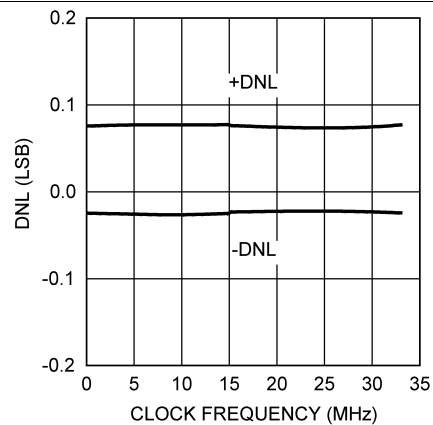
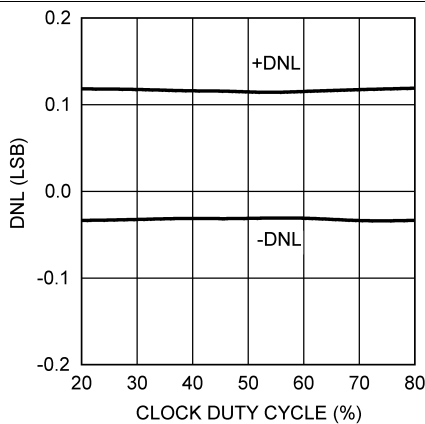
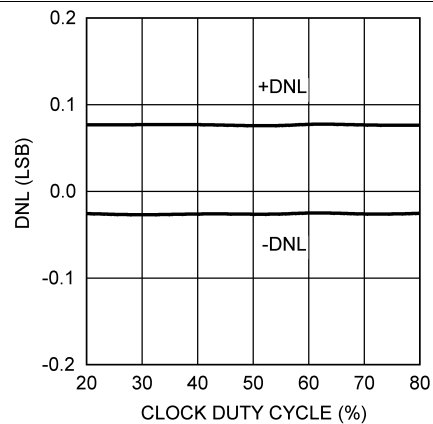
**Figure 6. INL at  $V_A = 5 \text{ V}$**



**Figure 7. TUE at  $V_A = 3 \text{ V}$**

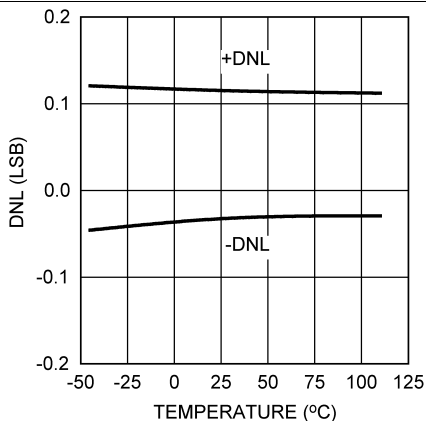


**Figure 8. TUE at  $V_A = 5 \text{ V}$**

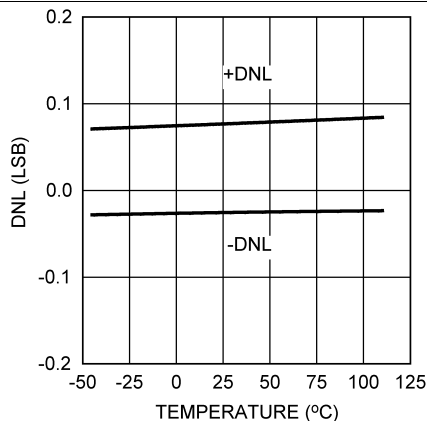
**Typical Characteristics (continued)**
 $f_{SCLK} = 30 \text{ MHz}$ ,  $T_A = 25^\circ\text{C}$ , Input Code Range 12 to 1011, unless otherwise stated

**Figure 9. DNL vs.  $V_A$** 

**Figure 10. INL vs.  $V_A$** 

**Figure 11. 3-V DNL vs.  $f_{SCLK}$** 

**Figure 12. 5-V DNL vs.  $f_{SCLK}$** 

**Figure 13. 3-V DNL vs. Clock Duty Cycle**

**Figure 14. 5-V DNL vs. Clock Duty Cycle**

**Typical Characteristics (continued)**

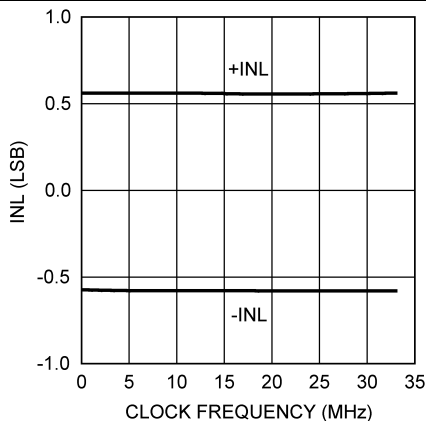
$f_{SCLK} = 30 \text{ MHz}$ ,  $T_A = 25^\circ\text{C}$ , Input Code Range 12 to 1011, unless otherwise stated



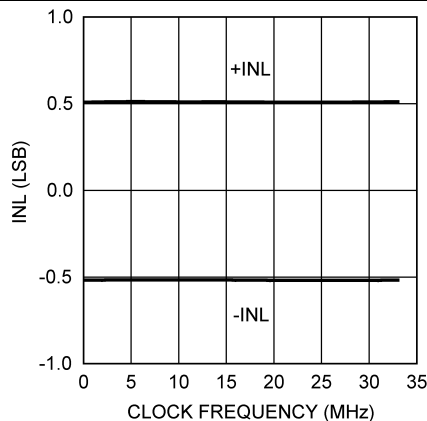
**Figure 15. 3-V DNL vs. Temperature**



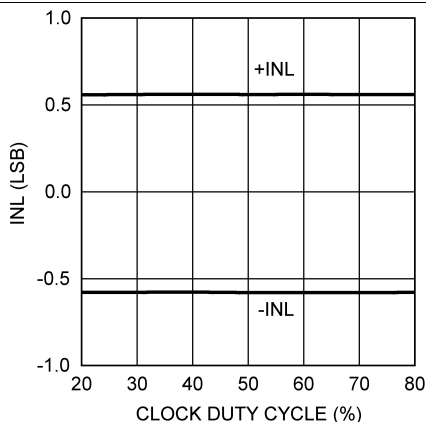
**Figure 16. 5-V DNL vs. Temperature**



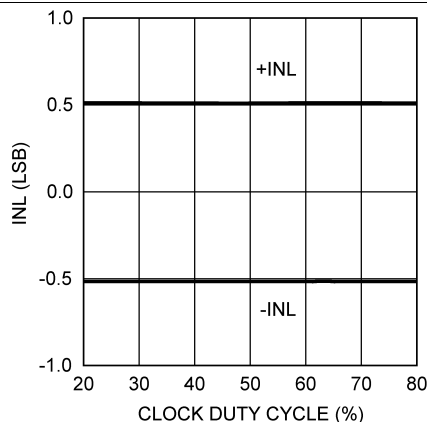
**Figure 17. 3-V INL vs.  $f_{SCLK}$**



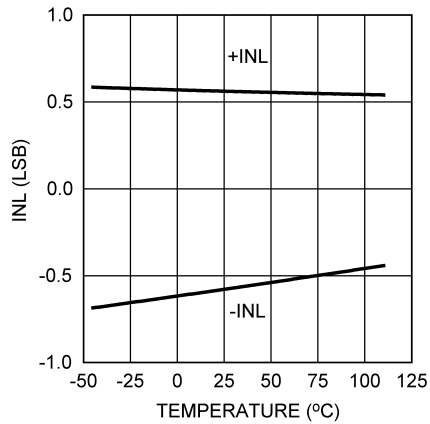
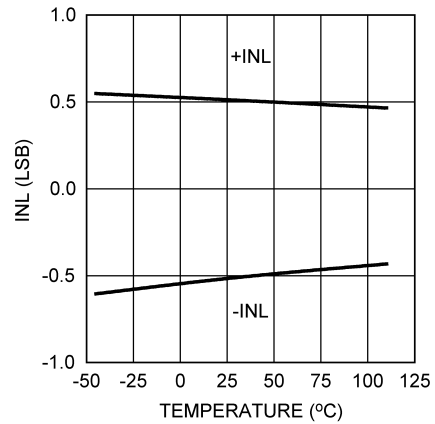
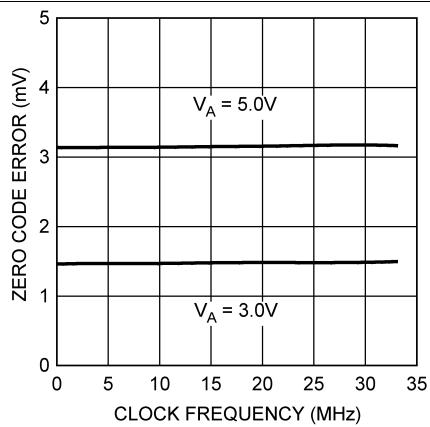
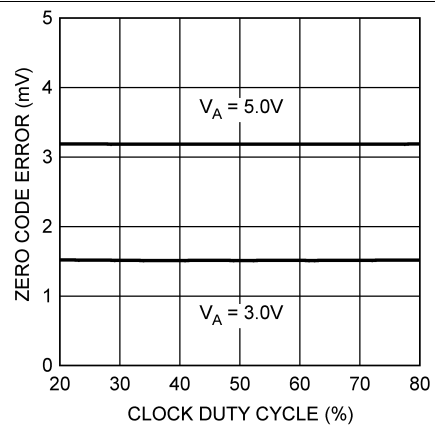
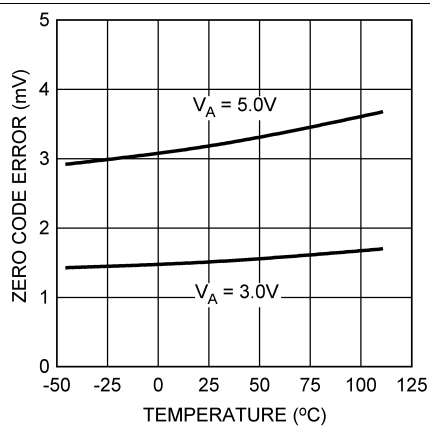
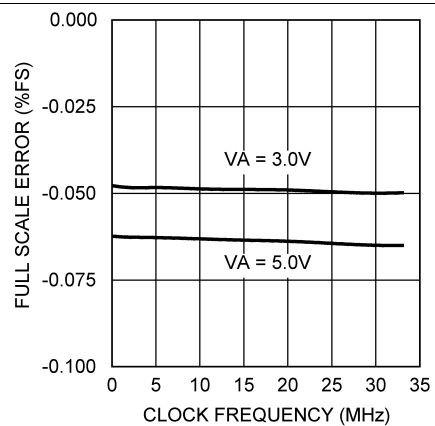
**Figure 18. 5-V INL vs.  $f_{SCLK}$**



**Figure 19. 3-V INL vs. Clock Duty Cycle**



**Figure 20. 5-V INL vs. Clock Duty Cycle**

**Typical Characteristics (continued)**
 $f_{SCLK} = 30 \text{ MHz}$ ,  $T_A = 25^\circ\text{C}$ , Input Code Range 12 to 1011, unless otherwise stated

**Figure 21. 3-V INL vs. Temperature**

**Figure 22. 5-V INL vs. Temperature**

**Figure 23. Zero Code Error vs.  $f_{SCLK}$** 

**Figure 24. Zero Code Error vs. Clock Duty Cycle**

**Figure 25. Zero Code Error vs. Temperature**

**Figure 26. Full-Scale Error vs.  $f_{SCLK}$**

Typical Characteristics (continued)

$f_{SCLK} = 30 \text{ MHz}$ ,  $T_A = 25^\circ\text{C}$ , Input Code Range 12 to 1011, unless otherwise stated

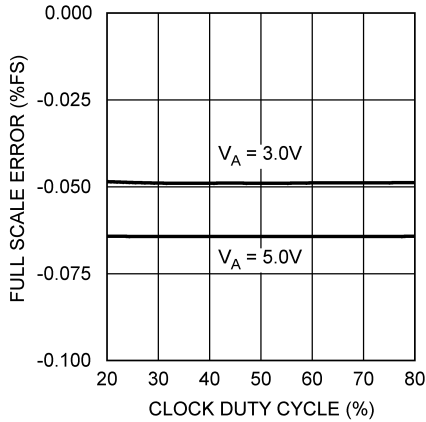


Figure 27. Full-Scale Error vs. Clock Duty Cycle

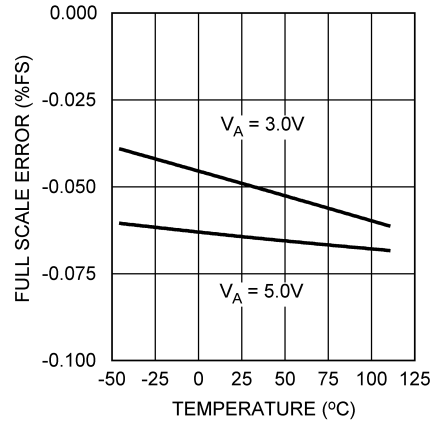


Figure 28. Full-Scale Error vs. Temperature

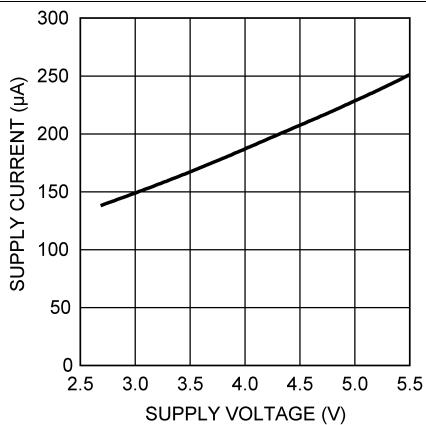


Figure 29. Supply Current vs.  $V_A$

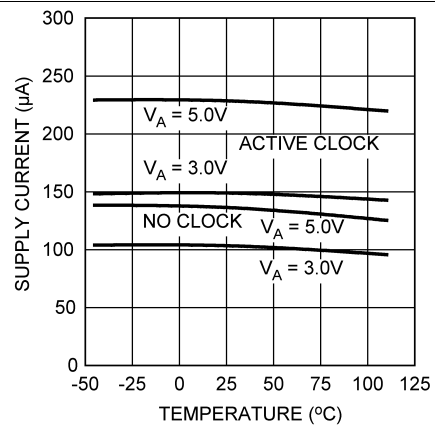


Figure 30. Supply Current vs. Temperature

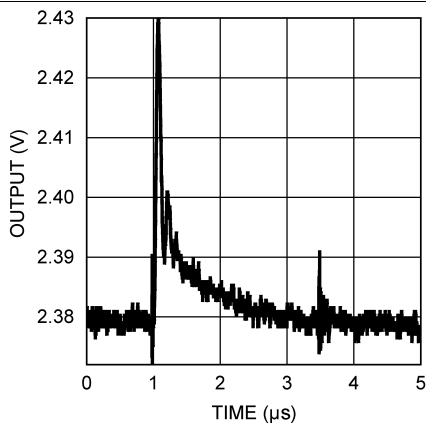


Figure 31. 5-V Glitch Response

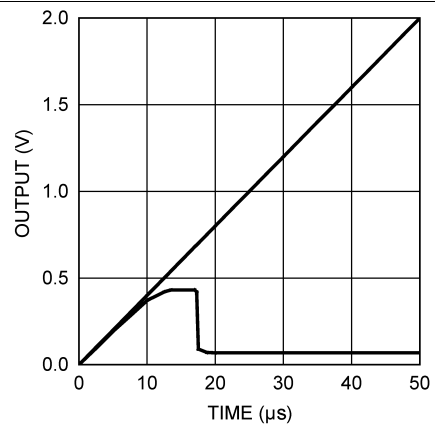
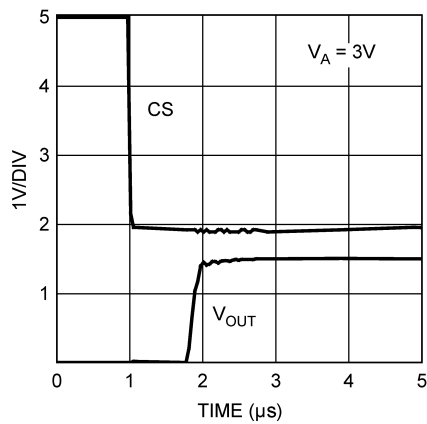
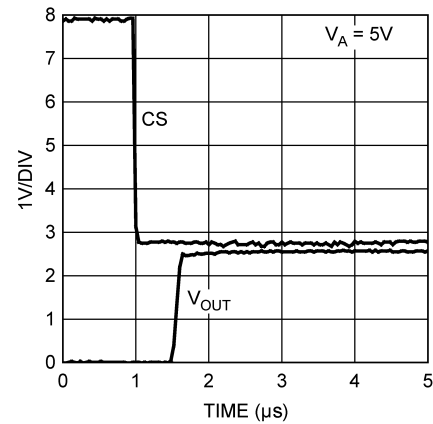


Figure 32. Power-On Reset

**Typical Characteristics (continued)**
 $f_{SCLK} = 30 \text{ MHz}$ ,  $T_A = 25^\circ\text{C}$ , Input Code Range 12 to 1011, unless otherwise stated

**Figure 33. 3-V Wake-Up Time**

**Figure 34. 5-V Wake-Up Time**



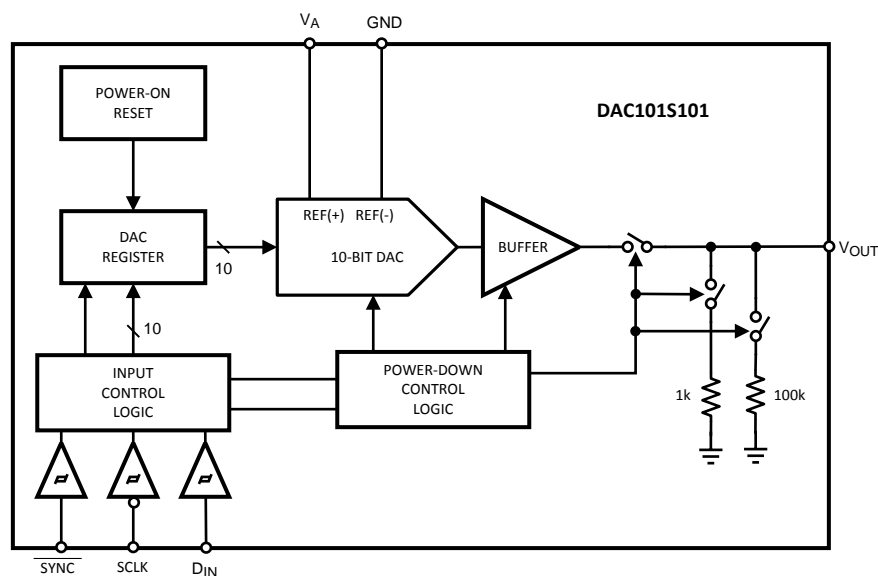
## 8 Detailed Description

### 8.1 Overview

The DAC101S101 is a full-featured, general purpose 10-bit voltage-output digital-to-analog converter (DAC) that can operate from a single +2.7 V to 5.5 V supply and consumes just 175  $\mu$ A of current at 3.6 Volts. The on-chip output amplifier allows rail-to-rail output swing and the three wire serial interface operates at clock rates up to 30 MHz over the specified supply voltage range and is compatible with standard SPI, QSPI, MICROWIRE and DSP interfaces.

The supply voltage for the DAC101S101 serves as its voltage reference, providing the widest possible output dynamic range. A power-on reset circuit ensures that the DAC output powers up to zero volts and remains there until there is a valid write to the device. A power-down feature reduces power consumption to less than a microWatt.

### 8.2 Functional Block Diagram



### 8.3 Feature Description

#### 8.3.1 DAC Section

The DAC101S101 is fabricated on a CMOS process with an architecture that consists of a resistor string and switches that are followed by an output buffer. The power supply serves as the reference voltage. The input coding is straight binary with an ideal output voltage of:

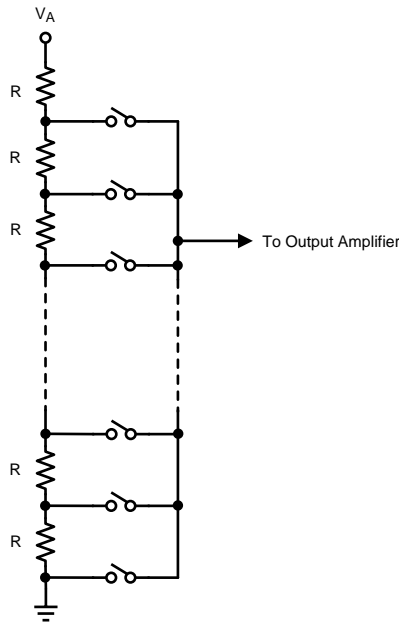
$$V_{OUT} = V_A \times (D / 1024)$$

where

- $D$  is the decimal equivalent of the binary code that is loaded into the DAC register and can take on any value between 0 and 1023 (1)

#### 8.3.2 Resistor String

The resistor string is shown in [Figure 35](#). This string consists of 1024 equal valued resistors in series with a switch at each junction of two resistors, plus a switch to ground. The code loaded into the DAC register determines which switch is closed, connecting the proper node to the amplifier. This configuration ensures that the DAC is monotonic.

**Feature Description (continued)**

**Figure 35. DAC Resistor String**
**8.3.3 Output Amplifier**

The output buffer amplifier is a rail-to-rail type, providing an output voltage range of 0V to  $V_A$ . All amplifiers, even rail-to-rail types, exhibit a loss of linearity as the output approaches the supply rails (0V and  $V_A$ , in this case). For this reason, linearity is specified over less than the full output range of the DAC. The output capabilities of the amplifier are described in the [Electrical Characteristics](#) Tables.

**8.3.4 Power-On Reset**

The power-on reset circuit controls the output voltage during power-up. The DAC register is filled with zeros and the output voltage is 0 Volts and remains there until a valid write sequence is made to the DAC.

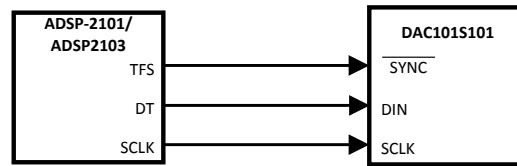
**8.4 Device Functional Modes**
**8.4.1 Power-Down Modes**

The DAC101S101 has four modes of operation. These modes are set with two bits (DB13 and DB12) in the control register.

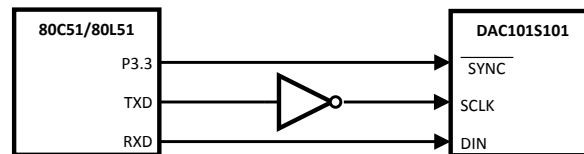
**Table 1. Modes of Operation**

| DB13 | DB12 | OPERATING MODE                        |
|------|------|---------------------------------------|
| 0    | 0    | Normal Operation                      |
| 0    | 1    | Power-Down with 1 k $\Omega$ to GND   |
| 1    | 0    | Power-Down with 100 k $\Omega$ to GND |
| 1    | 1    | Power-Down with Hi-Z                  |



**Programming (continued)**

**Figure 37. ADSP-2101/2103 Interface**
**8.5.3.2 80C51/80L51 Interface**

A serial interface between the DAC101S101 and the 80C51/80L51 microcontroller is shown in Figure 38. The SYNC signal comes from a bit-programmable pin on the microcontroller. The example shown here uses port line P3.3. This line is taken low when data is to be transmitted to the DAC101S101. Since the 80C51/80L51 transmits 8-bit bytes, only eight falling clock edges occur in the transmit cycle. To load data into the DAC, the P3.3 line must be left low after the first eight bits are transmitted. A second write cycle is initiated to transmit the second byte of data, after which port line P3.3 is brought high. The 80C51/80L51 transmit routine must recognize that the 80C51/80L51 transmits data with the LSB first while the DAC101S101 requires data with the MSB first.


**Figure 38. 80C51/80L51 Interface**
**8.5.3.3 68HC11 Interface**

A serial interface between the DAC101S101 and the 68HC11 microcontroller is shown in Figure 39. The SYNC line of the DAC101S101 is driven from a port line (PC7 in the figure), similar to the 80C51/80L51.

The 68HC11 should be configured with its CPOL bit as a zero and its CPHA bit as a one. This configuration causes data on the MOSI output to be valid on the falling edge of SCLK. PC7 is taken low to transmit data to the DAC. The 68HC11 transmits data in 8-bit bytes with eight falling clock edges. Data is transmitted with the MSB first. PC7 must remain low after the first eight bits are transferred. A second write cycle is initiated to transmit the second byte of data to the DAC, after which PC7 should be raised to end the write sequence.

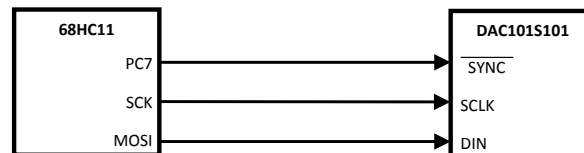
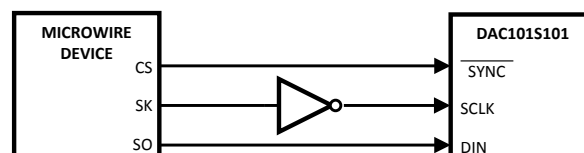

**Figure 39. 68HC11 Interface**
**8.5.3.4 Microwire Interface**

Figure 40 shows an interface between a Microwire compatible device and the DAC101S101. Data is clocked out on the rising edges of the SCLK signal.


**Figure 40. Microwire Interface**

## 9 Application and Implementation

### NOTE

Information in the following applications sections is not part of the TI component specification, and TI does not warrant its accuracy or completeness. TI's customers are responsible for determining suitability of components for their purposes. Customers should validate and test their design implementation to confirm system functionality.

### 9.1 Application Information

The DAC101S101 is designed for single supply operation and thus has a unipolar output. However, a bipolar output may be obtained with the circuit in Figure 41. This circuit will provide an output voltage range of  $\pm 5$  Volts. A rail-to-rail amplifier should be used if the amplifier supplies are limited to  $\pm 5$ V.

### 9.2 Typical Application

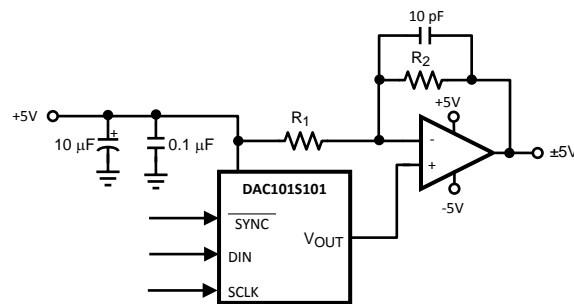


Figure 41. Bipolar Operation

#### 9.2.1 Design Requirements

- The DAC101S101 will use a single supply.
- The output is required to be bipolar with a voltage range of  $\pm 5$  V.
- Dual supplies will be used for the output amplifier.

#### 9.2.2 Detailed Design Procedure

The output voltage of this circuit for any code is found to be

$$V_O = (V_A \times (D / 1024) \times ((R1 + R2) / R1) - V_A \times R2 / R1)$$

where

- D is the input code in decimal form
- With  $V_A = 5$  V and  $R1 = R2$

$$V_O = (10 \times D / 1024) - 5V$$

(2)

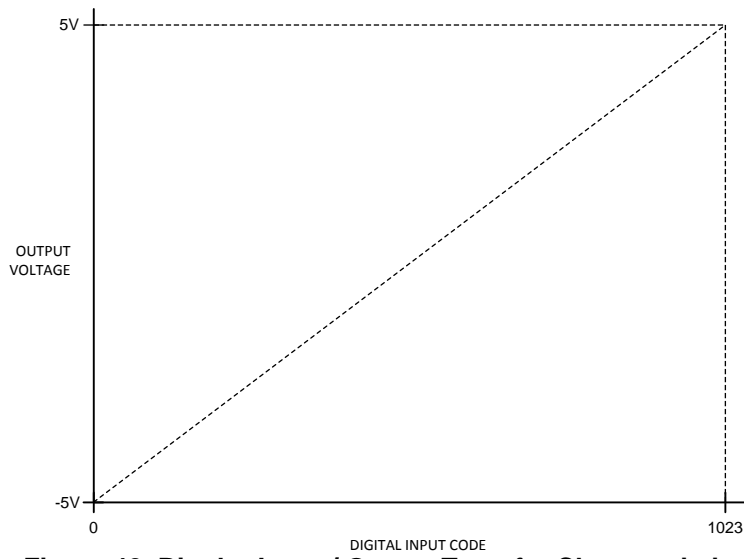
(3)

A list of rail-to-rail amplifiers suitable for this application are indicated in Table 2.

Table 2. Some Rail-To-Rail Amplifiers

| AMP     | PKGS               | Typ $V_{OS}$ | Typ $I_{SUPPLY}$ |
|---------|--------------------|--------------|------------------|
| LMC7111 | SOT-23-5           | 0.9 mV       | 25 $\mu$ A       |
| LM7301  | SOIC-8<br>SOT-23-5 | 0.03 mV      | 620 $\mu$ A      |
| LM8261  | SOT-23-5           | 0.7 mV       | 1 mA             |

**9.2.3 Application Curve**



**Figure 42. Bipolar Input / Output Transfer Characteristic**

## 10 Power Supply Recommendations

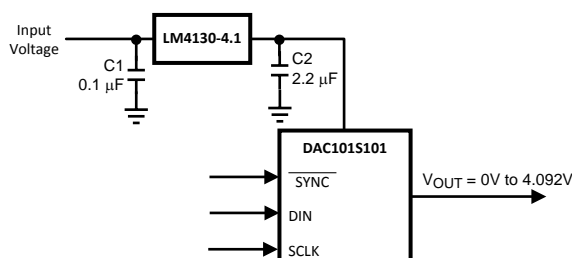
The simplicity of the DAC101S101 implies ease of use. However, it is important to recognize that any data converter that utilizes its supply voltage as its reference voltage will have essentially zero PSRR (Power Supply Rejection Ratio). Therefore, it is necessary to provide a noise-free supply voltage to the device.

### 10.1 Using References as Power Supplies

Since the DAC101S101 consumes very little power, a reference source may be used as the supply voltage. The advantages of using a reference source over a voltage regulator are accuracy and stability. Some low noise regulators can also be used for the power supply of the DAC101S101. Listed below are a few power supply options for the DAC101S101.

#### 10.1.1 LM4130

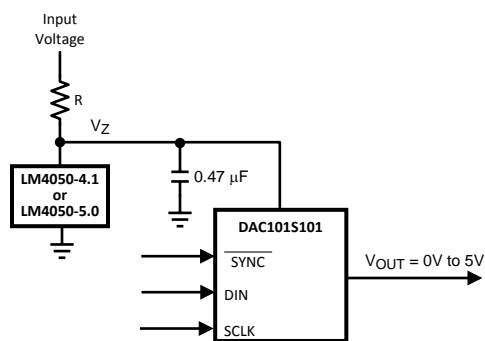
The LM4130 reference, with its 0.05% accuracy over temperature, is a good choice as a power source for the DAC101S101. Its primary disadvantage is the lack of a 3V and 5V versions. However, the 4.096V version is useful if a 0 to 4.095V output range is desirable or acceptable. Bypassing the VIN pin with a 0.1 $\mu$ F capacitor and the VOUT pin with a 2.2 $\mu$ F capacitor will improve stability and reduce output noise. The LM4130 comes in a space-saving 5-pin SOT-23.



**Figure 43. The LM4130 as a Power Supply**

#### 10.1.2 LM4050

Available with accuracy of 0.44%, the LM4050 shunt reference is also a good choice as a power regulator for the DAC101S101. It does not come in a 3 Volt version, but 4.096V and 5V versions are available. It comes in a space-saving 3-pin SOT-23.



**Figure 44. The LM4050 as a Power Supply**

The minimum resistor value in the circuit of [Figure 44](#) should be chosen such that the maximum current through the LM4050 does not exceed its 15 mA rating. The conditions for maximum current include the input voltage at its maximum, the LM4050 voltage at its minimum, the resistor value at its minimum due to tolerance, and the DAC101S101 draws zero current. The maximum resistor value must allow the LM4050 to draw more than its minimum current for regulation plus the maximum DAC101S101 current in full operation. The conditions for minimum current include the input voltage at its minimum, the LM4050 voltage at its maximum, the resistor value at its maximum due to tolerance, and the DAC101S101 draws its maximum current. These conditions can be summarized as

## Using References as Power Supplies (continued)

$$R(\text{min}) = (V_{\text{IN}}(\text{max}) - V_{\text{Z}}(\text{min}) / (I_{\text{A}}(\text{min}) + I_{\text{Z}}(\text{max}))$$

where

- $V_{\text{Z}}(\text{min})$  are the nominal LM4050 output voltages  $\pm$  the LM4050 output tolerance over temperature
  - $I_{\text{Z}}(\text{max})$  is the maximum allowable current through the LM4050
  - $I_{\text{A}}(\text{min})$  is the minimum DAC101S101 supply current
- (4)

and

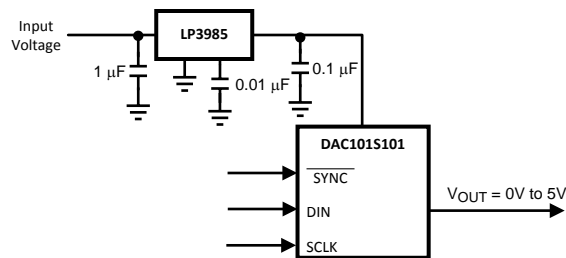
$$R(\text{max}) = (V_{\text{IN}}(\text{min}) - V_{\text{Z}}(\text{max}) / (I_{\text{A}}(\text{max}) + I_{\text{Z}}(\text{min}))$$

where

- $V_{\text{Z}}(\text{max})$  are the nominal LM4050 output voltages  $\pm$  the LM4050 output tolerance over temperature
  - $I_{\text{Z}}(\text{min})$  is the minimum current required by the LM4050 for proper regulation
  - $I_{\text{A}}(\text{max})$  is the maximum DAC101S101 supply current
- (5)

### 10.1.3 LP3985

The LP3985 is a low noise, ultra low dropout voltage regulator with a 3% accuracy over temperature. It is a good choice for applications that do not require a precision reference for the DAC101S101. It comes in 3.0V, 3.3V and 5V versions, among others, and sports a low 30  $\mu\text{V}$  noise specification at low frequencies. Because low frequency noise is relatively difficult to filter, this specification could be important for some applications. The LP3985 comes in a space-saving 5-pin SOT-23 and 5-bump micro SMD packages.

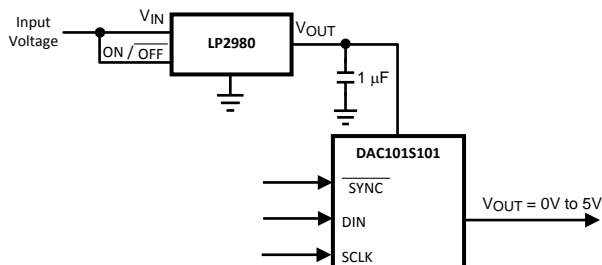


**Figure 45. Using The Lp3985 Regulator**

An input capacitance of 1  $\mu\text{F}$  without any ESR requirement is required at the LP3985 input, while a 1- $\mu\text{F}$  ceramic capacitor with an ESR requirement of 5 m $\Omega$  to 500 m $\Omega$  is required at the output. Careful interpretation and understanding of the capacitor specification is required to ensure correct device operation.

### 10.1.4 LP2980

The LP2980 is an ultra low dropout regulator with a 0.5% or 1.0% accuracy over temperature, depending upon grade. It is available in 3 V, 3.3 V and 5 V versions, among others.



**Figure 46. Using The Lp2980 Regulator**



## Using References as Power Supplies (continued)

Like any low dropout regulator, the LP2980 requires an output capacitor for loop stability. This output capacitor must be at least 1- $\mu$ F over temperature, but values of 2.2  $\mu$ F or more provide better performance. The ESR of this capacitor should be within the range specified in the LP2980 data sheet. Surface-mount solid tantalum capacitors offer a good combination of small size and ESR. Ceramic capacitors are attractive due to their small size but generally have ESR values that are too low for use with the LP2980. Aluminum electrolytic capacitors are typically not a good choice due to their large size and have ESR values that may be too high at low temperatures.

## 11 Layout

### 11.1 Layout Guidelines

For best accuracy and minimum noise, the printed circuit board containing the DAC101S101 should have separate analog and digital areas. The areas are defined by the locations of the analog and digital power planes. Both of these planes should be located in the same board layer. There should be a single ground plane. A single ground plane is preferred if digital return current does not flow through the analog ground area. Frequently a single ground plane design will utilize a "fencing" technique to prevent the mixing of analog and digital ground current. Separate ground planes should only be utilized when the fencing technique is inadequate. The separate ground planes must be connected in one place, preferably near the DAC101S101. Special care is required to ensure that digital signals with fast edge rates do not pass over split ground planes. They must always have a continuous return path below their traces.

The DAC101S101 power supply should be bypassed with a 10- $\mu$ F and a 0.1- $\mu$ F capacitor as close as possible to the device with the 0.1- $\mu$ F right at the device supply pin. The 10- $\mu$ F capacitor should be a tantalum type and the 0.1- $\mu$ F capacitor should be a low ESL, low ESR type. The power supply for the DAC101S101 should only be used for analog circuits.

Avoid crossover of analog and digital signals and keep the clock and data lines on the component side of the board. The clock and data lines should have controlled impedances.

### 11.2 Layout Example

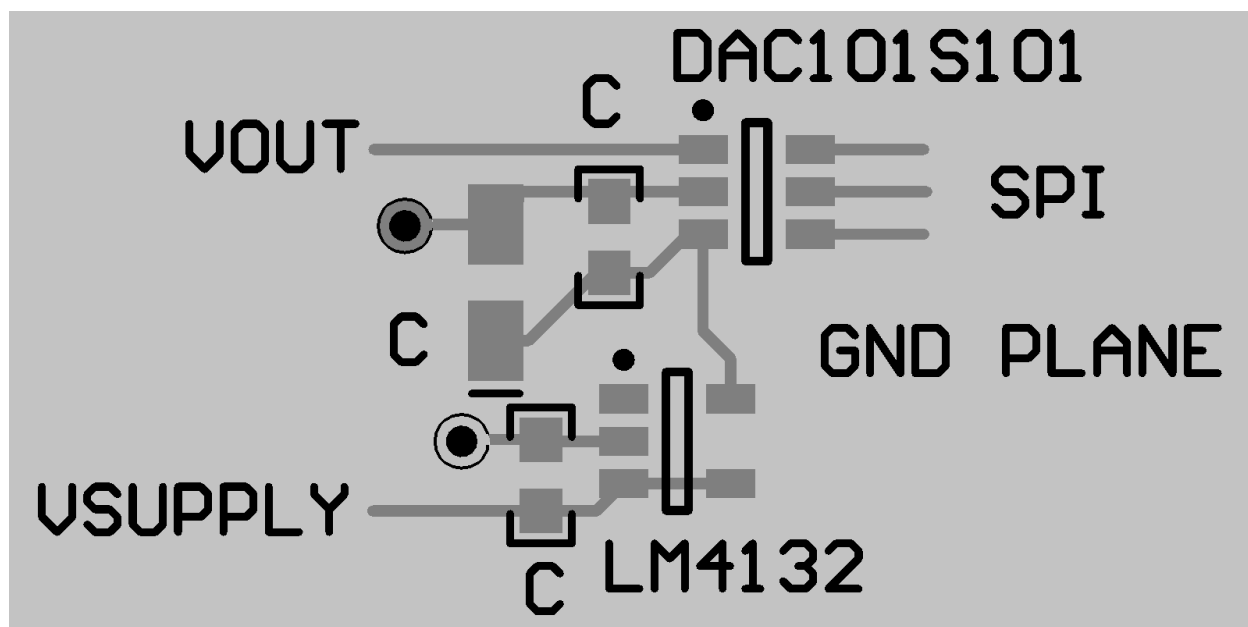


Figure 47. Layout Example

## 12 Device and Documentation Support

### 12.1 Device Support

#### 12.1.1 Device Nomenclature

**DIFFERENTIAL NON-LINEARITY (DNL)** is the measure of the maximum deviation from the ideal step size of 1 LSB, which is  $V_{REF} / 1024 = V_A / 1024$ .

**DIGITAL FEEDTHROUGH** is a measure of the energy injected into the analog output of the DAC from the digital inputs when the DAC outputs are not updated. It is measured with a full-scale code change on the data bus.

**FULL-SCALE ERROR** is the difference between the actual output voltage with a full scale code (3FFh) loaded into the DAC and the value of  $V_A \times 1023 / 1024$ .

**GAIN ERROR** is the deviation from the ideal slope of the transfer function. It can be calculated from Zero and Full-Scale Errors as  $GE = FSE - ZE$ , where GE is Gain error, FSE is Full-Scale Error and ZE is Zero Error.

**GLITCH IMPULSE** is the energy injected into the analog output when the input code to the DAC register changes. It is specified as the area of the glitch in nanovolt-seconds.

**INTEGRAL NON-LINEARITY (INL)** is a measure of the deviation of each individual code from a straight line through the input to output transfer function. The deviation of any given code from this straight line is measured from the center of that code value. The end point method is used. INL for this product is specified over a limited range, per the [Electrical Characteristics](#) Tables.

**LEAST SIGNIFICANT BIT (LSB)** is the bit that has the smallest value or weight of all bits in a word. This value is

$$LSB = V_{REF} / 2^n$$

where

- $V_{REF}$  is the supply voltage for this product
- "n" is the DAC resolution in bits, which is 10 for the DAC101S101 (6)

**MAXIMUM LOAD CAPACITANCE** is the maximum capacitance that can be driven by the DAC with output stability maintained.

**MONOTONICITY** is the condition of being monotonic, where the DAC has an output that never decreases when the output code increases.

**MOST SIGNIFICANT BIT (MSB)** is the bit that has the largest value or weight of all bits in a word. Its value is  $1/2$  of  $V_{REF}$ .

## Device Support (continued)

**POWER EFFICIENCY** is the ratio of the output current to the total supply current. The output current comes from the power supply. The difference between the supply and output currents, is the power consumed by the device without a load.

**SETTLING TIME** is the time for the output to settle within 1/2 LSB of the final value.

**WAKE-UP TIME** is the time for the output to settle within 1/2 LSB of the final value after the device is commanded to the active mode from any of the power down modes.

**ZERO CODE ERROR** is the output error, or voltage, present at the DAC output after a code of 000h has been entered.

## 12.2 Related Links

The table below lists quick access links. Categories include technical documents, support and community resources, tools and software, and quick access to sample or buy.

**Table 3. Related Links**

| PARTS         | PRODUCT FOLDER             | SAMPLE & BUY               | TECHNICAL DOCUMENTS        | TOOLS & SOFTWARE           | SUPPORT & COMMUNITY        |
|---------------|----------------------------|----------------------------|----------------------------|----------------------------|----------------------------|
| DAC101S101    | <a href="#">Click here</a> | <a href="#">Click here</a> | <a href="#">Click here</a> | <a href="#">Click here</a> | <a href="#">Click here</a> |
| DAC101S101-Q1 | <a href="#">Click here</a> | <a href="#">Click here</a> | <a href="#">Click here</a> | <a href="#">Click here</a> | <a href="#">Click here</a> |

## 12.3 Community Resources

The following links connect to TI community resources. Linked contents are provided "AS IS" by the respective contributors. They do not constitute TI specifications and do not necessarily reflect TI's views; see TI's [Terms of Use](#).

**TI E2E™ Online Community** *TI's Engineer-to-Engineer (E2E) Community*. Created to foster collaboration among engineers. At [e2e.ti.com](http://e2e.ti.com), you can ask questions, share knowledge, explore ideas and help solve problems with fellow engineers.

**Design Support** *TI's Design Support* Quickly find helpful E2E forums along with design support tools and contact information for technical support.

## 12.4 Trademarks

E2E is a trademark of Texas Instruments.  
All other trademarks are the property of their respective owners.

## 12.5 Electrostatic Discharge Caution



These devices have limited built-in ESD protection. The leads should be shorted together or the device placed in conductive foam during storage or handling to prevent electrostatic damage to the MOS gates.

## 12.6 Glossary

[SLYZ022](#) — *TI Glossary*.

This glossary lists and explains terms, acronyms, and definitions.

## 13 Mechanical, Packaging, and Orderable Information

The following pages include mechanical, packaging, and orderable information. This information is the most current data available for the designated devices. This data is subject to change without notice and revision of this document. For browser-based versions of this data sheet, refer to the left-hand navigation.

**PACKAGING INFORMATION**

| Orderable Device     | Status<br>(1) | Package Type | Package Drawing | Pins | Package Qty | Eco Plan<br>(2) | Lead finish/<br>Ball material<br>(6) | MSL Peak Temp<br>(3) | Op Temp (°C) | Device Marking<br>(4/5) | Samples                 |
|----------------------|---------------|--------------|-----------------|------|-------------|-----------------|--------------------------------------|----------------------|--------------|-------------------------|-------------------------|
| DAC101S101CIMK/NOPB  | ACTIVE        | SOT-23-THIN  | DDC             | 6    | 1000        | RoHS & Green    | SN                                   | Level-1-260C-UNLIM   | -40 to 105   | X63C                    | <a href="#">Samples</a> |
| DAC101S101CIMKX/NOPB | ACTIVE        | SOT-23-THIN  | DDC             | 6    | 3000        | RoHS & Green    | SN                                   | Level-1-260C-UNLIM   | -40 to 105   | X63C                    | <a href="#">Samples</a> |
| DAC101S101CIMM/NOPB  | ACTIVE        | VSSOP        | DGK             | 8    | 1000        | RoHS & Green    | SN                                   | Level-1-260C-UNLIM   | -40 to 105   | X62C                    | <a href="#">Samples</a> |
| DAC101S101QCMK/NOPB  | ACTIVE        | SOT-23-THIN  | DDC             | 6    | 1000        | RoHS & Green    | SN                                   | Level-1-260C-UNLIM   | -40 to 125   | X63Q                    | <a href="#">Samples</a> |
| DAC101S101QCMKX/NOPB | ACTIVE        | SOT-23-THIN  | DDC             | 6    | 3000        | RoHS & Green    | SN                                   | Level-1-260C-UNLIM   | -40 to 125   | X63Q                    | <a href="#">Samples</a> |

(1) The marketing status values are defined as follows:

**ACTIVE:** Product device recommended for new designs.

**LIFEBUY:** TI has announced that the device will be discontinued, and a lifetime-buy period is in effect.

**NRND:** Not recommended for new designs. Device is in production to support existing customers, but TI does not recommend using this part in a new design.

**PREVIEW:** Device has been announced but is not in production. Samples may or may not be available.

**OBSELETE:** TI has discontinued the production of the device.

(2) **RoHS:** TI defines "RoHS" to mean semiconductor products that are compliant with the current EU RoHS requirements for all 10 RoHS substances, including the requirement that RoHS substance do not exceed 0.1% by weight in homogeneous materials. Where designed to be soldered at high temperatures, "RoHS" products are suitable for use in specified lead-free processes. TI may reference these types of products as "Pb-Free".

**RoHS Exempt:** TI defines "RoHS Exempt" to mean products that contain lead but are compliant with EU RoHS pursuant to a specific EU RoHS exemption.

**Green:** TI defines "Green" to mean the content of Chlorine (Cl) and Bromine (Br) based flame retardants meet JS709B low halogen requirements of <=1000ppm threshold. Antimony trioxide based flame retardants must also meet the <=1000ppm threshold requirement.

(3) MSL, Peak Temp. - The Moisture Sensitivity Level rating according to the JEDEC industry standard classifications, and peak solder temperature.

(4) There may be additional marking, which relates to the logo, the lot trace code information, or the environmental category on the device.

(5) Multiple Device Markings will be inside parentheses. Only one Device Marking contained in parentheses and separated by a "~" will appear on a device. If a line is indented then it is a continuation of the previous line and the two combined represent the entire Device Marking for that device.

(6) Lead finish/Ball material - Orderable Devices may have multiple material finish options. Finish options are separated by a vertical ruled line. Lead finish/Ball material values may wrap to two lines if the finish value exceeds the maximum column width.

**Important Information and Disclaimer:**The information provided on this page represents TI's knowledge and belief as of the date that it is provided. TI bases its knowledge and belief on information provided by third parties, and makes no representation or warranty as to the accuracy of such information. Efforts are underway to better integrate information from third parties. TI has taken and continues to take reasonable steps to provide representative and accurate information but may not have conducted destructive testing or chemical analysis on incoming materials and chemicals. TI and TI suppliers consider certain information to be proprietary, and thus CAS numbers and other limited information may not be available for release.

In no event shall TI's liability arising out of such information exceed the total purchase price of the TI part(s) at issue in this document sold by TI to Customer on an annual basis.

**OTHER QUALIFIED VERSIONS OF DAC101S101, DAC101S101-Q1 :**

- Catalog: [DAC101S101](#)
- Automotive: [DAC101S101-Q1](#)

NOTE: Qualified Version Definitions:

- Catalog - TI's standard catalog product
- Automotive - Q100 devices qualified for high-reliability automotive applications targeting zero defects

**TAPE AND REEL INFORMATION**

**QUADRANT ASSIGNMENTS FOR PIN 1 ORIENTATION IN TAPE**


\*All dimensions are nominal

| Device               | Package Type | Package Drawing | Pins | SPQ  | Reel Diameter (mm) | Reel Width W1 (mm) | A0 (mm) | B0 (mm) | K0 (mm) | P1 (mm) | W (mm) | Pin1 Quadrant |
|----------------------|--------------|-----------------|------|------|--------------------|--------------------|---------|---------|---------|---------|--------|---------------|
| DAC101S101CIMK/NOPB  | SOT-23-THIN  | DDC             | 6    | 1000 | 178.0              | 8.4                | 3.2     | 3.2     | 1.4     | 4.0     | 8.0    | Q3            |
| DAC101S101CIMKX/NOPB | SOT-23-THIN  | DDC             | 6    | 3000 | 178.0              | 8.4                | 3.2     | 3.2     | 1.4     | 4.0     | 8.0    | Q3            |
| DAC101S101CIMM/NOPB  | VSSOP        | DGK             | 8    | 1000 | 178.0              | 12.4               | 5.3     | 3.4     | 1.4     | 8.0     | 12.0   | Q1            |
| DAC101S101QCMK/NOPB  | SOT-23-THIN  | DDC             | 6    | 1000 | 178.0              | 8.4                | 3.2     | 3.2     | 1.4     | 4.0     | 8.0    | Q3            |
| DAC101S101QCMKX/NOPB | SOT-23-THIN  | DDC             | 6    | 3000 | 178.0              | 8.4                | 3.2     | 3.2     | 1.4     | 4.0     | 8.0    | Q3            |

**TAPE AND REEL BOX DIMENSIONS**

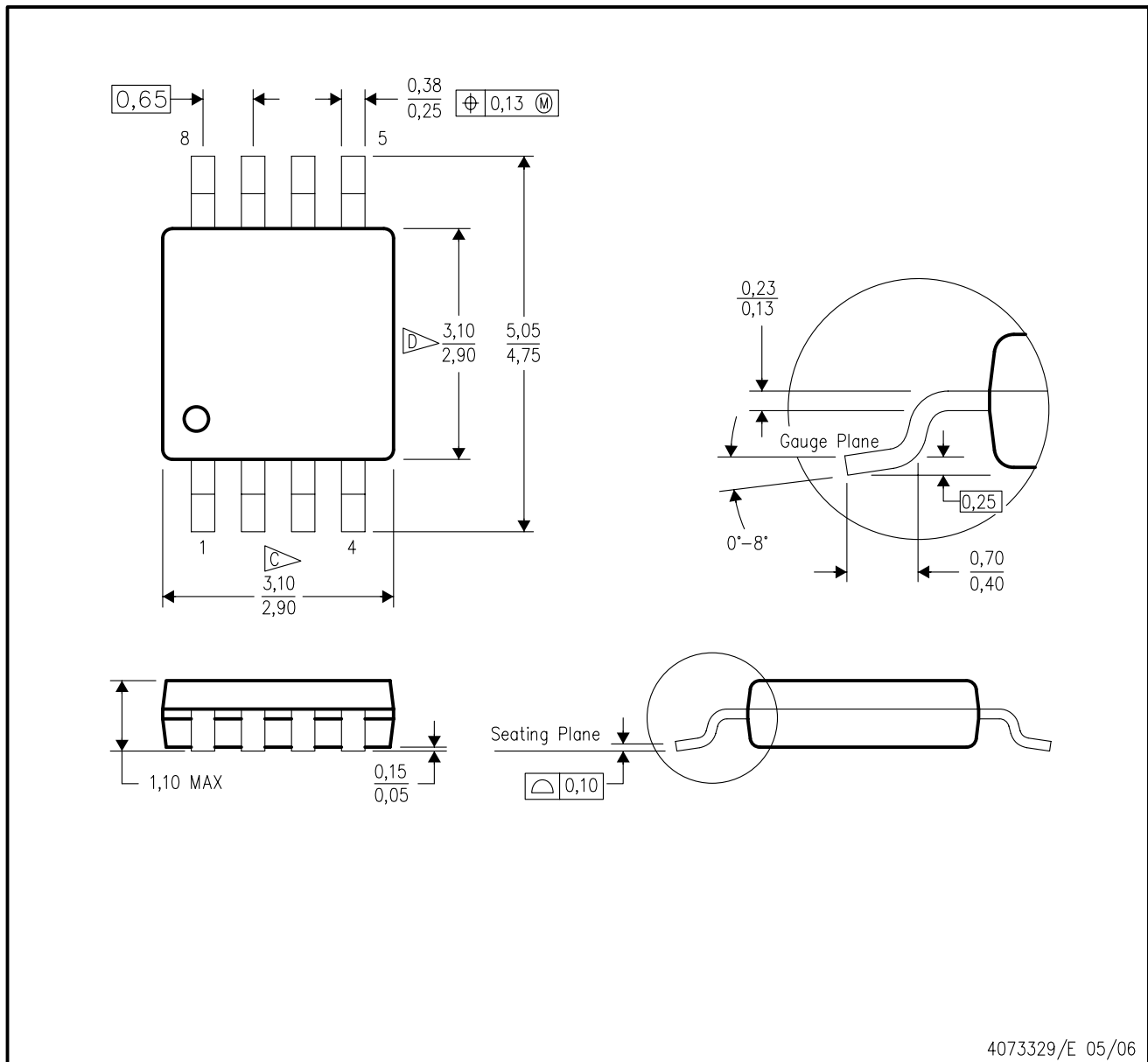

\*All dimensions are nominal

| Device                   | Package Type | Package Drawing | Pins | SPQ  | Length (mm) | Width (mm) | Height (mm) |
|--------------------------|--------------|-----------------|------|------|-------------|------------|-------------|
| DAC101S101CIMK/NOPB      | SOT-23-THIN  | DDC             | 6    | 1000 | 210.0       | 185.0      | 35.0        |
| DAC101S101CIMKX/<br>NOPB | SOT-23-THIN  | DDC             | 6    | 3000 | 210.0       | 185.0      | 35.0        |
| DAC101S101CIMM/NOPB      | VSSOP        | DGK             | 8    | 1000 | 210.0       | 185.0      | 35.0        |
| DAC101S101QCMK/NOPB      | SOT-23-THIN  | DDC             | 6    | 1000 | 210.0       | 185.0      | 35.0        |
| DAC101S101QCMKX/<br>NOPB | SOT-23-THIN  | DDC             | 6    | 3000 | 210.0       | 185.0      | 35.0        |



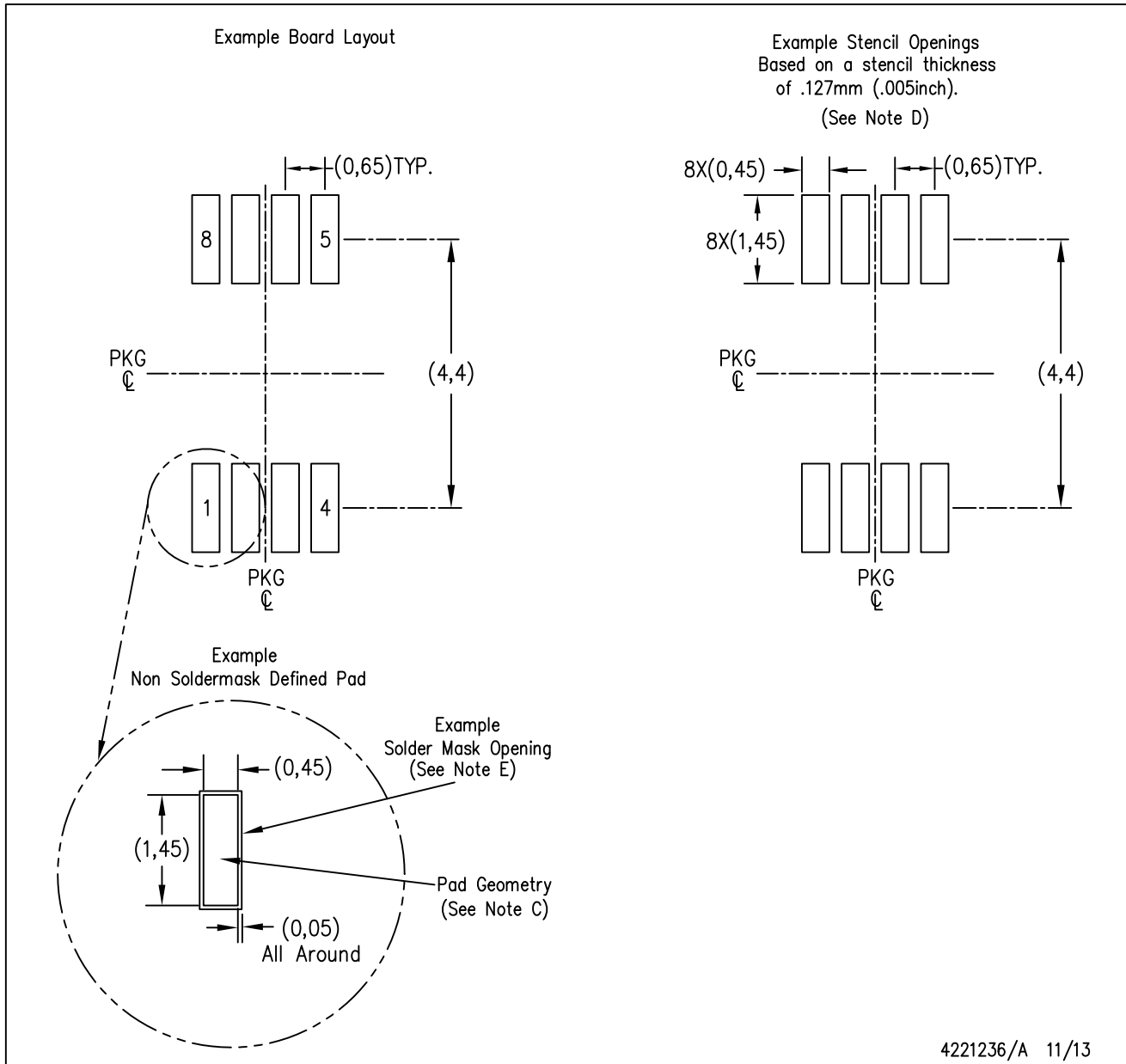
DGK (S-PDSO-G8)

PLASTIC SMALL-OUTLINE PACKAGE



4073329/E 05/06

- NOTES:
- A. All linear dimensions are in millimeters.
  - B. This drawing is subject to change without notice.
  - C. Body length does not include mold flash, protrusions, or gate burrs. Mold flash, protrusions, or gate burrs shall not exceed 0.15 per end.
  - D. Body width does not include interlead flash. Interlead flash shall not exceed 0.50 per side.
  - E. Falls within JEDEC MO-187 variation AA, except interlead flash.



- NOTES:
- A. All linear dimensions are in millimeters.
  - B. This drawing is subject to change without notice.
  - C. Publication IPC-7351 is recommended for alternate designs.
  - D. Laser cutting apertures with trapezoidal walls and also rounding corners will offer better paste release. Customers should contact their board assembly site for stencil design recommendations. Refer to IPC-7525 for other stencil recommendations.
  - E. Customers should contact their board fabrication site for solder mask tolerances between and around signal pads.

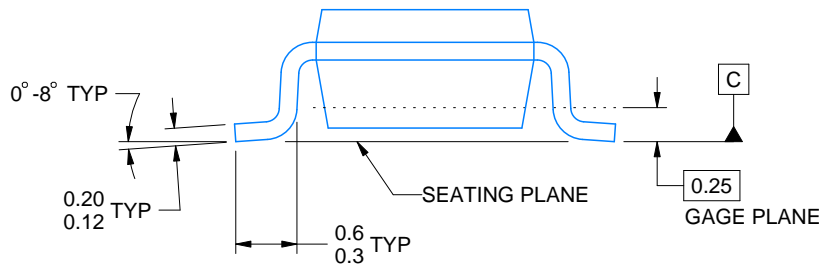
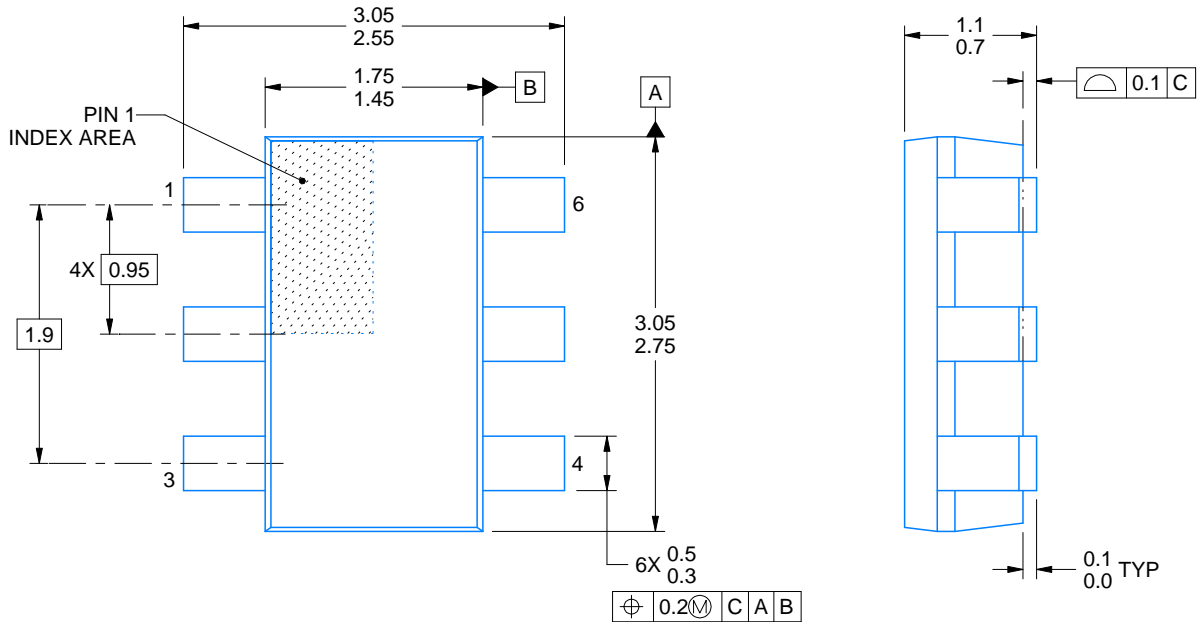
DDC0006A



# PACKAGE OUTLINE

SOT-23 - 1.1 max height

SMALL OUTLINE TRANSISTOR



4214841/C 04/2022

NOTES:

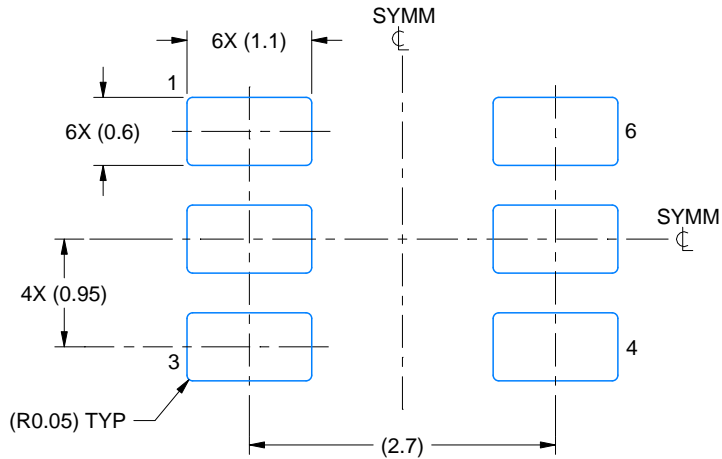
1. All linear dimensions are in millimeters. Any dimensions in parenthesis are for reference only. Dimensioning and tolerancing per ASME Y14.5M.
2. This drawing is subject to change without notice.
3. Reference JEDEC MO-193.

# EXAMPLE BOARD LAYOUT

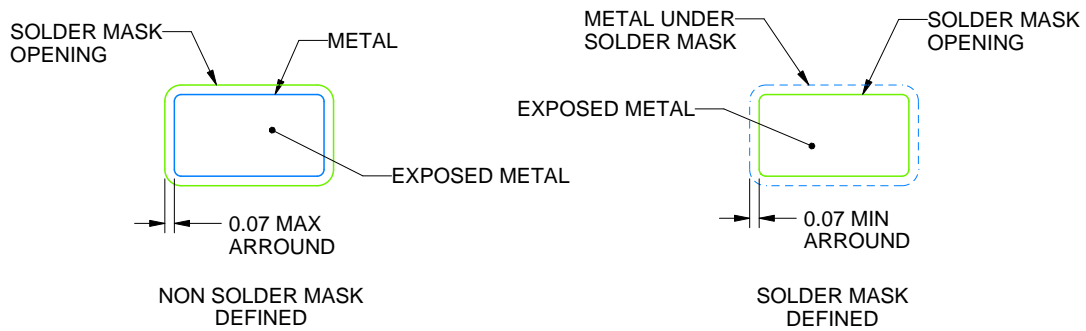
DDC0006A

SOT-23 - 1.1 max height

SMALL OUTLINE TRANSISTOR



LAND PATTERN EXAMPLE  
EXPLODED METAL SHOWN  
SCALE:15X



SOLDEMASK DETAILS

4214841/C 04/2022

NOTES: (continued)

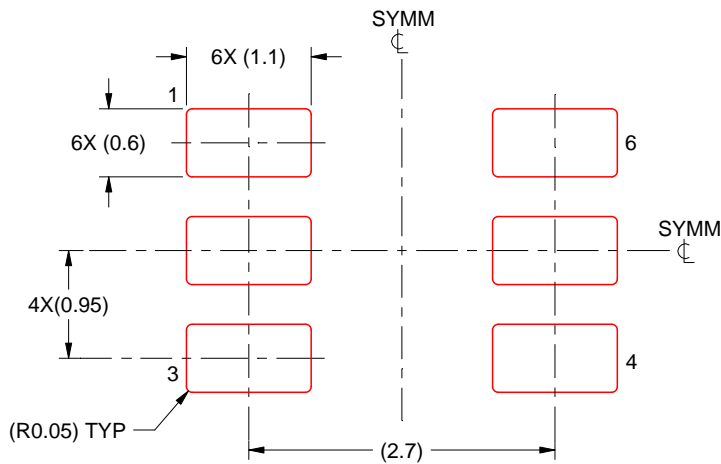
- 4. Publication IPC-7351 may have alternate designs.
- 5. Solder mask tolerances between and around signal pads can vary based on board fabrication site.

# EXAMPLE STENCIL DESIGN

DDC0006A

SOT-23 - 1.1 max height

SMALL OUTLINE TRANSISTOR



SOLDER PASTE EXAMPLE  
BASED ON 0.125 THICK STENCIL  
SCALE:15X

4214841/C 04/2022

NOTES: (continued)

6. Laser cutting apertures with trapezoidal walls and rounded corners may offer better paste release. IPC-7525 may have alternate design recommendations.
7. Board assembly site may have different recommendations for stencil design.

## IMPORTANT NOTICE AND DISCLAIMER

TI PROVIDES TECHNICAL AND RELIABILITY DATA (INCLUDING DATA SHEETS), DESIGN RESOURCES (INCLUDING REFERENCE DESIGNS), APPLICATION OR OTHER DESIGN ADVICE, WEB TOOLS, SAFETY INFORMATION, AND OTHER RESOURCES "AS IS" AND WITH ALL FAULTS, AND DISCLAIMS ALL WARRANTIES, EXPRESS AND IMPLIED, INCLUDING WITHOUT LIMITATION ANY IMPLIED WARRANTIES OF MERCHANTABILITY, FITNESS FOR A PARTICULAR PURPOSE OR NON-INFRINGEMENT OF THIRD PARTY INTELLECTUAL PROPERTY RIGHTS.

These resources are intended for skilled developers designing with TI products. You are solely responsible for (1) selecting the appropriate TI products for your application, (2) designing, validating and testing your application, and (3) ensuring your application meets applicable standards, and any other safety, security, regulatory or other requirements.

These resources are subject to change without notice. TI grants you permission to use these resources only for development of an application that uses the TI products described in the resource. Other reproduction and display of these resources is prohibited. No license is granted to any other TI intellectual property right or to any third party intellectual property right. TI disclaims responsibility for, and you will fully indemnify TI and its representatives against, any claims, damages, costs, losses, and liabilities arising out of your use of these resources.

TI's products are provided subject to [TI's Terms of Sale](#) or other applicable terms available either on [ti.com](http://ti.com) or provided in conjunction with such TI products. TI's provision of these resources does not expand or otherwise alter TI's applicable warranties or warranty disclaimers for TI products.

TI objects to and rejects any additional or different terms you may have proposed.

Mailing Address: Texas Instruments, Post Office Box 655303, Dallas, Texas 75265  
Copyright © 2022, Texas Instruments Incorporated