

# TLV2361, TLV2362

## HIGH-PERFORMANCE LOW-VOLTAGE OPERATIONAL AMPLIFIERS

SLOS195H – FEBRUARY 1997 – REVISED JUNE 2007

- **Low Supply-Voltage Operation . . .  $V_{CC} = \pm 1$  V Min**
- **Wide Bandwidth . . . 7 MHz Typ at  $V_{CC\pm} = \pm 2.5$  V**
- **High Slew Rate . . . 3 V/ $\mu$ s Typ at  $V_{CC\pm} = \pm 2.5$  V**
- **Wide Output Voltage Swing . . .  $\pm 2.4$  V Typ at  $V_{CC\pm} = \pm 2.5$  V,  $R_L = 10$  k $\Omega$**
- **Low Noise . . . 8 nV/ $\sqrt{\text{Hz}}$  Typ at  $f = 1$  kHz**

### description/ordering information

The TLV236x devices are high-performance dual operational amplifiers built using an original Texas Instruments bipolar process. These devices can be operated at a very low supply voltage ( $\pm 1$  V), while maintaining a wide output swing. The TLV236x devices offer a dramatically improved dynamic range of signal conditioning in low-voltage systems. The TLV236x devices also provide higher performance than other general-purpose operational amplifiers by combining higher unity-gain bandwidth and faster slew rate. With their low distortion and low-noise performance, these devices are well suited for audio applications.

**TLV2361 . . . DBV PACKAGE (TOP VIEW)**

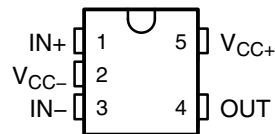

**TLV2362 . . . D, DGK, P, PS, OR PW PACKAGE (TOP VIEW)**

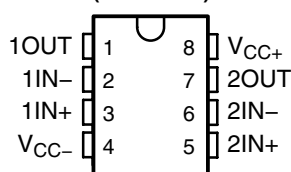

### ORDERING INFORMATION

$T_A$	PACKAGE <sup>†</sup>		ORDERABLE PART NUMBER	TOP-SIDE MARKING <sup>‡</sup>
-0°C to 70°C	SOT-23-5 (DBV)	Reel of 3000	TLV2361CDBVR	YC3_
		Reel of 250	TLV2361CDBVT	
-40°C to 85°C	SOT-23-5 (DBV)	Reel of 3000	TLV2361IDBVR	YC4_
		Reel of 250	TLV2361IDBVT	
	MSOP/VSSOP (DGK)	Reel of 2500	TLV2362IDGKR	YBS
	PDIP (P)	Tube of 50	TLV2362IP	TLV2362IP
	SOIC (D)	Tube of 75	TLV2362ID	2362I
		Reel of 2500	TLV2362IDR	
	SOP (PS)	Reel of 2000	TLV2362IPSR	TY2362
	TSSOP (PW)	Tube of 150	TLV2362IPW	TY2362
Reel of 2000		TLV2362IPWR		

<sup>†</sup> Package drawings, standard packing quantities, thermal data, symbolization, and PCB design guidelines are available at [www.ti.com/sc/package](http://www.ti.com/sc/package).

<sup>‡</sup> DBV: The actual top-side marking has one additional character that designates the wafer fab/assembly site.



Please be aware that an important notice concerning availability, standard warranty, and use in critical applications of Texas Instruments semiconductor products and disclaimers thereto appears at the end of this data sheet.

**PRODUCTION DATA** information is current as of publication date. Products conform to specifications per the terms of Texas Instruments standard warranty. Production processing does not necessarily include testing of all parameters.



POST OFFICE BOX 655303 • DALLAS, TEXAS 75265  
POST OFFICE BOX 1443 • HOUSTON, TEXAS 77251-1443

Copyright © 2007, Texas Instruments Incorporated

# TLV2361, TLV2362 HIGH-PERFORMANCE LOW-VOLTAGE OPERATIONAL AMPLIFIERS

SLOS195H – FEBRUARY 1997 – REVISED JUNE 2007

equivalent schematic (each amplifier)

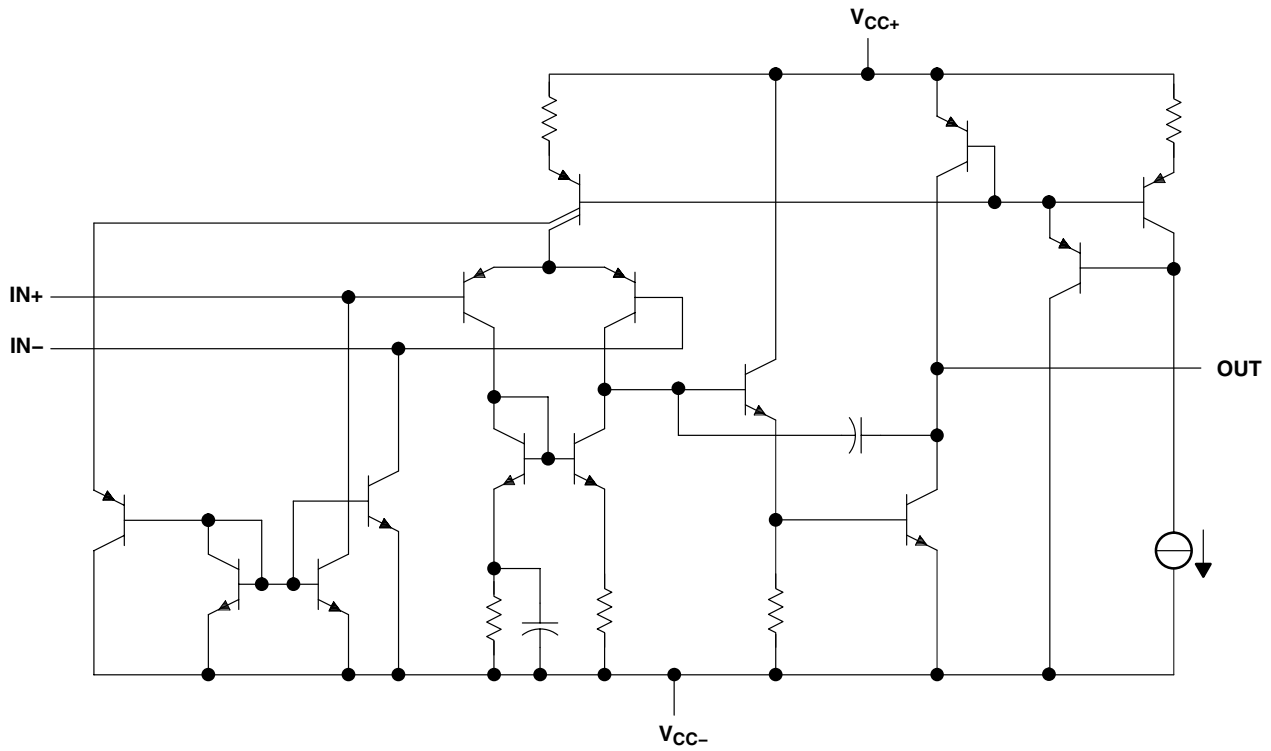

ACTUAL DEVICE COMPONENT COUNT		
COMPONENT	TLV2361	TLV2362
Transistors	30	46
Resistors	6	11
Diodes	1	1
Capacitors	2	4
JFET	1	1

# TLV2361, TLV2362

## HIGH-PERFORMANCE LOW-VOLTAGE OPERATIONAL AMPLIFIERS

SLOS195H – FEBRUARY 1997 – REVISED JUNE 2007

### absolute maximum ratings over operating free-air temperature range (unless otherwise noted)†

Supply voltage, $V_{CC+}$ (see Note 1)	3.5 V	
Supply voltage, $V_{CC-}$ (see Note 1)	–3.5 V	
Differential input voltage, $V_{ID}$ (see Note 2)	$\pm 3.5$ V	
Input voltage, $V_I$ (any input) (see Notes 1 and 3)	$V_{CC\pm}$	
Output voltage, $V_O$	$\pm 3.5$ V	
Output current, $I_O$	20 mA	
Duration of short-circuit current at (or below) 25°C (output shorted to GND)	Unlimited	
Package thermal impedance, $\theta_{JA}$ (see Notes 4 and 5):	D package	97°C/W
	DBV package	206°C/W
	DGK package	172°C/W
	P package	85°C/W
	PS package	95°C/W
	PW package	149°C/W
Operating virtual junction temperature, $T_J$	150°C	
Lead temperature 1,6 mm (1/16 inch) from case for 10 seconds	260°C	
Storage temperature range, $T_{stg}$	–65°C to 150°C	

† Stresses beyond those listed under “absolute maximum ratings” may cause permanent damage to the device. These are stress ratings only, and functional operation of the device at these or any other conditions beyond those indicated under “recommended operating conditions” is not implied. Exposure to absolute-maximum-rated conditions for extended periods may affect device reliability.

- NOTES:
1. All voltage values, except differential voltages, are with respect to the midpoint between  $V_{CC+}$  and  $V_{CC-}$ .
  2. Differential voltages are at  $IN+$  with respect to  $IN-$ .
  3. All input voltage values must not exceed  $V_{CC}$ .
  4. Maximum power dissipation is a function of  $T_J(\max)$ ,  $\theta_{JA}$ , and  $T_A$ . The maximum allowable power dissipation at any allowable ambient temperature is  $P_D = (T_J(\max) - T_A)/\theta_{JA}$ . Selecting the maximum of 150°C can affect reliability.
  5. The package thermal impedance is calculated in accordance with JESD 51-7.

### recommended operating conditions

		MIN	MAX	UNIT
$V_{CC}$	Supply voltage	$\pm 1$	$\pm 2.5$	V
$T_A$	Operating free-air temperature	TLV2361C	0	70
		TLV2361I, TLV2362I	–40	85



# TLV2361, TLV2362 HIGH-PERFORMANCE LOW-VOLTAGE OPERATIONAL AMPLIFIERS

SLOS195H – FEBRUARY 1997 – REVISED JUNE 2007

## TLV2361 and TLV2362 electrical characteristics, $V_{CC\pm} = \pm 1.5\text{ V}$ (unless otherwise noted)

PARAMETER		TEST CONDITIONS		$T_A$	MIN	TYP	MAX	UNIT
$V_{IO}$	Input offset voltage	$V_O = 0,$	$V_{IC} = 0$	25°C	1	6		mV
				Full range		7.5		
$I_{IO}$	Input offset current	$V_O = 0,$	$V_{IC} = 0$	25°C	5	100		nA
				Full range		150		
$I_{IB}$	Input bias current	$V_O = 0,$	$V_{IC} = 0$	25°C	20	150		nA
				Full range		250		
$V_{IC}$	Common-mode input voltage	$ V_{IO}  \leq 7.5\text{ mV}$		25°C	$\pm 0.5$			V
				Full range	$\pm 0.5$			
$V_{OM+}$	Maximum positive-peak output voltage	$R_L = 10\text{ k}\Omega$		25°C	1.2	1.4		V
		$R_L \geq 10\text{ k}\Omega$		Full range	1.2			
$V_{OM-}$	Maximum negative-peak output voltage	$R_L = 10\text{ k}\Omega$		25°C	-1.2	-1.4		V
		$R_L \geq 10\text{ k}\Omega$		Full range	-1.2			
$I_{CC}$	Supply current (per amplifier)	$V_O = 0,$	No load	25°C	1.4	2.25		mA
				Full range		2.75		mA
$A_{VD}$	Large-signal differential voltage amplification	$V_O = \pm 1\text{ V},$	$R_L = 10\text{ k}\Omega$	TLV2361	25°C	60	80	dB
				TLV2362		55		
CMRR	Common-mode rejection ratio	$V_{IC} = \pm 0.5\text{ V}$		25°C	75		dB	
$k_{SVR}$	Supply-voltage rejection ratio	$V_{CC\pm} = \pm 1.5\text{ V to } \pm 2.5\text{ V}$		25°C	80		dB	

## TLV2361 and TLV2362 operating characteristics, $V_{CC\pm} = \pm 1.5\text{ V}, T_A = 25^\circ\text{C}$

PARAMETER		TEST CONDITIONS				TYP	UNIT
SR	Slew rate	$A_V = 1,$	$V_I = \pm 0.5\text{ V}$			2.5	V/ $\mu\text{s}$
$B_1$	Unity-gain bandwidth	$A_V = 40,$	$R_L = 10\text{ k}\Omega,$	$C_L = 100\text{ pF}$		6	MHz
$V_n$	Equivalent input noise voltage	$R_S = 100\ \Omega,$	$R_F = 10\text{ k}\Omega,$	$f = 1\text{ kHz}$		9	nV/ $\sqrt{\text{Hz}}$



# TLV2361, TLV2362

## HIGH-PERFORMANCE LOW-VOLTAGE OPERATIONAL AMPLIFIERS

SLOS195H – FEBRUARY 1997 – REVISED JUNE 2007

### TLV2361 and TLV2362 electrical characteristics, $V_{CC\pm} = \pm 2.5$ V (unless otherwise noted)

PARAMETER		TEST CONDITIONS		$T_A$	MIN	TYP	MAX	UNIT
$V_{IO}$	Input offset voltage	$V_O = 0,$	$V_{IC} = 0$	25°C	1	6		mV
				Full range			7.5	
$I_{IO}$	Input offset current	$V_O = 0,$	$V_{IC} = 0$	25°C	5	100		nA
				Full range			150	
$I_{IB}$	Input bias current	$V_O = 0,$	$V_{IC} = 0$	25°C	20	150		nA
				Full range			250	
$V_{IC}$	Common-mode input voltage	$ V_{IO}  \leq 7.5$ mV		25°C	$\pm 1.5$			V
				Full range	$\pm 1.4$			
$V_{OM+}$	Maximum positive-peak output voltage	$R_L = 10$ k $\Omega$		25°C	2	2.4		V
		$R_L \geq 10$ k $\Omega$		Full range	2			
$V_{OM-}$	Maximum negative-peak output voltage	$R_L = 10$ k $\Omega$		25°C	-2	-2.4		V
		$R_L \geq 10$ k $\Omega$		Full range	-2			
$I_{CC}$	Supply current (per amplifier)	$V_O = 0,$	No load	25°C	1.75	2.5		mA
				Full range		3		
$A_{VD}$	Large-signal differential voltage amplification	$V_O = \pm 1$ V,	$R_L = 10$ k $\Omega$	TLV2361	25°C	60	80	dB
				TLV2362		60		
CMRR	Common-mode rejection ratio	$V_{IC} = \pm 0.5$ V		25°C	85		dB	
$k_{SVR}$	Supply-voltage rejection ratio	$V_{CC\pm} = \pm 1.5$ V to $\pm 2.5$ V		25°C	80		dB	

### TLV2361 and TLV2362 operating characteristics, $V_{CC\pm} = \pm 2.5$ V, $T_A = 25^\circ\text{C}$

PARAMETER		TEST CONDITIONS		TYP	UNIT
SR	Slew rate	$A_V = 1,$	$V_I = \pm 0.5$ V	3	V/ $\mu$ s
$B_1$	Unity-gain bandwidth	$A_V = 40,$	$R_L = 10$ k $\Omega,$ $C_L = 100$ pF	7	MHz
$V_n$	Equivalent input noise voltage	$R_S = 100$ $\Omega,$	$R_F = 10$ k $\Omega,$ $f = 1$ kHz	8	nV/ $\sqrt{\text{Hz}}$
THD + N	Total harmonic distortion, plus noise	$A_V = 1,$	$V_O = \pm 1.2$ V, $R_L = 10$ k $\Omega,$ $f = 3$ kHz	0.004	%



# TLV2361, TLV2362 HIGH-PERFORMANCE LOW-VOLTAGE OPERATIONAL AMPLIFIERS

SLOS195H – FEBRUARY 1997 – REVISED JUNE 2007

---

## TYPICAL CHARACTERISTICS

Table of Graphs

GRAPH TITLE	FIGURE
Supply current vs Free-air temperature	1
Supply current vs Supply voltage	2
Maximum positive output voltage vs Output current	3
Maximum negative output voltage vs Output current	4
Maximum peak-to-peak output voltage vs Frequency	5
Equivalent input noise voltage vs Frequency	6
Total harmonic distortion vs Frequency	7
Total harmonic distortion vs Output voltage	8



POST OFFICE BOX 655303 • DALLAS, TEXAS 75265  
POST OFFICE BOX 1443 • HOUSTON, TEXAS 77251-1443

**TYPICAL CHARACTERISTICS**

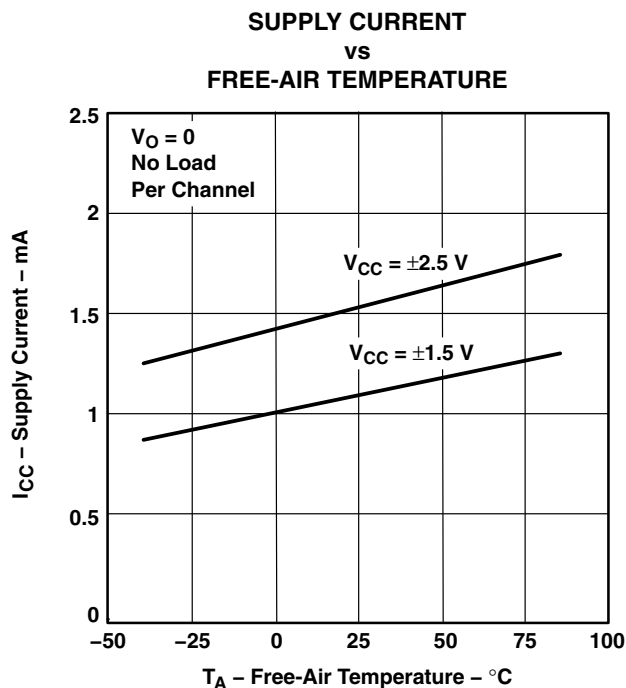

**Figure 1**

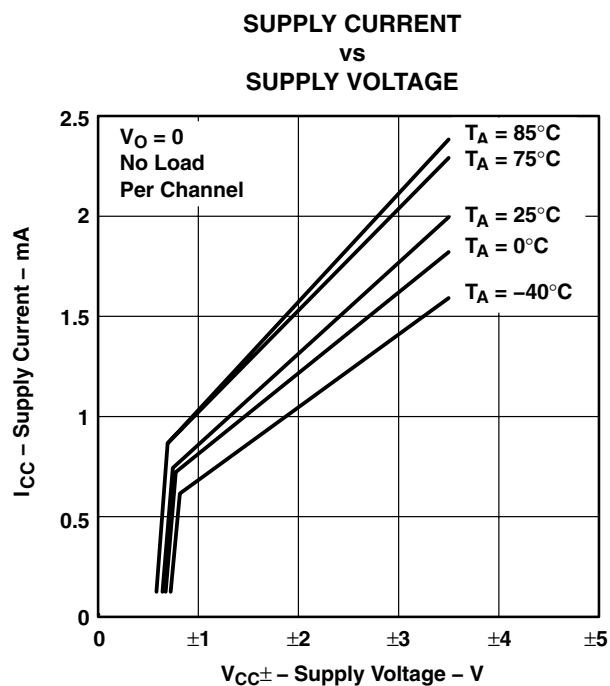

**Figure 2**

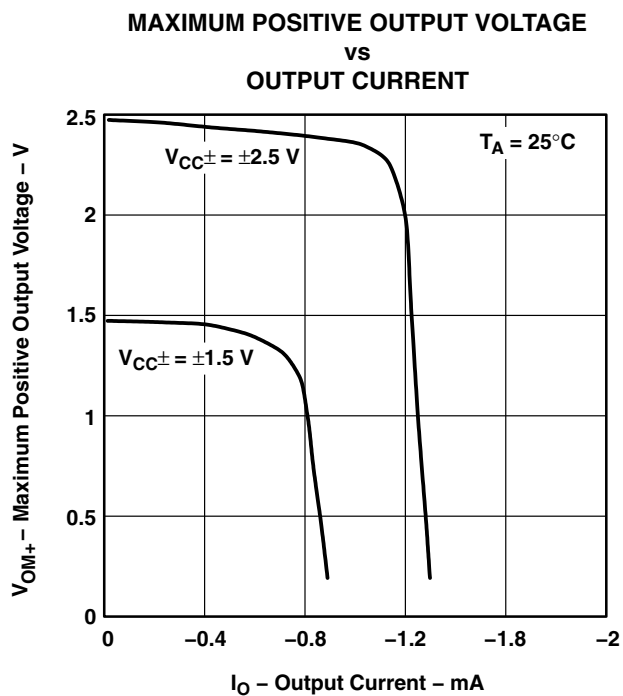

**Figure 3**

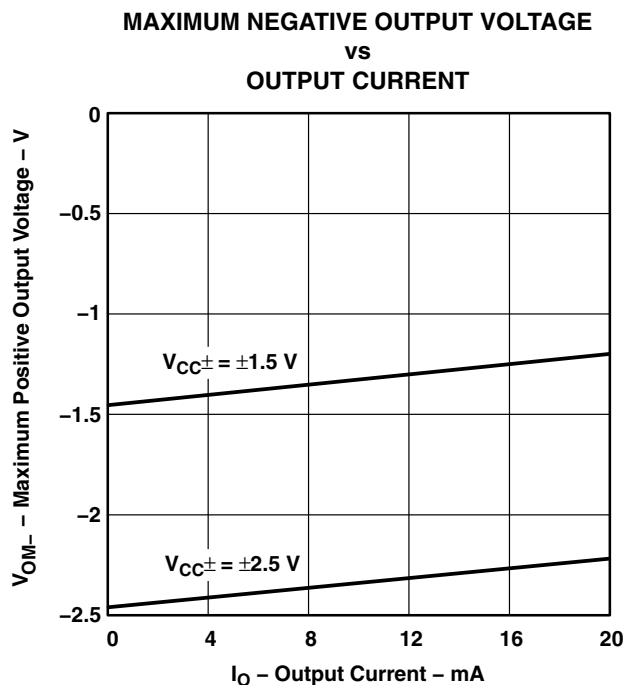

**Figure 4**

# TLV2361, TLV2362 HIGH-PERFORMANCE LOW-VOLTAGE OPERATIONAL AMPLIFIERS

SLOS195H – FEBRUARY 1997 – REVISED JUNE 2007

## TYPICAL CHARACTERISTICS

MAXIMUM PEAK-TO-PEAK OUTPUT VOLTAGE  
vs  
FREQUENCY

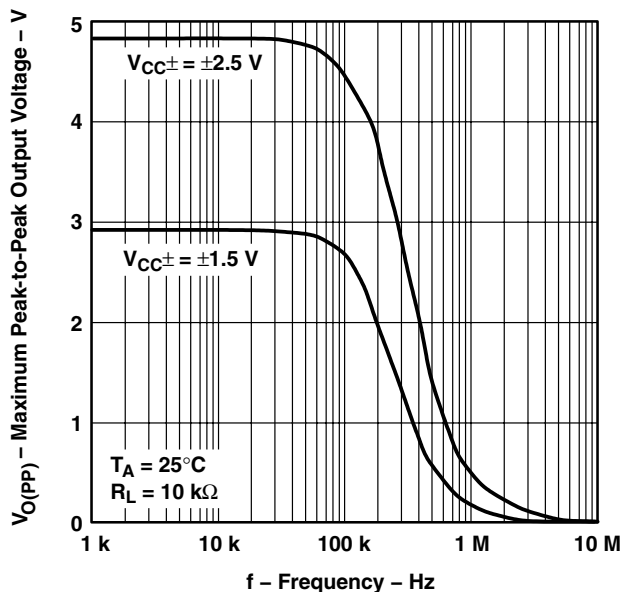

Figure 5

EQUIVALENT INPUT NOISE VOLTAGE  
vs  
FREQUENCY

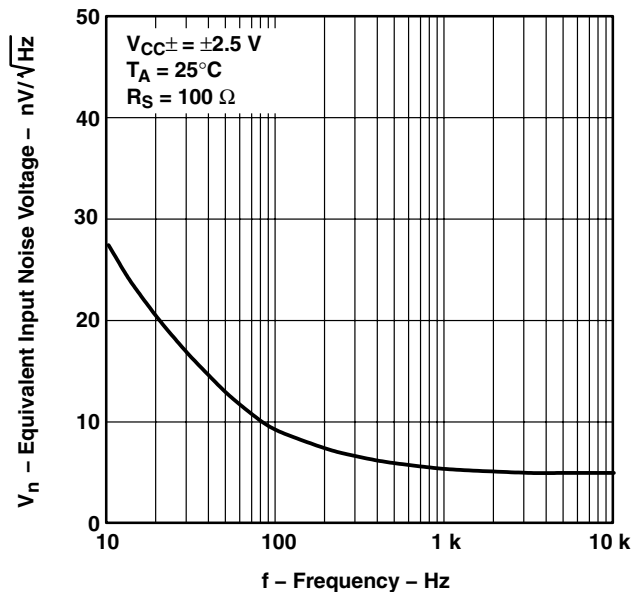

Figure 6

TOTAL HARMONIC DISTORTION  
vs  
FREQUENCY

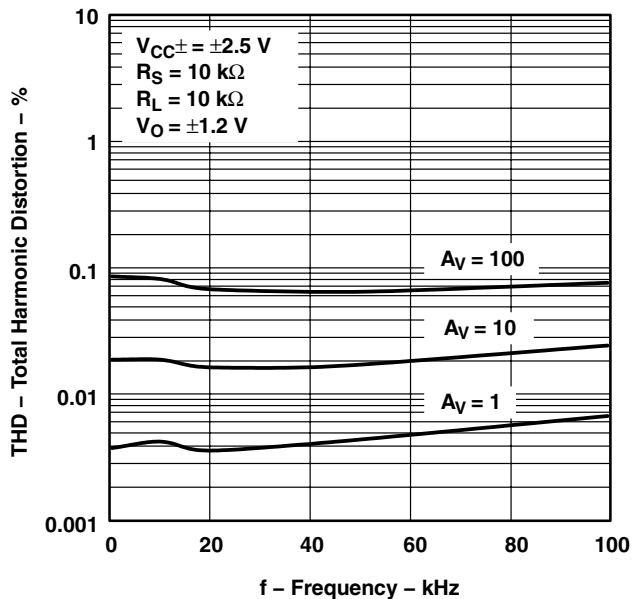

Figure 7

TOTAL HARMONIC DISTORTION  
vs  
OUTPUT VOLTAGE

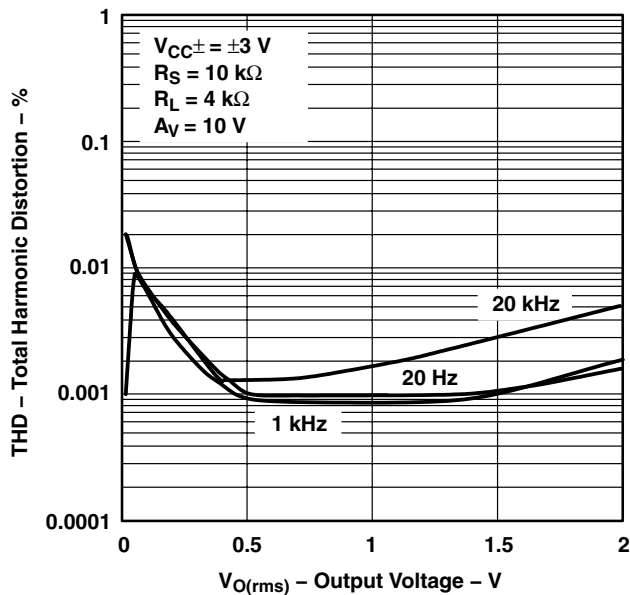

Figure 8





**PACKAGING INFORMATION**

Orderable Device	Status (1)	Package Type	Package Drawing	Pins	Package Qty	Eco Plan (2)	Lead finish/ Ball material (6)	MSL Peak Temp (3)	Op Temp (°C)	Device Marking (4/5)	Samples
TLV2361CDBVR	ACTIVE	SOT-23	DBV	5	3000	RoHS & Green	NIPDAU   SN	Level-1-260C-UNLIM	0 to 70	(YC3B, YC3G, YC3J, YC3L)	<a href="#">Samples</a>
TLV2361CDBVT	ACTIVE	SOT-23	DBV	5	250	RoHS & Green	NIPDAU   SN	Level-1-260C-UNLIM	0 to 70	(YC3B, YC3G, YC3J, YC3L)	<a href="#">Samples</a>
TLV2361IDBVR	ACTIVE	SOT-23	DBV	5	3000	RoHS & Green	NIPDAU   SN	Level-1-260C-UNLIM	-40 to 85	(YC4B, YC4G, YC4J, YC4L)	<a href="#">Samples</a>
TLV2361IDBVT	LIFEBUY	SOT-23	DBV	5	250	RoHS & Green	NIPDAU   SN	Level-1-260C-UNLIM	-40 to 85	(YC4B, YC4G, YC4J, YC4L)	
TLV2362ID	ACTIVE	SOIC	D	8	75	RoHS & Green	NIPDAU	Level-1-260C-UNLIM	-40 to 85	2362I	<a href="#">Samples</a>
TLV2362IDGKR	ACTIVE	VSSOP	DGK	8	2500	RoHS & Green	NIPDAU	Level-1-260C-UNLIM	-40 to 85	(YBL, YBS, YBU)	<a href="#">Samples</a>
TLV2362IDR	ACTIVE	SOIC	D	8	2500	RoHS & Green	NIPDAU	Level-1-260C-UNLIM	-40 to 85	2362I	<a href="#">Samples</a>
TLV2362IP	ACTIVE	PDIP	P	8	50	RoHS & Green	NIPDAU	N / A for Pkg Type	-40 to 85	TLV2362IP	<a href="#">Samples</a>
TLV2362IPWR	ACTIVE	TSSOP	PW	8	2000	RoHS & Green	NIPDAU	Level-1-260C-UNLIM	-40 to 85	TY2362	<a href="#">Samples</a>

(1) The marketing status values are defined as follows:

**ACTIVE:** Product device recommended for new designs.

**LIFEBUY:** TI has announced that the device will be discontinued, and a lifetime-buy period is in effect.

**NRND:** Not recommended for new designs. Device is in production to support existing customers, but TI does not recommend using this part in a new design.

**PREVIEW:** Device has been announced but is not in production. Samples may or may not be available.

**OBSOLETE:** TI has discontinued the production of the device.

(2) **RoHS:** TI defines "RoHS" to mean semiconductor products that are compliant with the current EU RoHS requirements for all 10 RoHS substances, including the requirement that RoHS substance do not exceed 0.1% by weight in homogeneous materials. Where designed to be soldered at high temperatures, "RoHS" products are suitable for use in specified lead-free processes. TI may reference these types of products as "Pb-Free".

**RoHS Exempt:** TI defines "RoHS Exempt" to mean products that contain lead but are compliant with EU RoHS pursuant to a specific EU RoHS exemption.

**Green:** TI defines "Green" to mean the content of Chlorine (Cl) and Bromine (Br) based flame retardants meet JS709B low halogen requirements of <=1000ppm threshold. Antimony trioxide based flame retardants must also meet the <=1000ppm threshold requirement.

(3) MSL, Peak Temp. - The Moisture Sensitivity Level rating according to the JEDEC industry standard classifications, and peak solder temperature.

(4) There may be additional marking, which relates to the logo, the lot trace code information, or the environmental category on the device.

<sup>(5)</sup> Multiple Device Markings will be inside parentheses. Only one Device Marking contained in parentheses and separated by a "~" will appear on a device. If a line is indented then it is a continuation of the previous line and the two combined represent the entire Device Marking for that device.

<sup>(6)</sup> Lead finish/Ball material - Orderable Devices may have multiple material finish options. Finish options are separated by a vertical ruled line. Lead finish/Ball material values may wrap to two lines if the finish value exceeds the maximum column width.

**Important Information and Disclaimer:**The information provided on this page represents TI's knowledge and belief as of the date that it is provided. TI bases its knowledge and belief on information provided by third parties, and makes no representation or warranty as to the accuracy of such information. Efforts are underway to better integrate information from third parties. TI has taken and continues to take reasonable steps to provide representative and accurate information but may not have conducted destructive testing or chemical analysis on incoming materials and chemicals. TI and TI suppliers consider certain information to be proprietary, and thus CAS numbers and other limited information may not be available for release.

In no event shall TI's liability arising out of such information exceed the total purchase price of the TI part(s) at issue in this document sold by TI to Customer on an annual basis.

**TAPE AND REEL INFORMATION**

**QUADRANT ASSIGNMENTS FOR PIN 1 ORIENTATION IN TAPE**

\*All dimensions are nominal

Device	Package Type	Package Drawing	Pins	SPQ	Reel Diameter (mm)	Reel Width W1 (mm)	A0 (mm)	B0 (mm)	K0 (mm)	P1 (mm)	W (mm)	Pin1 Quadrant
TLV2361CDBVR	SOT-23	DBV	5	3000	178.0	9.0	3.3	3.2	1.4	4.0	8.0	Q3
TLV2361CDBVT	SOT-23	DBV	5	250	178.0	9.0	3.3	3.2	1.4	4.0	8.0	Q3
TLV2361IDBVR	SOT-23	DBV	5	3000	178.0	9.0	3.3	3.2	1.4	4.0	8.0	Q3
TLV2361IDBVT	SOT-23	DBV	5	250	178.0	9.0	3.3	3.2	1.4	4.0	8.0	Q3
TLV2362IDGKR	VSSOP	DGK	8	2500	330.0	12.4	5.3	3.3	1.3	8.0	12.0	Q1
TLV2362IDR	SOIC	D	8	2500	330.0	12.4	6.4	5.2	2.1	8.0	12.0	Q1
TLV2362IPWR	TSSOP	PW	8	2000	330.0	12.4	7.0	3.6	1.6	8.0	12.0	Q1

**TAPE AND REEL BOX DIMENSIONS**

\*All dimensions are nominal

Device	Package Type	Package Drawing	Pins	SPQ	Length (mm)	Width (mm)	Height (mm)
TLV2361CDBVR	SOT-23	DBV	5	3000	180.0	180.0	18.0
TLV2361CDBVT	SOT-23	DBV	5	250	180.0	180.0	18.0
TLV2361IDBVR	SOT-23	DBV	5	3000	180.0	180.0	18.0
TLV2361IDBVT	SOT-23	DBV	5	250	180.0	180.0	18.0
TLV2362IDGKR	VSSOP	DGK	8	2500	346.0	346.0	35.0
TLV2362IDR	SOIC	D	8	2500	340.5	338.1	20.6
TLV2362IPWR	TSSOP	PW	8	2000	356.0	356.0	35.0

**TUBE**

\*All dimensions are nominal

Device	Package Name	Package Type	Pins	SPQ	L (mm)	W (mm)	T (μm)	B (mm)
TLV2362ID	D	SOIC	8	75	507	8	3940	4.32
TLV2362IP	P	PDIP	8	50	506	13.97	11230	4.32

# DBV0005A



# PACKAGE OUTLINE

SOT-23 - 1.45 mm max height

SMALL OUTLINE TRANSISTOR



## NOTES:

1. All linear dimensions are in millimeters. Any dimensions in parenthesis are for reference only. Dimensioning and tolerancing per ASME Y14.5M.
2. This drawing is subject to change without notice.
3. Reference JEDEC MO-178.
4. Body dimensions do not include mold flash, protrusions, or gate burrs. Mold flash, protrusions, or gate burrs shall not exceed 0.25 mm per side.
5. Support pin may differ or may not be present.

# EXAMPLE BOARD LAYOUT

DBV0005A

SOT-23 - 1.45 mm max height

SMALL OUTLINE TRANSISTOR



LAND PATTERN EXAMPLE  
EXPOSED METAL SHOWN  
SCALE:15X

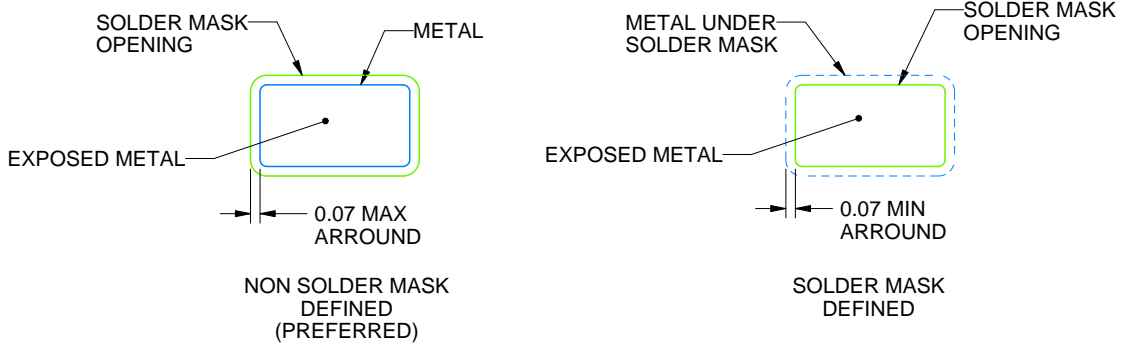

SOLDER MASK DETAILS

4214839/H 09/2023

NOTES: (continued)

- 6. Publication IPC-7351 may have alternate designs.
- 7. Solder mask tolerances between and around signal pads can vary based on board fabrication site.

# EXAMPLE STENCIL DESIGN

DBV0005A

SOT-23 - 1.45 mm max height

SMALL OUTLINE TRANSISTOR



SOLDER PASTE EXAMPLE  
BASED ON 0.125 mm THICK STENCIL  
SCALE:15X

4214839/H 09/2023

NOTES: (continued)

8. Laser cutting apertures with trapezoidal walls and rounded corners may offer better paste release. IPC-7525 may have alternate design recommendations.
9. Board assembly site may have different recommendations for stencil design.



# D0008A



# PACKAGE OUTLINE

## SOIC - 1.75 mm max height

SMALL OUTLINE INTEGRATED CIRCUIT



4214825/C 02/2019

### NOTES:

- Linear dimensions are in inches [millimeters]. Dimensions in parenthesis are for reference only. Controlling dimensions are in inches. Dimensioning and tolerancing per ASME Y14.5M.
- This drawing is subject to change without notice.
- This dimension does not include mold flash, protrusions, or gate burrs. Mold flash, protrusions, or gate burrs shall not exceed .006 [0.15] per side.
- This dimension does not include interlead flash.
- Reference JEDEC registration MS-012, variation AA.

# EXAMPLE BOARD LAYOUT

D0008A

SOIC - 1.75 mm max height

SMALL OUTLINE INTEGRATED CIRCUIT



LAND PATTERN EXAMPLE  
 EXPOSED METAL SHOWN  
 SCALE:8X



SOLDER MASK DETAILS

4214825/C 02/2019

NOTES: (continued)

- 6. Publication IPC-7351 may have alternate designs.
- 7. Solder mask tolerances between and around signal pads can vary based on board fabrication site.

# EXAMPLE STENCIL DESIGN

D0008A

SOIC - 1.75 mm max height

SMALL OUTLINE INTEGRATED CIRCUIT



SOLDER PASTE EXAMPLE  
BASED ON .005 INCH [0.125 MM] THICK STENCIL  
SCALE:8X

4214825/C 02/2019

NOTES: (continued)

8. Laser cutting apertures with trapezoidal walls and rounded corners may offer better paste release. IPC-7525 may have alternate design recommendations.
9. Board assembly site may have different recommendations for stencil design.

P (R-PDIP-T8)

PLASTIC DUAL-IN-LINE PACKAGE



- NOTES:
- A. All linear dimensions are in inches (millimeters).
  - B. This drawing is subject to change without notice.
  - C. Falls within JEDEC MS-001 variation BA.

DGK (S-PDSO-G8)

PLASTIC SMALL-OUTLINE PACKAGE



4073329/E 05/06

- NOTES:
- A. All linear dimensions are in millimeters.
  - B. This drawing is subject to change without notice.
  - C. Body length does not include mold flash, protrusions, or gate burrs. Mold flash, protrusions, or gate burrs shall not exceed 0.15 per end.
  - D. Body width does not include interlead flash. Interlead flash shall not exceed 0.50 per side.
  - E. Falls within JEDEC MO-187 variation AA, except interlead flash.



- NOTES:
- A. All linear dimensions are in millimeters.
  - B. This drawing is subject to change without notice.
  - C. Publication IPC-7351 is recommended for alternate designs.
  - D. Laser cutting apertures with trapezoidal walls and also rounding corners will offer better paste release. Customers should contact their board assembly site for stencil design recommendations. Refer to IPC-7525 for other stencil recommendations.
  - E. Customers should contact their board fabrication site for solder mask tolerances between and around signal pads.

PW0008A



PACKAGE OUTLINE  
TSSOP - 1.2 mm max height

SMALL OUTLINE PACKAGE



4221848/A 02/2015

NOTES:

1. All linear dimensions are in millimeters. Any dimensions in parenthesis are for reference only. Dimensioning and tolerancing per ASME Y14.5M.
2. This drawing is subject to change without notice.
3. This dimension does not include mold flash, protrusions, or gate burrs. Mold flash, protrusions, or gate burrs shall not exceed 0.15 mm per side.
4. This dimension does not include interlead flash. Interlead flash shall not exceed 0.25 mm per side.
5. Reference JEDEC registration MO-153, variation AA.

# EXAMPLE BOARD LAYOUT

PW0008A

TSSOP - 1.2 mm max height

SMALL OUTLINE PACKAGE



LAND PATTERN EXAMPLE  
SCALE:10X



SOLDER MASK DETAILS  
NOT TO SCALE

4221848/A 02/2015

NOTES: (continued)

- 6. Publication IPC-7351 may have alternate designs.
- 7. Solder mask tolerances between and around signal pads can vary based on board fabrication site.



# EXAMPLE STENCIL DESIGN

PW0008A

TSSOP - 1.2 mm max height

SMALL OUTLINE PACKAGE



SOLDER PASTE EXAMPLE  
BASED ON 0.125 mm THICK STENCIL  
SCALE:10X

4221848/A 02/2015

NOTES: (continued)

8. Laser cutting apertures with trapezoidal walls and rounded corners may offer better paste release. IPC-7525 may have alternate design recommendations.
9. Board assembly site may have different recommendations for stencil design.

## IMPORTANT NOTICE AND DISCLAIMER

TI PROVIDES TECHNICAL AND RELIABILITY DATA (INCLUDING DATA SHEETS), DESIGN RESOURCES (INCLUDING REFERENCE DESIGNS), APPLICATION OR OTHER DESIGN ADVICE, WEB TOOLS, SAFETY INFORMATION, AND OTHER RESOURCES "AS IS" AND WITH ALL FAULTS, AND DISCLAIMS ALL WARRANTIES, EXPRESS AND IMPLIED, INCLUDING WITHOUT LIMITATION ANY IMPLIED WARRANTIES OF MERCHANTABILITY, FITNESS FOR A PARTICULAR PURPOSE OR NON-INFRINGEMENT OF THIRD PARTY INTELLECTUAL PROPERTY RIGHTS.

These resources are intended for skilled developers designing with TI products. You are solely responsible for (1) selecting the appropriate TI products for your application, (2) designing, validating and testing your application, and (3) ensuring your application meets applicable standards, and any other safety, security, regulatory or other requirements.

These resources are subject to change without notice. TI grants you permission to use these resources only for development of an application that uses the TI products described in the resource. Other reproduction and display of these resources is prohibited. No license is granted to any other TI intellectual property right or to any third party intellectual property right. TI disclaims responsibility for, and you will fully indemnify TI and its representatives against, any claims, damages, costs, losses, and liabilities arising out of your use of these resources.

TI's products are provided subject to [TI's Terms of Sale](#) or other applicable terms available either on [ti.com](https://www.ti.com) or provided in conjunction with such TI products. TI's provision of these resources does not expand or otherwise alter TI's applicable warranties or warranty disclaimers for TI products.

TI objects to and rejects any additional or different terms you may have proposed.

Mailing Address: Texas Instruments, Post Office Box 655303, Dallas, Texas 75265  
Copyright © 2023, Texas Instruments Incorporated