

TPA152 75-mW STEREO AUDIO POWER AMPLIFIER

SLOS210A – JUNE 1998 – REVISED MARCH 2000

- High-Fidelity Line-Out/HP Driver
- 75-mW Stereo Output
- PC Power Supply Compatible
- Pop Reduction Circuitry
- Internal Mid-Rail Generation
- Thermal and Short-Circuit Protection
- Surface-Mount Packaging
- Pin Compatible With TPA302

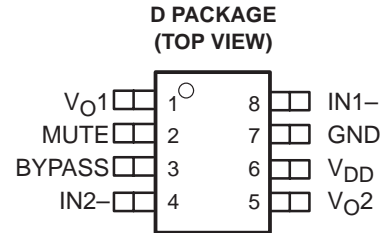

description

The TPA152 is a stereo audio power amplifier capable of less than 0.1% THD+N at 1 kHz when delivering 75 mW per channel into a 32- Ω load. THD+N is less than 0.2% across the audio band of 20 to 20 kHz. For 10 k Ω loads, the THD+N performance is better than 0.005% at 1 kHz, and less than 0.01% across the audio band of 20 to 20 kHz.

The TPA152 is ideal for use as an output buffer for the audio CODEC in PC systems. It is also excellent for use where a high-performance head phone/line-out amplifier is needed. Depop circuitry is integrated to reduce transients during power up, power down, and mute mode.

Amplifier gain is externally configured by means of two resistors per input channel and does not require external compensation for settings of 1 to 10. The TPA152 is packaged in the 8-pin SOIC (D) package that reduces board space and facilitates automated assembly.

typical application circuit

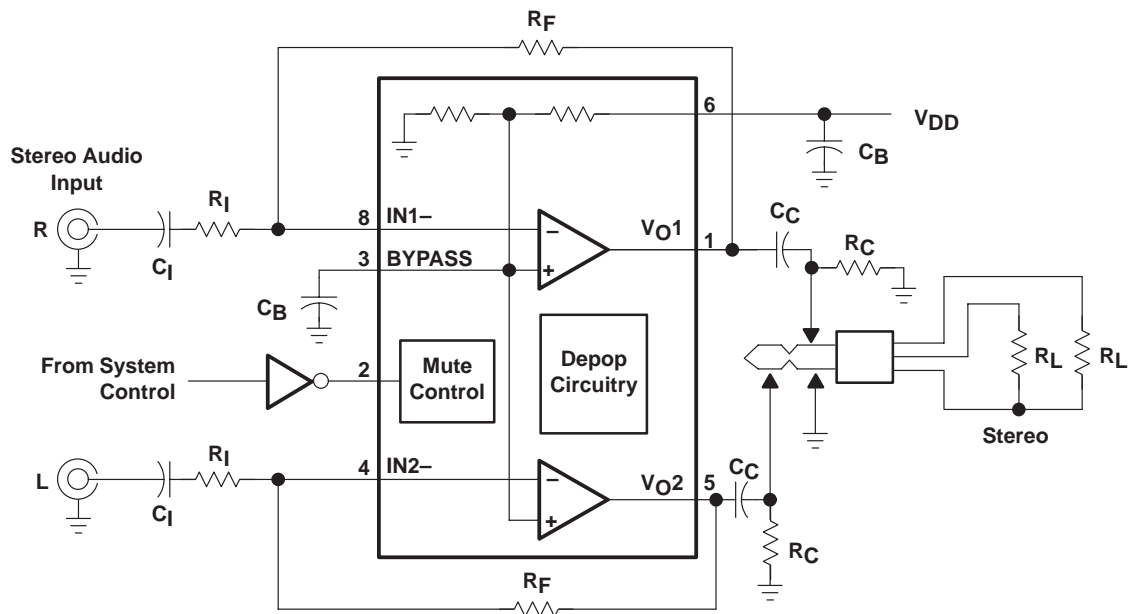

PRODUCTION DATA information is current as of publication date. Products conform to specifications per the terms of Texas Instruments standard warranty. Production processing does not necessarily include testing of all parameters.

 **TEXAS
INSTRUMENTS**

POST OFFICE BOX 655303 • DALLAS, TEXAS 75265

Copyright © 2000, Texas Instruments Incorporated

TPA152

75-mW STEREO AUDIO POWER AMPLIFIER

SLOS210A – JUNE 1998 – REVISED MARCH 2000

AVAILABLE OPTIONS

T_A	PACKAGED DEVICE
	SMALL OUTLINE
–40°C to 85°C	TPA152D†

† The D packages are available taped and reeled. To order a taped and reeled part, add the suffix R (e.g., TPA152DR)

Terminal Functions

TERMINAL NAME	NO.	I/O	DESCRIPTION
BYPASS	3		BYPASS is the tap to the voltage divider for internal mid-supply bias. This terminal should be connected to a 0.1- μ F to 1- μ F capacitor.
GND	7		GND is the ground connection.
IN1–	8	I	IN1– is the inverting input for channel 1.
IN2–	4	I	IN2– is the inverting input for channel 2.
MUTE	2	I	A logic high puts the device into MUTE mode.
VDD	6	I	VDD is the supply voltage terminal.
VO1	1	O	VO1 is the audio output for channel 1.
VO2	5	O	VO2 is the audio output for channel 1.



POST OFFICE BOX 655303 • DALLAS, TEXAS 75265

TPA152

75-mW STEREO AUDIO POWER AMPLIFIER

SLOS210A – JUNE 1998 – REVISED MARCH 2000

absolute maximum ratings over operating free-air temperature range (unless otherwise noted)†

Supply voltage, V_{DD}	6 V
Input voltage, V_I	–0.3 V to $V_{DD} + 0.3$ V
Continuous total power dissipation	internally limited (See Dissipation Rating Table)
Operating junction temperature range, T_J	–40°C to 150°C
Operating case temperature range, T_C	–40°C to 125°C
Storage temperature range, T_{stg}	–65°C to 150°C
Lead temperature 1,6 mm (1/16 inch) from case for 10 seconds	260°C

† Stresses beyond those listed under “absolute maximum ratings” may cause permanent damage to the device. These are stress ratings only, and functional operation of the device at these or any other conditions beyond those indicated under “recommended operating conditions” is not implied. Exposure to absolute-maximum-rated conditions for extended periods may affect device reliability.

DISSIPATION RATING TABLE

PACKAGE	$T_A \leq 25^\circ\text{C}$	DERATING FACTOR	$T_A = 70^\circ\text{C}$	$T_A = 85^\circ\text{C}$
D	724 mW	5.8 mW/°C	464 mW	376 mW

recommended operating conditions

	MIN	MAX	UNIT
Supply voltage, V_{DD}	4.5	5.5	V
Operating free-air temperature, T_A	–40	85	°C

dc electrical characteristics at $T_A = 25^\circ\text{C}$, $V_{DD} = 5$ V

PARAMETER	TEST CONDITIONS	MIN	TYP	MAX	UNIT
V_{OO} Output offset voltage				10	mV
Supply ripple rejection ratio	$V_{DD} = 4.9$ V to 5.1 V		81		dB
I_{DD} Supply current	See Figure 13		5.5	14	mA
$I_{DD}(\text{MUTE})$ Supply current in MUTE			5.5	14	mA
Z_I Input impedance			>1		M Ω

ac operating characteristics $V_{DD} = 5$ V, $T_A = 25^\circ\text{C}$, $R_L = 32 \Omega$ (unless otherwise noted)

PARAMETER	TEST CONDITIONS	MIN	TYP	MAX	UNIT
P_O Output power (each channel)	THD $\leq 0.03\%$, Gain = 1, See Figure 1		75†		mW
THD+N Total harmonic distortion plus noise	$P_O = 75$ mW, 20 Hz–20 kHz, Gain = 1, See Figure 2		0.2%		
B_{OM} Maximum output power bandwidth	$A_V = 5$, THD $< 0.6\%$, See Figure 2		>20		kHz
Phase margin	Open loop, See Figure 16		80°		
Supply ripple rejection ratio	1 kHz, $C_B = 1 \mu\text{F}$, See Figure 12		65		dB
Mute attenuation	See Figure 15		110		dB
Ch/Ch output separation	See Figure 13		102		dB
Signal-to-Noise ratio	$V_O = 1$ V(rms), Gain = 1 See Figure 11		104		dB
V_N Noise output voltage	See Figure 10		6		$\mu\text{V}(\text{rms})$

† Measured at 1 kHz.

- NOTES: 1. The dc output voltage is approximately $V_{DD}/2$.
 2. Output power is measured at the output pins of the IC at 1 kHz.



TPA152

75-mW STEREO AUDIO POWER AMPLIFIER

SLOS210A – JUNE 1998 – REVISED MARCH 2000

ac operating characteristics $V_{DD} = 5\text{ V}$, $T_A = 25^\circ\text{C}$, $R_L = 10\text{ k}\Omega$

PARAMETER	TEST CONDITIONS	MIN	TYP	MAX	UNIT
THD+N Total harmonic distortion plus noise	$V_I = 1\text{ V}_{(rms)}$, See Figure 6		0.005%		
	$V_O(PP) = 4\text{ V}$, See Figure 8		0.005%		
BOM Maximum output power bandwidth	$G = 5$, THD <0.02%, See Figure 6		>20		kHz
Phase margin	Open loop, See Figure 16		80°		
k_{SVR} Supply voltage rejection ratio	1 kHz, $C_B = 1\text{ }\mu\text{F}$, See Figure 12		65		dB
Mute attenuation	See Figure 15		110		dB
Ch/Ch output separation	See Figure 13		102		dB
Signal-to-Noise ratio	$V_O = 1\text{ V}_{(rms)}$, Gain = 1, See Figure 11		104		dB
V_n Noise output voltage	See Figure 10		6		$\mu\text{V}_{(rms)}$

† Measured at 1 kHz.

TYPICAL CHARACTERISTICS

Table of Graphs

		FIGURE
THD+N Total harmonic distortion plus noise	vs Output power	1, 4
THD+N Total harmonic distortion plus noise	vs Frequency	2, 3, 6, 8, 9
THD+N Total harmonic distortion plus noise	vs Output voltage	5, 7
V_n Output noise voltage	vs Frequency	10
SNR Signal-to-noise ratio	vs Gain	11
Supply ripple rejection ratio	vs Frequency	12
Crosstalk	vs Frequency	13, 14
Mute Attenuation	vs Frequency	15
Open-loop gain and phase	vs Frequency	16, 17
Closed-loop gain and phase	vs Frequency	18
I_{DD} Supply current	vs Supply voltage	19
P_O Output power	vs Load resistance	20
P_D Power dissipation	vs Output power	21



TYPICAL CHARACTERISTICS

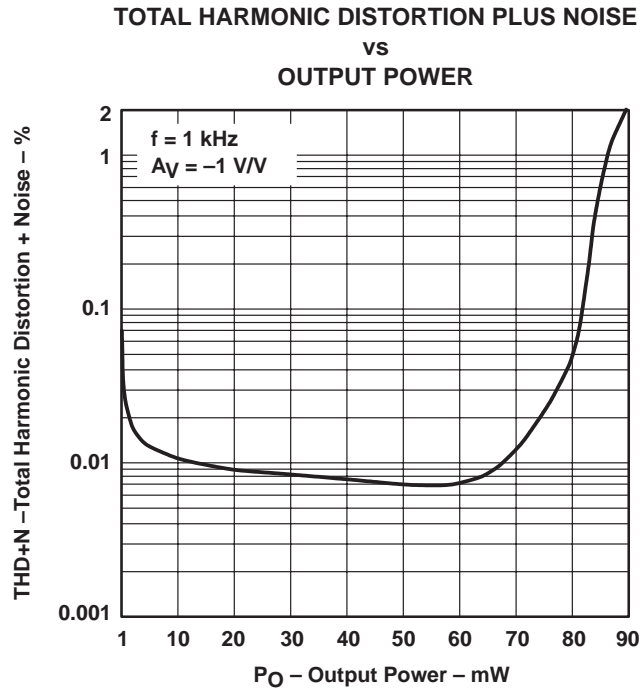

Figure 1

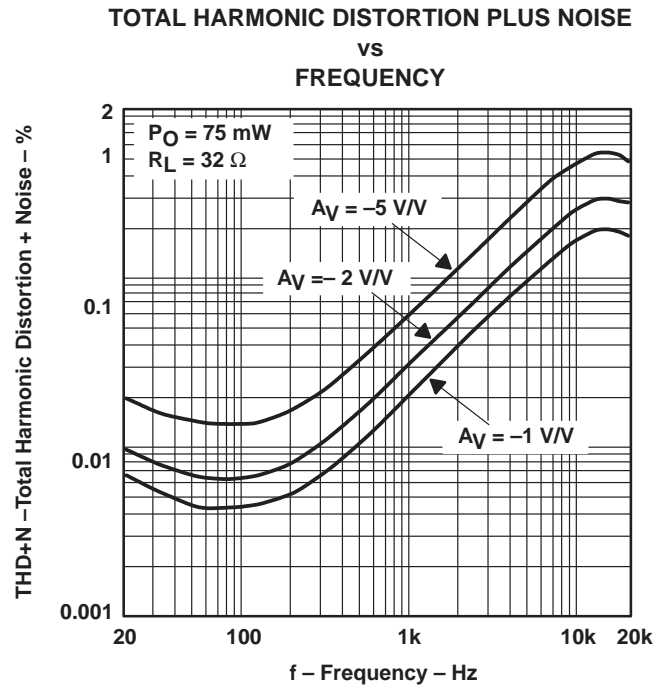

Figure 2

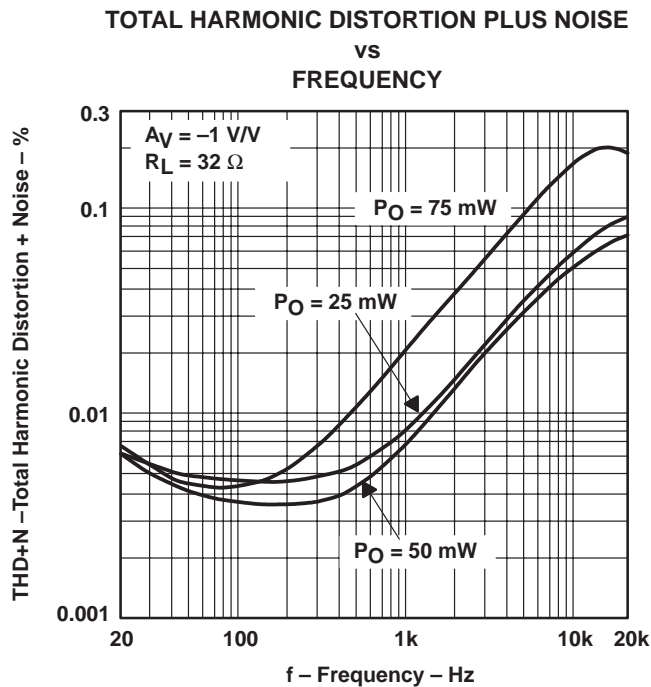

Figure 3

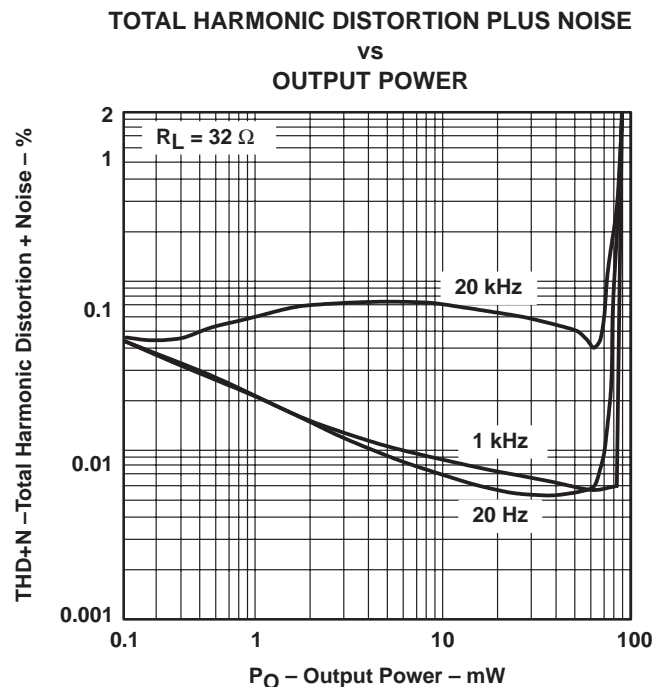

Figure 4

TPA152 75-mW STEREO AUDIO POWER AMPLIFIER

SLOS210A – JUNE 1998 – REVISED MARCH 2000

TYPICAL CHARACTERISTICS

TOTAL HARMONIC DISTORTION PLUS NOISE
vs
OUTPUT VOLTAGE

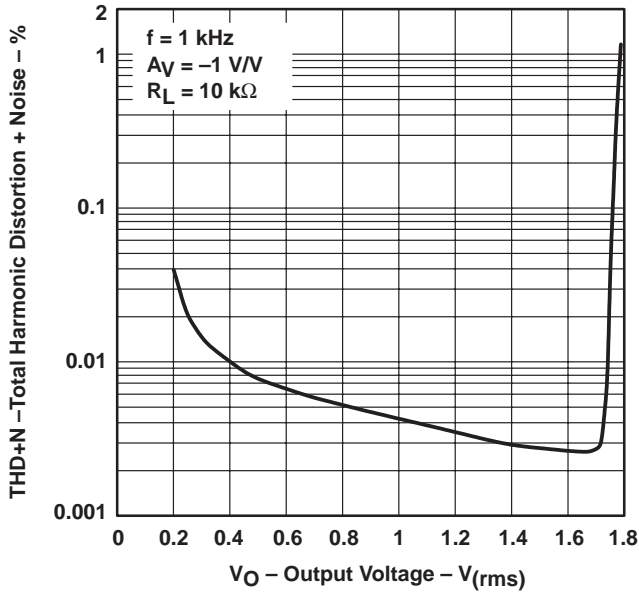

Figure 5

TOTAL HARMONIC DISTORTION PLUS NOISE
vs
FREQUENCY

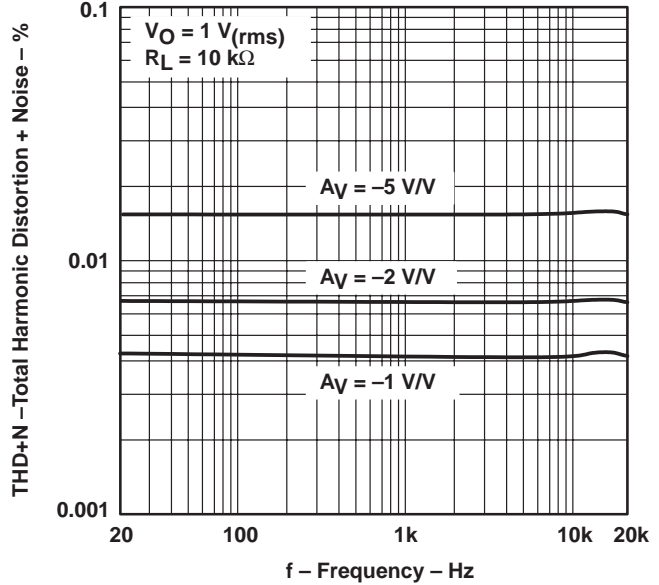

Figure 6

TOTAL HARMONIC DISTORTION PLUS NOISE
vs
OUTPUT VOLTAGE

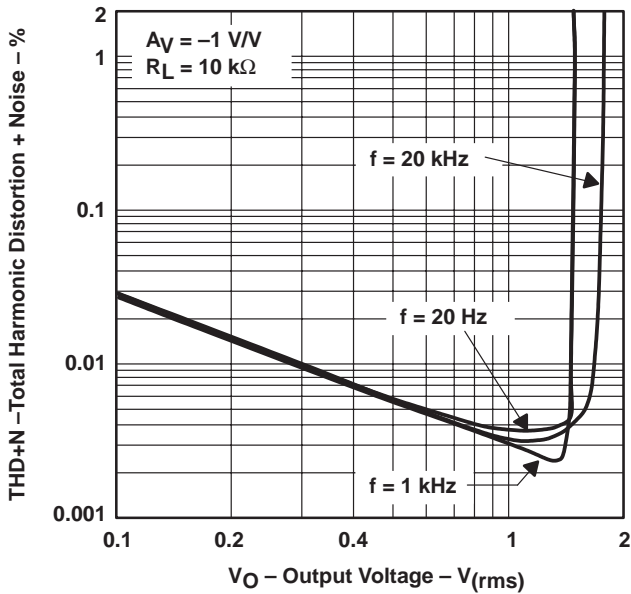

Figure 7

TOTAL HARMONIC DISTORTION PLUS NOISE
vs
FREQUENCY

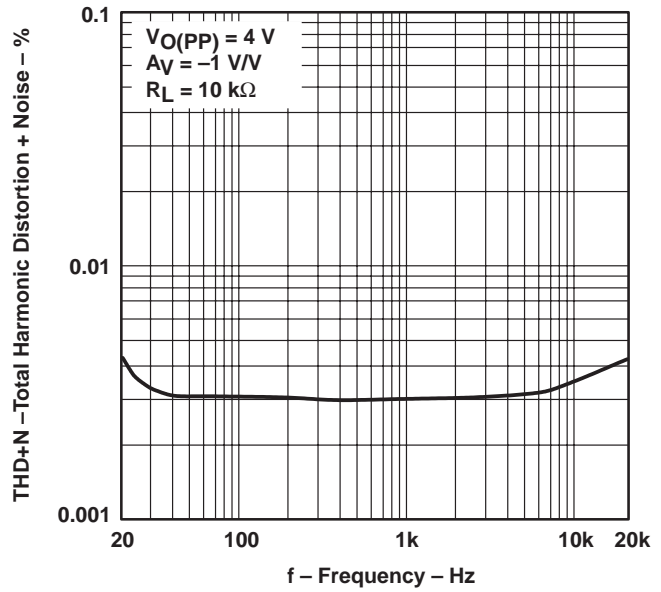

Figure 8



TYPICAL CHARACTERISTICS

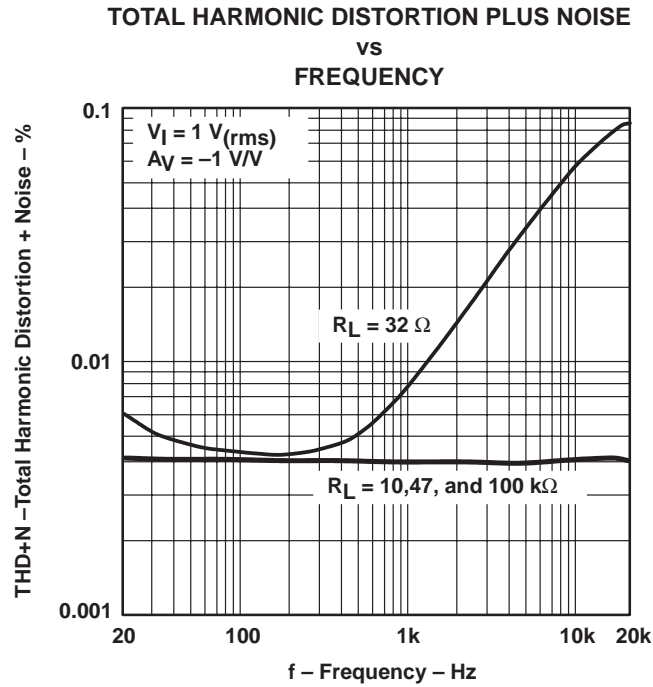

Figure 9

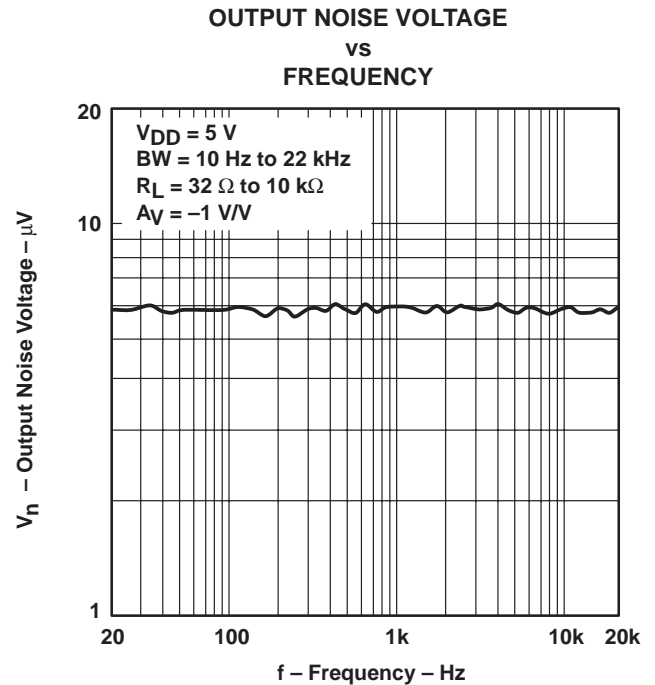

Figure 10

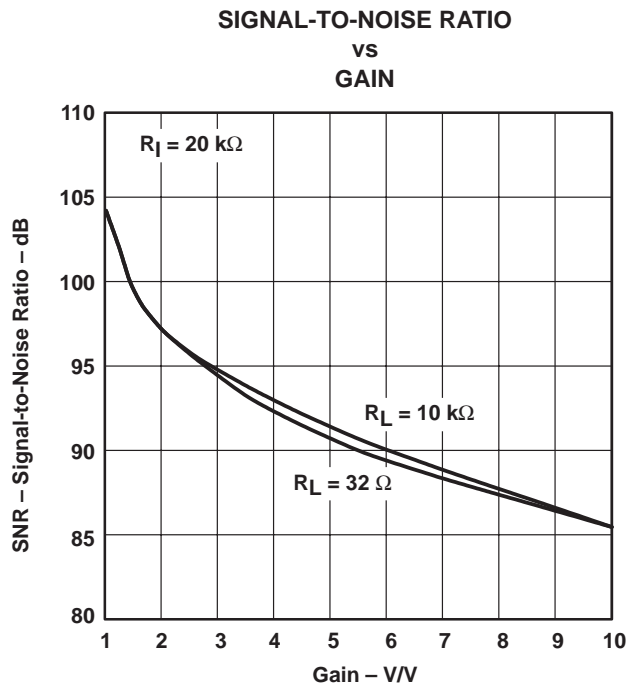

Figure 11

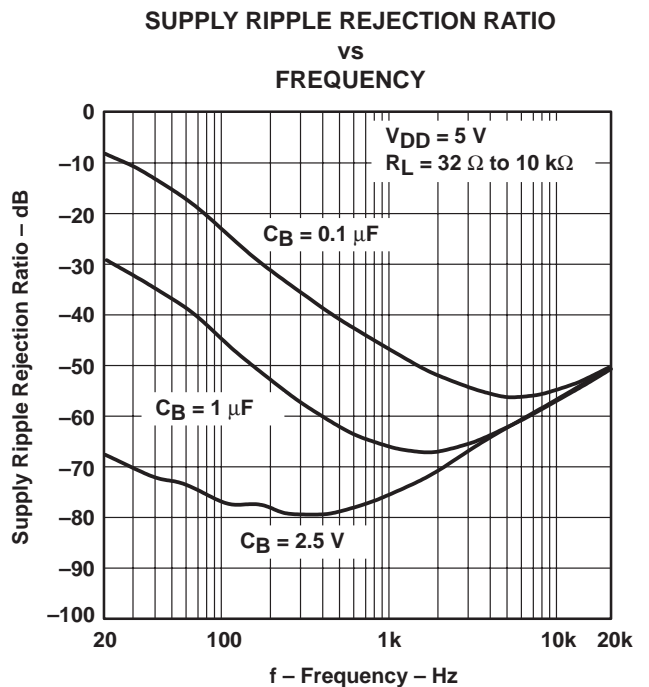

Figure 12

TPA152 75-mW STEREO AUDIO POWER AMPLIFIER

SLOS210A – JUNE 1998 – REVISED MARCH 2000

TYPICAL CHARACTERISTICS

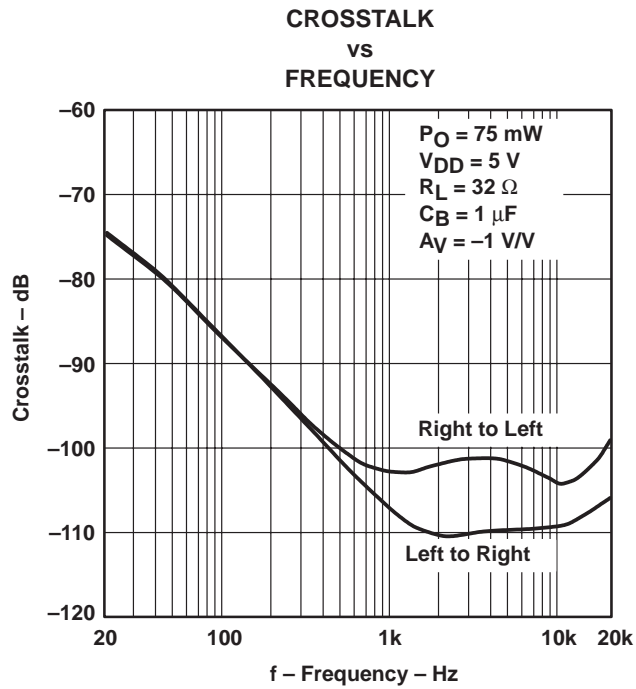

Figure 13

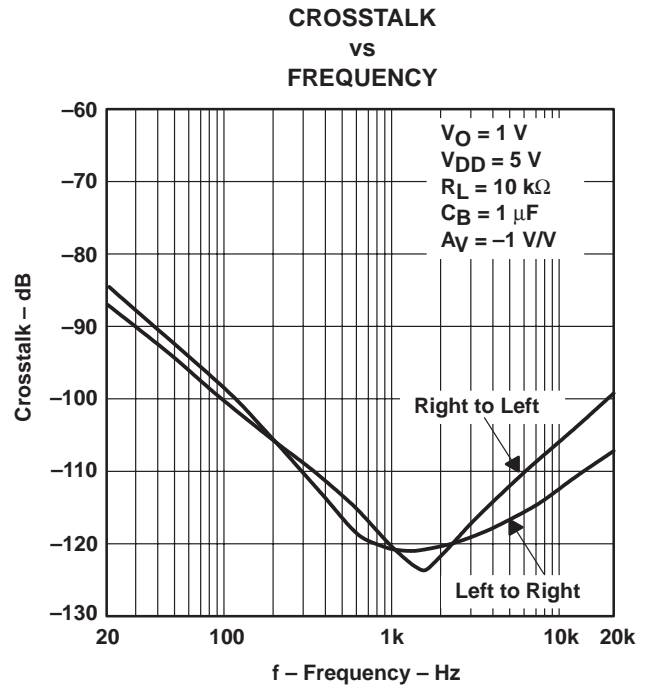

Figure 14

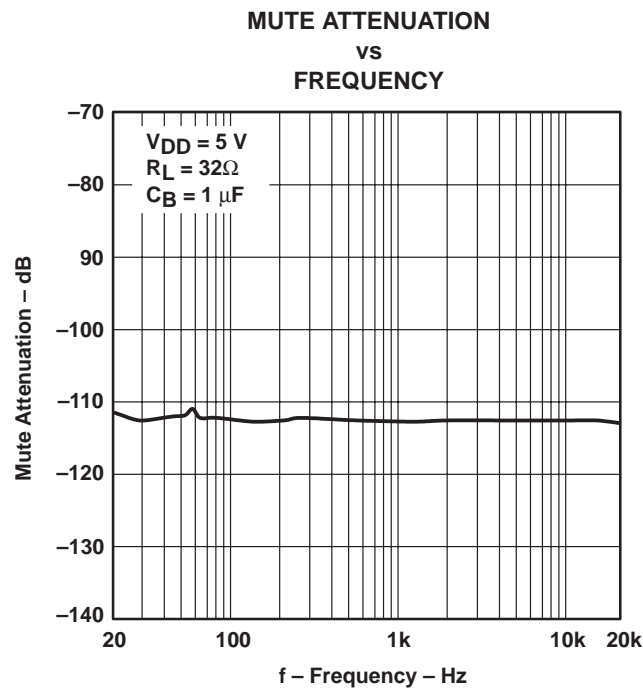

Figure 15



TYPICAL CHARACTERISTICS

OPEN-LOOP GAIN AND PHASE
vs
FREQUENCY

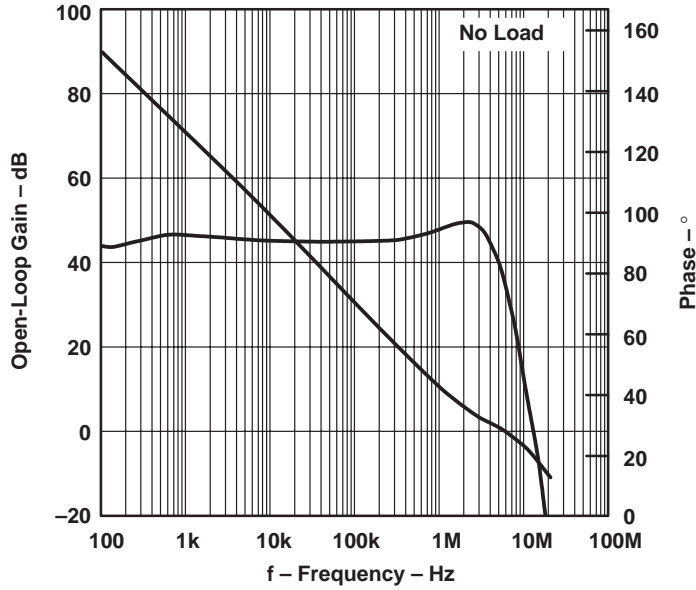

Figure 16

CLOSED-LOOP GAIN AND PHASE
vs
FREQUENCY

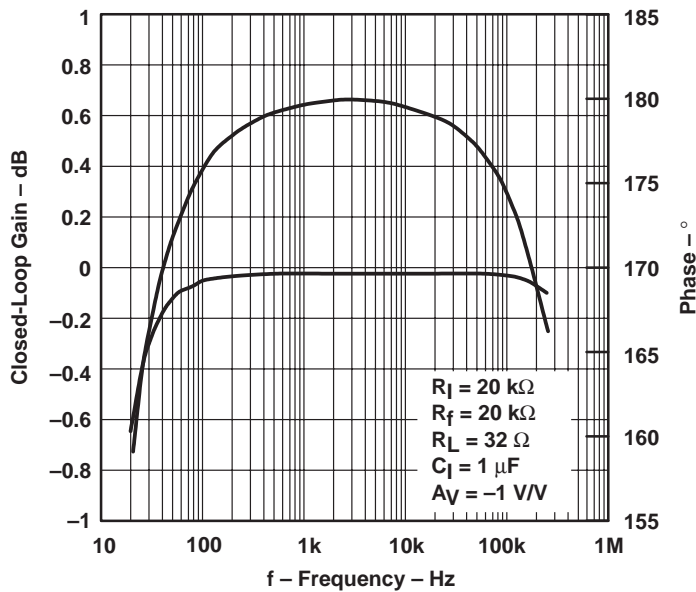

Figure 17

TYPICAL CHARACTERISTICS

CLOSED-LOOP GAIN AND PHASE
VS
FREQUENCY

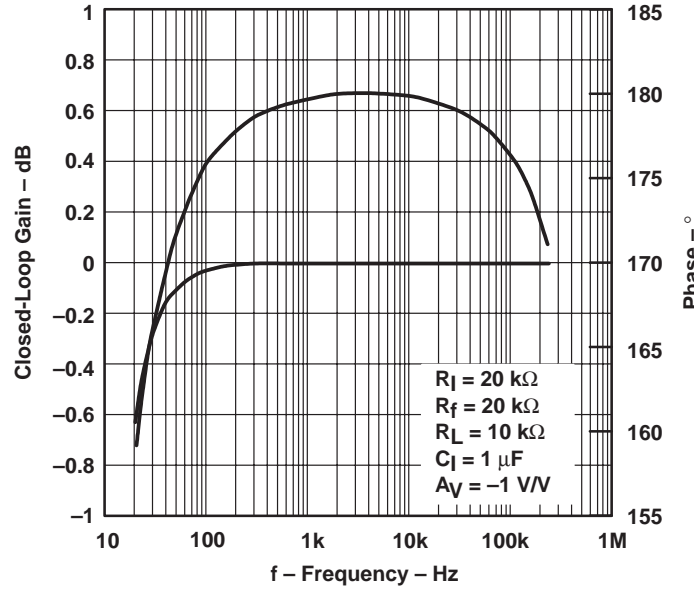

Figure 18

SUPPLY CURRENT
VS
SUPPLY VOLTAGE

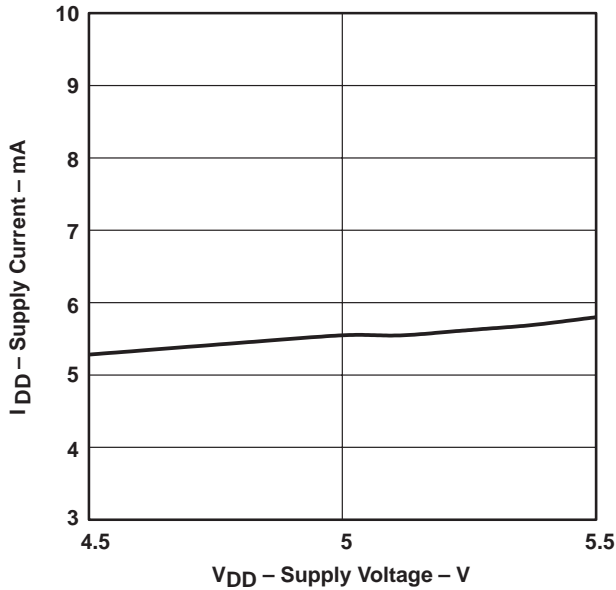

Figure 19

OUTPUT POWER
VS
LOAD RESISTANCE

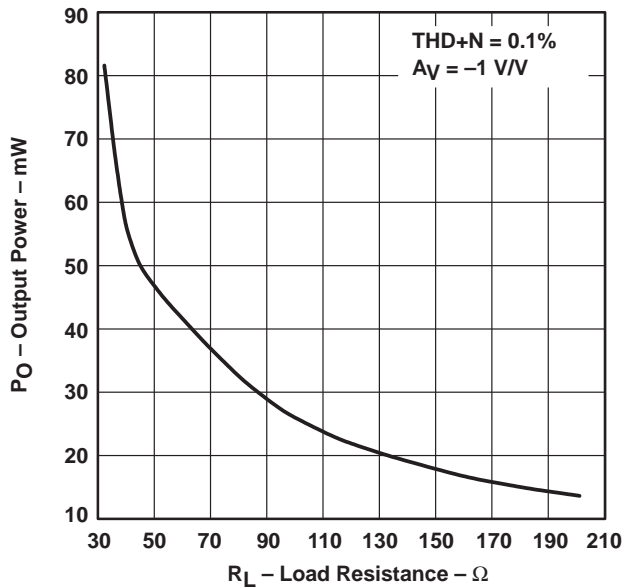

Figure 20

TYPICAL CHARACTERISTICS

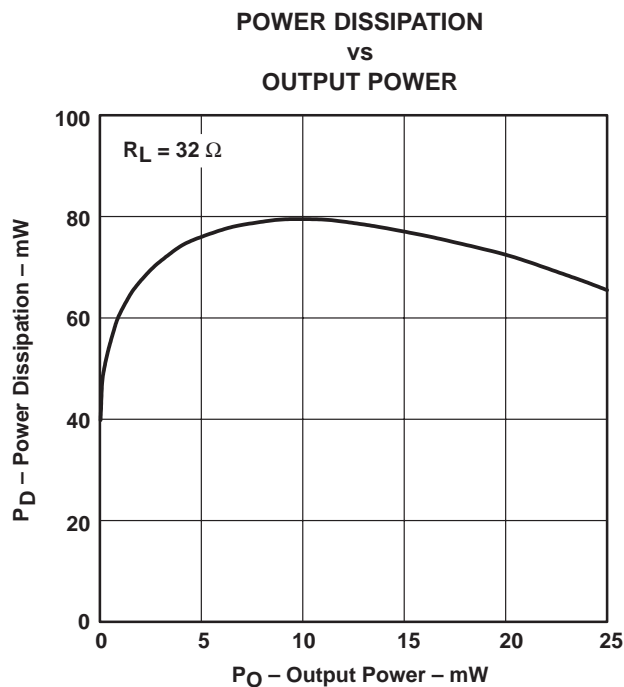
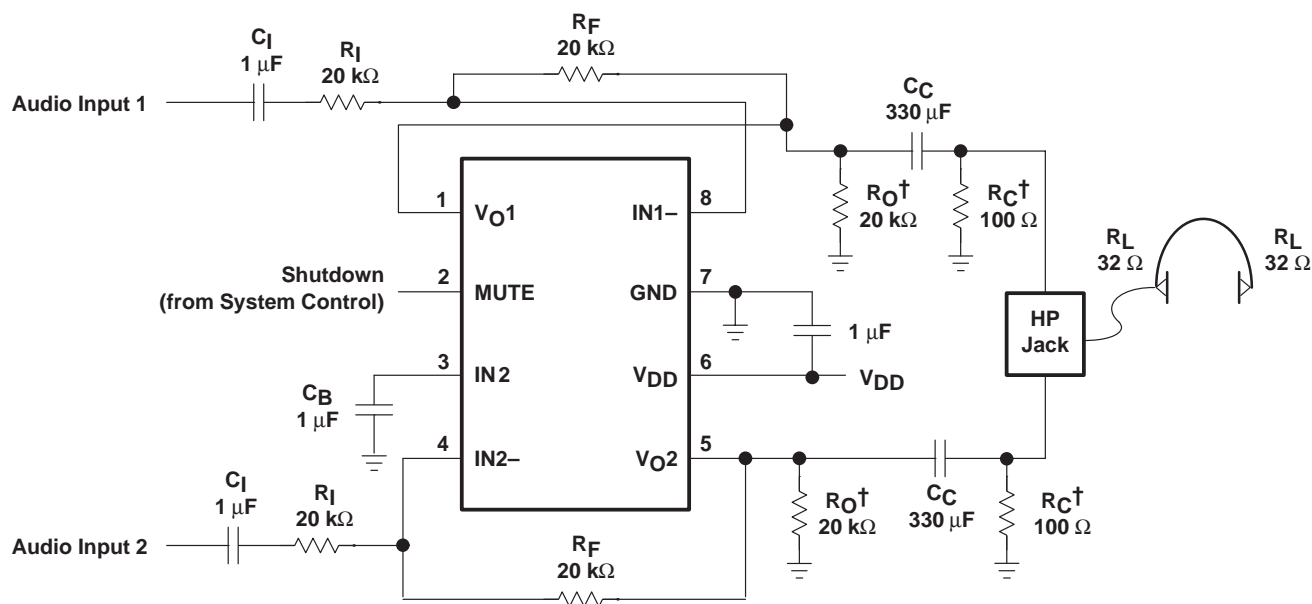

Figure 21

APPLICATION INFORMATION

selection of components

Figure 22 is a schematic diagram of a typical application circuit.



† These resistors are optional. Adding these resistors improves the depop performance of the TPA152.

Figure 22. TPA152 Typical Application Circuit

TPA152

75-mW STEREO AUDIO POWER AMPLIFIER

SLOS210A – JUNE 1998 – REVISED MARCH 2000

APPLICATION INFORMATION

gain setting resistors, R_F and R_I

The gain for the TPA152 is set by resistors R_F and R_I according to equation 1.

$$\text{Gain} = - \left(\frac{R_F}{R_I} \right) \quad (1)$$

Given that the TPA152 is a MOS amplifier, the input impedance is very high, consequently input leakage currents are not generally a concern although noise in the circuit increases as the value of R_F increases. In addition, a certain range of R_F values are required for proper start-up operation of the amplifier. Taken together it is recommended that the effective impedance seen by the inverting node of the amplifier be set between 5 k Ω and 20 k Ω . The effective impedance is calculated in equation 2.

$$\text{Effective Impedance} = \frac{R_F R_I}{R_F + R_I} \quad (2)$$

As an example, consider an input resistance of 20 k Ω and a feedback resistor of 20 k Ω . The gain of the amplifier would be -1 and the effective impedance at the inverting terminal would be 10 k Ω , which is within the recommended range.

For high performance applications, metal film resistors are recommended because they tend to have lower noise levels than carbon resistors. For values of R_F above 50 k Ω , the amplifier tends to become unstable due to a pole formed from R_F and the inherent input capacitance of the MOS input structure. For this reason, a small compensation capacitor of approximately 5 pF should be placed in parallel with R_F . This, in effect, creates a low-pass filter network with the cutoff frequency defined in equation 3.

$$f_{c(\text{lowpass})} = \frac{1}{2\pi R_F C_F} \quad (3)$$

For example if R_F is 100 k Ω and C_F is 5 pF then $f_{c(\text{lowpass})}$ is 318 kHz, which is well outside the audio range.

input capacitor, C_I

In the typical application, an input capacitor, C_I , is required to allow the amplifier to bias the input signal to the proper dc level for optimum operation. In this case, C_I and R_I form a high-pass filter with the corner frequency determined in equation 4.

$$f_{c(\text{highpass})} = \frac{1}{2\pi R_I C_I} \quad (4)$$

The value of C_I is important to consider as it directly affects the bass (low frequency) performance of the circuit. Consider the example where R_I is 20 k Ω and the specification calls for a flat bass response down to 20 Hz. Equation 4 is reconfigured as equation 5.

$$C_I = \frac{1}{2\pi R_I f_{c(\text{highpass})}} \quad (5)$$

In this example, C_I is 0.40 μF , so one would likely choose a value in the range of 0.47 μF to 1 μF . A further consideration for this capacitor is the leakage path from the input source through the input network (R_I , C_I) and the feedback resistor (R_F) to the load. This leakage current creates a dc offset voltage at the input to the amplifier that reduces useful headroom, especially in high-gain applications (> 10). For this reason a low-leakage tantalum or ceramic capacitor is the best choice. When polarized capacitors are used, the positive side of the capacitor should face the amplifier input in most applications, as the dc level there is held at $V_{DD}/2$, which is likely higher than the source dc level. Please note that it is important to confirm the capacitor polarity in the application.

APPLICATION INFORMATION

power supply decoupling, C_S

The TPA152 is a high-performance CMOS audio amplifier that requires adequate power supply decoupling to ensure that the output total harmonic distortion (THD) is as low as possible. Power supply decoupling also prevents oscillations for long lead lengths between the amplifier and the speaker. The optimum decoupling is achieved by using two capacitors of different types that target different types of noise on the power supply leads. For higher frequency transients, spikes, or digital hash on the line, a good low equivalent-series-resistance (ESR) ceramic capacitor, typically 0.1 μF , placed as close as possible to the device V_{DD} lead, works best. For filtering lower-frequency noise signals, a larger aluminum electrolytic capacitor of 10 μF or greater placed near the power amplifier is recommended.

midrail bypass capacitor, C_B

The midrail bypass capacitor, C_B , serves several important functions. During startup or recovery from shutdown mode, C_B determines the rate at which the amplifier starts up. This helps to push the start-up pop noise into the subaudible range (so slow it can not be heard). The second function is to reduce noise produced by the power supply caused by coupling into the output drive signal. This noise is from the midrail generation circuit internal to the amplifier. The capacitor is fed from a 160-k Ω source inside the amplifier. To keep the start-up pop as low as possible, the relationship shown in equation 6 should be maintained.

$$\frac{1}{(C_B \times 160 \text{ k}\Omega)} \leq \frac{1}{(C_I R_I)} \quad (6)$$

As an example, consider a circuit where C_B is 1 μF , C_I is 1 μF and R_I is 20 k Ω . Inserting these values into the equation 9 results in:

$$6.25 \leq 50$$

which satisfies the rule. Bypass capacitor, C_B , values of 0.1 μF to 1 μF ceramic or tantalum low-ESR capacitors are recommended for the best THD and noise performance.

output coupling capacitor, C_C

In the typical single-supply single-ended (SE) configuration, an output coupling capacitor (C_C) is required to block the dc bias at the output of the amplifier thus preventing dc currents in the load. As with the input coupling capacitor, the output coupling capacitor and impedance of the load form a high-pass filter governed by equation 7.

$$f_{c(\text{high})} = \frac{1}{2\pi R_L C_C} \quad (7)$$

The main disadvantage, from a performance standpoint, is that the load impedances are typically small, which drive the low-frequency corner higher. Large values of C_C are required to pass low frequencies into the load. Consider the example where a C_C of 68 μF is chosen and loads vary from 32 Ω to 47 k Ω . Table 1 summarizes the frequency response characteristics of each configuration.

APPLICATION INFORMATION

Table 1. Common Load Impedances vs Low Frequency Output Characteristics in SE Mode

R_L	C_C	LOWEST FREQUENCY
32 Ω	68 μF	73 Hz
10,000 Ω	68 μF	0.23 Hz
47,000 Ω	68 μF	0.05 Hz

As Table 1 indicates, headphone response is adequate and drive into line level inputs (a home stereo for example) is very good.

The output coupling capacitor required in single-supply SE mode also places additional constraints on the selection of other components in the amplifier circuit. With the rules described earlier still valid, add the following relationship:

$$\frac{1}{(C_B \times 160 \text{ k}\Omega)} \leq \frac{1}{(C_I R_I)} \ll \frac{1}{R_L C_C} \tag{8}$$

output pull-down resistor, R_C + R_O

Placing a 100-Ω resistor, R_C, from the output side of the coupling capacitor to ground insures the coupling capacitor, C_C, is charged before a plug is inserted into the jack. Without this resistor, the coupling capacitor would charge rapidly upon insertion of a plug, leading to an audible pop in the headphones.

Placing a 20-kΩ resistor, R_O, from the output of the IC to ground insures that the coupling capacitor fully discharges at power down. If the supply is rapidly cycled without this capacitor, a small pop may be audible in 10-kΩ loads.

using low-ESR capacitors

Low-ESR capacitors are recommended throughout this applications section. A real capacitor can be modeled simply as a resistor in series with an ideal capacitor. The voltage drop across this resistor minimizes the beneficial effects of the capacitor in the circuit. The lower the equivalent value of this resistance, the more the real capacitor behaves like an ideal capacitor.



PACKAGING INFORMATION

Orderable Device	Status (1)	Package Type	Package Drawing	Pins	Package Qty	Eco Plan (2)	Lead finish/ Ball material (6)	MSL Peak Temp (3)	Op Temp (°C)	Device Marking (4/5)	Samples
TPA152D	ACTIVE	SOIC	D	8	75	RoHS & Green	NIPDAU	Level-1-260C-UNLIM	-40 to 85	TPA152	Samples
TPA152DR	ACTIVE	SOIC	D	8	2500	RoHS & Green	NIPDAU	Level-1-260C-UNLIM	-40 to 85	TPA152	Samples

(1) The marketing status values are defined as follows:

ACTIVE: Product device recommended for new designs.

LIFEBUY: TI has announced that the device will be discontinued, and a lifetime-buy period is in effect.

NRND: Not recommended for new designs. Device is in production to support existing customers, but TI does not recommend using this part in a new design.

PREVIEW: Device has been announced but is not in production. Samples may or may not be available.

OBSOLETE: TI has discontinued the production of the device.

(2) **RoHS:** TI defines "RoHS" to mean semiconductor products that are compliant with the current EU RoHS requirements for all 10 RoHS substances, including the requirement that RoHS substance do not exceed 0.1% by weight in homogeneous materials. Where designed to be soldered at high temperatures, "RoHS" products are suitable for use in specified lead-free processes. TI may reference these types of products as "Pb-Free".

RoHS Exempt: TI defines "RoHS Exempt" to mean products that contain lead but are compliant with EU RoHS pursuant to a specific EU RoHS exemption.

Green: TI defines "Green" to mean the content of Chlorine (Cl) and Bromine (Br) based flame retardants meet JS709B low halogen requirements of <=1000ppm threshold. Antimony trioxide based flame retardants must also meet the <=1000ppm threshold requirement.

(3) MSL, Peak Temp. - The Moisture Sensitivity Level rating according to the JEDEC industry standard classifications, and peak solder temperature.

(4) There may be additional marking, which relates to the logo, the lot trace code information, or the environmental category on the device.

(5) Multiple Device Markings will be inside parentheses. Only one Device Marking contained in parentheses and separated by a "-" will appear on a device. If a line is indented then it is a continuation of the previous line and the two combined represent the entire Device Marking for that device.

(6) Lead finish/Ball material - Orderable Devices may have multiple material finish options. Finish options are separated by a vertical ruled line. Lead finish/Ball material values may wrap to two lines if the finish value exceeds the maximum column width.

Important Information and Disclaimer:The information provided on this page represents TI's knowledge and belief as of the date that it is provided. TI bases its knowledge and belief on information provided by third parties, and makes no representation or warranty as to the accuracy of such information. Efforts are underway to better integrate information from third parties. TI has taken and continues to take reasonable steps to provide representative and accurate information but may not have conducted destructive testing or chemical analysis on incoming materials and chemicals. TI and TI suppliers consider certain information to be proprietary, and thus CAS numbers and other limited information may not be available for release.

In no event shall TI's liability arising out of such information exceed the total purchase price of the TI part(s) at issue in this document sold by TI to Customer on an annual basis.

TAPE AND REEL INFORMATION

QUADRANT ASSIGNMENTS FOR PIN 1 ORIENTATION IN TAPE

*All dimensions are nominal

Device	Package Type	Package Drawing	Pins	SPQ	Reel Diameter (mm)	Reel Width W1 (mm)	A0 (mm)	B0 (mm)	K0 (mm)	P1 (mm)	W (mm)	Pin1 Quadrant
TPA152DR	SOIC	D	8	2500	330.0	12.4	6.4	5.2	2.1	8.0	12.0	Q1

TAPE AND REEL BOX DIMENSIONS

*All dimensions are nominal

Device	Package Type	Package Drawing	Pins	SPQ	Length (mm)	Width (mm)	Height (mm)
TPA152DR	SOIC	D	8	2500	350.0	350.0	43.0

TUBE

*All dimensions are nominal

Device	Package Name	Package Type	Pins	SPQ	L (mm)	W (mm)	T (μm)	B (mm)
TPA152D	D	SOIC	8	75	505.46	6.76	3810	4

IMPORTANT NOTICE AND DISCLAIMER

TI PROVIDES TECHNICAL AND RELIABILITY DATA (INCLUDING DATA SHEETS), DESIGN RESOURCES (INCLUDING REFERENCE DESIGNS), APPLICATION OR OTHER DESIGN ADVICE, WEB TOOLS, SAFETY INFORMATION, AND OTHER RESOURCES "AS IS" AND WITH ALL FAULTS, AND DISCLAIMS ALL WARRANTIES, EXPRESS AND IMPLIED, INCLUDING WITHOUT LIMITATION ANY IMPLIED WARRANTIES OF MERCHANTABILITY, FITNESS FOR A PARTICULAR PURPOSE OR NON-INFRINGEMENT OF THIRD PARTY INTELLECTUAL PROPERTY RIGHTS.

These resources are intended for skilled developers designing with TI products. You are solely responsible for (1) selecting the appropriate TI products for your application, (2) designing, validating and testing your application, and (3) ensuring your application meets applicable standards, and any other safety, security, regulatory or other requirements.

These resources are subject to change without notice. TI grants you permission to use these resources only for development of an application that uses the TI products described in the resource. Other reproduction and display of these resources is prohibited. No license is granted to any other TI intellectual property right or to any third party intellectual property right. TI disclaims responsibility for, and you will fully indemnify TI and its representatives against, any claims, damages, costs, losses, and liabilities arising out of your use of these resources.

TI's products are provided subject to [TI's Terms of Sale](#) or other applicable terms available either on [ti.com](https://www.ti.com) or provided in conjunction with such TI products. TI's provision of these resources does not expand or otherwise alter TI's applicable warranties or warranty disclaimers for TI products.

TI objects to and rejects any additional or different terms you may have proposed.

Mailing Address: Texas Instruments, Post Office Box 655303, Dallas, Texas 75265
Copyright © 2023, Texas Instruments Incorporated