

THS402x 2-GHz, 10-V/V Stable, Low-Noise, High-Speed Amplifiers

1 Features

- Ultra-low 1.2-nV/ $\sqrt{\text{Hz}}$ voltage noise
- High speed:
 - 2-GHz gain-bandwidth product
 - 470-V/ μs slew rate
 - 30-ns settling time (0.1%)
- Stable at gains ≥ 10 V/V
- Output drive, $I_O = 200$ mA (typical)
- Very low distortion:
 - THD = -68 dBc ($f = 1$ MHz, $R_L = 150 \Omega$)
- Wide range of power supplies:
 - $V_{CC} = \pm 4.5$ V to ± 16 V
- Offset nulling pins on the THS4021

2 Applications

- [Ultrasound scanner](#)
- [Source measurement unit \(SMU\)](#)
- [Power quality meter](#)

3 Description

The THS4021 and THS4022 (THS402x) are ultra-low voltage noise, high-speed voltage feedback amplifiers that are an excellent choice for applications requiring low voltage noise, including communication and imaging. The single-amplifier THS4021 and the dual-amplifier THS4022 offer very good ac performance with 350-MHz bandwidth, 470-V/ μs slew rate, and 30-ns settling time (0.1%). The THS402x are stable at gains of 10 or greater and -9 or less. These amplifiers have a high drive capability of 200 mA and draw only 7.8-mA supply current per amplifier. With a total harmonic distortion (THD) of -68 dBc at $f = 1$ MHz, the THS402x are designed for applications requiring low distortion.

Package Information⁽¹⁾

PART NUMBER	AMPLIFIERS	PACKAGE
THS4021	One	D (SOIC, 8)
		DGN (HVSSOP, 8)
THS4022	Two	D (SOIC, 8)
		DGN (HVSSOP, 8)

(1) For all available packages, see the orderable addendum at the end of the data sheet.

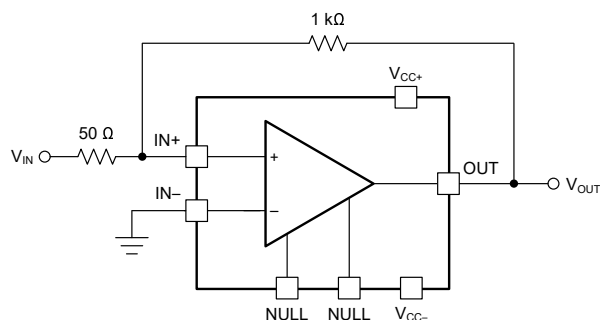

Simplified Application

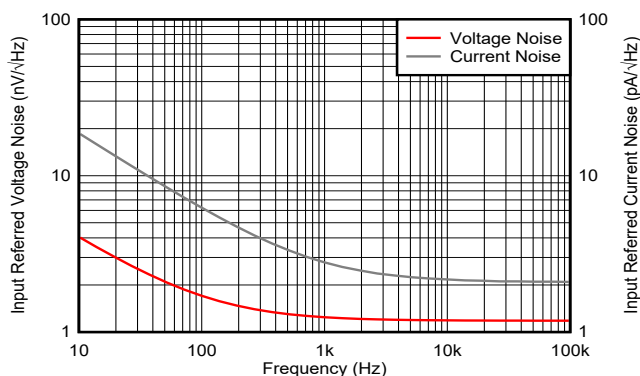

Voltage and Current Noise vs Frequency



Table of Contents

1 Features	1	7.1 Overview.....	22
2 Applications	1	7.2 Functional Block Diagram.....	22
3 Description	1	7.3 Feature Description.....	23
4 Revision History	2	7.4 Device Functional Modes.....	23
5 Pin Configuration and Functions	5	8 Application and Implementation	24
6 Specifications	6	8.1 Application Information.....	24
6.1 Absolute Maximum Ratings.....	6	8.2 Power Supply Recommendations.....	25
6.2 ESD Ratings.....	6	8.3 Layout.....	25
6.3 Recommended Operating Conditions.....	6	9 Device and Documentation Support	28
6.4 Thermal Information: THS4021.....	7	9.1 Documentation Support.....	28
6.5 Thermal Information: THS4022.....	7	9.2 Receiving Notification of Documentation Updates.....	28
6.6 Electrical Characteristics: THS4021 (D Package).....	8	9.3 Support Resources.....	28
6.7 Electrical Characteristics: THS4021 (DGN Package) and THS4022 (D and DGN Packages).....	10	9.4 Trademarks.....	28
6.8 Typical Characteristics: THS4021 (D Package).....	12	9.5 Electrostatic Discharge Caution.....	28
6.9 Typical Characteristics: THS4021 (DGN Package) and THS4022 (D and DGN Packages).....	17	9.6 Glossary.....	28
7 Detailed Description	22	10 Mechanical, Packaging, and Orderable Information	28

4 Revision History

NOTE: Page numbers for previous revisions may differ from page numbers in the current version.

Changes from Revision C (July 2007) to Revision D (May 2023)	Page
• Updated the numbering format for tables, figures, and cross-references throughout the document.....	1
• Added the <i>Applications</i> , <i>Specifications</i> , <i>Application and Implementation</i> , <i>Thermal Information Table</i> , <i>Pin Configuration and Functions</i> , <i>Electrical Characteristics: THS4021xD</i> , <i>Typical Characteristics: THS4021xD</i> , <i>Device and Documentation Support</i> , and <i>Mechanical, Packaging, and Orderable Information</i> sections.....	1
• Changed data sheet title from "350-MHz Low-Noise High-Speed Amplifiers" to "2-GHz, 10-V/V Stable, Low-Noise, High-Speed Amplifiers".....	1
• Changed front-page image from pin diagrams to simplified application.....	1
• Removed <i>Dissipation Ratings</i> section.....	6
• Changed supply voltage max in <i>Absolute Maximum Ratings</i> from ± 16.5 V to 33 V for clarification.....	6
• Changed table note 1 on <i>Absolute Maximum Ratings</i> to add additional clarification.....	6
• Changed output current maximum value in <i>Absolute Maximum Ratings</i> from 150 mA to 240 mA.....	6
• Changed differential supply voltage maximum in <i>Absolute Maximum Ratings</i> table from ± 4 V to ± 1.5 V.....	6
• Added continuous input current in <i>Absolute Maximum Ratings</i>	6
• Added <i>Electrical Characteristics: THS4021 (D Package)</i> section.....	8
• Changed small-signal bandwidth at $G = 10$, $V_{CC} = \pm 15$ V from 350 MHz to 290 MHz in <i>Electrical Characteristics: THS4021 (D Package)</i>	8
• Changed small-signal bandwidth at $G = 10$, $V_{CC} = \pm 5$ V from 280 MHz to 250 MHz in <i>Electrical Characteristics: THS4021 (D Package)</i>	8
• Changed small-signal bandwidth at $G = 20$, $V_{CC} = \pm 15$ V from 80 MHz to 110 MHz in <i>Electrical Characteristics: THS4021 (D Package)</i>	8
• Changed small-signal bandwidth at $G = 20$, $V_{CC} = \pm 5$ V from 70 MHz to 100 MHz in <i>Electrical Characteristics: THS4021 (D Package)</i>	8
• Changed full power bandwidth calculation from slew rate / $[2 \pi V_{O(Peak)}]$ to slew rate / $[\pi V_{O(P-P)}]$ in <i>Electrical Characteristics THS4021 (D Package)</i> table note.....	8
• Changed full power bandwidth in <i>Electrical Characteristics: THS4021 (D Package)</i> table from 3.7 MHz to 7.5 MHz to match calculation in footnote.....	8
• Changed full power bandwidth in <i>Electrical Characteristics: THS4021 (D Package)</i> table from 11.8 MHz to 23.6 MHz for $V_{CC} = \pm V$ to match calculation in footnote.....	8
• Changed slew rate condition in <i>Electrical Characteristics: THS4021 (D Package)</i> from a 10-V step to a 20-V step for $V_{CC} = \pm 15$ V.....	8

- Changed 0.1% settling time specification in *Electrical Characteristics: THS4021 (D Package)* from 40 ns to 30 ns for $V_{CC} = \pm 15\text{ V}$ 8
- Changed 0.1% settling time specification in *Electrical Characteristics: THS4021 (D Package)* from 50 ns to 30 ns for $V_{CC} = \pm 5\text{ V}$ 8
- Changed 0.01% settling time specification in *Electrical Characteristics: THS4021 (D Package)* from 145 ns to 160 ns for $V_{CC} = \pm 15\text{ V}$ 8
- Changed 0.01% settling time specification in *Electrical Characteristics: THS4021 (D Package)* from 155 ns to 160 sn for $V_{CC} = \pm 5\text{ V}$ 8
- Changed input current noise specification in *Electrical Characteristics: THS4021 (D Package)* from 1.5 pA/ $\sqrt{\text{Hz}}$ to 1.2 pA/ $\sqrt{\text{Hz}}$ 8
- Changed input current noise specification in *Electrical Characteristics: THS4021 (D Package)* from 1.2 pA/ $\sqrt{\text{Hz}}$ to 2.3 pA/ $\sqrt{\text{Hz}}$ 8
- Changed open-loop gain load condition in *Electrical Characteristics: THS4021 (D Package)* from 250 Ω to 1 k Ω for $V_{CC} = \pm 5\text{ V}$ 8
- Changed open-loop gain typical specification in *Electrical Characteristics: THS4021 (D Package)* from 60 mV/V to 100 dB for $V_{CC} = \pm 15\text{ V}$, $T_A = 25^\circ\text{C}$ 8
- Changed open-loop gain units from V/mV to dB in *Electrical Characteristics: THS4021 (D Package)* 8
- Changed open-loop gain typical specification in *Electrical Characteristics: THS4021 (D Package)* from 35 mV/V to 98 dB for $V_{CC} = \pm 5\text{ V}$, $T_A = 25^\circ\text{C}$ 8
- Changed input offset voltage typical specification in *Electrical Characteristics: THS4021 (D Package)* from 0.5 mA to 0.3 mA for 25°C 8
- Changed offset voltage drift typical specification in *Electrical Characteristics: THS4021 (D Package)* from 15 $\mu\text{A}/^\circ\text{C}$ to 2 $\mu\text{A}/^\circ\text{C}$ 8
- Changed input bias current typical in *Electrical Characteristics THS4021 (D Pacakge)* from 3 μA to 9 μA for $T_A = 25^\circ\text{C}$ 8
- Changed input bias current maximum value in *Electrical Characteristics THS4021 (D Package)* from 6 μA to 20 μA for $T_A = 25^\circ\text{C}$ 8
- Changed input bias current maximum value in *Electrical Characteristics THS4021 (D Package)* from 8 μA to 33 μA for $T_A = \text{full range}$ 8
- Changed input offset current drift typical value in *Electrical Characteristics: THS4021 (D Package)* from 0.3 nA/ $^\circ\text{C}$ to 0.2 nA/ $^\circ\text{C}$ 8
- Added Common-mode rejection ratio typical in *Electrical Characteristics: THS4021 (D Package)* for 25°C 8
- Added common-mode rejection ratio in *Electrical Characteristics: THS4021 (D Package)* for $V_{CC} = \pm 5\text{ V}$ 8
- Changed output voltage swing typical value in *Electrical Characteristics: THS4021 (D Package)* from $\pm 12.5\text{ V}$ to $\pm 12.9\text{ V}$ for $V_{CC} = \pm 15\text{ V}$, $R_L = 250\ \Omega$ 8
- Changed output voltage swing typical value in *Electrical Characteristics: THS4021 (D Package)* from $\pm 3.3\text{ V}$ to $\pm 3.5\text{ V}$ for $V_{CC} = \pm 5\text{ V}$, $R_L = 150\ \Omega$ 8
- Changed output voltage swing typical value in *Electrical Characteristics: THS4021 (D Package)* from $\pm 13.5\text{ V}$ to $\pm 13.6\text{ V}$ for $V_{CC} = \pm 15\text{ V}$, $R_L = 1\text{ k}\Omega$ 8
- Changed output current load resistance typical value in *Electrical Characteristics THS4021 (D Package)* from 20 Ω to 10 Ω 8
- Changed output current typical value in *Electrical Characteristics: THS4021 (D Package)* from 100 mA to 200 mA for $V_{CC} = \pm 15\text{ V}$ 8
- Changed output current typical value in *Electrical Characteristics: THS4021 (D Package)* from 75 mA to 160 mA for $V_{CC} = \pm 5\text{ V}$ 8
- Changed output resistance in *Electrical Characteristics: THS4021 (D Package)* from 13 Ω to 5 Ω 8
- Changed supply current (each amplifier) typical value in *Electrical Characteristics: THS4021 (D Package)* from 7.8 mA to 7.5 mA for $V_{CC} = \pm 5\text{ V}$ 8
- Changed supply current (each amplifier) typical value in *Electrical Characteristics: THS4021 (D Package)* from 6.7 mA to 6.5 mA for $V_{CC} = \pm 5\text{ V}$ 8
- Added power-supply rejection ratio typical value in *Electrical Characteristics: THS4021 (D Package)* 8
- Changed title of *Electrical Characteristics* to *Electrical Characteristics: THS4021 (D Package) and THS4022 (D and DGN Packages)* 10
- Added *Typical Characteristics: THS4021 (D Package)* section..... 12

• Changed title of <i>Typical Characteristics</i> to <i>Typical Characteristics: THS4021 (D Package) and THS4022 (D and DGN Packages)</i>	17
• Added <i>Detailed Description</i> section.....	22
• Deleted <i>Noise Calculation and Noise Figure</i> and <i>Offset Voltage</i> sections.....	22
• Changed device label from "THS402x" to "THS4021" in Figure 7-4	23
• Changed <i>Application Information</i> section to latest standard format.....	24
• Added <i>Power Supply Recommendations</i> section.....	25
• Changed title of <i>Circuit Layout Considerations</i> section to <i>Layout Guidelines</i> , updated content, and moved to <i>Layout</i> section.....	25
• Deleted thermal calculations and plots from <i>General PowerPAD™ Integrated Circuit Package Design Considerations</i>	26
• Deleted <i>Evaluation Board</i> section.....	26

5 Pin Configuration and Functions

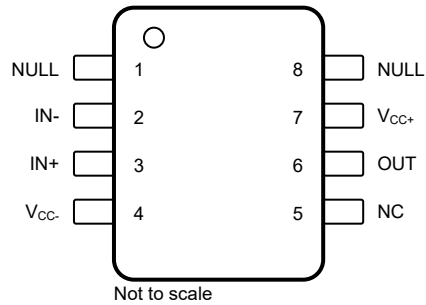

Figure 5-1. THS4021: D Package, 8-Pin SOIC, or DGN Package, 8-pin HVSSOP (Top View)

Table 5-1. Pin Functions: THS4021

PIN		TYPE	DESCRIPTION
NAME	NO.		
IN-	2	Input	Inverting input
IN+	3	Input	Noninverting input
NC	5	—	No connection
NULL	1, 8	Input	Voltage offset adjust
OUT	6	Output	Output of amplifier
V _{CC-}	4	—	Negative power supply
V _{CC+}	7	—	Positive power supply

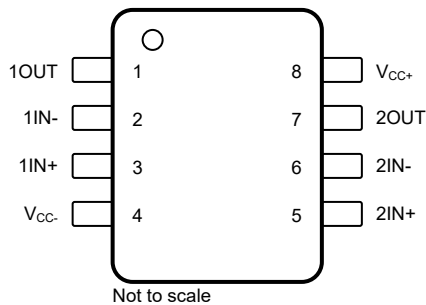

Figure 5-2. THS4022: D Package, 8-Pin SOIC, or DGN Package, 8-pin HVSSOP (Top View)

Table 5-2. Pin Functions: THS4022

PIN		TYPE	DESCRIPTION
NAME	NO.		
1IN-	2	Input	Channel 1 inverting input
1IN+	3	Input	Channel 1 noninverting input
1OUT	1	Output	Channel 1 output
2IN-	6	Input	Channel 2 inverting input
2IN+	5	Input	Channel 2 noninverting input
2OUT	7	Output	Channel 2 output
V _{CC-}	4	—	Negative power supply
V _{CC+}	8	—	Positive power supply

6 Specifications

6.1 Absolute Maximum Ratings

over operating free-air temperature range (unless otherwise noted)⁽¹⁾

		MIN	MAX	UNIT	
V _{CC-} to V _{CC+}	Supply voltage		33	V	
V _I	Input voltage		±V _{CC}	V	
I _O	Output current ⁽²⁾		240	mA	
V _{IO}	Differential input voltage		±1.5	V	
I _{IN}	Continuous input current		10	mA	
T _J	Maximum junction temperature		150	°C	
T _A	Operating free-air temperature	C-suffix	0	70	°C
		I-suffix	–40	85	
T _{stg}	Storage temperature	–65	150	°C	
	Lead temperature 1.6 mm (1/16 inch) from case for 10 seconds		300	°C	

- Operation outside the Absolute Maximum Ratings may cause permanent device damage. Absolute Maximum Ratings do not imply functional operation of the device at these or any other conditions beyond those listed under Recommended Operating Conditions. If used outside the Recommended Operating Conditions but within the Absolute Maximum Ratings, the device may not be fully functional, and this may affect device reliability, functionality, performance, and shorten the device lifetime.
- When continuously operating at any output current, do not exceed the maximum junction temperature. Keep the output current less than the absolute maximum rating regardless of time interval.

6.2 ESD Ratings

		VALUE	UNIT	
V _(ESD)	Electrostatic discharge	Human body model (HBM), per ANSI/ESDA/ JEDEC JS-001, all pins ⁽¹⁾	±1000	V
		Charged device model (CDM), per JEDEC specification JESD22-C101 ⁽²⁾	±1000	

- JEDEC document JEP155 states that 500-V HBM allows safe manufacturing with a standard ESD control process.
- JEDEC document JEP157 states that 250-V CDM allows safe manufacturing with a standard ESD control process.

6.3 Recommended Operating Conditions

over operating free-air temperature range (unless otherwise noted)

		MIN	NOM	MAX	UNIT	
V _{CC}	Supply voltage	Dual-supply	±4.5	±15	±16	V
		Single-supply	9	30	32	
T _A	Operating free-air temperature	C-suffix	0	25	70	°C
		I-suffix	–40	25	85	

6.4 Thermal Information: THS4021

THERMAL METRIC ⁽¹⁾		THS4021		UNIT
		D (SOIC)	DGN (HVSSOP)	
		8 PINS	8 PINS	
$R_{\theta JA}$	Junction-to-ambient thermal resistance	124.5	58.4	°C/W
$R_{\theta JC(top)}$	Junction-to-case (top) thermal resistance	65.0	4.7	°C/W
$R_{\theta JB}$	Junction-to-board thermal resistance	72.2	—	°C/W
Ψ_{JT}	Junction-to-top characterization parameter	13.6	—	°C/W
Ψ_{JB}	Junction-to-board characterization parameter	71.4	—	°C/W
$R_{\theta JC(bot)}$	Junction-to-case (bottom) thermal resistance	N/A	—	°C/W

(1) For more information about traditional and new thermal metrics, see the [Semiconductor and IC Package Thermal Metrics](#) application report.

6.5 Thermal Information: THS4022

THERMAL METRIC ⁽¹⁾		THS4022		UNIT
		D (SOIC)	DGN (HVSSOP)	
		8 PINS	8 PINS	
$R_{\theta JA}$	Junction-to-ambient thermal resistance	167	58.4	°C/W
$R_{\theta JC(top)}$	Junction-to-case (top) thermal resistance	38.3	4.7	°C/W
$R_{\theta JB}$	Junction-to-board thermal resistance	—	—	°C/W
Ψ_{JT}	Junction-to-top characterization parameter	—	—	°C/W
Ψ_{JB}	Junction-to-board characterization parameter	—	—	°C/W
$R_{\theta JC(bot)}$	Junction-to-case (bottom) thermal resistance	N/A	—	°C/W

(1) For more information about traditional and new thermal metrics, see the [Semiconductor and IC Package Thermal Metrics](#) application report.

6.6 Electrical Characteristics: THS4021 (D Package)

at $T_A = 25^\circ\text{C}$, $V_{CC} = \pm 15\text{ V}$, and $R_L = 150\ \Omega$ (unless otherwise noted)

PARAMETER		TEST CONDITIONS		MIN	TYP	MAX	UNIT
DYNAMIC PERFORMANCE							
BW	Small-signal bandwidth (–3 dB)	Gain = 10	$V_{CC} = \pm 15\text{ V}$		290		MHz
			$V_{CC} = \pm 5\text{ V}$		250		
		Gain = 20	$V_{CC} = \pm 15\text{ V}$		110		
			$V_{CC} = \pm 5\text{ V}$		100		
	Bandwidth for 0.1-dB flatness	Gain = 10	$V_{CC} = \pm 15\text{ V}$		17		
Full-power bandwidth ⁽¹⁾		$V_{O(pp)} = 20\text{ V}, V_{CC} = \pm 15\text{ V}$			7.5		
		$V_{O(pp)} = 5\text{ V}, V_{CC} = \pm 5\text{ V}$			23.6		
SR	Slew rate ⁽²⁾	Gain = 10	$V_{CC} = \pm 15\text{ V}, 20\text{-V step}$		470		V/ μs
			$V_{CC} = \pm 5\text{ V}, 5\text{-V step}$		370		
t_s	Settling time to 0.1%	Gain = –10	$V_{CC} = \pm 15\text{ V}, 5\text{-V step}$		30		ns
			$V_{CC} = \pm 5\text{ V}, 2\text{-V step}$		30		
	Settling time to 0.01%	Gain = –10	$V_{CC} = \pm 15\text{ V}, 5\text{-V step}$		160		
			$V_{CC} = \pm 5\text{ V}, 2\text{-V step}$		160		
NOISE/DISTORTION PERFORMANCE							
THD	Total harmonic distortion	$V_{O(pp)} = 2\text{ V}, f = 1\text{ MHz},$ gain = 10, $V_{CC} = \pm 15\text{ V}$	$R_L = 1\text{ k}\Omega$		–68		dBc
			$R_L = 1\text{ k}\Omega$		–77		
		$V_{O(pp)} = 2\text{ V}, f = 1\text{ MHz},$ gain = 10, $V_{CC} = \pm 5\text{ V}$	$R_L = 1\text{ k}\Omega$		–69		
			$R_L = 1\text{ k}\Omega$		–78		
V_n	Input voltage noise	$V_{CC} = \pm 5\text{ V}$ or $\pm 15\text{ V}, f > 10\text{ kHz}$			1.2		nV/ $\sqrt{\text{Hz}}$
I_n	Input current noise	$V_{CC} = \pm 5\text{ V}$ or $\pm 15\text{ V}, f > 10\text{ kHz}$			2.3		pA/ $\sqrt{\text{Hz}}$
	Differential gain error	Gain = 10, NTSC, 40 IRE modulation, ± 100 IRE ramp	$V_{CC} = \pm 15$		0.02		%
			$V_{CC} = \pm 5\text{ V}$		0.02		
	Differential phase error	Gain = 10, NTSC, 40 IRE modulation, ± 100 IRE ramp	$V_{CC} = \pm 15$		0.08		°
			$V_{CC} = \pm 5\text{ V}$		0.06		
DC PERFORMANCE							
	Open-loop gain	$V_{CC} = \pm 15\text{ V}, V_O = \pm 10\text{ V},$ $R_L = 1\text{ k}\Omega$	$T_A = 25^\circ\text{C}$	92	100		dB
			$T_A = \text{full range}$	91			
		$V_{CC} = \pm 5\text{ V}, V_O = \pm 2.5\text{ V},$ $R_L = 1\text{ k}\Omega$	$T_A = 25^\circ\text{C}$	86	98		
			$T_A = \text{full range}$	84			
V_{OS}	Input offset voltage	$V_{CC} = \pm 5\text{ V}$ or $\pm 15\text{ V}$	$T_A = 25^\circ\text{C}$		0.3	2	mV
			$T_A = \text{full range}$			3	
	Offset voltage drift	$V_{CC} = \pm 5\text{ V}$ or $\pm 15\text{ V}, T_A = \text{full range}$			2		$\mu\text{V}/^\circ\text{C}$
I_{IB}	Input bias current	$V_{CC} = \pm 5\text{ V}$ or $\pm 15\text{ V}$	$T_A = 25^\circ\text{C}$		9	20	μA
			$T_A = \text{full range}$			33	μA
I_{OS}	Input offset current	$V_{CC} = \pm 5\text{ V}$ or $\pm 15\text{ V}$	$T_A = 25^\circ\text{C}$		30	250	nA
			$T_A = \text{full range}$			400	nA
	Input offset current drift	$V_{CC} = \pm 5\text{ V}$ or $\pm 15\text{ V}, T_A = \text{full range}$			0.2		nA/ $^\circ\text{C}$

6.6 Electrical Characteristics: THS4021 (D Package) (continued)

at $T_A = 25^\circ\text{C}$, $V_{CC} = \pm 15\text{ V}$, and $R_L = 150\ \Omega$ (unless otherwise noted)

PARAMETER		TEST CONDITIONS		MIN	TYP	MAX	UNIT
INPUT CHARACTERISTICS							
V_{ICR}	Common-mode input voltage	$V_{CC} = \pm 15\text{ V}$		± 13.8	± 14.3		V
		$V_{CC} = \pm 5\text{ V}$		± 3.8	± 4.3		
$CMRR$	Common-mode rejection ratio	$V_{CC} = \pm 15\text{ V}$, $V_{ICR} = \pm 12\text{ V}$	$T_A = 25^\circ\text{C}$	95			dB
			$T_A = \text{full range}$	74			
		$V_{CC} = \pm 5\text{ V}$, $V_{ICR} = \pm 2.5\text{ V}$	$T_A = 25^\circ\text{C}$	100			
			$T_A = \text{full range}$	85			
r_i	Input resistance			1		M Ω	
C_i	Input capacitance			1.5		pF	
OUTPUT CHARACTERISTICS							
V_O	Output voltage swing	$V_{CC} = \pm 15\text{ V}$, $R_L = 250\ \Omega$		± 12	± 12.9		V
		$V_{CC} = \pm 5\text{ V}$, $R_L = 150\ \Omega$		± 3	± 3.5		
		$V_{CC} = \pm 15\text{ V}$, $R_L = 1\text{ k}\Omega$		± 13	± 13.6		
		$V_{CC} = \pm 5\text{ V}$, $R_L = 1\text{ k}\Omega$		± 3.4	± 3.8		
I_O	Output current	$V_{CC} = \pm 15\text{ V}$, $R_L = 10\ \Omega$		80	200		mA
		$V_{CC} = \pm 5\text{ V}$, $R_L = 10\ \Omega$		50	160		
R_O	Output resistance ⁽³⁾	Open-loop		5			Ω
POWER SUPPLY							
V_{CC}	Supply voltage	Dual supply		± 4.5		± 16.5	V
		Single supply		9		33	
I_{CC}	Supply current (per amplifier)	$V_{CC} = \pm 15\text{ V}$	$T_A = 25^\circ\text{C}$	7.5		10	mA
			$T_A = \text{full range}$			11	
		$V_{CC} = \pm 5\text{ V}$	$T_A = 25^\circ\text{C}$	6.5		9	
			$T_A = \text{full range}$			10.5	
$PSRR$	Power-supply rejection ratio	$V_{CC} = \pm 5\text{ V}$ or $\pm 15\text{ V}$		$T_A = 25^\circ\text{C}$	95		dB
				$T_A = \text{full range}$	80		

(1) Full-power bandwidth = slew rate / [$\pi V_{O(P-P)}$].

(2) Slew rate is measured from an output level range of 25% to 75%.

(3) Keep junction temperature less than the absolute maximum rating when the output is heavily loaded or shorted; see also [Section 6.1](#).

6.7 Electrical Characteristics: THS4021 (DGN Package) and THS4022 (D and DGN Packages)

at $T_A = 25^\circ\text{C}$, $V_{CC} = \pm 15\text{ V}$, $R_L = 150\ \Omega$ (unless otherwise noted)

PARAMETER		TEST CONDITIONS		MIN	TYP	MAX	UNIT	
DYNAMIC PERFORMANCE								
BW	Small-signal bandwidth (-3 dB)	Gain = 10	$V_{CC} = \pm 15\text{ V}$		350		MHz	
			$V_{CC} = \pm 5\text{ V}$		280			
		Gain = 20	$V_{CC} = \pm 15\text{ V}$		80			
			$V_{CC} = \pm 5\text{ V}$		70			
	Bandwidth for 0.1-dB flatness	Gain = 10	$V_{CC} = \pm 15\text{ V}$		17			
Full-power bandwidth ⁽¹⁾	$V_{O(pp)} = 20\text{ V}$, $V_{CC} = \pm 15\text{ V}$				3.7			
	$V_{O(pp)} = 5\text{ V}$, $V_{CC} = \pm 5\text{ V}$				11.8			
SR	Slew rate ⁽²⁾	Gain = 10	$V_{CC} = \pm 15\text{ V}$, 10-V step		470		V/ μs	
			$V_{CC} = \pm 5\text{ V}$, 5-V step		370			
t_s	Settling time to 0.1%	Gain = -10	$V_{CC} = \pm 15\text{ V}$, 5-V step		40		ns	
			$V_{CC} = \pm 5\text{ V}$, 2-V step		50			
	Settling time to 0.01%	Gain = -10	$V_{CC} = \pm 15\text{ V}$, 5-V step		145			
			$V_{CC} = \pm 5\text{ V}$, 2-V step		150			
NOISE/DISTORTION PERFORMANCE								
THD	Total harmonic distortion	$V_{O(pp)} = 2\text{ V}$, $f = 1\text{ MHz}$, gain = 2, $V_{CC} = \pm 15\text{ V}$	$R_L = 1\text{ k}\Omega$		-68		dBc	
			$R_L = 1\text{ k}\Omega$		-77			
		$V_{O(pp)} = 2\text{ V}$, $f = 1\text{ MHz}$, gain = 2, $V_{CC} = \pm 5\text{ V}$	$R_L = 1\text{ k}\Omega$		-69			
			$R_L = 1\text{ k}\Omega$		-78			
V_n	Input voltage noise	$V_{CC} = \pm 5\text{ V}$ or $\pm 15\text{ V}$, $f > 10\text{ kHz}$			1.5		nV/ $\sqrt{\text{Hz}}$	
	Differential gain error	Gain = 2, NTSC, 40 IRE modulation, ± 100 IRE ramp	$V_{CC} = \pm 15$		0.02		%	
			$V_{CC} = \pm 5\text{ V}$		0.02			
	Differential phase error	Gain = 2, NTSC, 40 IRE modulation, ± 100 IRE ramp	$V_{CC} = \pm 15$		0.08		°	
			$V_{CC} = \pm 5\text{ V}$		0.06			
X_T	Channel-to-channel crosstalk (THS4022 only)	$V_{CC} = \pm 5\text{ V}$ or $\pm 15\text{ V}$, $f = 1\text{ MHz}$			-60		dB	
DC PERFORMANCE								
	Open-loop gain	$V_{CC} = \pm 15\text{ V}$, $V_O = \pm 10\text{ V}$, $R_L = 1\text{ k}\Omega$	$T_A = 25^\circ\text{C}$	40	60		V/mV	
			$T_A = \text{full range}$	35				
			$V_{CC} = \pm 5\text{ V}$, $V_O = \pm 2.5\text{ V}$, $R_L = 250\ \Omega$	$T_A = 25^\circ\text{C}$	20	35		
			$T_A = \text{full range}$	15				
V_{OS}	Input offset voltage	$V_{CC} = \pm 5\text{ V}$ or $\pm 15\text{ V}$	$T_A = 25^\circ\text{C}$		0.5	2	mV	
			$T_A = \text{full range}$			3		
	Offset voltage drift	$V_{CC} = \pm 5\text{ V}$ or $\pm 15\text{ V}$	$T_A = \text{full range}$		15		$\mu\text{V}/^\circ\text{C}$	
I_{IB}	Input bias current	$V_{CC} = \pm 5\text{ V}$ or $\pm 15\text{ V}$	$T_A = 25^\circ\text{C}$		3	6	μA	
			$T_A = \text{full range}$			6		
I_{OS}	Input offset current	$V_{CC} = \pm 5\text{ V}$ or $\pm 15\text{ V}$	$T_A = 25^\circ\text{C}$		30	250	nA	
			$T_A = \text{full range}$			400		
	Input offset current drift	$T_A = \text{full range}$			0.3		nA/ $^\circ\text{C}$	

6.7 Electrical Characteristics: THS4021 (DGN Package) and THS4022 (D and DGN Packages) (continued)

at $T_A = 25^\circ\text{C}$, $V_{CC} = \pm 15\text{ V}$, $R_L = 150\ \Omega$ (unless otherwise noted)

PARAMETER		TEST CONDITIONS		MIN	TYP	MAX	UNIT
INPUT CHARACTERISTICS							
V_{ICR}	Common-mode input voltage	$V_{CC} = \pm 15\text{ V}$		± 13.8	± 14.3		V
		$V_{CC} = \pm 5\text{ V}$		± 3.8	± 4.3		
CMRR	Common-mode rejection ratio	$V_{CC} = \pm 15\text{ V}$, $V_{ICR} = \pm 12\text{ V}$, $T_A = \text{full range}$		74	95		dB
r_i	Input resistance				1		M Ω
C_i	Input capacitance				1.5		pF
OUTPUT CHARACTERISTICS							
V_O	Output voltage swing	$V_{CC} = \pm 15\text{ V}$, $R_L = 250\ \Omega$		± 12	± 12.5		V
		$V_{CC} = \pm 5\text{ V}$, $R_L = 150\ \Omega$		± 3	± 3.3		
		$V_{CC} = \pm 15\text{ V}$, $R_L = 150\ \Omega$		± 13	± 13.5		
		$V_{CC} = \pm 5\text{ V}$, $R_L = 150\ \Omega$		± 3.4	± 3.8		
I_O	Output current	$R_L = 20\ \Omega$	$V_{CC} = \pm 15\text{ V}$	80	100		mA
			$V_{CC} = \pm 5\text{ V}$	50	75		
I_{SC}	Short-circuit current ⁽³⁾	$V_{CC} = \pm 15\text{ V}$			150		mA
R_O	Output resistance ⁽³⁾	Open loop			13		Ω
POWER SUPPLY							
V_{CC}	Supply voltage	Dual supply		± 4.5		± 16.5	V
		Single supply		9		33	
I_{CC}	Supply current (per amplifier)	$V_{CC} = \pm 15\text{ V}$	$T_A = 25^\circ\text{C}$		7.8	10	mA
			$T_A = \text{full range}$			11	
		$V_{CC} = \pm 5\text{ V}$	$T_A = 25^\circ\text{C}$		6.7	9	
			$T_A = \text{full range}$			10.5	
PSRR	Power-supply rejection ratio	$V_{CC} = \pm 5\text{ V}$ or $\pm 15\text{ V}$, $T_A = \text{full range}$		80	95		dB

(1) Full-power bandwidth = slew rate / $2\pi V_{O(\text{Peak})}$.

(2) Slew rate is measured from an output level range of 25% to 75%.

(3) Keep junction temperature less than the absolute maximum rating when the output is heavily loaded or shorted; see also [Section 6.1](#).

6.8 Typical Characteristics: THS4021 (D Package)

at $T_A = 25^\circ\text{C}$, $V_{CC} = \pm 5\text{ V}$, gain = +10 V/V, $R_L = 150\ \Omega$, and $R_F = 220\ \Omega$ (unless otherwise noted)

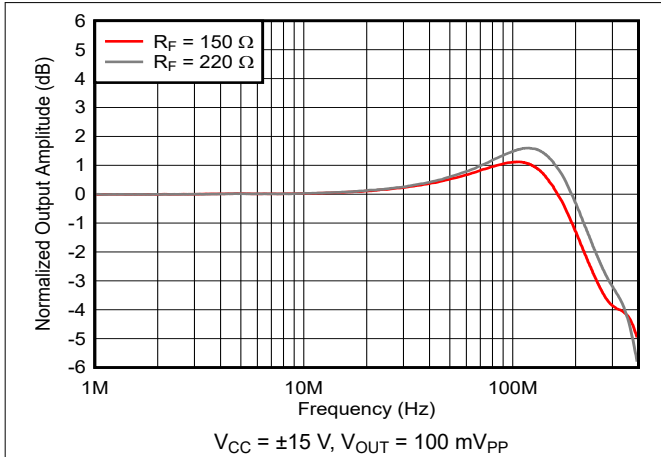

Figure 6-1. Frequency Response vs Feedback Resistance

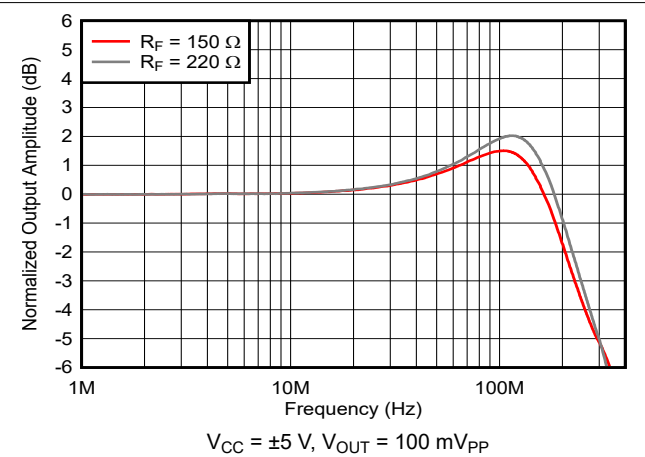

Figure 6-2. Frequency Response vs Feedback Resistance

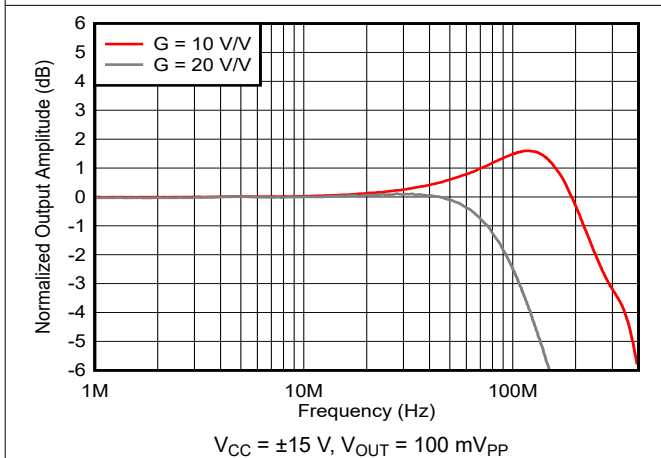

Figure 6-3. Frequency Response vs Gain

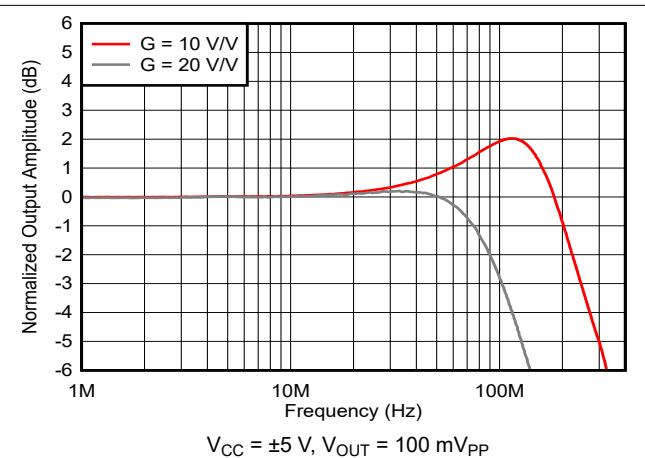

Figure 6-4. Frequency Response vs Gain

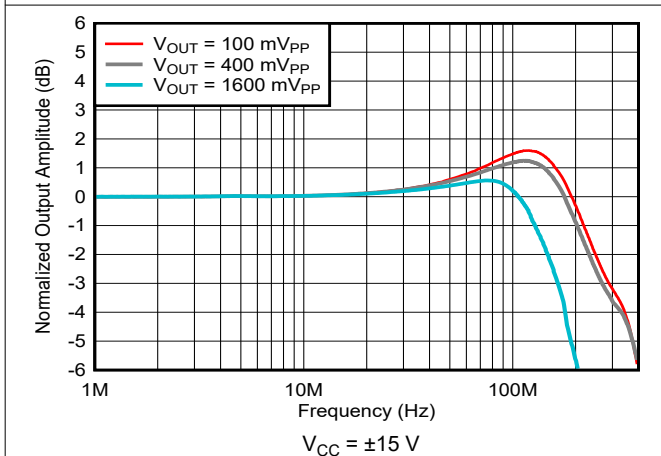

Figure 6-5. Large-Signal Frequency Response

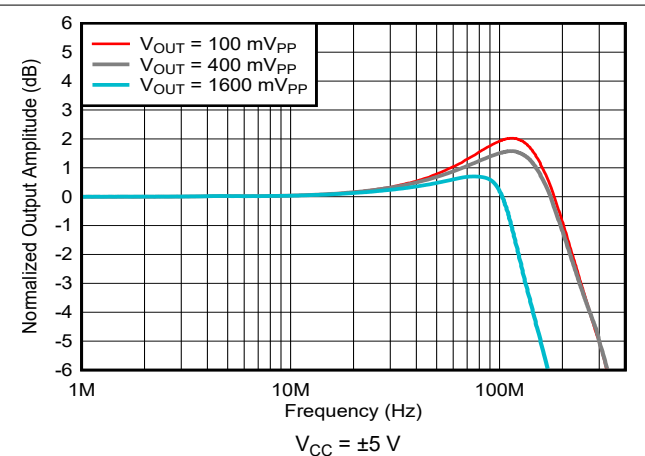

Figure 6-6. Large-Signal Frequency Response

6.8 Typical Characteristics: THS4021 (D Package) (continued)

at $T_A = 25^\circ\text{C}$, $V_{CC} = \pm 5\text{ V}$, gain = +10 V/V, $R_L = 150\ \Omega$, and $R_F = 220\ \Omega$ (unless otherwise noted)

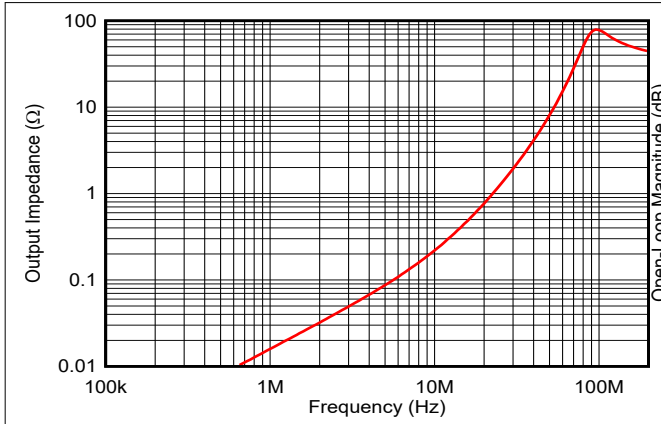

Figure 6-7. Closed-Loop Output Impedance

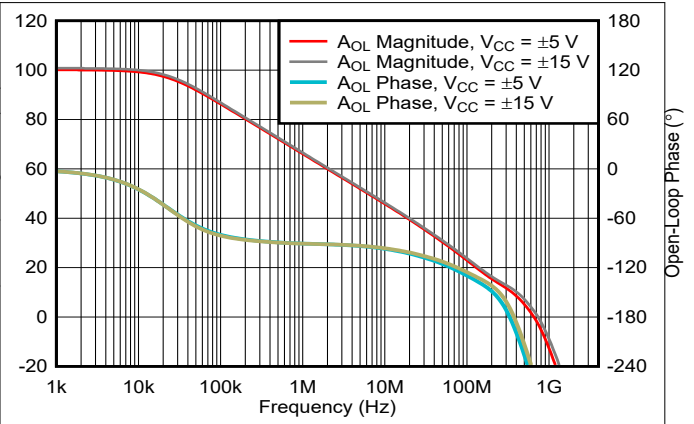

Figure 6-8. Open-loop Gain and Phase Response

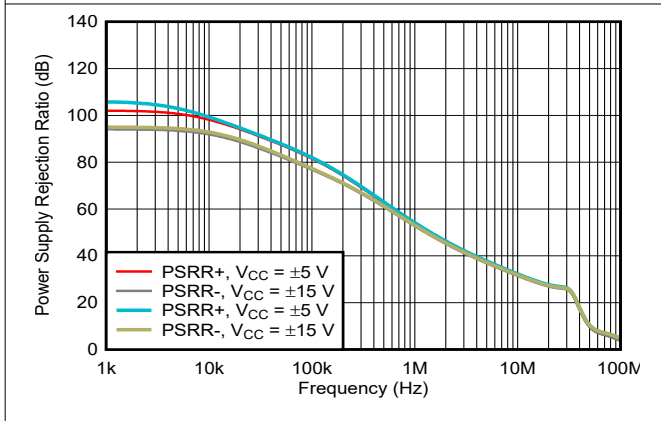

Figure 6-9. Power-Supply Rejection Ratio vs Frequency

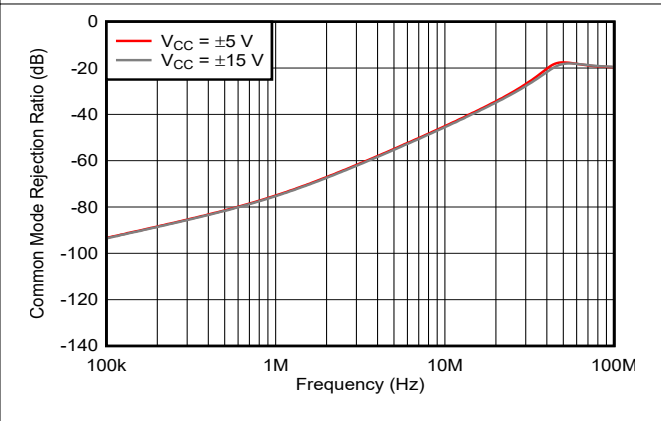

Figure 6-10. Common-Mode Rejection Ratio vs Frequency

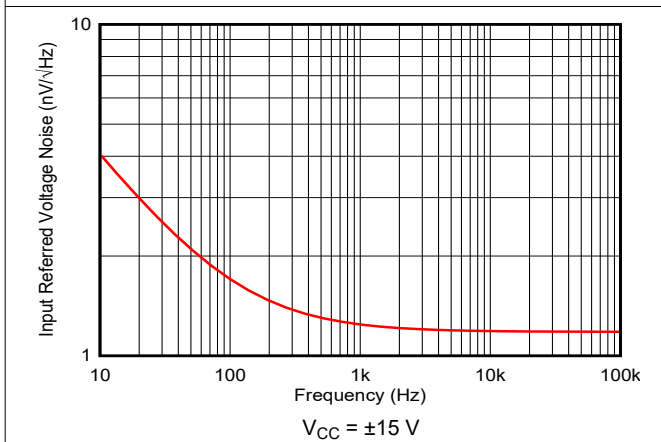

Figure 6-11. Input-Referred Voltage Noise vs Frequency

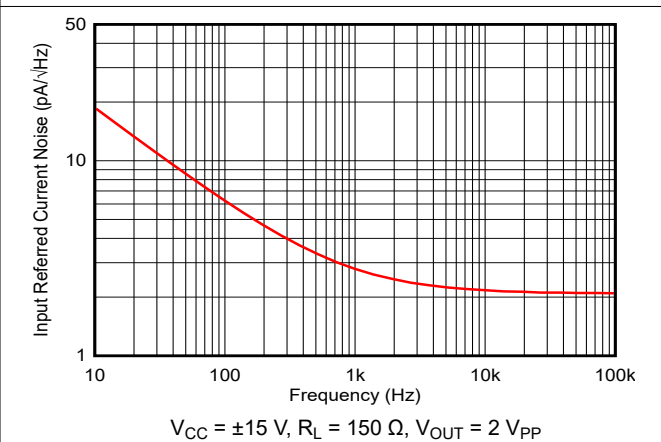
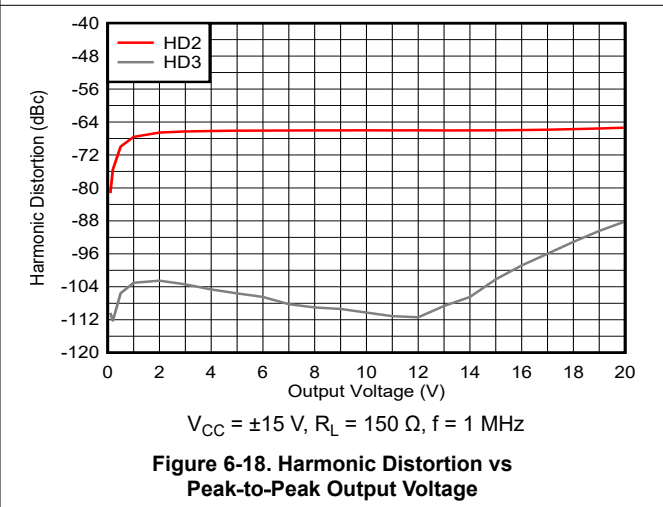
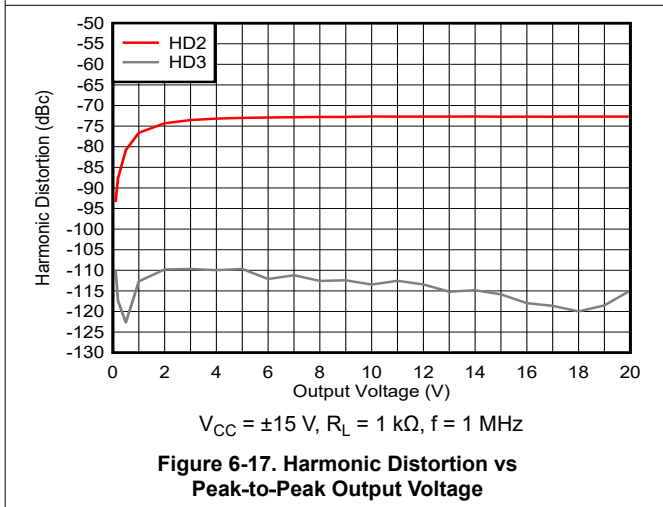
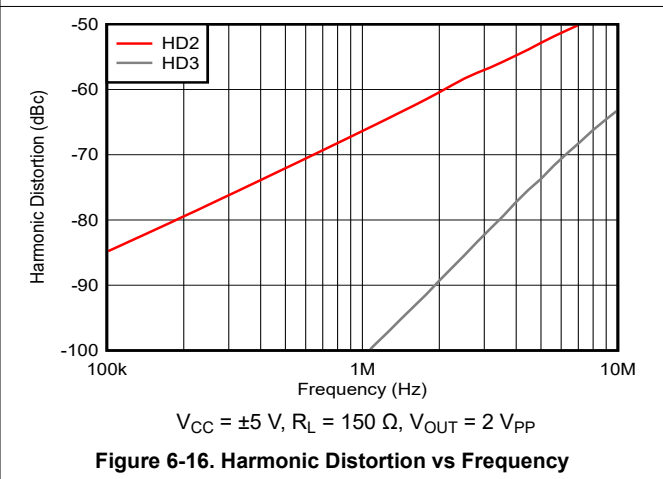
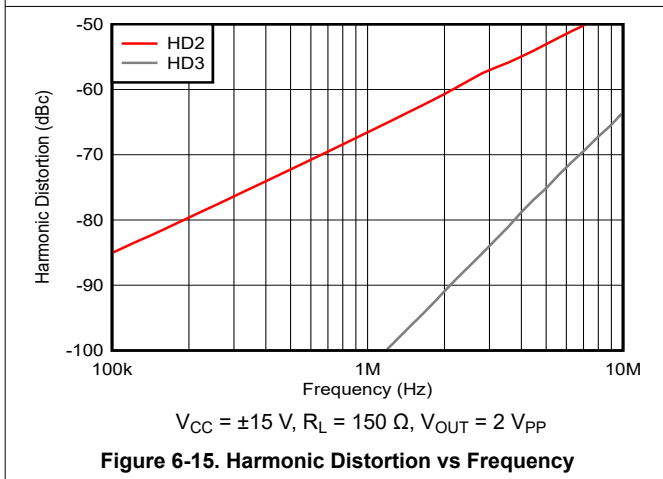
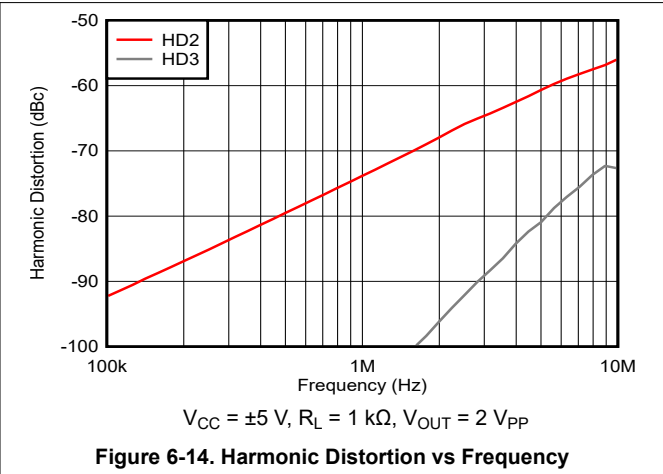
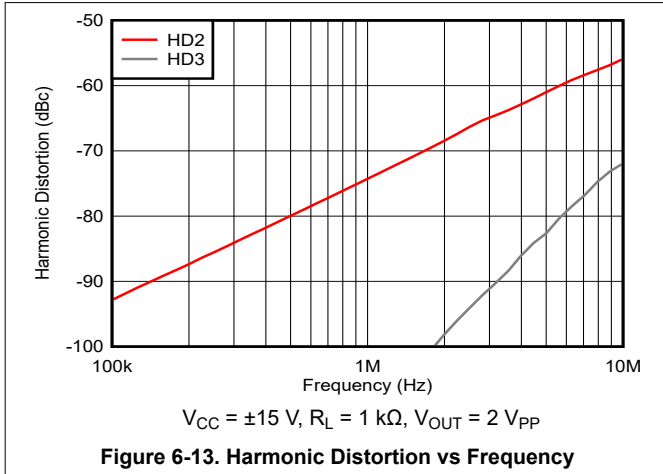

Figure 6-12. Input-Referred Current Noise vs Frequency

6.8 Typical Characteristics: THS4021 (D Package) (continued)

at $T_A = 25^\circ\text{C}$, $V_{CC} = \pm 5\text{ V}$, gain = +10 V/V, $R_L = 150\ \Omega$, and $R_F = 220\ \Omega$ (unless otherwise noted)



6.8 Typical Characteristics: THS4021 (D Package) (continued)

at $T_A = 25^\circ\text{C}$, $V_{CC} = \pm 5\text{ V}$, gain = +10 V/V, $R_L = 150\ \Omega$, and $R_F = 220\ \Omega$ (unless otherwise noted)

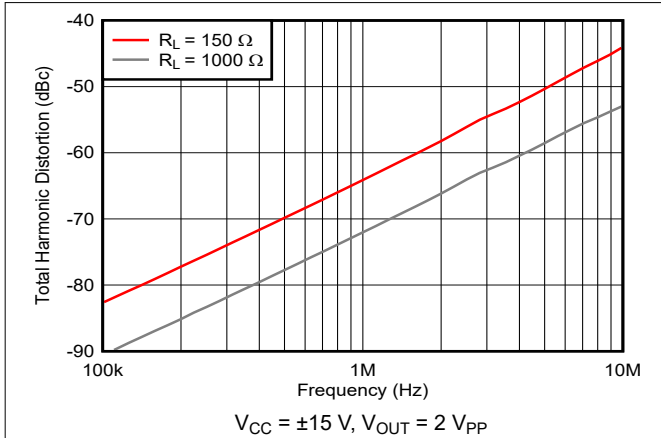

Figure 6-19. Total Harmonic Distortion vs Frequency

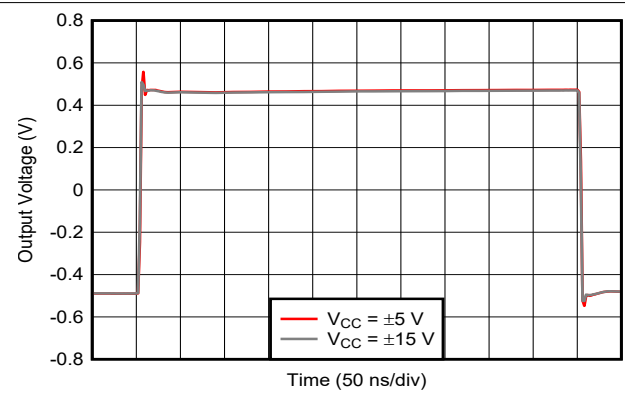

Figure 6-20. 1-V Step Response

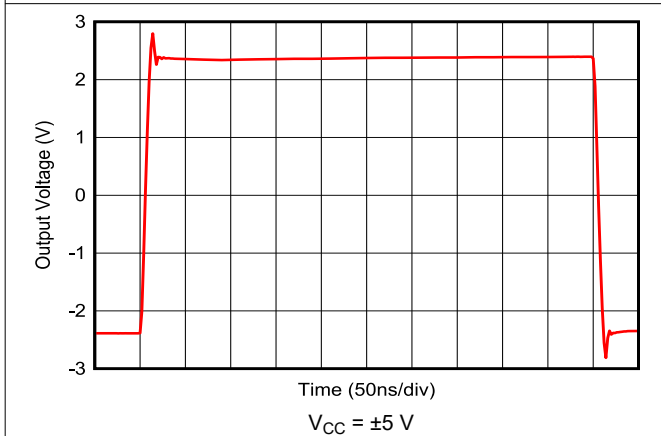

Figure 6-21. 5-V Step Response

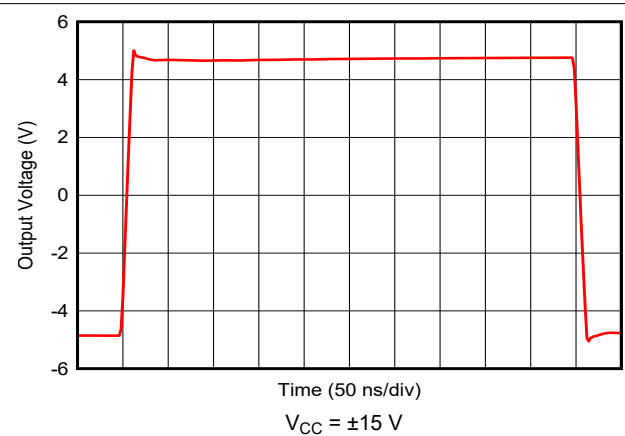

Figure 6-22. 10-V Step Response

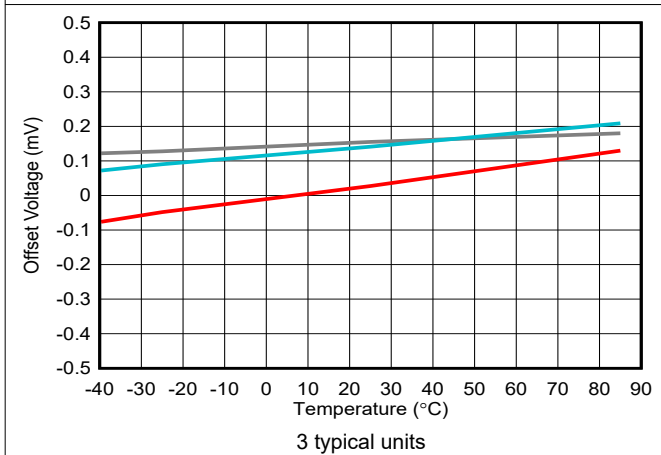

Figure 6-23. Input Offset Voltage vs Ambient Temperature

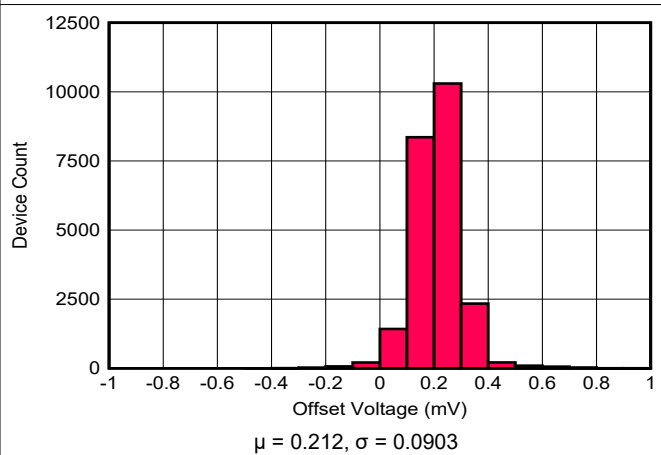

Figure 6-24. Voltage Offset Distribution

6.8 Typical Characteristics: THS4021 (D Package) (continued)

at $T_A = 25^\circ\text{C}$, $V_{CC} = \pm 5\text{ V}$, gain = +10 V/V, $R_L = 150\ \Omega$, and $R_F = 220\ \Omega$ (unless otherwise noted)

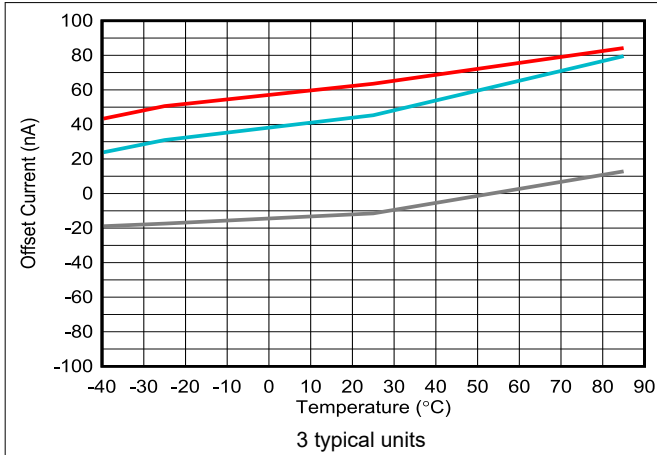

Figure 6-25. Input Offset Current vs Ambient Temperature

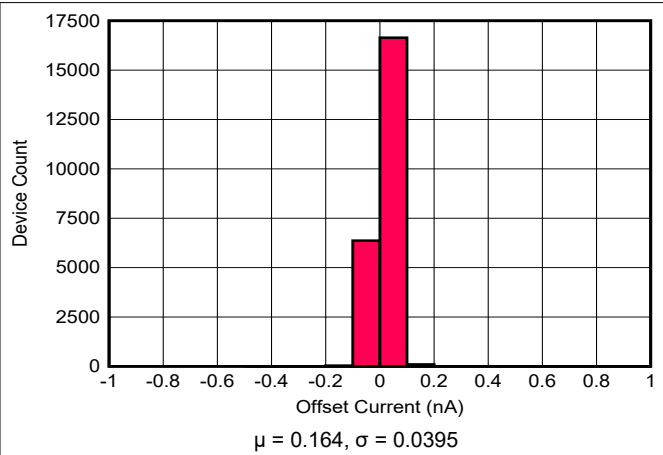

Figure 6-26. Input Offset Current vs Ambient Temperature

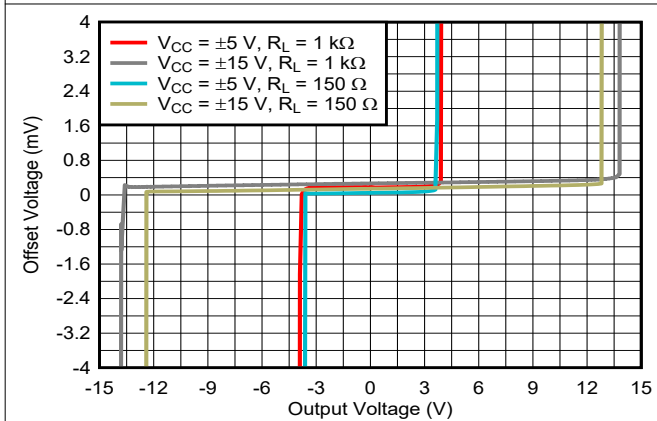

Figure 6-27. Offset Voltage vs Output Voltage

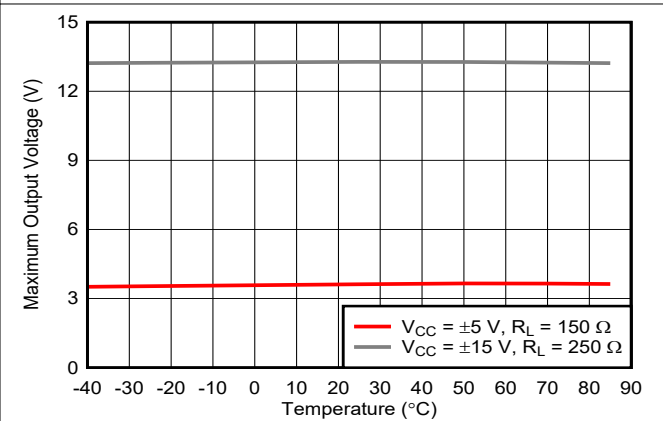

Figure 6-28. Maximum Output Voltage Swing vs Ambient Temperature

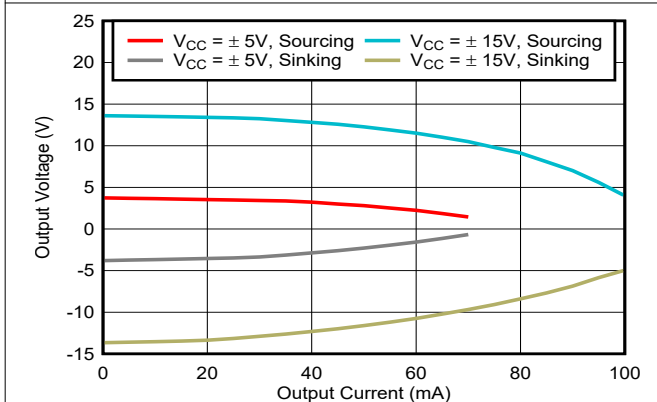

Figure 6-29. Output Swing vs Load Current

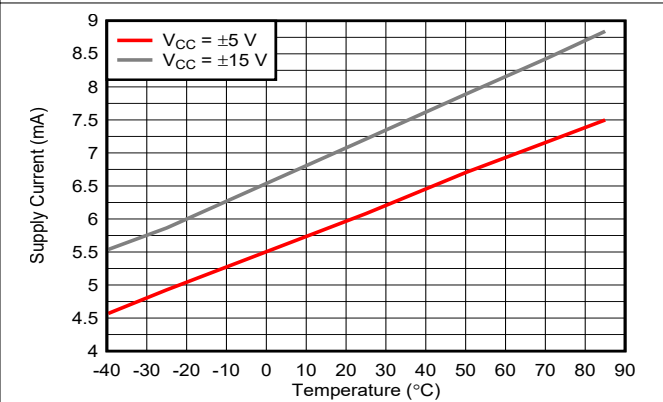

Figure 6-30. Supply Current vs Ambient Temperature

6.9 Typical Characteristics: THS4021 (DGN Package) and THS4022 (D and DGN Packages)

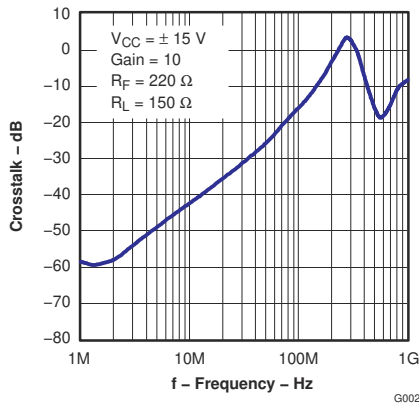

Figure 6-31. Crosstalk vs Frequency

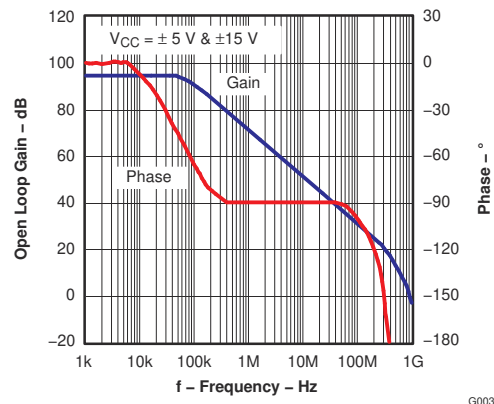

Figure 6-32. Open Loop Gain and Phase Response vs Frequency

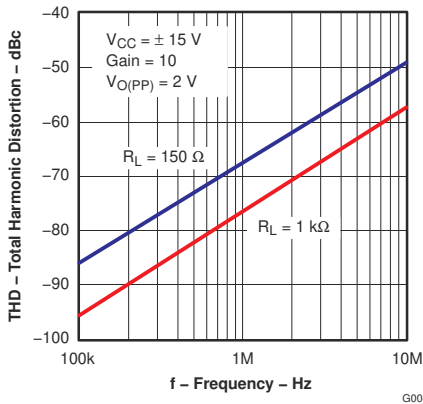

Figure 6-33. Total Harmonic Distortion vs Frequency

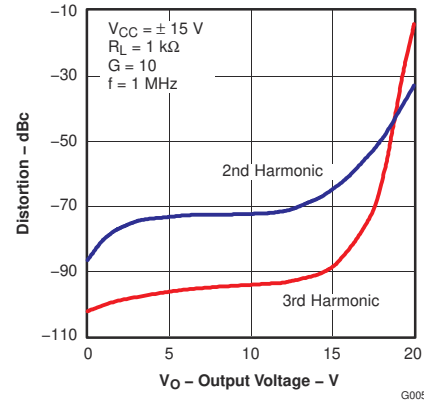

Figure 6-34. Distortion vs Output Voltage

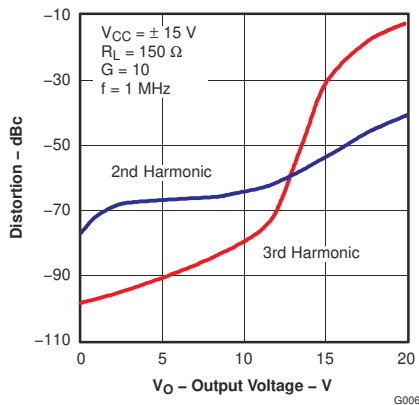

Figure 6-35. Distortion vs Output Voltage

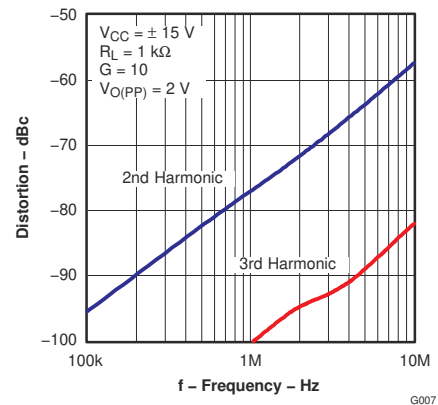

Figure 6-36. Distortion vs Frequency

6.9 Typical Characteristics: THS4021 (DGN Package) and THS4022 (D and DGN Packages) (continued)

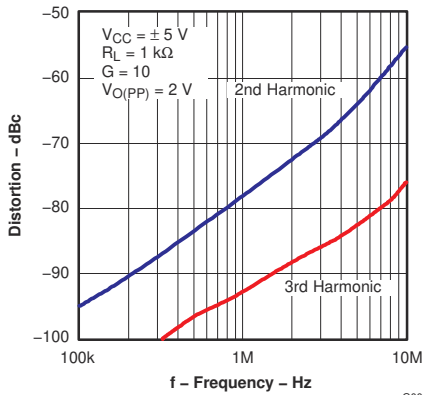

Figure 6-37. Distortion vs Frequency

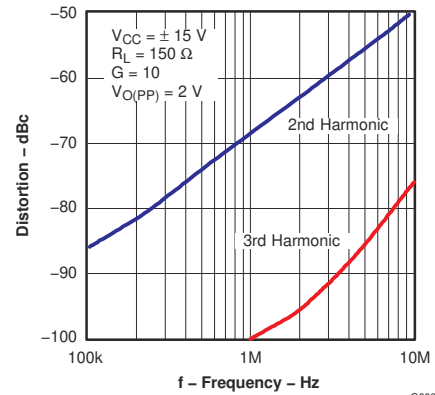

Figure 6-38. Distortion vs Frequency

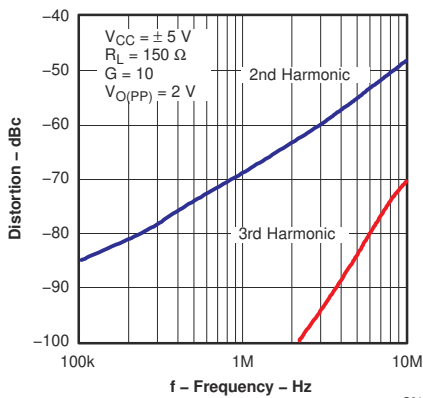

Figure 6-39. Distortion vs Frequency

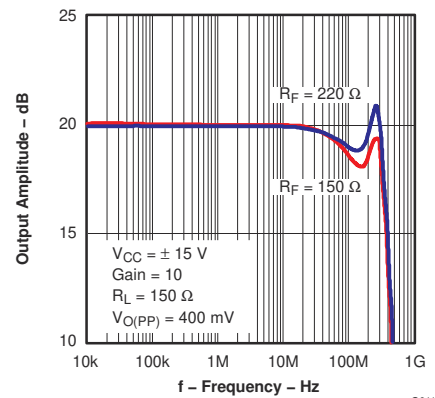

Figure 6-40. Output Amplitude vs Frequency

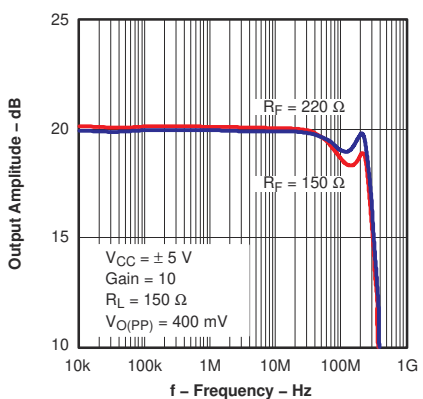

Figure 6-41. Output Amplitude vs Frequency

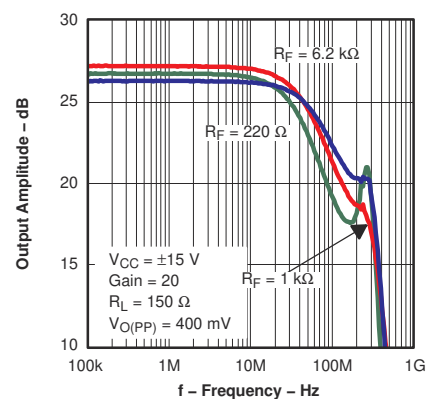

Figure 6-42. Output Amplitude vs Frequency

6.9 Typical Characteristics: THS4021 (DGN Package) and THS4022 (D and DGN Packages) (continued)

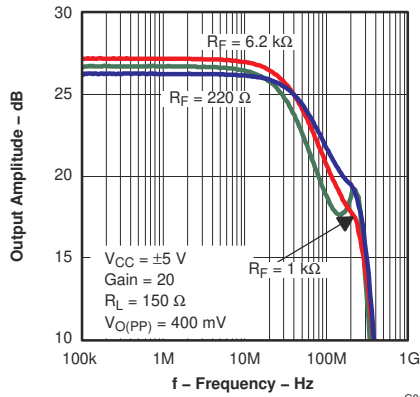

Figure 6-43. Output Amplitude vs Frequency

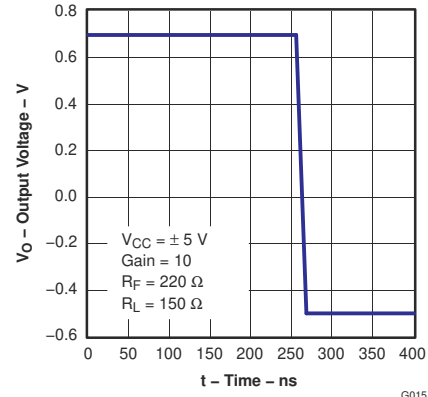

Figure 6-44. 1-V Step Response

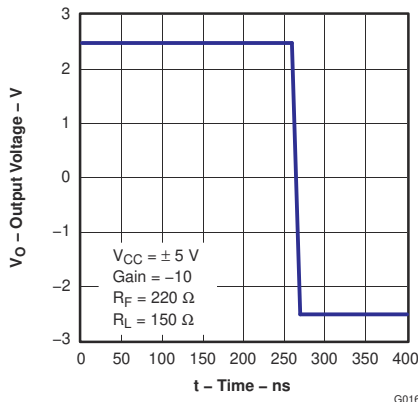

Figure 6-45. 5-V Step Response

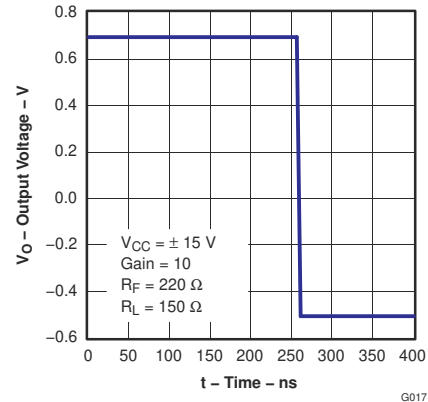

Figure 6-46. 1-V Step Response

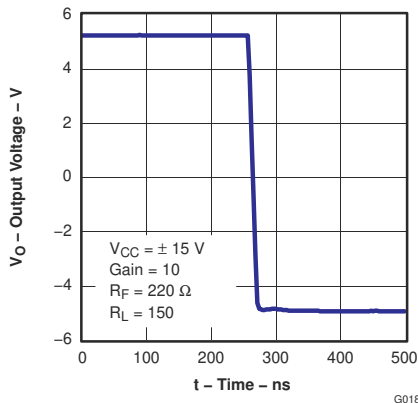

Figure 6-47. 10-V Step Response

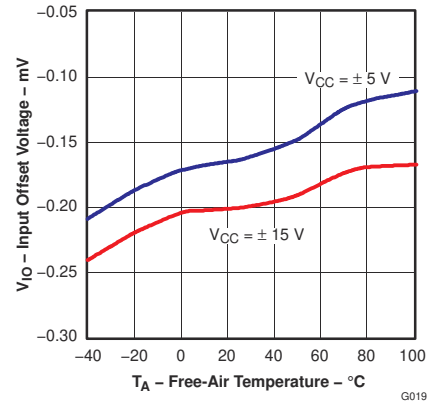

Figure 6-48. Input Offset Voltage vs Free-air Temperature

6.9 Typical Characteristics: THS4021 (DGN Package) and THS4022 (D and DGN Packages) (continued)

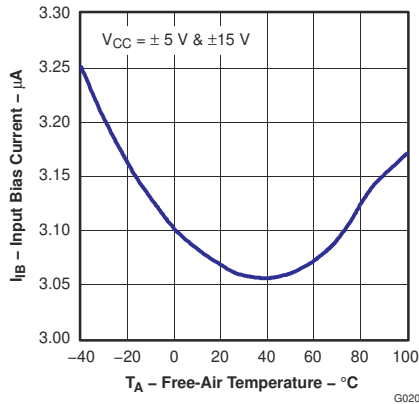

Figure 6-49. Input Bias Current vs Free-air Temperature

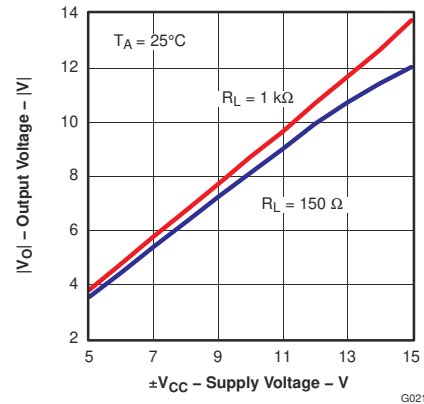

Figure 6-50. Output Voltage vs Supply Voltage

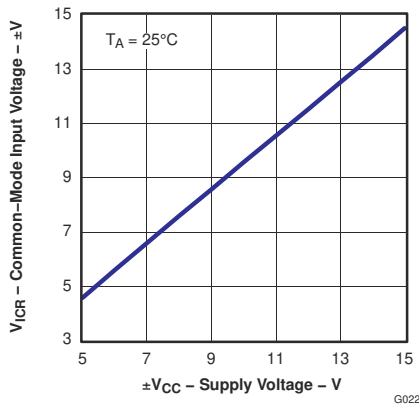

Figure 6-51. Common-mode Input Voltage vs Supply Voltage

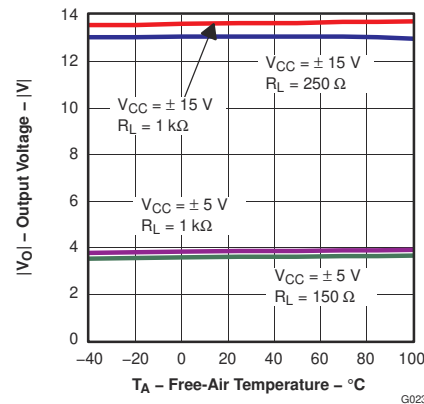

Figure 6-52. Output Voltage vs Free-air Temperature

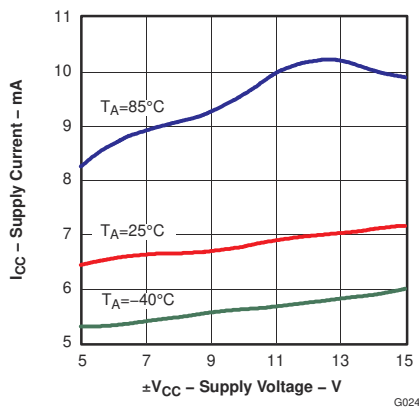

Figure 6-53. Supply Current vs Supply Voltage

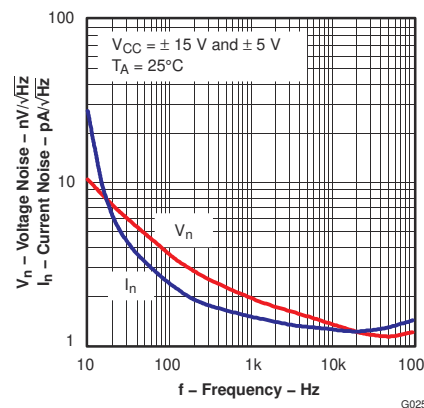

Figure 6-54. Voltage and Current Noise vs Frequency

6.9 Typical Characteristics: THS4021 (DGN Package) and THS4022 (D and DGN Packages) (continued)

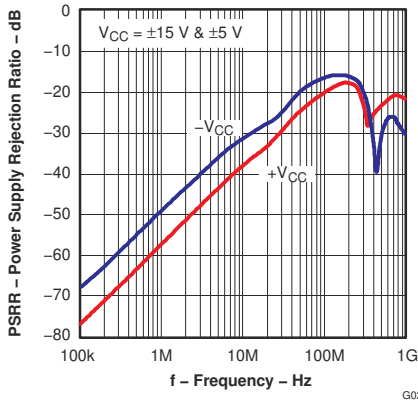

Figure 6-55. Power Supply Rejection Ratio vs Frequency

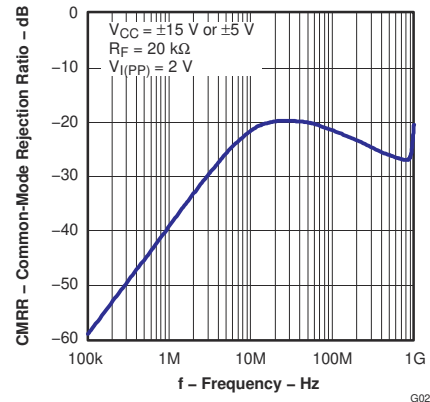

Figure 6-56. Common Mode Rejection Ratio vs Frequency

7 Detailed Description

7.1 Overview

The THS402x are high-speed operational amplifiers configured in a decompensated voltage-feedback architecture. The THS402x are stable with gain configurations of 10 V/V or greater. These amplifiers is built using a greater than 30-V, complementary, bipolar process with NPN and PNP transistors possessing an f_T of several GHz. This configuration results in exceptionally high-performance amplifiers with wide bandwidth, high slew rate, fast settling time, and low distortion.

7.2 Functional Block Diagram

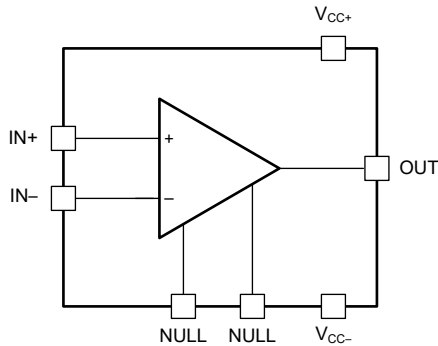

Figure 7-1. THS4021: Single Channel

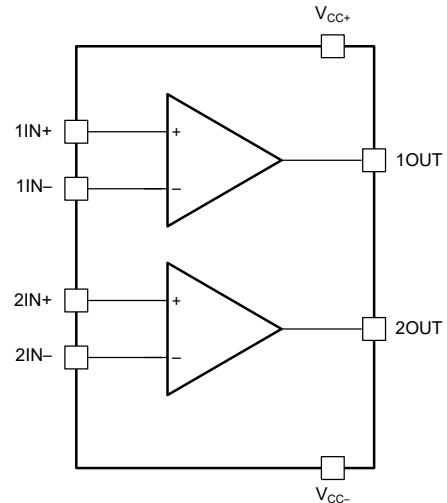

Figure 7-2. THS4022: Dual Channel

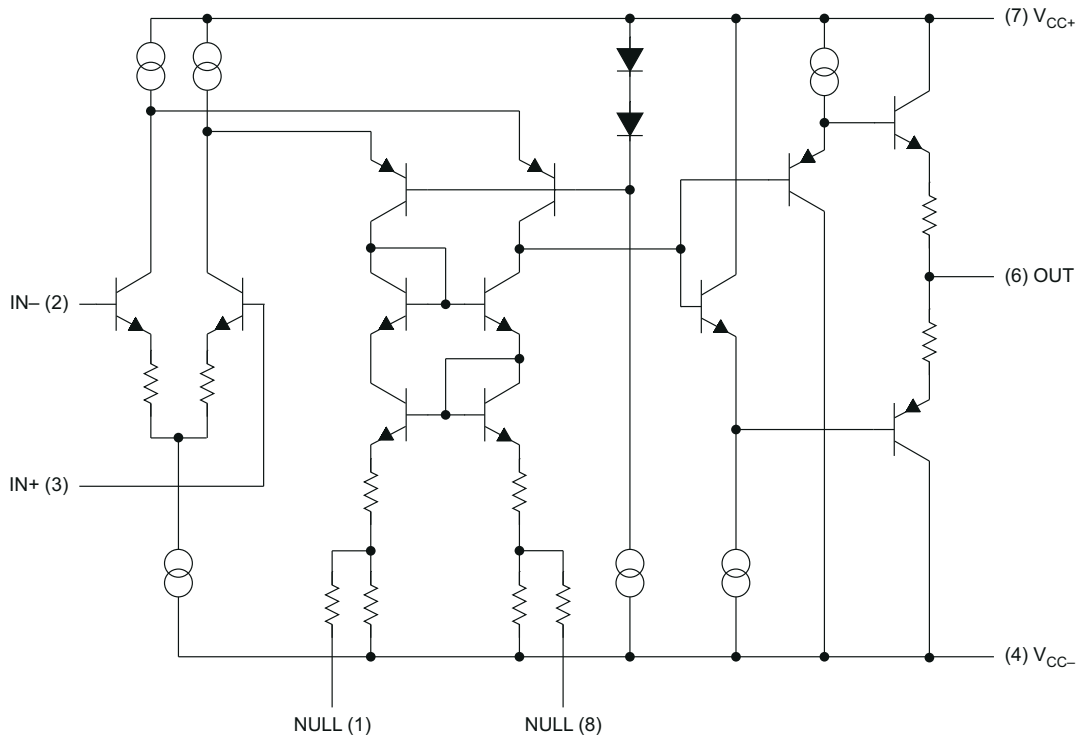

Figure 7-3. THS4021 Simplified Schematic

S0276-01

7.3 Feature Description

7.3.1 Offset Nulling

The THS402x have a very low input offset voltage for high-speed amplifiers. However, if additional correction is required, an offset nulling function has been provided on the THS4021. To adjust the input offset voltage, place a potentiometer between pin 1 and pin 8 of the device, and tie the wiper to the negative supply. [Figure 7-4](#) shows this feature.

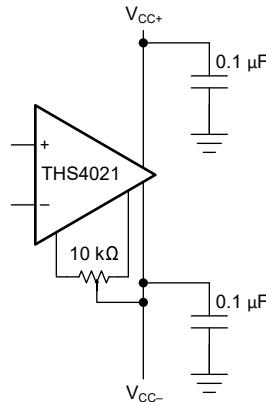

Figure 7-4. Offset Nulling Schematic

7.4 Device Functional Modes

The THS402x family has a single functional mode and can be used with both single-supply or split power-supply configurations. The power-supply voltage must be greater than 9 V (± 4.5 V) and less than 33 V (± 16.5 V).

8 Application and Implementation

Note

Information in the following applications sections is not part of the TI component specification, and TI does not warrant its accuracy or completeness. TI's customers are responsible for determining suitability of components for their purposes, as well as validating and testing their design implementation to confirm system functionality.

8.1 Application Information

8.1.1 Driving a Capacitive Load

The THS402x are internally compensated to maximize bandwidth and slew-rate performance. To maintain stability, take additional precautions when driving capacitive loads with a high-performance amplifier. As a result of the internal compensation, significant capacitive loading directly on the output node decreases the device phase margin, and potentially lead to high-frequency ringing or oscillations. Therefore, for capacitive loads greater than 10 pF, place an isolation resistor in series with the output of the amplifier. Figure 8-1 shows this configuration. For most applications, a minimum resistance of 20 Ω is recommended. In 75-Ω transmission systems, setting the series resistor value to 75 Ω is a beneficial choice because this value isolates any capacitance loading and provides source impedance matching.

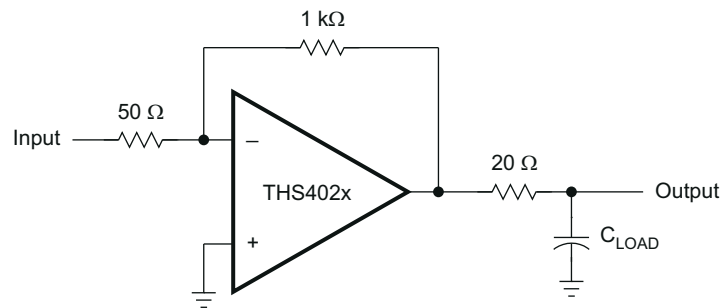

S0278-01

Figure 8-1. Driving a Capacitive Load

8.1.2 General Configuration

When receiving low-level signals, limiting the bandwidth of the incoming signals into the system is often required. Figure 8-2 shows how the simplest way to accomplish this limiting is to place an RC filter at the noninverting pin of the amplifier.

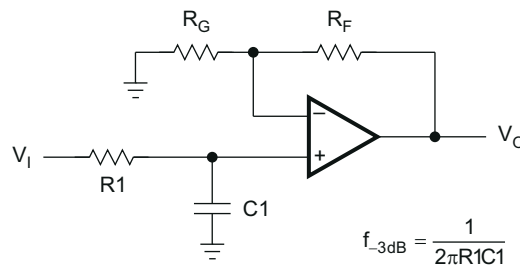

$$f_{-3dB} = \frac{1}{2\pi R_1 C_1}$$

$$\frac{V_O}{V_I} = \left(1 + \frac{R_F}{R_G}\right) \left(\frac{1}{1 + sR_1 C_1}\right)$$

S0281-01

Figure 8-2. Single-Pole Low-Pass Filter

8.2 Power Supply Recommendations

The THS402x devices are designed to operate on power supplies ranging from ± 4.5 V to ± 16 V (single-ended supplies of 9 V to 32 V). Use a power-supply accuracy of 5% or better. When operated on a board with high-speed digital signals, make sure to provide isolation between digital signal noise and the analog input pins. The THS4021 and THS4022 are connected to the positive power supply (V_{CC+}) through pin 7 and pin 8, respectively. Both devices use pin 4 for the negative power supply (V_{CC-}). Decouple each supply pin to GND as close to the device as possible.

8.3 Layout

8.3.1 Layout Guidelines

To achieve the levels of high-frequency performance of the THS402x, follow proper printed-circuit board (PCB), high-frequency design techniques. The following is a general set of guidelines. In addition, a THS402x evaluation board is available to use as a guide for layout or for evaluating the device performance.

- **Ground planes**—make sure that the ground plane used on the board provides all components with a low-inductive ground connection. However, in the areas of the amplifier inputs and output, the ground plane can be removed to minimize stray capacitance.
- **Proper power-supply decoupling**—use a 6.8- μ F tantalum capacitor in parallel with a 0.1- μ F ceramic capacitor on each supply pin. Sharing the tantalum capacitor among several amplifiers is possible depending on the application, but always use a 0.1- μ F ceramic capacitor on the supply pin of every amplifier. In addition, place the 0.1- μ F capacitor as close as possible to the supply pin. As this distance increases, the inductance in the connecting trace makes the capacitor less effective. Strive for distances of less than 0.1 inch (2.54 mm) between the device power pins and the ceramic capacitors.
- **Short trace runs or compact part placements**—optimum high-frequency performance is achieved when stray series inductance has been minimized. To realize this, make the circuit layout as compact as possible, thereby minimizing the length of all trace runs. Pay particular attention to the inputs of the amplifier, keeping the trace lengths as short as possible. This layout helps to minimize stray capacitance at the input of the amplifier.

8.3.1.1 General PowerPAD™ Integrated Circuit Package Design Considerations

The THS402x is available in a thermally-enhanced DGN package, which is a member of the PowerPAD™ integrated circuit package family. Figure 8-3 a and Figure 8-3 b show that this package is constructed using a downset leadframe upon which the die is mounted. Figure 8-3 c that this arrangement results in the leadframe being exposed as a thermal pad on the underside of the package. Because this thermal pad has direct thermal contact with the die, excellent thermal performance can be achieved by providing a good thermal path away from the thermal pad.

The PowerPAD integrated circuit package allows for both assembly and thermal management in one manufacturing operation. During the surface-mount solder operation (when the leads are being soldered), the thermal pad can also be soldered to a copper area underneath the package. Through the use of thermal paths within this copper area, heat can be conducted away from the package into either a ground plane or other heat dissipating device.

The PowerPAD integrated circuit package represents a breakthrough in combining the small area and ease of assembly of the surface mount with the previously awkward mechanical methods of heat sinking.

More complete details of the PowerPAD installation process and thermal management techniques are found in [PowerPAD Thermally-Enhanced Package](#). This document is found on the TI website (www.ti.com) by searching on the keyword PowerPAD. The document can also be ordered through your local TI sales office; refer to SLMA002 when ordering.

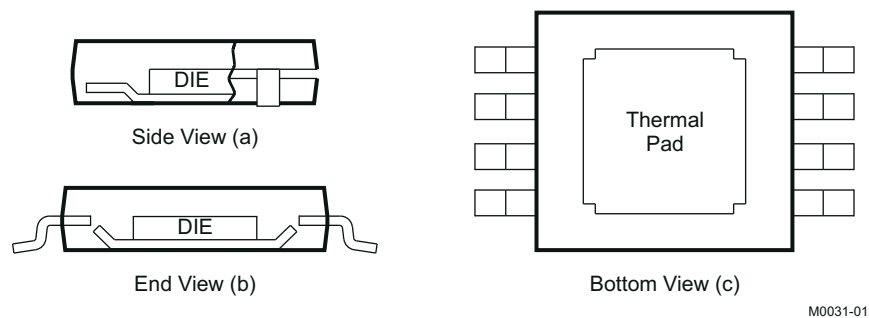

NOTE: The thermal pad (PowerPAD integrated circuit package) is electrically isolated from all other pins and can be connected to any potential from V_{CC-} to V_{CC+} . Typically, the thermal pad is connected to the ground plane because this plane tends to physically be the largest and is able to dissipate the most amount of heat.

Figure 8-3. Views of Thermally-enhanced DGN Package

8.3.2 Layout Example

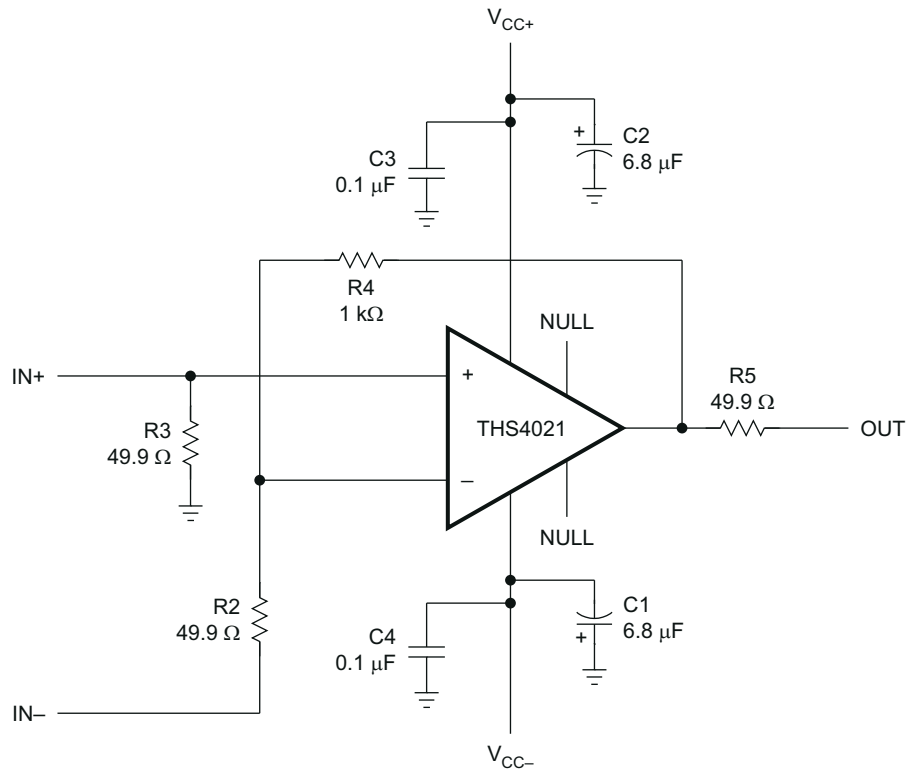

S0282-01

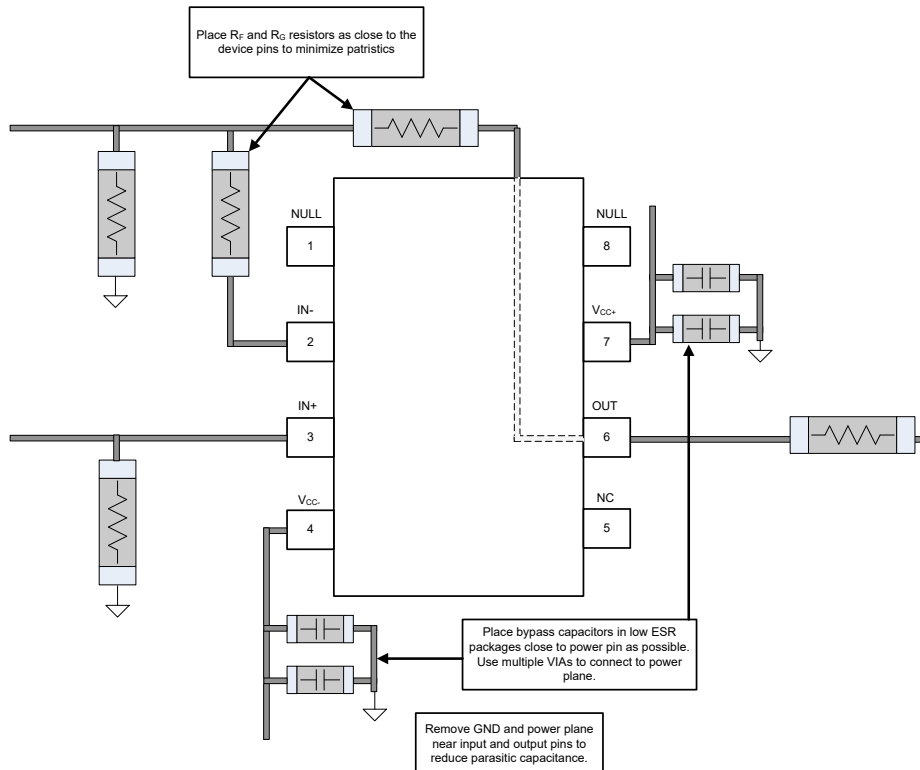

Figure 8-4. Layout Recommendations

9 Device and Documentation Support

TI offers an extensive line of development tools. Tools and software to evaluate the performance of the device, generate code, and develop solutions are listed below.

9.1 Documentation Support

9.1.1 Related Documentation

For related documentation, see the following:

- Texas Instruments, [Noise Analysis in Operational Amplifier Circuits](#) application report
- Texas Instruments, [PowerPAD Thermally Enhanced Package](#) application report
- Texas Instruments, [THS4021 High-Speed Operational Amplifier Evaluation Module](#) user's guide
- Texas Instruments, [THS4022 Dual High-Speed Operational Amplifier Evaluation Module](#) user's guide

9.2 Receiving Notification of Documentation Updates

To receive notification of documentation updates, navigate to the device product folder on ti.com. Click on *Subscribe to updates* to register and receive a weekly digest of any product information that has changed. For change details, review the revision history included in any revised document.

9.3 Support Resources

TI E2E™ [support forums](#) are an engineer's go-to source for fast, verified answers and design help — straight from the experts. Search existing answers or ask your own question to get the quick design help you need.

Linked content is provided "AS IS" by the respective contributors. They do not constitute TI specifications and do not necessarily reflect TI's views; see TI's [Terms of Use](#).

9.4 Trademarks

PowerPAD™ and TI E2E™ are trademarks of Texas Instruments.

All trademarks are the property of their respective owners.

9.5 Electrostatic Discharge Caution



This integrated circuit can be damaged by ESD. Texas Instruments recommends that all integrated circuits be handled with appropriate precautions. Failure to observe proper handling and installation procedures can cause damage.

ESD damage can range from subtle performance degradation to complete device failure. Precision integrated circuits may be more susceptible to damage because very small parametric changes could cause the device not to meet its published specifications.

9.6 Glossary

[TI Glossary](#) This glossary lists and explains terms, acronyms, and definitions.

10 Mechanical, Packaging, and Orderable Information

The following pages include mechanical, packaging, and orderable information. This information is the most current data available for the designated devices. This data is subject to change without notice and revision of this document. For browser-based versions of this data sheet, refer to the left-hand navigation.

PACKAGING INFORMATION

Orderable Device	Status (1)	Package Type	Package Drawing	Pins	Package Qty	Eco Plan (2)	Lead finish/ Ball material (6)	MSL Peak Temp (3)	Op Temp (°C)	Device Marking (4/5)	Samples
THS4021CDGN	ACTIVE	HVSSOP	DGN	8	80	RoHS & Green	NIPDAU	Level-1-260C-UNLIM	0 to 70	ACK	Samples
THS4021CDGNR	ACTIVE	HVSSOP	DGN	8	2500	RoHS & Green	NIPDAU	Level-1-260C-UNLIM	0 to 70	ACK	Samples
THS4021IDGN	ACTIVE	HVSSOP	DGN	8	80	RoHS & Green	NIPDAU	Level-1-260C-UNLIM	-40 to 85	ACL	Samples
THS4021IDGNR	ACTIVE	HVSSOP	DGN	8	2500	RoHS & Green	NIPDAU	Level-1-260C-UNLIM	-40 to 85	ACL	Samples
THS4021IDR	ACTIVE	SOIC	D	8	2500	RoHS & Green	NIPDAU	Level-1-260C-UNLIM	-40 to 85	4021I	Samples
THS4022CD	LIFEBUY	SOIC	D	8	75	RoHS & Green	NIPDAU	Level-1-260C-UNLIM	0 to 70	4022C	
THS4022ID	LIFEBUY	SOIC	D	8	75	RoHS & Green	NIPDAU	Level-1-260C-UNLIM	-40 to 85	4022I	
THS4022IDGNR	ACTIVE	HVSSOP	DGN	8	2500	RoHS & Green	Call TI NIPDAU	Level-1-260C-UNLIM	-40 to 85	ACB	Samples

(1) The marketing status values are defined as follows:

ACTIVE: Product device recommended for new designs.

LIFEBUY: TI has announced that the device will be discontinued, and a lifetime-buy period is in effect.

NRND: Not recommended for new designs. Device is in production to support existing customers, but TI does not recommend using this part in a new design.

PREVIEW: Device has been announced but is not in production. Samples may or may not be available.

OBSELETE: TI has discontinued the production of the device.

(2) **RoHS:** TI defines "RoHS" to mean semiconductor products that are compliant with the current EU RoHS requirements for all 10 RoHS substances, including the requirement that RoHS substance do not exceed 0.1% by weight in homogeneous materials. Where designed to be soldered at high temperatures, "RoHS" products are suitable for use in specified lead-free processes. TI may reference these types of products as "Pb-Free".

RoHS Exempt: TI defines "RoHS Exempt" to mean products that contain lead but are compliant with EU RoHS pursuant to a specific EU RoHS exemption.

Green: TI defines "Green" to mean the content of Chlorine (Cl) and Bromine (Br) based flame retardants meet JS709B low halogen requirements of <=1000ppm threshold. Antimony trioxide based flame retardants must also meet the <=1000ppm threshold requirement.

(3) MSL, Peak Temp. - The Moisture Sensitivity Level rating according to the JEDEC industry standard classifications, and peak solder temperature.

(4) There may be additional marking, which relates to the logo, the lot trace code information, or the environmental category on the device.

(5) Multiple Device Markings will be inside parentheses. Only one Device Marking contained in parentheses and separated by a "-" will appear on a device. If a line is indented then it is a continuation of the previous line and the two combined represent the entire Device Marking for that device.

⁽⁶⁾ Lead finish/Ball material - Orderable Devices may have multiple material finish options. Finish options are separated by a vertical ruled line. Lead finish/Ball material values may wrap to two lines if the finish value exceeds the maximum column width.

Important Information and Disclaimer:The information provided on this page represents TI's knowledge and belief as of the date that it is provided. TI bases its knowledge and belief on information provided by third parties, and makes no representation or warranty as to the accuracy of such information. Efforts are underway to better integrate information from third parties. TI has taken and continues to take reasonable steps to provide representative and accurate information but may not have conducted destructive testing or chemical analysis on incoming materials and chemicals. TI and TI suppliers consider certain information to be proprietary, and thus CAS numbers and other limited information may not be available for release.

In no event shall TI's liability arising out of such information exceed the total purchase price of the TI part(s) at issue in this document sold by TI to Customer on an annual basis.

TAPE AND REEL INFORMATION

QUADRANT ASSIGNMENTS FOR PIN 1 ORIENTATION IN TAPE



*All dimensions are nominal

Device	Package Type	Package Drawing	Pins	SPQ	Reel Diameter (mm)	Reel Width W1 (mm)	A0 (mm)	B0 (mm)	K0 (mm)	P1 (mm)	W (mm)	Pin1 Quadrant
THS4021CDGNR	HVSSOP	DGN	8	2500	330.0	12.4	5.3	3.4	1.4	8.0	12.0	Q1
THS4021IDGNR	HVSSOP	DGN	8	2500	330.0	12.4	5.3	3.4	1.4	8.0	12.0	Q1
THS4021IDR	SOIC	D	8	2500	330.0	12.4	6.4	5.2	2.1	8.0	12.0	Q1

TAPE AND REEL BOX DIMENSIONS

*All dimensions are nominal

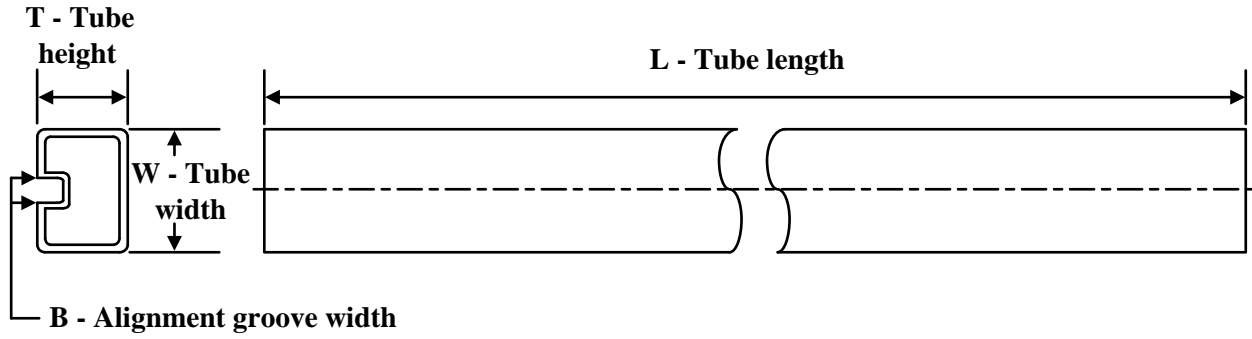
Device	Package Type	Package Drawing	Pins	SPQ	Length (mm)	Width (mm)	Height (mm)
THS4021CDGNR	HVSSOP	DGN	8	2500	358.0	335.0	35.0
THS4021IDGNR	HVSSOP	DGN	8	2500	358.0	335.0	35.0
THS4021IDR	SOIC	D	8	2500	350.0	350.0	43.0

TUBE

*All dimensions are nominal

Device	Package Name	Package Type	Pins	SPQ	L (mm)	W (mm)	T (μm)	B (mm)
THS4022CD	D	SOIC	8	75	505.46	6.76	3810	4
THS4022ID	D	SOIC	8	75	505.46	6.76	3810	4

GENERIC PACKAGE VIEW

DGN 8

PowerPAD VSSOP - 1.1 mm max height

3 x 3, 0.65 mm pitch

SMALL OUTLINE PACKAGE

This image is a representation of the package family, actual package may vary.
Refer to the product data sheet for package details.

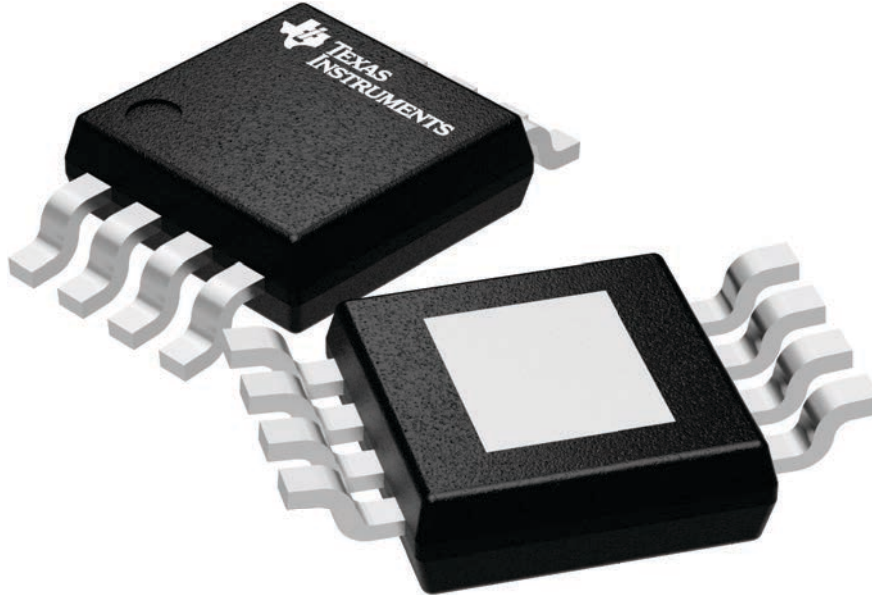

4225482/A

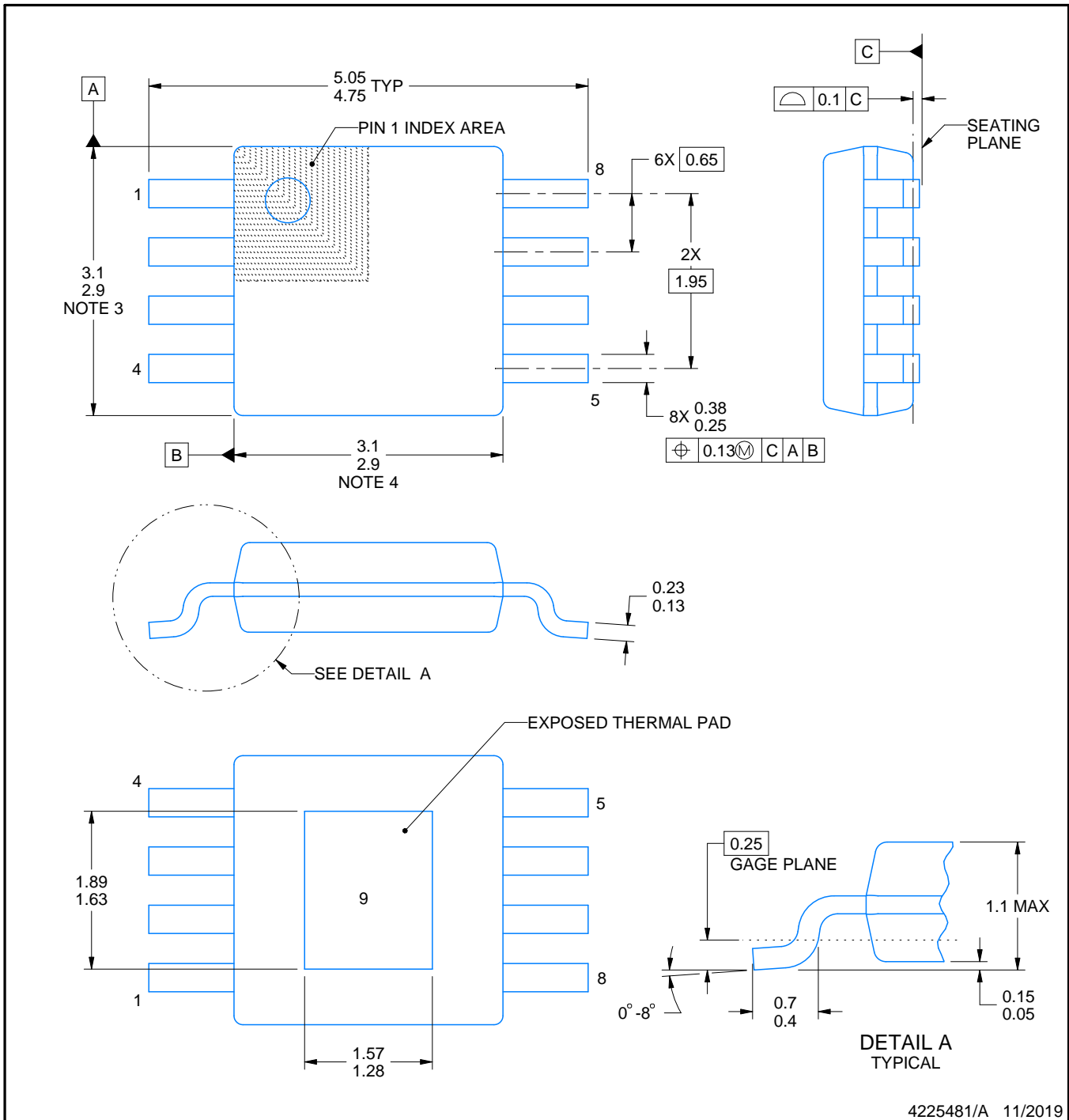
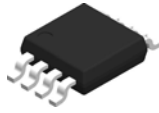

4225481/A 11/2019

NOTES:

PowerPAD is a trademark of Texas Instruments.

1. All linear dimensions are in millimeters. Any dimensions in parenthesis are for reference only. Dimensioning and tolerancing per ASME Y14.5M.
2. This drawing is subject to change without notice.
3. This dimension does not include mold flash, protrusions, or gate burrs. Mold flash, protrusions, or gate burrs shall not exceed 0.15 mm per side.
4. This dimension does not include interlead flash. Interlead flash shall not exceed 0.25 mm per side.
5. Reference JEDEC registration MO-187.

EXAMPLE BOARD LAYOUT

DGN0008D

PowerPAD™ VSSOP - 1.1 mm max height

SMALL OUTLINE PACKAGE

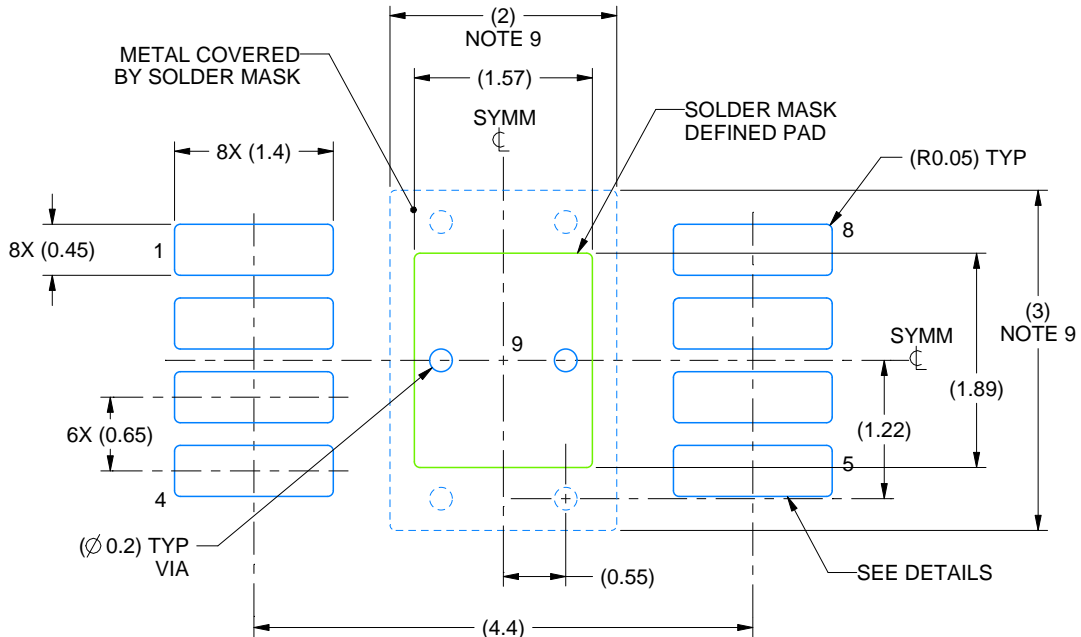

LAND PATTERN EXAMPLE
EXPOSED METAL SHOWN
SCALE: 15X



SOLDER MASK DETAILS

4225481/A 11/2019

NOTES: (continued)

6. Publication IPC-7351 may have alternate designs.
7. Solder mask tolerances between and around signal pads can vary based on board fabrication site.
8. Vias are optional depending on application, refer to device data sheet. If any vias are implemented, refer to their locations shown on this view. It is recommended that vias under paste be filled, plugged or tented.
9. Size of metal pad may vary due to creepage requirement.

EXAMPLE STENCIL DESIGN

DGN0008D

PowerPAD™ VSSOP - 1.1 mm max height

SMALL OUTLINE PACKAGE

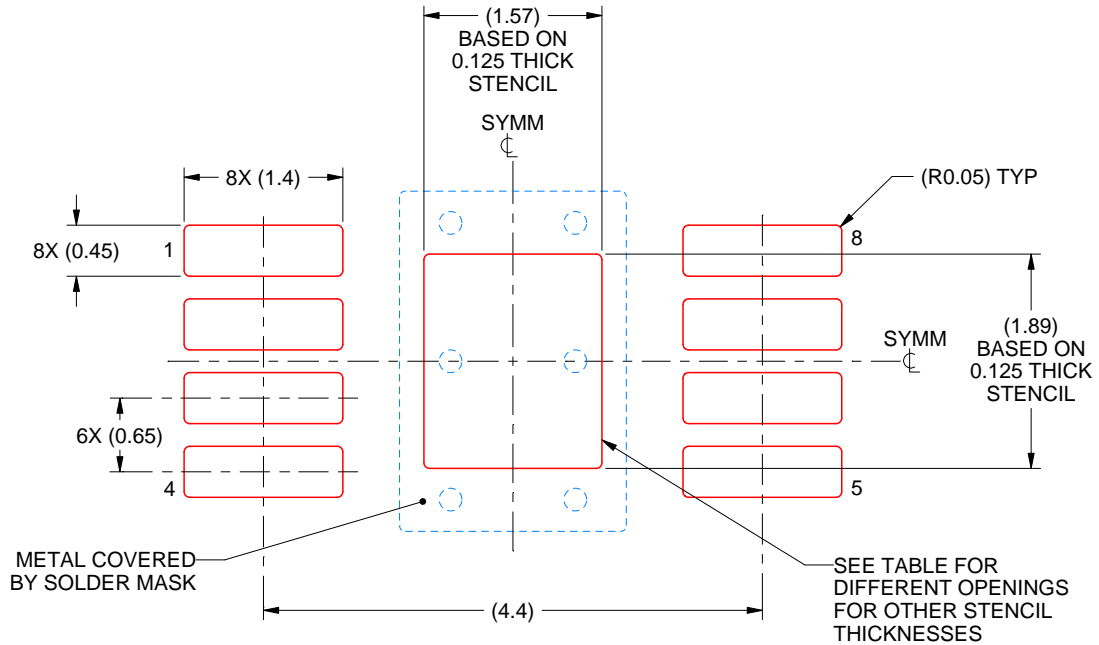

SOLDER PASTE EXAMPLE
EXPOSED PAD 9:
100% PRINTED SOLDER COVERAGE BY AREA
SCALE: 15X

STENCIL THICKNESS	SOLDER STENCIL OPENING
0.1	1.76 X 2.11
0.125	1.57 X 1.89 (SHOWN)
0.15	1.43 X 1.73
0.175	1.33 X 1.60

4225481/A 11/2019

NOTES: (continued)

10. Laser cutting apertures with trapezoidal walls and rounded corners may offer better paste release. IPC-7525 may have alternate design recommendations.
11. Board assembly site may have different recommendations for stencil design.



D0008A

PACKAGE OUTLINE

SOIC - 1.75 mm max height

SMALL OUTLINE INTEGRATED CIRCUIT



4214825/C 02/2019

NOTES:

- Linear dimensions are in inches [millimeters]. Dimensions in parenthesis are for reference only. Controlling dimensions are in inches. Dimensioning and tolerancing per ASME Y14.5M.
- This drawing is subject to change without notice.
- This dimension does not include mold flash, protrusions, or gate burrs. Mold flash, protrusions, or gate burrs shall not exceed .006 [0.15] per side.
- This dimension does not include interlead flash.
- Reference JEDEC registration MS-012, variation AA.

EXAMPLE BOARD LAYOUT

D0008A

SOIC - 1.75 mm max height

SMALL OUTLINE INTEGRATED CIRCUIT



LAND PATTERN EXAMPLE
EXPOSED METAL SHOWN
SCALE:8X



SOLDER MASK DETAILS

4214825/C 02/2019

NOTES: (continued)

6. Publication IPC-7351 may have alternate designs.

7. Solder mask tolerances between and around signal pads can vary based on board fabrication site.

EXAMPLE STENCIL DESIGN

D0008A

SOIC - 1.75 mm max height

SMALL OUTLINE INTEGRATED CIRCUIT



SOLDER PASTE EXAMPLE
BASED ON .005 INCH [0.125 MM] THICK STENCIL
SCALE:8X

4214825/C 02/2019

NOTES: (continued)

8. Laser cutting apertures with trapezoidal walls and rounded corners may offer better paste release. IPC-7525 may have alternate design recommendations.
9. Board assembly site may have different recommendations for stencil design.

IMPORTANT NOTICE AND DISCLAIMER

TI PROVIDES TECHNICAL AND RELIABILITY DATA (INCLUDING DATA SHEETS), DESIGN RESOURCES (INCLUDING REFERENCE DESIGNS), APPLICATION OR OTHER DESIGN ADVICE, WEB TOOLS, SAFETY INFORMATION, AND OTHER RESOURCES "AS IS" AND WITH ALL FAULTS, AND DISCLAIMS ALL WARRANTIES, EXPRESS AND IMPLIED, INCLUDING WITHOUT LIMITATION ANY IMPLIED WARRANTIES OF MERCHANTABILITY, FITNESS FOR A PARTICULAR PURPOSE OR NON-INFRINGEMENT OF THIRD PARTY INTELLECTUAL PROPERTY RIGHTS.

These resources are intended for skilled developers designing with TI products. You are solely responsible for (1) selecting the appropriate TI products for your application, (2) designing, validating and testing your application, and (3) ensuring your application meets applicable standards, and any other safety, security, regulatory or other requirements.

These resources are subject to change without notice. TI grants you permission to use these resources only for development of an application that uses the TI products described in the resource. Other reproduction and display of these resources is prohibited. No license is granted to any other TI intellectual property right or to any third party intellectual property right. TI disclaims responsibility for, and you will fully indemnify TI and its representatives against, any claims, damages, costs, losses, and liabilities arising out of your use of these resources.

TI's products are provided subject to [TI's Terms of Sale](#) or other applicable terms available either on [ti.com](https://www.ti.com) or provided in conjunction with such TI products. TI's provision of these resources does not expand or otherwise alter TI's applicable warranties or warranty disclaimers for TI products.

TI objects to and rejects any additional or different terms you may have proposed.

Mailing Address: Texas Instruments, Post Office Box 655303, Dallas, Texas 75265
Copyright © 2023, Texas Instruments Incorporated