

Fast Switching Emitter Controlled Diode Feature

- 1200 V Emitter Controlled technology
- Fast recovery
- Soft switching
- Low reverse recovery charge
- Low forward voltage
- Easy paralleling
- Qualified according to JEDEC⁰⁾ for target applications

Product Summary

V_{RRM}	1200	V
I_F	18	A
V_F	1.65	V
T_{jmax}	150	°C

PG-TO263-3-2

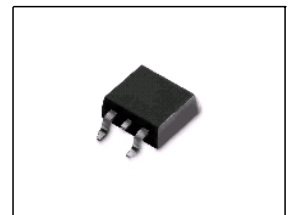

Type	Package	Ordering Code	Marking	Pin 1	PIN 2	PIN 3
IDB18E120	PG-TO263-3-2	-	D18E120	NC	C	A

Maximum Ratings, at $T_j = 25\text{ °C}$, unless otherwise specified

Parameter	Symbol	Value	Unit
Repetitive peak reverse voltage	V_{RRM}	1200	V
Continuous forward current	I_F	18	A
$T_C=25\text{ °C}$		31	
$T_C=90\text{ °C}$		19.8	
Surge non repetitive forward current	I_{FSM}	78	
$T_C=25\text{ °C}$, $t_p=10\text{ ms}$, sine halfwave			
Maximum repetitive forward current	I_{FRM}	47	
$T_C=25\text{ °C}$, t_p limited by T_{jmax} , $D=0.5$			
Power dissipation	P_{tot}	113	W
$T_C=25\text{ °C}$		113	
$T_C=90\text{ °C}$		54	
Operating and storage temperature	T_j, T_{stg}	-55...+150	°C
Soldering temperature reflow soldering, MSL1	T_S	260	°C

Thermal Characteristics

Parameter	Symbol	Values			Unit
		min.	typ.	max.	
Characteristics					
Thermal resistance, junction - case	R_{thJC}	-	-	1.1	K/W
Thermal resistance, junction - ambient, leaded	R_{thJA}	-	-	62	
SMD version, device on PCB: @ min. footprint @ 6 cm ² cooling area ¹⁾	R_{thJA}	-	-	62	
		-	35	-	

Electrical Characteristics, at $T_j = 25\text{ °C}$, unless otherwise specified

Parameter	Symbol	Values			Unit
		min.	typ.	max.	
Static Characteristics					
Reverse leakage current $V_R=1200V, T_j=25\text{ °C}$ $V_R=1200V, T_j=150\text{ °C}$	I_R	-	-	100 1400	μA
Forward voltage drop $I_F=18A, T_j=25\text{ °C}$ $I_F=18A, T_j=150\text{ °C}$	V_F	-	1.65 1.7	2.15 -	V

⁰J-STD20 and JESD22

¹Device on 40mm*40mm*1.5mm epoxy PCB FR4 with 6cm² (one layer, 70 μm thick) copper area for drain connection. PCB is vertical without blown air.

Electrical Characteristics, at $T_j = 25\text{ °C}$, unless otherwise specified

Parameter	Symbol	Values			Unit
		min.	typ.	max.	
Dynamic Characteristics					
Reverse recovery time $V_R=800\text{V}$, $I_F=18\text{A}$, $di_F/dt=800\text{A}/\mu\text{s}$, $T_j=25\text{°C}$ $V_R=800\text{V}$, $I_F=18\text{A}$, $di_F/dt=800\text{A}/\mu\text{s}$, $T_j=125\text{°C}$ $V_R=800\text{V}$, $I_F=18\text{A}$, $di_F/dt=800\text{A}/\mu\text{s}$, $T_j=150\text{°C}$	t_{rr}	-	195 280 300	-	ns
Peak reverse current $V_R=800\text{V}$, $I_F = 18\text{ A}$, $di_F/dt=800\text{A}/\mu\text{s}$, $T_j=25\text{°C}$ $V_R=800\text{V}$, $I_F = 18\text{A}$, $di_F/dt=800\text{A}/\mu\text{s}$, $T_j=125\text{°C}$ $V_R=800\text{V}$, $I_F = 18\text{A}$, $di_F/dt=800\text{A}/\mu\text{s}$, $T_j=150\text{°C}$	I_{rrm}	-	20.2 24.4 25.3	-	A
Reverse recovery charge $V_R=800\text{V}$, $I_F=18\text{A}$, $di_F/dt=800\text{A}/\mu\text{s}$, $T_j=25\text{°C}$ $V_R=800\text{V}$, $I_F = 18\text{A}$, $di_F/dt=800\text{A}/\mu\text{s}$, $T_j=125\text{°C}$ $V_R=800\text{V}$, $I_F = 18\text{A}$, $di_F/dt=800\text{A}/\mu\text{s}$, $T_j=150\text{°C}$	Q_{rr}	-	1880 3200 3540	-	nC
Reverse recovery softness factor $V_R=800\text{V}$, $I_F=18\text{A}$, $di_F/dt=800\text{A}/\mu\text{s}$, $T_j=25\text{°C}$ $V_R=800\text{V}$, $I_F=18\text{A}$, $di_F/dt=800\text{A}/\mu\text{s}$, $T_j=125\text{°C}$ $V_R=800\text{V}$, $I_F=18\text{A}$, $di_F/dt=800\text{A}/\mu\text{s}$, $T_j=150\text{°C}$	S	-	5.5 6.6 6.7	-	

1 Power dissipation

$P_{tot} = f(T_C)$

parameter: $T_j \leq 150^\circ\text{C}$

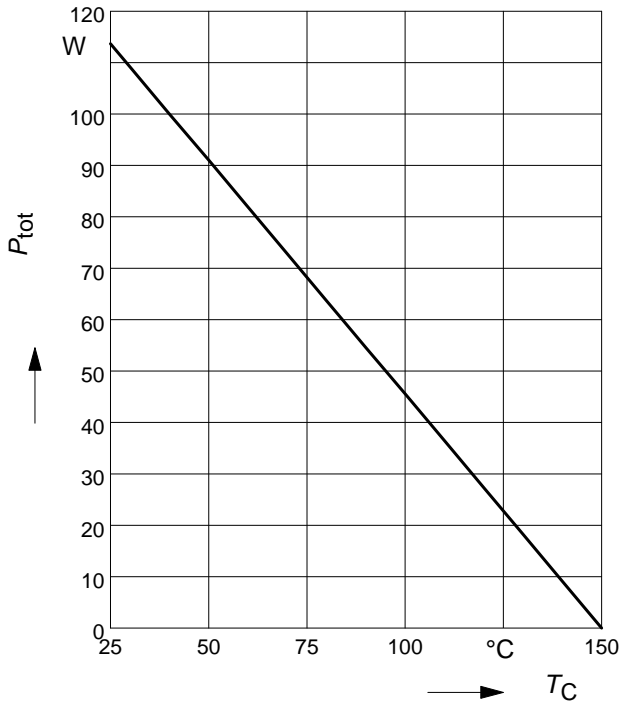

2 Diode forward current

$I_F = f(T_C)$

parameter: $T_j \leq 150^\circ\text{C}$

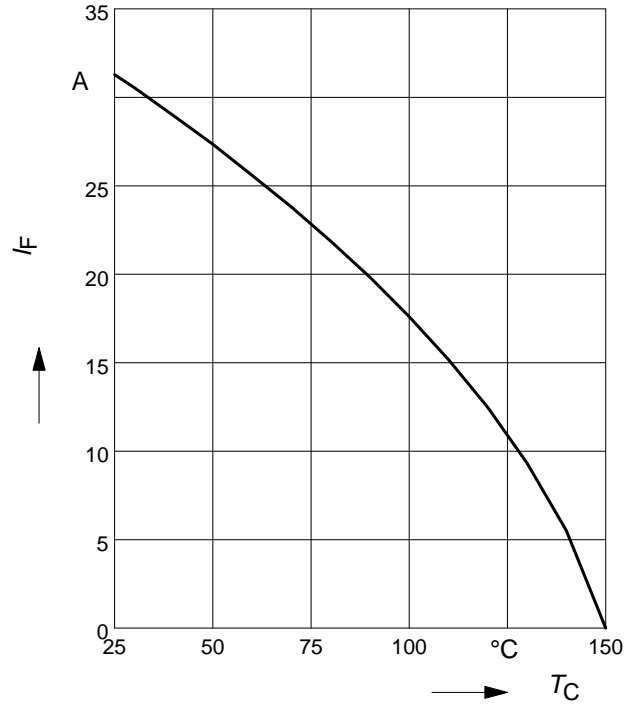

3 Typ. diode forward current

$I_F = f(V_F)$

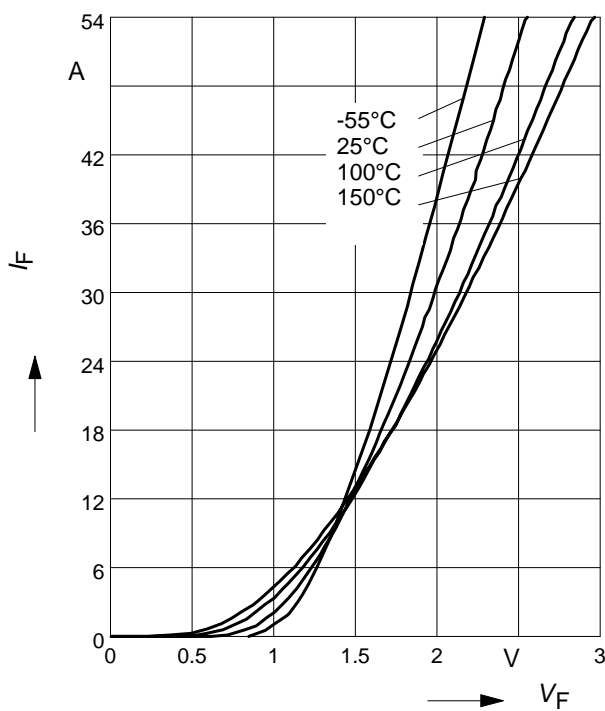

4 Typ. diode forward voltage

$V_F = f(T_j)$

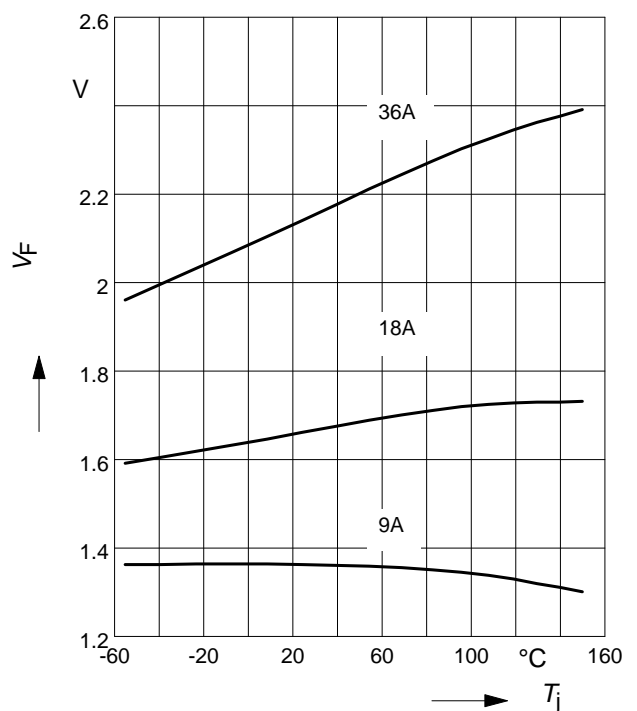

5 Typ. reverse recovery time

$$t_{rr} = f(dI_F/dt)$$

parameter: $V_R = 800V, T_j = 125^\circ C$

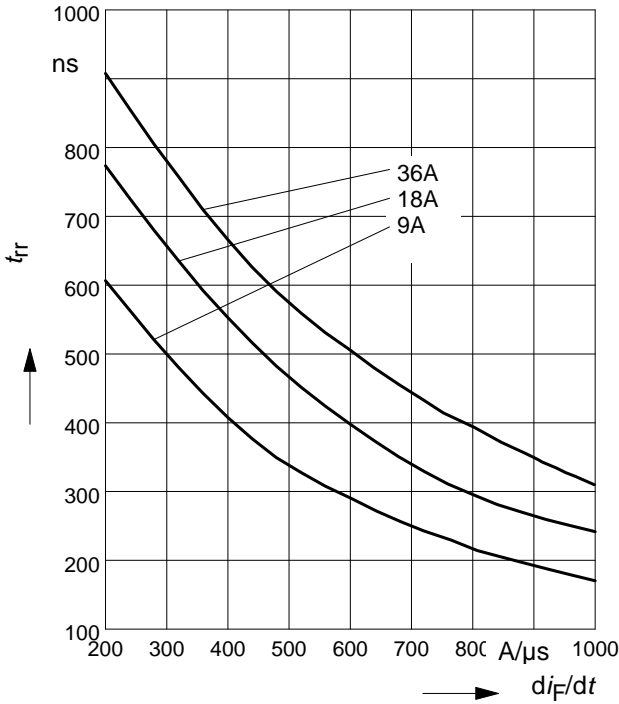

6 Typ. reverse recovery charge

$$Q_{rr} = f(dI_F/dt)$$

parameter: $V_R = 800V, T_j = 125^\circ C$

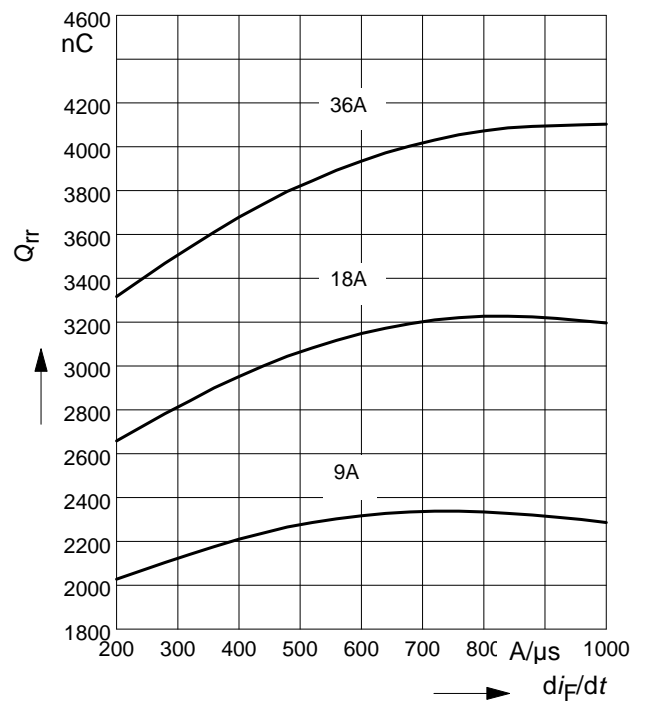

7 Typ. reverse recovery current

$$I_{rr} = f(dI_F/dt)$$

parameter: $V_R = 800V, T_j = 125^\circ C$

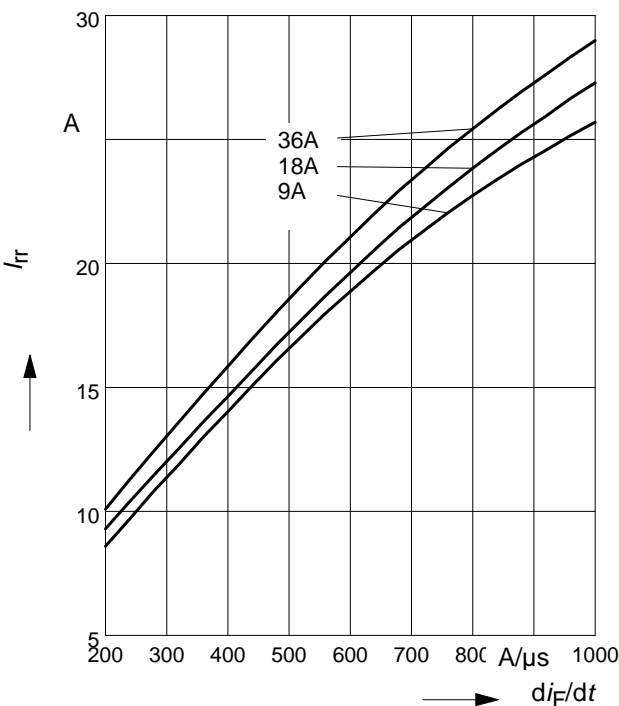

8 Typ. reverse recovery softness factor

$$S = f(dI_F/dt)$$

parameter: $V_R = 800V, T_j = 125^\circ C$

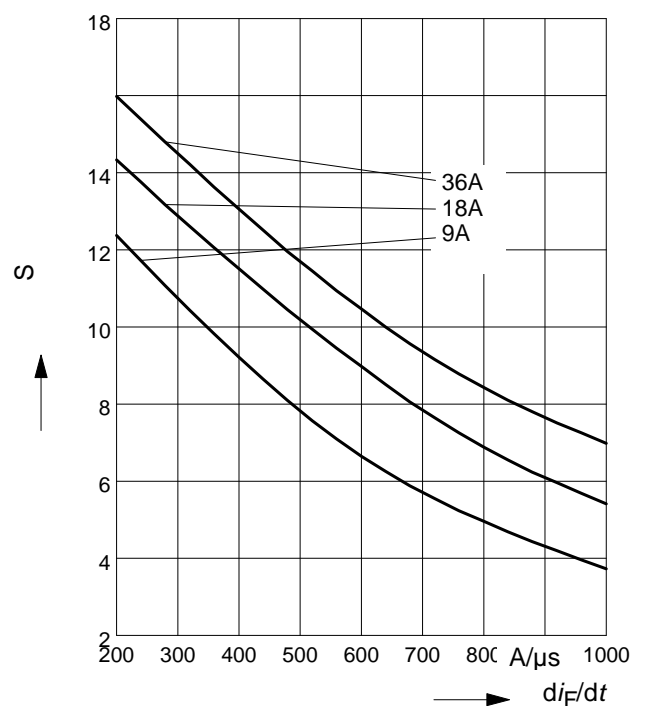

9 Max. transient thermal impedance

$$Z_{thJC} = f(t_p)$$

parameter : $D = t_p/T$

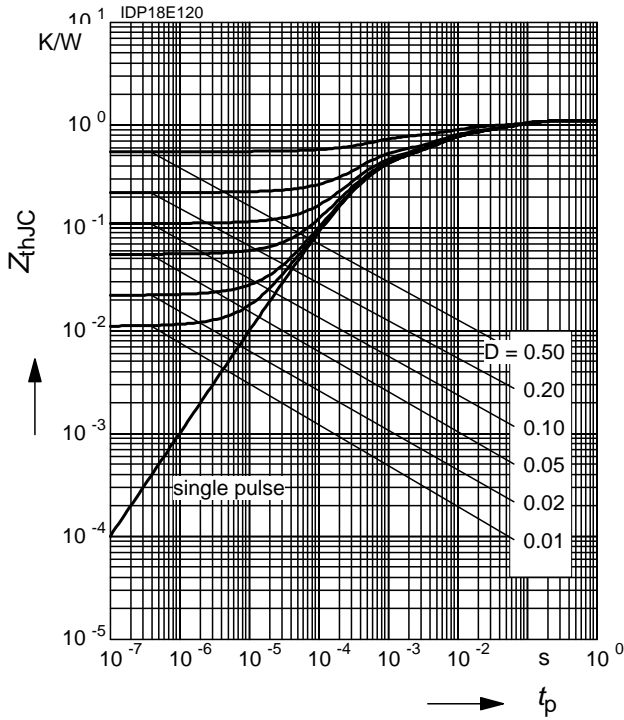

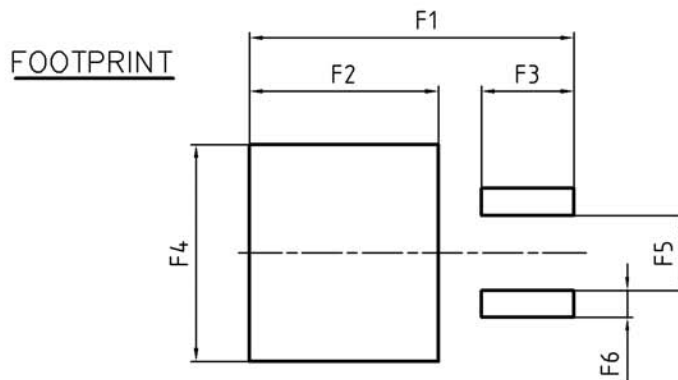
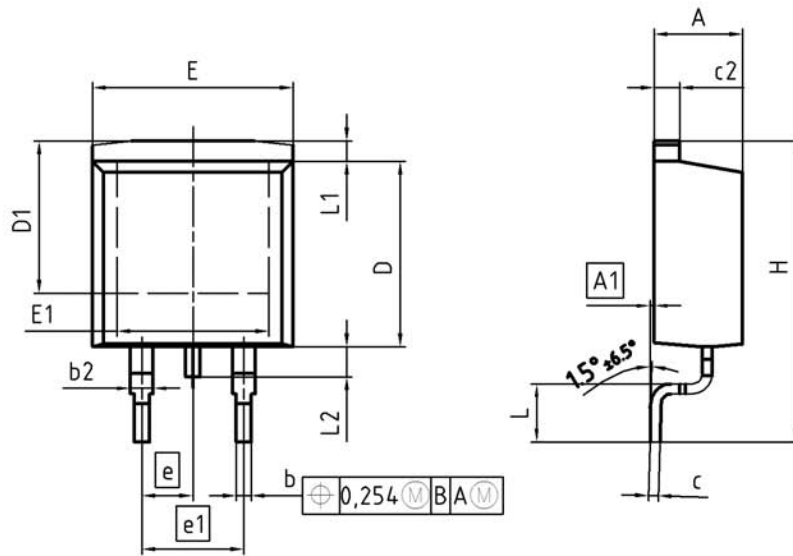

DIM	MILLIMETERS		INCHES	
	MIN	MAX	MIN	MAX
A	4.30	4.57	0.169	0.180
A1	0.00	0.25	0.000	0.010
b	0.65	0.85	0.026	0.033
b2	0.95	1.15	0.037	0.045
c	0.33	0.65	0.013	0.026
c2	1.17	1.40	0.046	0.055
D	8.51	9.45	0.335	0.372
D1	7.10	7.90	0.280	0.311
E	9.80	10.31	0.386	0.406
E1	6.50	8.60	0.256	0.339
e	2.54		0.100	
e1	5.08		0.200	
N	2		2	
H	14.61	15.88	0.575	0.625
L	2.29	3.00	0.090	0.118
L1	0.70	1.60	0.028	0.063
L2	1.00	1.78	0.039	0.070
F1	16.05	16.25	0.632	0.640
F2	9.30	9.50	0.366	0.374
F3	4.50	4.70	0.177	0.185
F4	10.70	10.90	0.421	0.429
F5	3.65	3.85	0.144	0.152
F6	1.25	1.45	0.049	0.057

DOCUMENT NO.
Z8B00003324

SCALE

EUROPEAN PROJECTION

ISSUE DATE
30-08-2007

REVISION
01

Published by
Infineon Technologies AG
81726 Munich, Germany
© 2013 Infineon Technologies AG
All Rights Reserved.

Legal Disclaimer

The information given in this document shall in no event be regarded as a guarantee of conditions or characteristics. With respect to any examples or hints given herein, any typical values stated herein and/or any information regarding the application of the device, Infineon Technologies hereby disclaims any and all warranties and liabilities of any kind, including without limitation, warranties of non-infringement of intellectual property rights of any third party.

Information

For further information on technology, delivery terms and conditions and prices, please contact the nearest Infineon Technologies Office (www.infineon.com).

Warnings

Due to technical requirements, components may contain dangerous substances. For information on the types in question, please contact the nearest Infineon Technologies Office.

The Infineon Technologies component described in this Data Sheet may be used in life-support devices or systems and/or automotive, aviation and aerospace applications or systems only with the express written approval of Infineon Technologies, if a failure of such components can reasonably be expected to cause the failure of that life-support, automotive, aviation and aerospace device or system or to affect the safety or effectiveness of that device or system. Life support devices or systems are intended to be implanted in the human body or to support and/or maintain and sustain and/or protect human life. If they fail, it is reasonable to assume that the health of the user or other persons may be endangered.