



Brand of NTN corporation

## Technical data

# 2206

Double-row self-aligning ball bearings



Self-aligning ball bearing, pressed steel cage, open

### VISUAL (S)

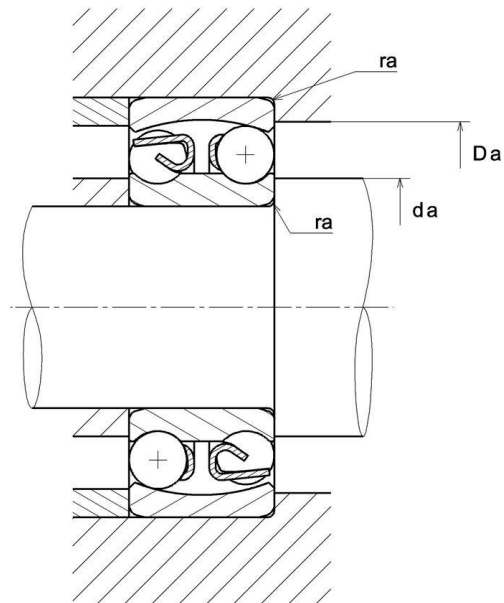
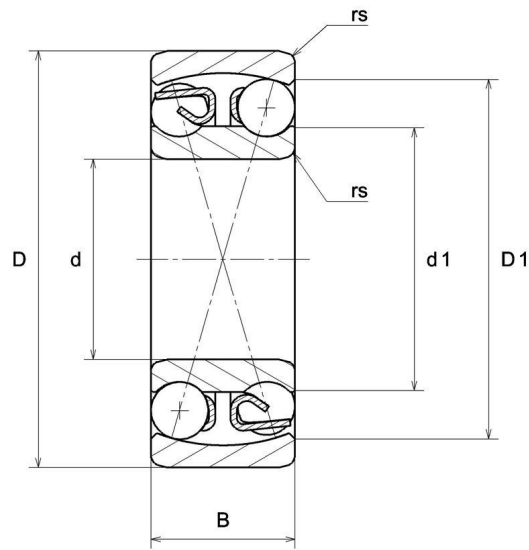

**NTN Europe**

1 rue des Usines · BP 2017 · 74010 Annecy Cedex · France · Tel. +33 (0)4 50 65 30 00  
S.A. au capital de 322 639 919 € · RCS ANNECY B 325 821 072 · Id. Fiscale : FR 48 325 821 072  
SIRET 325 821 072 00015 · Code APE 2815 Z · Code NACE 28.15

## PRODUCT DEFINITION

<b>Brand</b>	SNR
<b>d - Internal diameter</b>	30 mm
<b>D - External diameter</b>	62 mm
<b>B - Bearing/Inner ring width</b>	20 mm
<b>d1 - External diameter inner ring</b>	40,2 mm
<b>D1 - Inner diameter outer ring</b>	51,1 mm
<b>rs - Min fillet radius</b>	1 mm
<b>Radial clearance class</b>	CN
<b>Precision class</b>	P0
<b>Mass</b>	0,264 kg

## PRODUCT PERFORMANCE

<b>C - Dynamic load</b>	15000000 mN
<b>C0 - Static load</b>	4550000 mN
<b>Cu - Fatigue limit load</b>	210000 mN
<b>e - Coefficient</b>	0.4
<b>Y0 - Static axial load coefficient</b>	1.67
<b>Y1 - Lower axial load coefficient</b>	1.59
<b>Y2 - Upper axial load coefficient</b>	2.47
<b>Nref - Reference thermal speed</b>	66000 °/s
<b>Nlim - Mechanical Limit Speed</b>	84000 °/s
<b>Tmin - Min operating temperature</b>	233,15 °K
<b>Tmax - Max operating temperature</b>	393,15 °K



## BEARING FREQUENCIES

<b>BPFO - Characteristic outer ring frequency (60 rpm)</b>	5.816 Hz
<b>BPFI - Characteristic inner ring frequency (60 rpm)</b>	8.184 Hz
<b>FTF - Characteristic cage frequency (60 rpm)</b>	0.415 Hz
<b>BSF - Characteristic rolling element frequency (60 rpm)</b>	5.553 Hz

## ABUTMENT

<b>da min - Min shoulder diameter IR</b>	35 mm
<b>Da max - Max shoulder diameter OR</b>	57 mm
<b>ra max - Max shaft &amp; housing fillet radius</b>	1 mm

