

SPCM-AQRH

Single Photon Counting Module



Excelitas Technologies' newly improved SPCM-AQRH Single Photon Counting Module detects single photons over the wavelength range of 400nm to 1060nm with performance parameters superior to other solid state or vacuum-tube based photon counters.

The SPCM-AQRH uses a unique silicon avalanche photodiode (SLiK) with a circular active area, achieving peak photon detection efficiency of approximately 70% at 650nm over a 180 μ m diameter with unmatched uniformity over the full active area. A TTL level pulse is generated for each photon detected and the signal is available at the BNC connector at the rear of the module. The signal should be terminated into 50 Ω .

The photodiode is both thermoelectrically cooled and temperature controlled, ensuring stabilized performance despite ambient temperature changes. Operating temperature range has been increased and the module (case temperature) will function between 5 $^{\circ}$ C and 70 $^{\circ}$ C.

Recent electronic circuit improvements have reduced the minimum dead time to less than 25ns, thereby increasing linearity and improving the dynamic range of the module. Timing resolution of the module was also improved significantly. The SPCM-AQRH has internal protection circuitry that protects the avalanche photodiode and the module electronics from damage due to accidental overload from exposure to ambient lighting.

Excelitas' series of photon counting modules are designed and built to be fully compliant with the European Union's RoHS Directive 2011/65/EU.

Key Features

- Peak PDE: > 70% @ 700nm
- 180 μ m active area
- > 35 Mcps dynamic range
- Gated output
- Single +5 V supply
- RoHS-compliant
- Low after pulse probability
- High uniformity over large active area
- Unmatched linearity

Applications

- LIDAR
- Quantum Cryptography
- Photon correlation spectroscopy
- Astronomical observation
- Optical range finding
- Adaptive optics
- Ultra-sensitive fluorescence
- Particle sizing

SPCM-AQRH Series
Single Photon Counting Module

Table 1. Specifications of SPCM-AQRH-WX, @ 22 °C, all models, unless otherwise indicated

Parameter	Min	Typ	Max	Unit
Supply voltage ⁽¹⁾	4.75	5.0	5.25	V
Supply current		0.4	1.2	A
Power cable total resistance		0.1	0.2	Ω
Case operating temperature ^(1, 3)	5		70	°C
Active area (diameter) at minimum PDE	170	180		μm
Photon detection efficiency (PDE) (without FC adaptor) ^(10, 11) at:				
400nm	2	5		%
650nm	50	65		%
830nm	35	45		%
1060nm	1	2		%
Refer to SPCM-NIR family for red – NIR optimized/selected modules, see Figure 4				
Dark Count ^(4, 5, 6)				
SPCM-AQRH-W0			1500	Counts / second
SPCM-AQRH-W1			1000	
SPCM-AQRH-W2			500	
SPCM-AQRH-W3			250	
SPCM-AQRH-W4			100	
SPCM-AQRH-W5			50	
SPCM-AQRH-W6			25	
See table 3.				
Output pulse width ⁽⁹⁾				
SPCM-AQRH-1X, SPCM-AQRH-4X		10		ns
SPCM-AQRH-2X, SPCM-AQRH-5X		18		ns
SPCM-AQRH-3X, SPCM-AQRH-6X		28		ns
See table 3.				
Dead time (count rate below 5M/c)				
SPCM-AQRH-1X, SPCM-AQRH-4X		22		ns
SPCM-AQRH-2X, SPCM-AQRH-5X		28		ns
SPCM-AQRH-3X, SPCM-AQRH-6X		35		ns
See table 3.				
Output pulse amplitude:				
SPCM-AQRH-1X, SPCM-AQRH-2X, SPCM-AQRH-3X				
TTL HIGH	1.5	2.2		V
TTL LOW	-0.1		0.8	V
See table 3.				
SPCM-AQRH-1X, SPCM-AQRH-2X, SPCM-AQRH-3X				
TTL HIGH	3.0	4.4		V
TTL LOW	-0.1		0.8	V
See table 3.				
Average dark count variation at constant case temperature (6 hrs. at 25 °C) ^(4, 5, 6)				
SPCM-AQRH-W0, W1, W2, W3			± 10	%
SPCM-AQRH-W4, W5, W6			± 1	σ

SPCM-AQRH Series

Single Photon Counting Module

Parameter	Min	Typ	Max	Unit
Variation of average dark count rate at 5°C to 70°C case temperature for ^(4, 5, 6) SPCM-AQRH-W0, W1, W2, W3 SPCM-AQRH-W4, W5, W6			± 20 ± 2	% σ
Single photon timing resolution (at 825nm) ⁽¹²⁾ Please refer to SPCM-AQRH-TR family for optimized timing modules		350		ps
Output count rate before saturation ⁽⁸⁾	12	37		Mc/s
Afterpulsing probability ⁽¹³⁾		0.5	1	%
Setting time following power up (1% stability) at 1 Mc/s and 25°C		15	20	s
Linearity correction factor ⁽⁷⁾ at 200 Kc/s 1 Mc/s 5 Mc/s 10 Mc/s 20 Mc/s 25 Mc/s		1 1.02 1.16 1.40 2.35 3.32		
Threshold setting required on counter for digital output pulse (terminate in 50Ω)		1.0		V
Gating turn on/off (50Ω output) Disable = TTL low (<0.8V) Enable = TTL high (>2.0V)		40 60	45 65	ns
Gating threshold voltage (at V supply = 5V) Low level (sink current >90mA) High level (sink current >30mA)	0 2.0		0.4 5.25	V

Refer to Operating Instructions below for noted items

Operating Instructions

1. Connection to incorrect voltage or reverse voltage may damage or destroy the module. The warranty is invalid should such damage occur. The center contact of the barrel type power connector (corresponding to the white stripe on the wire) is +5V.
2. These modules are not qualified for shock or vibration other than normal instrumentation environments.
3. The module dissipates a mean power of 2.0W and a maximum power of 6W at high count rate and 70°C. Adequate heat sinking must be provided by clamping the module to a suitable heat sink via the holes in the module base. To meet specified performance, the module case temperature must not exceed 70°C. See Figure 6 for stability of probability of detection vs. temperature.
4. On a small percentage of delivered modules, bi-stability of the dark count has been observed. Research indicates this bi-stability is probably due to transitions at a single impurity site between a low energy and a high energy state.

The phenomenon is seen as an abrupt change in the dark count rate, e.g., 350 to 390 c/s., and the dark count switches between the two states at a rate dependent upon the detector temperature. Multilevel switching has also been observed, where more than one impurity site is switching.

SPCM-AQRH Series

Single Photon Counting Module

5. Long-term bi-stability is related to fundamental semiconductor physics and is beyond Excelitas' control. Warranty claims will not be considered against bi-stability alone.

Warranty claims will only be considered if the high level of the dark count exceeds the maximum level in the specification.

6. In the dark, the module generates random counts that follow a Poisson distribution. In a Poissonian process, the standard deviation is equal to the square root of the average count. In this specification the "dark count variation" refers to the stability of the average count of the module.

7. The actual photon rate could be calculated using the following equation, as indicated in Note #7 in the box below:

Note # 7: Actual photon rate calculation

$$\text{ACTUAL COUNTRATE Photons} = \frac{(\text{OUTPUT ModuleCountRate} \times \text{CORRECTIONFACTOR @ the Module CountRate}) - \text{DARK COUNT Module}}{\text{PHOTON DETECTION EFFICIENCY Module}}$$

The theoretical value, at low count rate, of the Correction Factor follows this equation:

$$\text{Correction Factor} = \frac{1}{1 - (t_d \times C_R)} \quad \text{Where: } t_d = \text{Module Dead Time}$$

$$C_R = \text{Output Count Rate}$$

The deviation from an ideal linear system is another way of looking at the saturation effect. The following equations show how to calculate this departure from the linearity:

$$\text{LINEARITY} = \left[\frac{\text{OUTPUT ModuleCountRate}}{(\text{PHOTONS Actual Count Rate} \times \text{PHOTON DETECTION EFFICIENCY Module}) + \text{DARK COUNT Module}} \right]^{-1}$$

$$= \left[\frac{1}{\text{Correction Factor}} \right]^{-1}$$

8. For the typical dead time setting of 22ns, typical maximum count rate is 37Mc/s before saturation. If the longest output pulse width option is set (28ns), the typical maximum count rate is 30Mc/s before saturation. If the maximum dead time setting is used, about 62ns, typical maximum count rate would be about 12Mc/s. Note that using a longer dead time will degrade linearity.

9. Output pulse width is set at the standard of 10ns ± 2ns at 2.2V. Other output pulse widths can be set. Please refer to Table 3, Ordering Guide, for which model number to order.

10. Output pulse height standard is set to 2.2V ± 0.4V. Optional output pulse height is 4.4V. Please refer to Table 3, Ordering Guide, for which model number to order.

11. If needed, an FC fibre adaptor can be factory installed on the SPCM-AQRH module allowing optical fibres to be used. The FC adaptor is optimized for use at 550 nm and with a 100µm core multimode fibre. If other wavelengths or fibre sizes are needed, please contact the factory for availability. The addition of an FC adaptor will cause a small drop in the effective PDE of the module. The amount of the loss will depend on the wavelength and the diameter of the fibre used to provide optical input to the module. Typically, one can expect around a 5% loss with a 100µm core fibre at 550nm.

12. Red-NIR wavelength photon detection efficiency can be optimized. PDE is enhanced over the 700-900nm wavelength range. Please refer to the Product Brief of the SPCM-NIR series. See Figure 4 for the typical photon efficiency of standard and enhanced PDE modules.

SPCM-AQRH Series

Single Photon Counting Module

13. Timing resolution is measured using a 10µm diameter light spot, at 825nm, and with case temperature at 22°C. For timing resolution requirements of larger spot size measurement, or at different wavelengths, please contact Excelitas. For timing resolution optimized modules, please refer to the Product Brief of the SPCM-AQRH-TR series

14. Afterpulse is measured for the first 500ns (excluding the first 75ns) on the time line of the afterpulse curve, at an average count rate of 100kc/s ± 20kc/s.

Table 2. Absolute Maximum Ratings

Supply voltage ⁽¹⁾	5.5 V
Maximum count rate	Maximum count rate can be sustained if case temperature is maintained within limit specified limits
Peak light intensity	maximum 10 ⁴ photons / pulse, pulse width < 1ns
Case temperature ⁽³⁾	-20°C/+85°C storage, +5°C /+70°C operating

Table 3. SPCM Ordering Guide

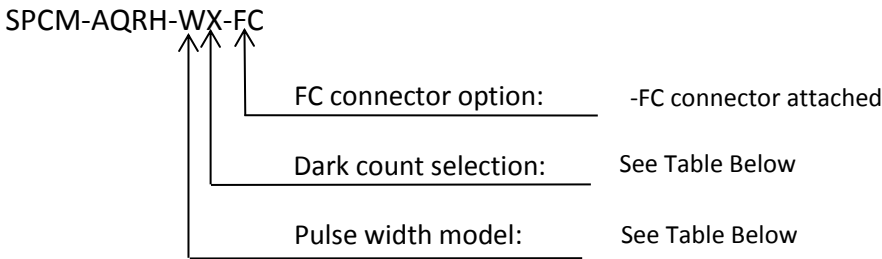

Order Part#	W - Output Pulse Options			X - Dark Count Rates						
	WX	Output Pulse Width (ns)	Dead Time (ns)	Output Pulse Height (V)	-W0	-W1	-W2	-W3	-W4	-W5
SPCM-AQRH-1X	10	22	2.2	≤1500 cps	≤1000cps	≤500pcs	≤250pcs	≤100cps	≤50cps	≤25cps
SPCM-AQRH-2X	18	28	2.2	≤1500 cps	≤1000cps	≤500pcs	≤250pcs	≤100cps	≤50cps	≤25cps
SPCM-AQRH-3X	28	35	2.2	≤1500 cps	≤1000cps	≤500pcs	≤250pcs	≤100cps	≤50cps	≤25cps
SPCM-AQRH-4X	10	22	4.4	≤1500 cps	≤1000cps	≤500pcs	≤250pcs	≤100cps	≤50cps	≤25cps
SPCM-AQRH-5X	18	28	4.4	≤1500 cps	≤1000cps	≤500pcs	≤250pcs	≤100cps	≤50cps	≤25cps
SPCM-AQRH-6X	28	35	4.4	≤1500 cps	≤1000cps	≤500pcs	≤250pcs	≤100cps	≤50cps	≤25cps

Table 4. Fibre Ordering Guide

Part Number	Fibre Type	Connector Type	Diameter			Numerical Aperture
			Core	Cladding	Outer	
SPCM-QC4	Multimode	FC/bare	62.5um	125um	2.5mm	0.27
SPCM-QC6	Multimode	FC/bare	100um	140um	2.5mm	0.29
SPCM-QC8	Multimode	as SPCM-QC6 but 905 SMA on free end				
SPCM-QC9	Multimode	as SPCM-QC6 but FC connector on free end				

Single Photon Counting Module

Figure 1. Module Block Diagram

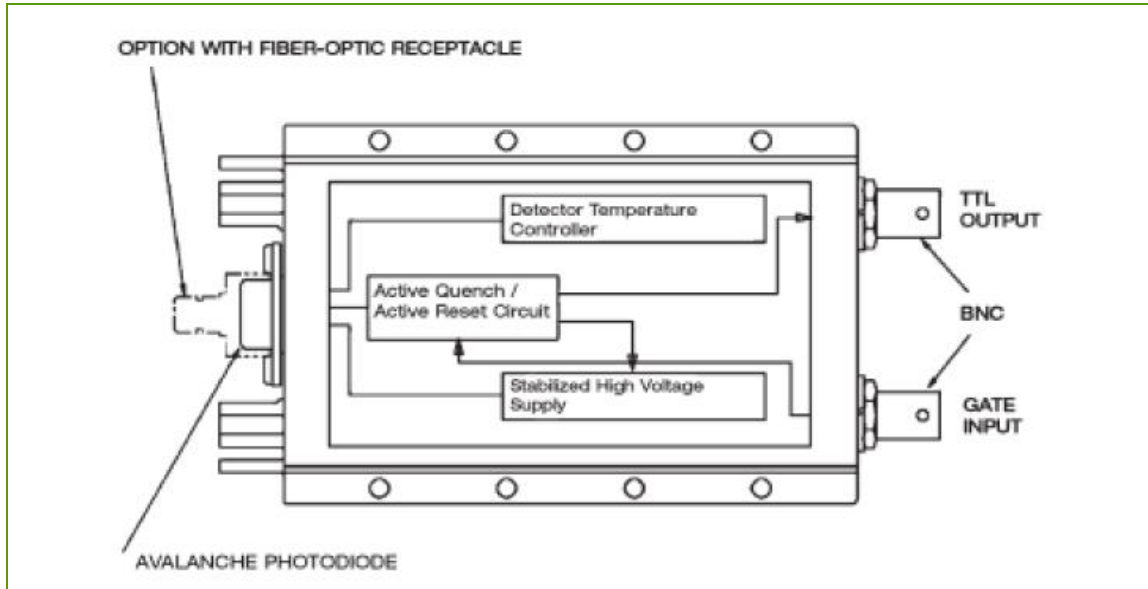

Figure 2. Electrical Connections

OUTPUT CONNECTOR

The digital OUTPUT pulse (BNC connector, TTL levels, >1.5V) should be terminated into a 50Ω load to avoid distortion and ringing. A 1.0V triggering level is recommended on counters and oscilloscopes to avoid triggering on noise. Note that TTL stands for Transistor-Transistor Logic.

GATE CONNECTOR

The GATE input (BNC connector) impedance is 50Ω and is internally connected to the +5 volt supply through a 50Ω pull-up resistor (standard module versions). It can be driven by standard TTL level signals. The gate drive must be capable of sinking 100 mA to gate the module “off” (5V/50Ω). Operation: TTL high – module counts, TTL low – counting disabled.

POWER CONNECTOR

The +5V power connector is a standard barrel connector (2.5mm I.D., 5.5mm O.D.) with an 18 AWG cable. The center stripe corresponds to the center of the barrel and connects to the positive terminal of the 5V supply. Reversal of the wires may damage the module.

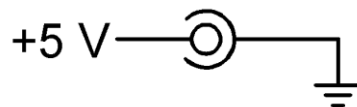

SPCM-AQRH Series

Single Photon Counting Module

Figure 3. Typical SPCM-AQRH PDE Scan at 650 nm

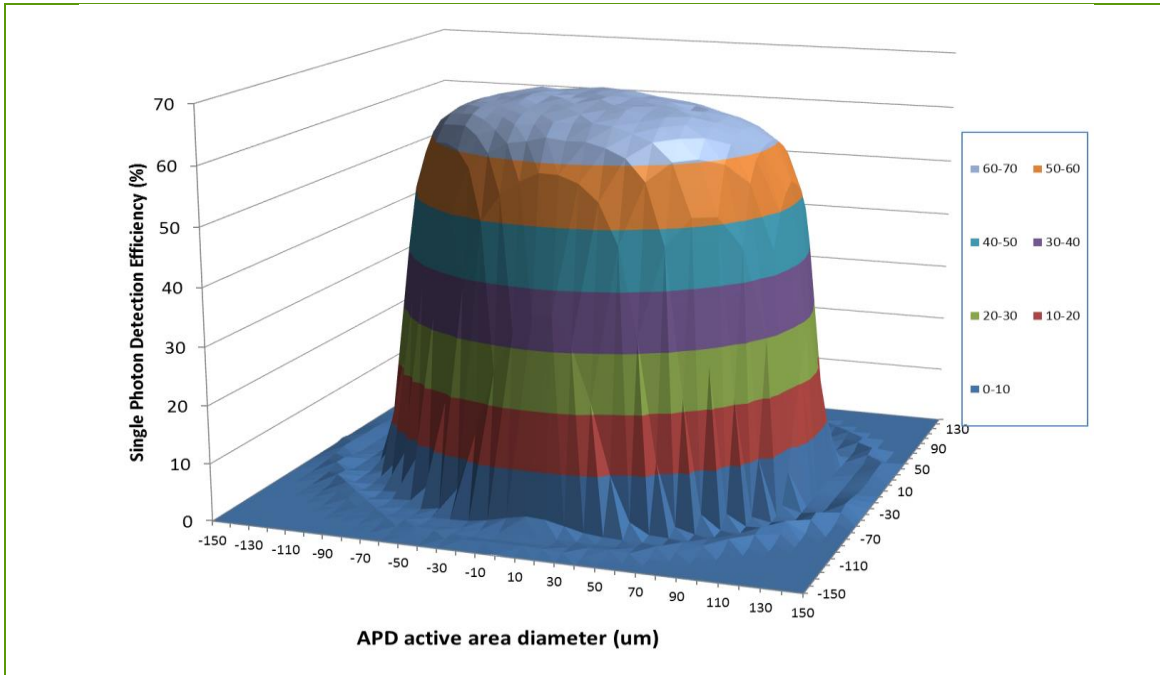
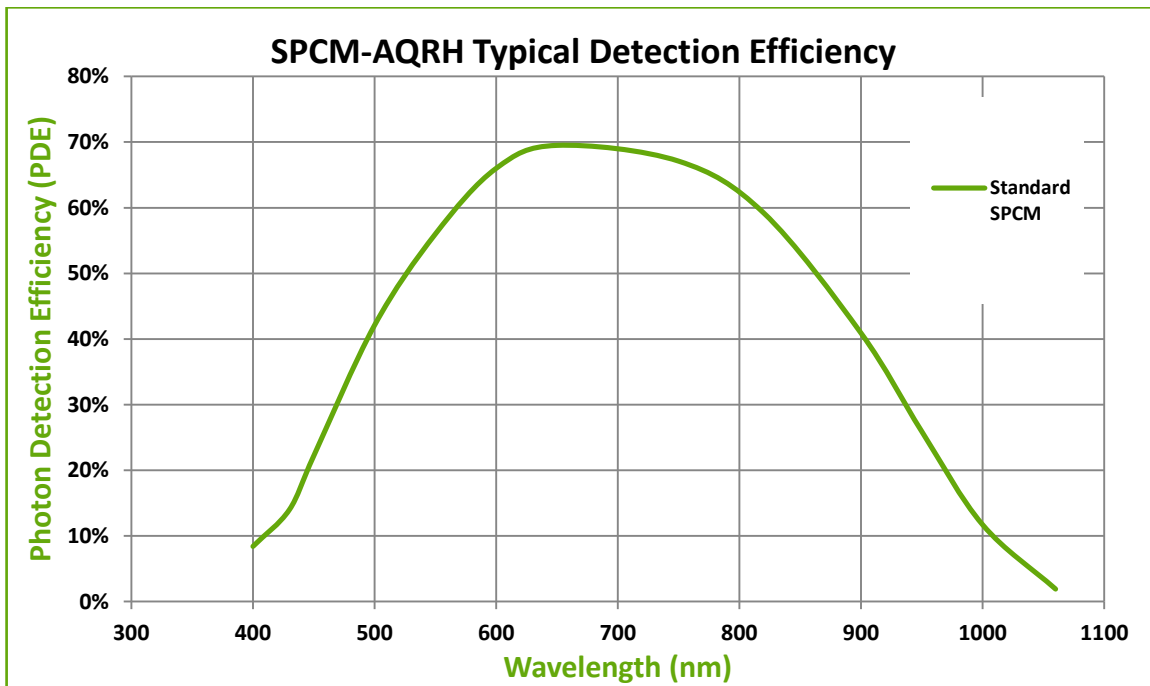

Figure 4. Typical Photon Detection Efficiency (PDE) vs. Wavelength



Single Photon Counting Module

Figure 5. Photon detection probability (PD) uniformity vs. Light spot size

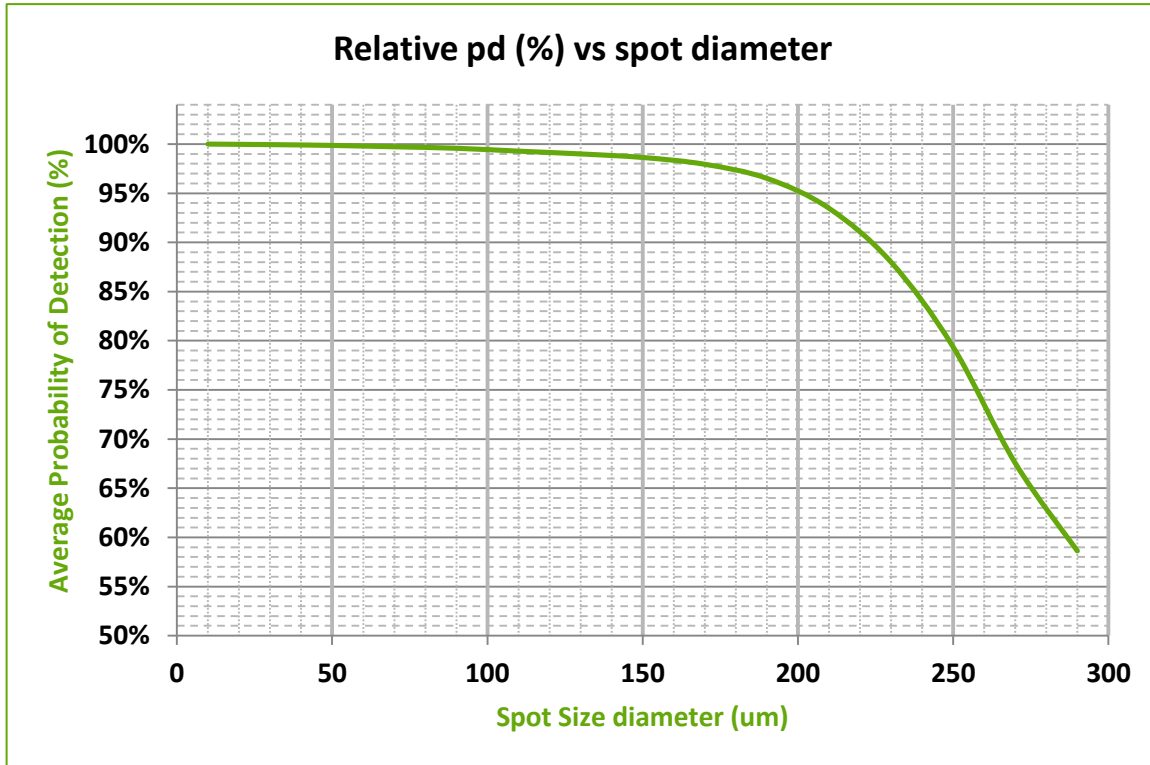
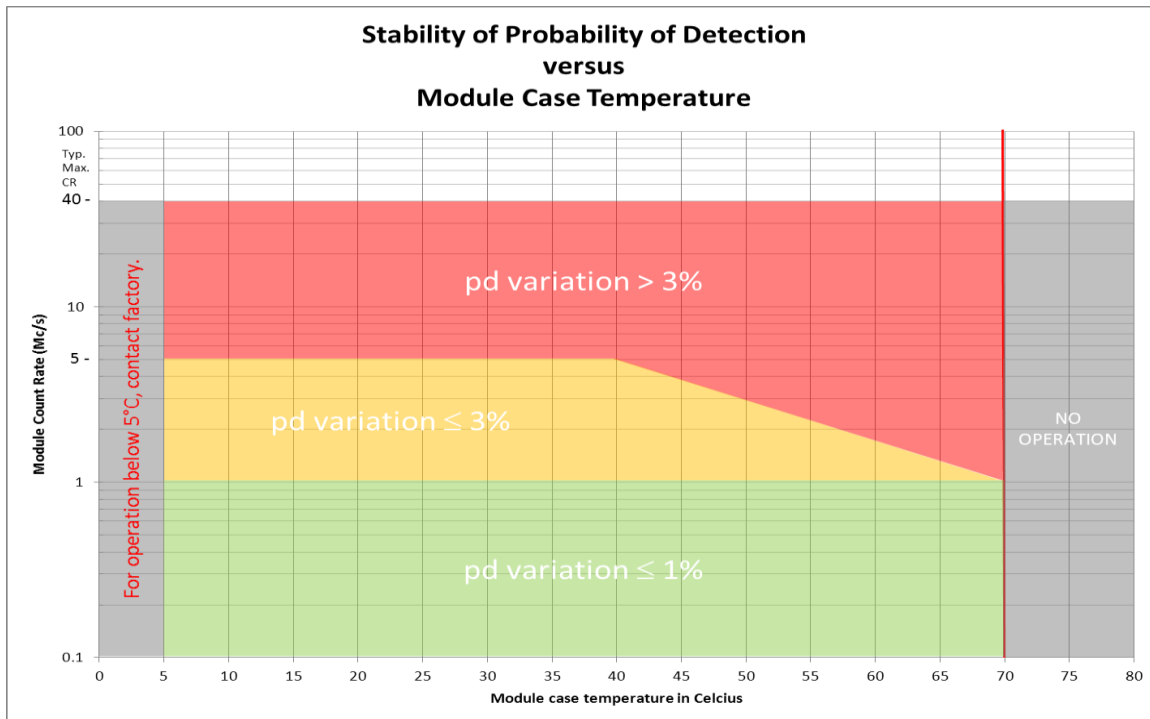

Figure 6. Probability of Detection Variation vs. Module case Temperature



SPCM-AQRH Series
Single Photon Counting Module

Figure 7. Typical Correction Factor

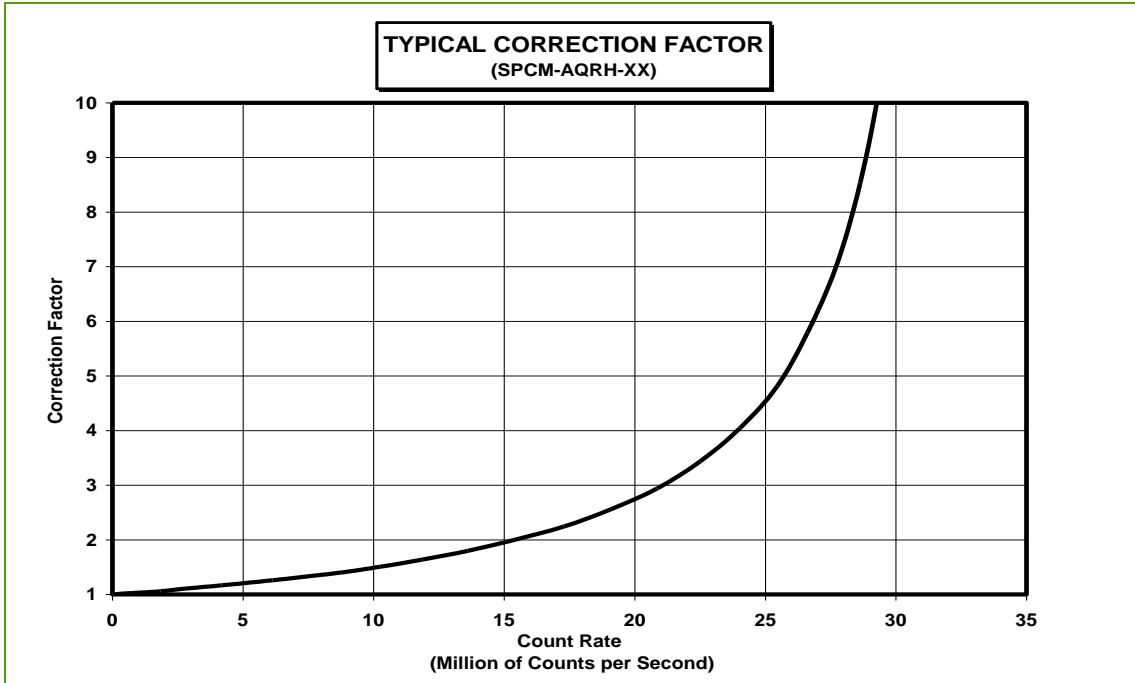
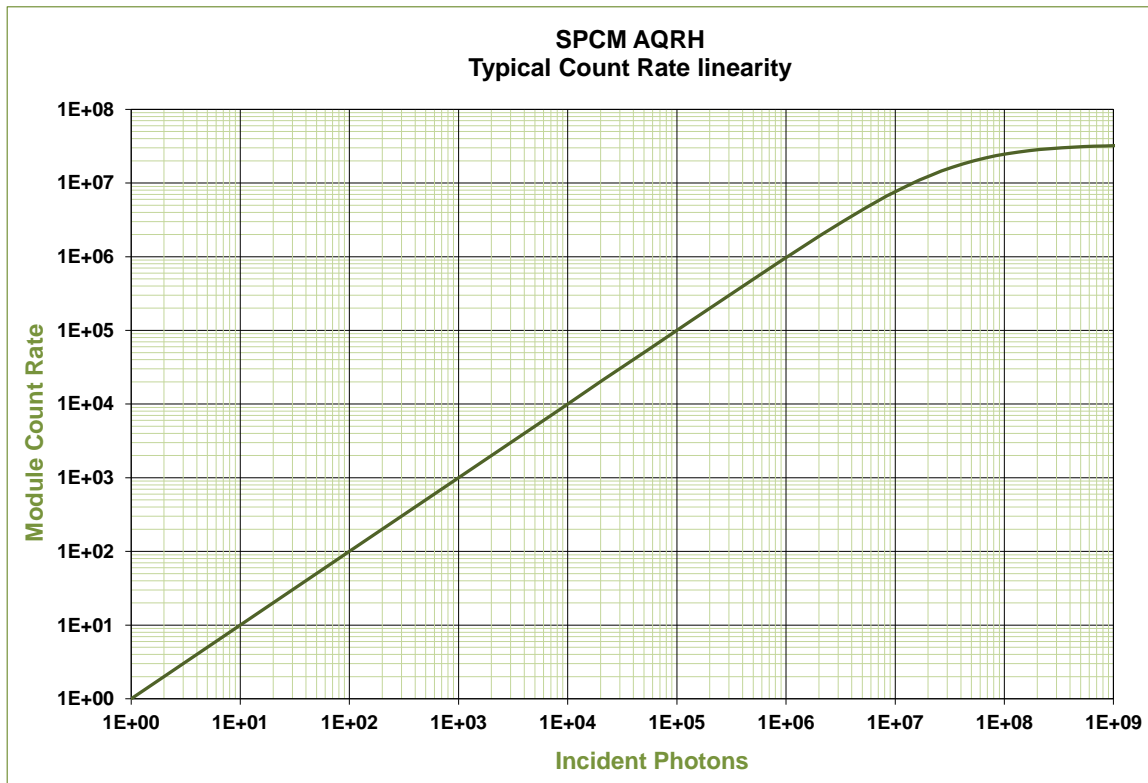

Figure 8. Count Rate Linearity



SPCM-AQRH Series

Single Photon Counting Module

Figure 9. Optical Power vs. Number of Photons

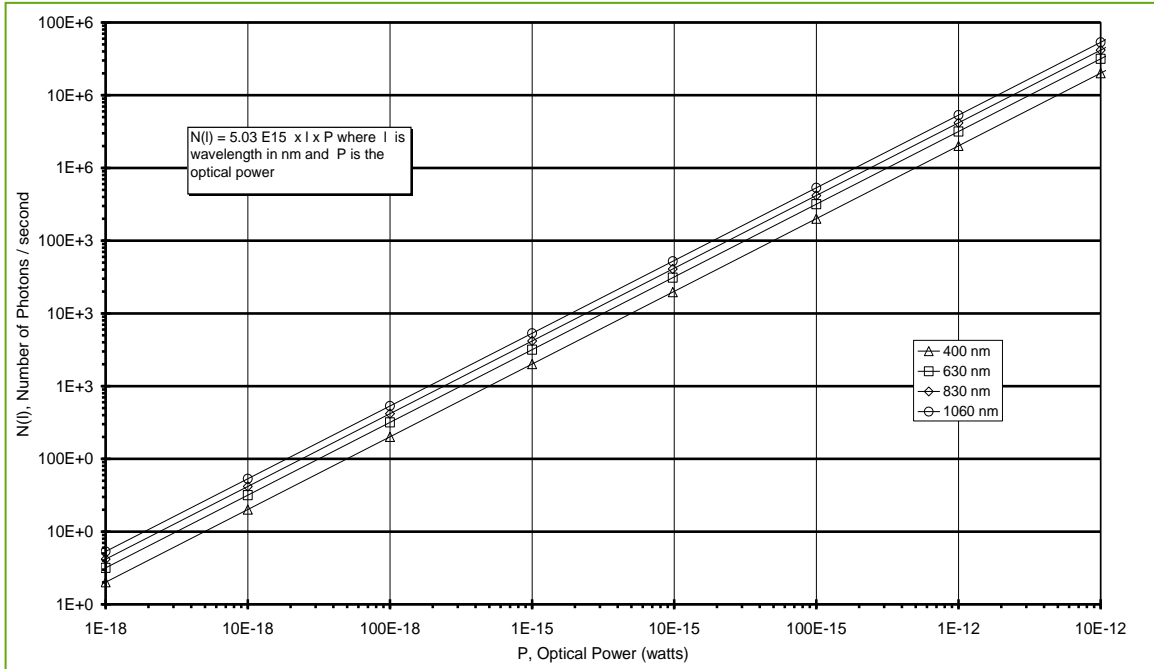
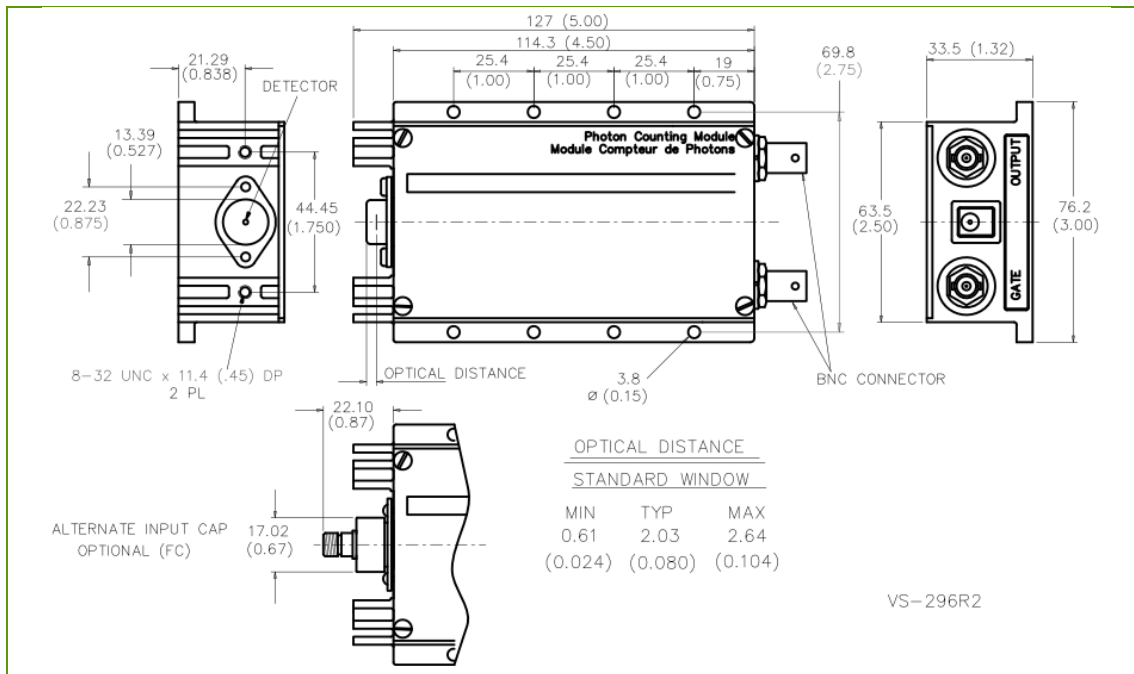

Figure 10. Dimensional Outline



Single Photon Counting Module

Saturation

The photon count decreases at higher incoming light levels. The count at which the output rate starts to decrease is called the saturation point. As an extreme example, if the module is exposed to intense light the count rate will fall to zero. While the module is protected against light overload, precautions should be taken to avoid any excessive light level that will damage the SPCM module. After an over exposure, the dark count of the module could increase temporarily for up to an hour. For faster recovery, it is recommended to power off the module and leave it in the dark for one to two minutes prior to restarting.

Fibre Connection Option

The SPCM-AQRH-WX-FC has an “FC” fibre-optic receptacle pre-aligned to the optical detector. Optical fibres with an FC connector on one end are available separately, (see Ordering Guide 2). The standard fibre lens is optimized for 550nm. Though the fibre / GRIN in the standard module will function through the complete range of 400nm to 1060nm, due to the wavelength-dependence of the graded index coupling lens, improvements to operating wavelengths other than 550 nm are special orders. The photon detection efficiency of connectorized modules is about 95% of that quoted for standard modules at 550nm.

Fibre Shielding

When used with optical fibres, both the fibre jacket and the connector shrouds must be completely opaque. Otherwise, stray light will increase the count rate. The SPCM-QCX pigtailed conform to this requirement (see Ordering Guide 2).

Gating Function

A gating function is provided with each module – useful for viewing a signal that occurs only in a small timeframe window. Also, in some applications the background light flux is higher than the signal. In this case, the gating option could be used to improve the S/N ratio by opening a window only when the light signal is present. The output of the module and the active quench function are disabled when a TTL low level is applied to the module gate input. When a TTL high level is applied to the module gate input, the output of the module and the active quench circuit are enabled again. Any photon detection that occurs less than 2 μ s before the module gate input changes can result in an output pulse. However, this output pulse has lost timing accuracy.

Light Emission during Photon Detection

One peculiarity of silicon avalanche photodiodes is that as an incoming photon is detected a small amount of light is emitted from the avalanche region. The emitted light has a broad spectral distribution. In most cases, this is not a problem. However, it can cause some confusion if another detector is monitoring light, or if the optical system is such that light emitted from the SPCM-AQRH is reflected back on itself. If these photons return more than 20 ns after the initial event, they will be detected.

Safety Warning



The SPCM-AQRH contains a **high voltage power supply**. Users may be injured if the case is opened. All internal settings are pre-set; there are no user adjustments.



Units that appear defective or have suffered mechanical damage should not be used because of possible electrical shorting of the high voltage power supply. Opening the case may damage sensitive components and expose the user to the risk of electrical shock. Please contact factory for repairs.

SPCM-AQRH Series

Single Photon Counting Module

RoHS Compliance

This series of avalanche photodiode modules are designed and built to be fully compliant with the European Union Directive 2011/65/EU – Restriction of the use of certain Hazardous Substances in Electrical and Electronic equipment.



Warranty

A standard 12-month warranty following shipment applies. Any warranty is null and void if the module case has been opened. Warranty is null and void if the module input exceeds 5.5 V or the polarity of the +5 V supply is reversed.

ESD Warning

Modules should only be handled at an ESD-safe work station.

Individual Module Test Data

Each module is supplied with test data indicating the module's actual dark count, dead time, pulse width, photon detection efficiency @ 630nm (550nm for fiber-coupled versions), correction factor and linearity.

Declaration of Conformity

This product is eligible to bear the ETL mark with adjacent indicator 'C' and 'US'. The Intertek control number is 4010815.



Products:

CLASS 8721 85 ELECTRICAL EQUIPMENT FOR LABORATORY USE – Certified to US standards

CLASS 8721 84 ELECTRICAL EQUIPMENT FOR LABORATORY USE – Certified to US standards

CLASS 8721 04 LABORATORY EQUIPMENT – Electrical

CLASS 8721 04 LABORATORY EQUIPMENT – Electrical

Single photon counting module SPCM-AQRH or SPCM-AQR model SPCM-AQRH-WX or SPCM-AQR-WX (where W = 1,2,3,5,4,5,6 and X = 0, 1, 2, 3, 4, 5, 6 not affecting safety certification), rated 5Vdc, 1.2A.

Single photon counting module SPCM-AQRH-WX-FC or SPCM-AQR-WX-FC model SPCM-AQRH-WX-FC or SPCM-AQR-WX-FC (where W = 1,2,3,4,5,6 and X = 0, 1, 2, 3, 4, 5, 6 not affecting safety certification), rated 5Vdc, 1.2A.

Single photon counting module SPCM-CDXXXXY (where X = can be 0000 to 9999, Y could be a letter from A to Z, not affecting safety certification), rated 5Vdc, 1.2A.

SPCM-AQRH Series

Single Photon Counting Module

Altitude of Operation: 0 – 5000 Meters.

Humidity of Operation: 15% - 95% relative humidity, non-condensing Equipment class III, measurement category I, pollution degree 2.

APPLICABLE REQUIREMENTS: CAN/CSA C22.2# 61010-1 Issue: 2012/05/11 Ed:3 SAFETY REQUIREMENTS FOR ELECTRICAL EQUIPMENT FOR MEASUREMENT, CONTROL, AND LABORATORY USE -PART 1: GENERAL REQUIREMENTS.

UL 61010-1 Issued: 2012/05/11 Ed:3 SAFETY REQUIREMENTS FOR ELECTRICAL EQUIPMENT FOR MEASUREMENT, CONTROL, AND LABORATORY USE - PART 1: GENERAL REQUIREMENTS.

This product is eligible to bear the CE mark in accordance with:

EN 61326-1:2013 Electrical equipment for measurement, control and laboratory use

EN 61010-1:2012 Safety requirements for electrical equipment for measurement, control and laboratory use

This product has been tested as per the following standards:

- Emission CISPR 11
- IEC 61000-4-2 ESD
- IEC 61000-4-3 Radiated susceptibility
- IEC 61000-4-4 Burst
- IEC 61000-4-5 Surge
- IEC 61000-4-6 Conducted susceptibility
- IEC 61000-4-11 Voltage dips and interruptions

The object of the declaration described herein is in conformity with the relevant EU legislation: EMC Directive 2004/108/EC (through April 19, 2016) and EMC Directive 2014/30/EU (from April 20, 2016).

This equipment is intended for Indoor Use Only. There is no applicable maintenance manual. The data sheet is used also as an instruction manual.

Excelitas Technologies reserves the right to make changes, improvements, modifications and corrections to its products. Excelitas Technologies reserves the right to discontinue its products. Buyers should obtain the latest information about the product before placing orders.

Single Photon Counting Module

About Excelitas Technologies

Excelitas Technologies is a global technology leader focused on delivering innovative, customized solutions to meet the detection, lighting, and other high-performance technology needs of OEM customers.

From analytical instrumentation to clinical diagnostics, medical, industrial, safety and security, and aerospace and defense applications, Excelitas Technologies is committed to enabling our customers' success in their end-markets. Excelitas Technologies has approximately 5,000 employees in North America, Europe and Asia, serving customers across the world.

Excelitas Technologies

22001 Dumberry Road
Vaudreuil-Dorion, Quebec
Canada J7V 8P7
Telephone: (+1) 450.424.3300
Toll-free: (+1) 800.775.6786
Fax: (+1) 450.424.3345
detection.na@excelitas.com

Excelitas Technologies GmbH & Co. KG

Wenzel-Jaksch-Str. 31
D-65199 Wiesbaden
Germany
Telephone: (+49) 611 492 430
Fax: (+49) 611 492 165
detection.europe@excelitas.com

Excelitas Technologies Singapore, Pte. Ltd.

8 Tractor Road
Singapore 627969
Telephone: (+65) 6775 2022
(Main number)
Telephone: (+65) 6770 4366
(Customer Service)
Fax: (+65) 6778-1752
detection.asia@excelitas.com



For a complete listing of our global offices, visit www.excelitas.com/Locations

© 2016 Excelitas Technologies Corp. All rights reserved. The Excelitas logo and design are registered trademarks of Excelitas Technologies Corp. All other trademarks not owned by Excelitas Technologies or its subsidiaries that are depicted herein are the property of their respective owners. Excelitas reserves the right to change this document at any time without notice and disclaims liability for editorial, pictorial or typographical errors.