

3.1 EPIC® D A - V I N C I H - A

Anbaugehäuse / Panel mount base / Embase encastrée

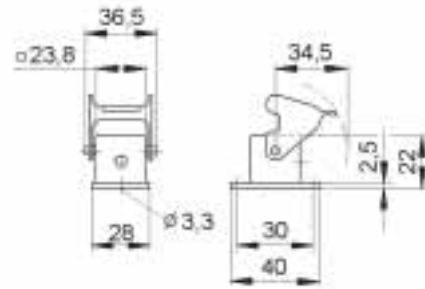

EPIC® H-A Gehäuse: Anbaugehäuse
EPIC® H-A housings: panel mount base
Boîtiers EPIC® H-A: embase encastrée

H-A 3

Artikel <i>part</i> <i>article</i>	Art.Nr. <i>part No.</i> <i>N° art.</i>	Material <i>material</i> <i>matière</i>	Farbe <i>colour</i> <i>couleur</i>	Verschraubung <i>cable gland</i> <i>presse-étoupe</i>	B	H
H-A 3 MAg	10422500	Zinkdruckguss / <i>zinc die cast</i> / <i>zinc moulé par injection</i>	grau/ <i>grey</i> / <i>grise</i>			
H-A 3 Ag	10422200	Thermoplast / <i>thermoplastic</i> / <i>plastique thermoformé</i>	schwarz/ <i>black</i> / <i>noir</i>			
H-A 3 Ag	10422000	Thermoplast / <i>thermoplastic</i> / <i>plastique thermoformé</i>	grau/ <i>grey</i> / <i>grise</i>			

Einsätze / *Inserts* / *Inserts*: 1.1: H-A 3, H-A 4 / 1.2: H-Q5 / 1.3: STA 6 / 1.8: H-D 7, H-D 8
 Deckel / *Cover* / *Couvercle*: 6.1: H-A 3

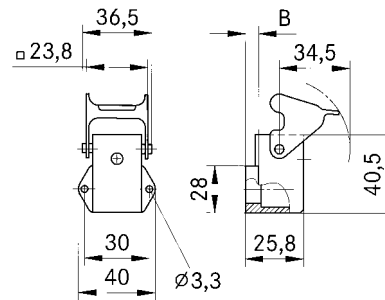

EPIC® H-A Gehäuse: Anbaugehäuse (gewinkelt)
EPIC® H-A housings: panel mount base (angled)
Boîtiers EPIC® H-A: embase encastrée (sortie latérale)

H-A 3

Artikel <i>part</i> <i>article</i>	Art.Nr. <i>part No.</i> <i>N° art.</i>	Material <i>material</i> <i>matière</i>	Farbe <i>colour</i> <i>couleur</i>	Verschraubung <i>cable gland</i> <i>presse-étoupe</i>	B	H
H-A 3 MAgs	10423500	Zinkdruckguss / <i>zinc die cast</i> / <i>zinc moulé par injection</i>	grau/ <i>grey</i> / <i>grise</i>		3,5	
H-A 3 Ags	10423100	Thermoplast / <i>thermoplastic</i> / <i>plastique thermoformé</i>	schwarz/ <i>black</i> / <i>noir</i>		3,5	
H-A 3 Ags	10423000	Thermoplast / <i>thermoplastic</i> / <i>plastique thermoformé</i>	grau/ <i>grey</i> / <i>grise</i>		3,5	

Einsätze / *Inserts* / *Inserts*: 1.1: H-A 3, H-A 4 / 1.2: H-Q5 / 1.3: STA 6 / 1.8: H-D 7, H-D 8
 Deckel / *Cover* / *Couvercle*: 6.1: H-A 3

3.1 EPIC® D A - V I N C I H - A

Anbaugehäuse / Panel mount base / Embase encastrée

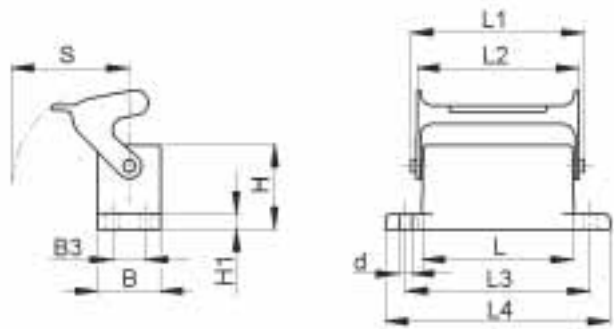

EPIC® H-A Gehäuse: Anbaugehäuse (Längsbügel)
EPIC® H-A housings: panel mount base (single locking lever)
Boîtiers EPIC® H-A: embase encastrée (simple levier)

H-A 10

Artikel part article	Art.Nr. part No. N° art.	L	L1	L2	L3	L4	B	B1	B2	B3	B4	B5	H	H1	H2	S	d
H-A 10 AG-LB	10442000	63	74,4	71,4	70	81	29,5			17,5			25	3,5		36,5	3,6

Einsätze / Inserts / Inserts: 1.1: H-A 10 / 1.3: STA 14 / 1.8: H-D 15
 Deckel / Cover / Couvercle: 6.1: H-A 10

H-A 16

Artikel part article	Art.Nr. part No. N° art.	L	L1	L2	L3	L4	B	B1	B2	B3	B4	B5	H	H1	H2	S	d
H-A 16 AG-LB	10462000	79	90,4	87,8	86	96	29,5			17,5			25	3,5		36,5	3,6

Einsätze / Inserts / Inserts: 1.1:H-A 16 / 1.3: STA 20 / 1.8: H-D 25
 Deckel / Cover / Couvercle: 6.1: H-A 16

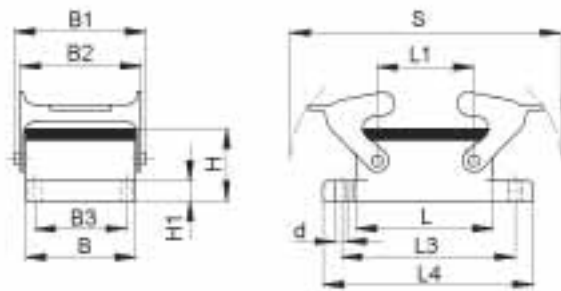

EPIC® H-A Gehäuse: Anbaugehäuse (Querbügel)
EPIC® H-A housings: panel mount base (double locking lever)
Boîtiers EPIC® H-A: embase encastrée (double levier)

H-A 32

Artikel part article	Art.Nr. part No. N° art.	L	L1	L2	L3	L4	B	B1	B2	B3	B4	B5	H	H1	H2	S	d
H-A 32 AG	10472000	82	49,6		92	102	56	70,8	66	42			25,4	4		124,5	4,3

Einsätze / Inserts / Inserts: 1.1: H-A 32 / 1.3: 2 x STA 20 / 1.8: H-D 50
 Deckel / Cover / Couvercle: 6.1: H-A 32

H-A 48

Artikel part article	Art.Nr. part No. N° art.	L	L1	L2	L3	L4	B	B1	B2	B3	B4	B5	H	H1	H2	S	d
H-A 48 AG	10625500	93,5	64,5		110	124	79	93,8	87,8	65			30,3	5		136,5	5,5

Einsätze / Inserts / Inserts: 1.1:H-A 48

3.1 EPIC® D A - V I N C I H - A

Sockelgehäuse / Surface mount base / Embase en saillie



PG / M

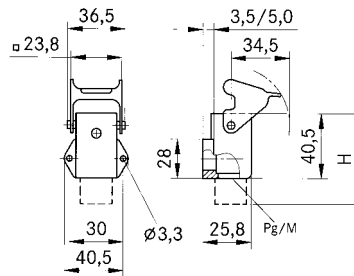

EPIC® H-A Gehäuse: Sockelgehäuse

EPIC® H-A housings: surface mount base

Boîtiers EPIC® H-A: embase en saillie

H-A 3

Artikel part article	Art.Nr. part No. N° art.	PG	M	Material material matière	Farbe colour couleur	Verschraubung cable gland presse-étoupe	B	H
H-A 3 MAgsv	10512700	11		Zinkdruckguss / zinc die cast / zinc moulé par injection	grau/grey/grise		3,5	51,5
H-A 3 Agsv	10424000	11		Thermoplast / thermoplastic / plastique thermoformé	grau/grey/grise		5,0	56
H-A 3 MAgsv	10424500	11		Zinkdruckguss / zinc die cast / zinc moulé par injection	grau/grey/grise	●	3,5	57,5
H-A 3 Agsv	10424200	11		Thermoplast / thermoplastic / plastique thermoformé	grau/grey/grise	●	5,0	65
H-A 3 MAgsv M20	19512700		20	Zinkdruckguss / zinc die cast / zinc moulé par injection	grau/grey/grise		3,5	54,5
H-A 3 Agsv M20	19421900		20	Thermoplast / thermoplastic / plastique thermoformé	grau/grey/grise	●	5,0	56
H-A 3 MAgsv M20	19424500		20	Zinkdruckguss / zinc die cast / zinc moulé par injection	grau/grey/grise	●	3,5	60,5

Einsätze / Inserts / Inserts: 1.1: H-A 3, H-A 4 / 1.2: H-Q5 / 1.3: STA 6 / 1.8: H-D 7, H-D 8

Deckel / Cover / Couvercle: 6.1: H-A 3

Kabelverschraubung / Cable gland / Presse-étoupe: 5.1: Metr. & PG

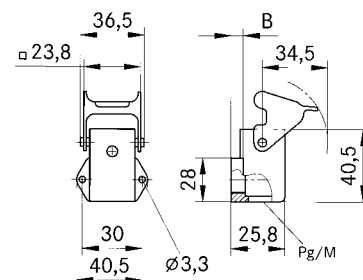

EPIC® H-A 3 Gehäuse: Sockelgehäuse mit offenem Boden

EPIC® H-A 3 housings: surface mount base with open bottom

Boîtiers EPIC® H-A 3: embase en saillie avec sol ouvert

H-A 3

Artikel part article	Art.Nr. part No. N° art.	M	Material material matière	Farbe colour couleur	Verschraubung cable gland presse-étoupe	B	H
H-A 3 MAgsv M20	19517200	20	Zinkdruckguss / zinc die cast / zinc moulé par injection	grau/grey/grise		3,5	
H-A 3 Agsv M20	19515200	20	Thermoplast / thermoplastic / plastique thermoformé	grau/grey/grise		5,0	

3.1 EPIC® D A - V I N C I H - A

Sockelgehäuse / Surface mount base / Embase en saillie



PG / M

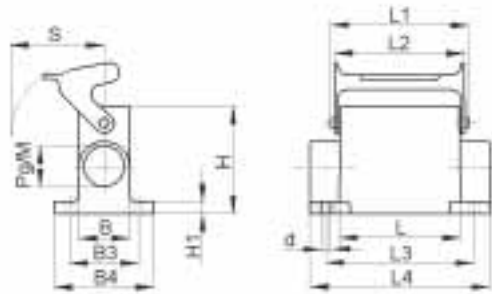

EPIC® H-A Gehäuse: Sockelgehäuse (1 Kabeleingang, Längsbügel)

EPIC® H-A housings: surface mount base (1 cable entry, single locking lever)

Boîtiers EPIC® H-A: embase en saillie (1 entrée de câble, simple levier)

H-A 10

Artikel part article	Art.Nr. part No. N° art.	PG	M	L	L1	L2	L3	L4	B	B1	B2	B3	B4	B5	H	H1	H2	S	d
H-A 10 SGR-LB 16	10448100	16		63	74,4	71,4	48	80	29,5			40	50		57	3,5		36,5	4,5
H-A 10 SGR-LB 21	10448000	21																	
H-A 10 SGR-LB M20	19448100		20	63	74,4	71,4	48	80	29,5			40	50		57	3,5		36,5	4,5
H-A 10 SGR-LB M25	19448000		25																

Einsätze / Inserts / Inserts: 1.1: H-A 10 / 1.3: STA 14 / 1.8: H-D 15

Deckel / Cover / Couvercle: 6.1: H-A 10

Kabelverschraubung / Cable gland / Presse-étoupe: 5.1: Metr. & PG

H-A 16

Artikel part article	Art.Nr. part No. N° art.	PG	M	L	L1	L2	L3	L4	B	B1	B2	B3	B4	B5	H	H1	H2	S	d
H-A 16 SGR-LB 16	10567100	16		79	90,4	87,8	64	96	29,5			40	50		57	3,5		36,5	4,5
H-A 16 SGR-LB 21	10567000	21																	
H-A 16 SGR-LB M20	19567100		20	79	90,4	87,8	64	96	29,5			40	50		57	3,5		36,5	4,5
H-A 16 SGR-LB M25	19567000		25																

Einsätze / Inserts / Inserts: 1.1: H-A 16 / 1.3: STA 20 / 1.8: H-D 25

Deckel / Cover / Couvercle: 6.1: H-A 16

Kabelverschraubung / Cable gland / Presse-étoupe: 5.1: Metr. & PG

3.1 EPIC® D A - V I N C I H - A

Sockelgehäuse / Surface mount base / Embase en saillie



PG / M

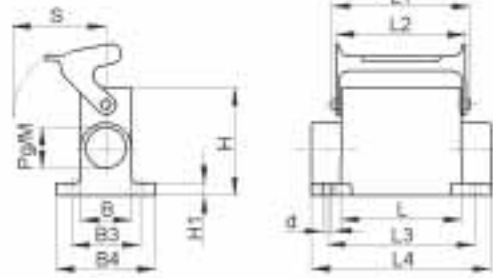

EPIC® H-A Gehäuse: Sockelgehäuse (2 Kabeleingänge, Längsbügel)

EPIC® H-A housings: surface mount base (2 cable entries, single locking lever)

Boîtiers EPIC® H-A: embase à encastrer (2 entrées de câble, simple levier)

H-A 10

Artikel part article	Art.Nr. part No. N° art.	PG	M	L	L1	L2	L3	L4	B	B1	B2	B3	B4	B5	H	H1	H2	S	d
H-A 10 SGRL-LB 16	10450100	16		63	74,4	71,4	48	80	29,5			40	50		57	3,5		36,5	4,5
H-A 10 SGRL-LB M20	19450100		20	63	74,4	71,4	48	80	29,5			40	50		57	3,5		36,5	4,5

Einsätze / Inserts / Inserts: 1.1: H-A 10 / 1.3: STA 14 / 1.8: H-D 15

Deckel / Cover / Couvercle: 6.1: H-A 10

Kabelverschraubung / Cable gland / Presse-étoupe: 5.1: Metr. & PG

H-A 16

Artikel part article	Art.Nr. part No. N° art.	PG	M	L	L1	L2	L3	L4	B	B1	B2	B3	B4	B5	H	H1	H2	S	d
H-A 16 SGRL-LB 16	10568100	16		79	90,4	87,8	64	96	29,5			40	50		57	3,5		36,5	4,5
H-A 16 SGRL-LB 21	10568000	21		79	90,4	87,8	64	96	29,5			40	50		57	3,5		36,5	4,5
H-A 16 SGRL-LB M20	19568100		20	79	90,4	87,8	64	96	29,5			40	50		57	3,5		36,5	4,5
H-A 16 SGRL-LB M25	19568000		25	79	90,4	87,8	64	96	29,5			40	50		57	3,5		36,5	4,5

Einsätze / Inserts / Inserts: 1.1: H-A 16 / 1.3: STA 20 / 1.8: H-D 25

Deckel / Cover / Couvercle: 6.1: H-A 16

Kabelverschraubung / Cable gland / Presse-étoupe: 5.1: Metr. & PG

3.1 EPIC® D A - V I N C I H - A

Sockelgehäuse / Surface mount base / Embase en saillie



PG / M

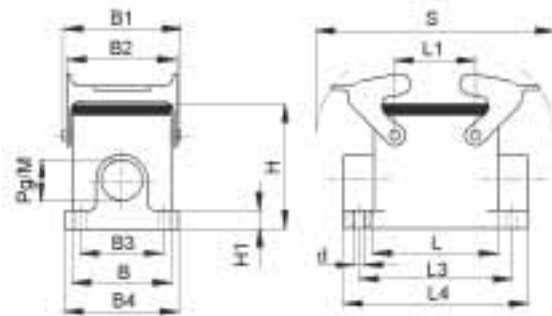

EPIC® H-A Gehäuse: Sockelgehäuse (1 Kabeleingang, Querbügel)

EPIC® H-A housings: surface mount base (1 cable entry, double locking lever)

Boîtiers EPIC® H-A: embase en saillie (1 entrée de câble, double levier)

H-A 32

Artikel part article	Art.Nr. part No. N° art.	PG	M	ZW	L	L1	L2	L3	L4	B	B1	B2	B3	B4	B5	H	H1	H2	S	d
H-A 32 SGR 21	10474000	21		●	82	49,6		94	106	56	70,8	66	46	57		75	4		124,5	5,5
H-A 32 SGR 29	10474100	29		●																
H-A 32 SGR M25	19474000		25	●																
H-A 32 SGR M32	19474100		32	●	82	49,6		94	106	56	70,8	66	46	57		75	4		124	5,5
H-A 32 SGR M40	79505800		40																	

Einsätze / Inserts / Inserts: 1.1: H-A 32 / 1.3: 2 x STA 20 / 1.8: H-D 50

Deckel / Cover / Couvercle: 6.1: H-A 32

Kabelverschraubung / Cable gland / Presse-étoupe: 5.1: Metr. & PG

H-A 48

Artikel part article	Art.Nr. part No. N° art.	PG	M	ZW	L	L1	L2	L3	L4	B	B1	B2	B3	B4	B5	H	H1	H2	S	d
H-A 48 SGR 29	10633800	29		●																
H-A 48 SGR M32	19633800		32	●	93,5	64,5		112	124,5	79	93,8	87,8	67	81		72	5		136,5	5,5
H-A 48 SGR M40	19638600		40																	

Einsätze / Inserts / Inserts: 1.1: H-A 48

Kabelverschraubung / Cable gland / Presse-étoupe: 5.1: Metr. & PG