

SCA3000 Assembly Instructions

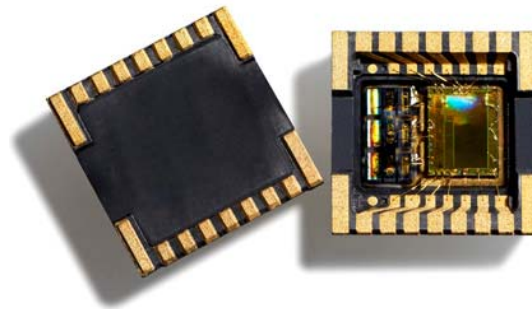

SCA3000 Series
3-axis accelerometer

TABLE OF CONTENTS

1	Objective	3
2	VTI's Molded Interconnection Device Package (MID)	3
3	SCA3000 Package Outline and Dimensions	5
4	Tape and reel specifications	6
5	Printed Wiring Board (PWB) Level Guidelines	8
5.1	Land Pad Design.....	8
5.2	Solder Paste	8
5.3	Stencil	9
5.4	Paste Printing.....	9
5.5	Component Picking	9
5.6	Component Placement.....	9
5.7	Reflow Soldering.....	9
5.8	Moisture sensitivity level (MSL) classification.....	10
5.9	Inspection.....	10
6	Rework Guidelines	12
7	Hand Soldering Guidelines	12
8	Environmental Aspects	13
9	References	14
10	Document Revision History	14

1 Objective

This document describes guidelines for Printed Wiring Board (PWB) design and assembly of the SCA3000 Component. It aims to help customers achieve the optimum soldering process. It should be emphasized that this document serves only as a design guideline to help develop the optimal assembly conditions. It is essential that users also use their own manufacturing practices and experience to be able to fulfill the needs of varying end-use applications.

2 VTI's Molded Interconnection Device Package (MID)

The housing of the SCA3000 component is relatively new packaging concept, which is called a molded interconnection device (MID), which is a modified Dual Flat-pack No-lead package (DFN). The MID housing is leadless component as well as DFN package. The SCA3000 component is a surface mount plastic package with leads located at the bottom of the package, see picture 1.

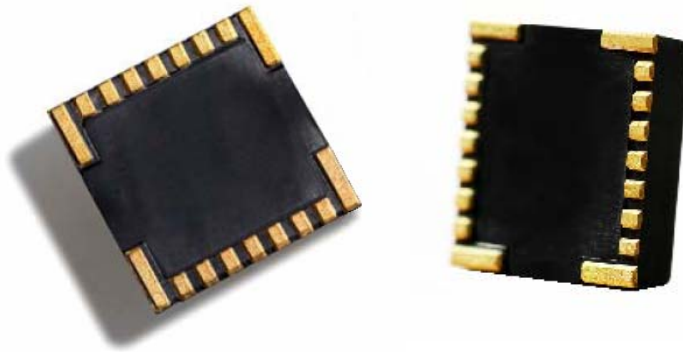

Figure 1. 3D pictures of the SCA3000 component. The SCA3000 component leads are located at the bottom of the package.

MID-technology offers a variety of benefits including reduced lead inductance, a small sized "near chip scale" footprint, thin profile, and low weight. The MID component is an injection molded plastic substrate, and the conductive circuit pattern is manufactured on its surface. The SCA3000 component housing is manufactured by the LDS (Laser Direct Structuring) MID-process. The process flow of LDS - MID package is presented in figure 2.

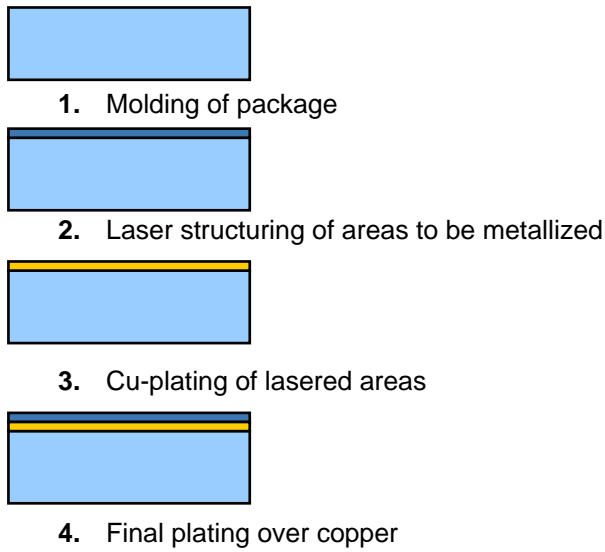

Figure 2. Manufacturing process for the LDS – Molded Interconnect Device.

The solder pads of a MID package are rougher than the pads of traditional lead frame packages. A photo of a MID package solder pad is presented in figure 3. The rougher surface of the solder pad can produce more voids in the solder joints, which is also observed in guidelines of this technical note.

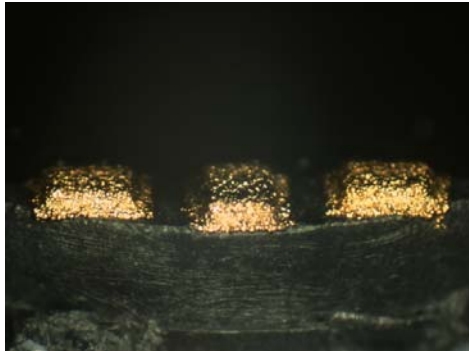

Figure 3. Photo of a MID solder pad. Surface is rougher than with traditional SMD components.

Because the MID platform represents the latest in surface mount packaging technology, it is important that the design of the printed circuit board, as well as the assembly process, follows the suggested guidelines outlined in this document.

3 SCA3000 Package Outline and Dimensions

The outline and dimensions for the SCA3000 MID package are presented in figure 4.

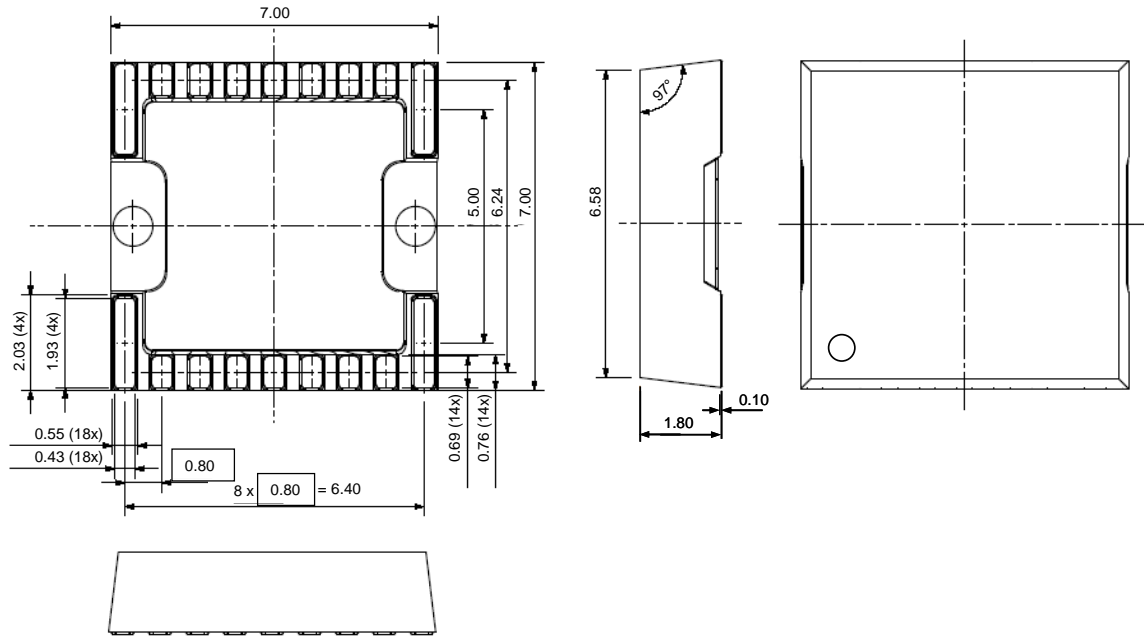

Figure 4. Outline and dimensions of the SCA3000 component.

4 Tape and reel specifications

Packing tape dimensions, unreeling direction and SCA3000 component orientation are presented in figure 5, table 1 and table 2 below (dimensions are in millimeters [mm]).

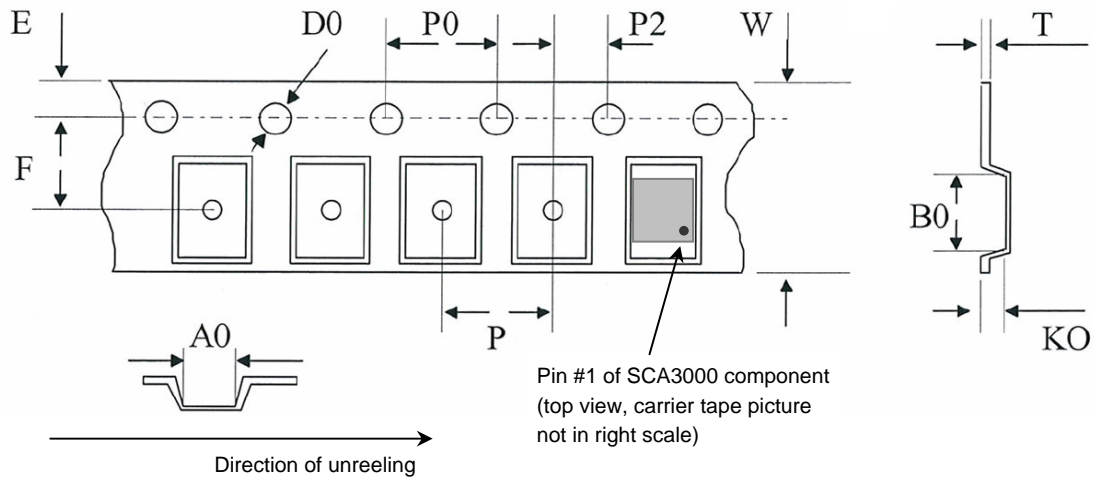

Figure 5. SCA3000 packing tape and component orientation on tape.

Table 1. SCA3000 packing tape pocket dimensions [mm].

A0	B0	KO
7.2 ±0.1	7.4 ±0.1	1.9 ±0.1

Table 2. Dimensions for SCA3000 packing tape [mm].

Parameter	Min	Nominal	Max
F	11.40	11.50	11.60
E	1.65	1.75	1.85
W	23.90	24.00	24.30
P2	1.90	2.00	2.10
P0	3.90	4.00	4.10
10P0	39.80	40.00	40.20
D0	1.50	1.50	1.60
D1	1.50	1.50	1.75
T	0.272	0.292	0.312
P	11.90	12.00	12.10

The reel dimensions are presented in figure 6 and table 3 below (dimensions are in millimeters [mm]).

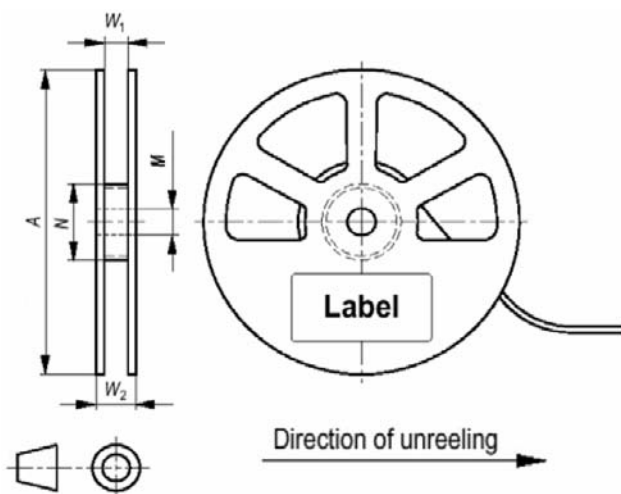

Figure 6. Reel dimensions.

Table 3. SCA3000 Packing reel dimensions [mm].

A	N _{min}	W1	W _{2max}	M
330	102	24.4 ±2	30.4	∅ 13.0 ±0.25

Both tape and reel are ESD materials and they are suitable for baking for 24 hours at +125°C.

5 Printed Wiring Board (PWB) Level Guidelines

5.1 Land Pad Design

Two types of land patterns are used for surface mount packages:

- 1) Non-Solder Mask Defined Pads (NSMD)
- 2) Solder Mask Defined Pads (SMD).

NSMD pads have an opening which is larger than the pad itself, and SMD pads have a solder mask opening that is smaller than the metal pad on PWB. NSMD is preferred since the copper etching process has tighter process control compared to the solder mask process. The specific PWB land pattern for the SCA3000 component is presented in figure 7.

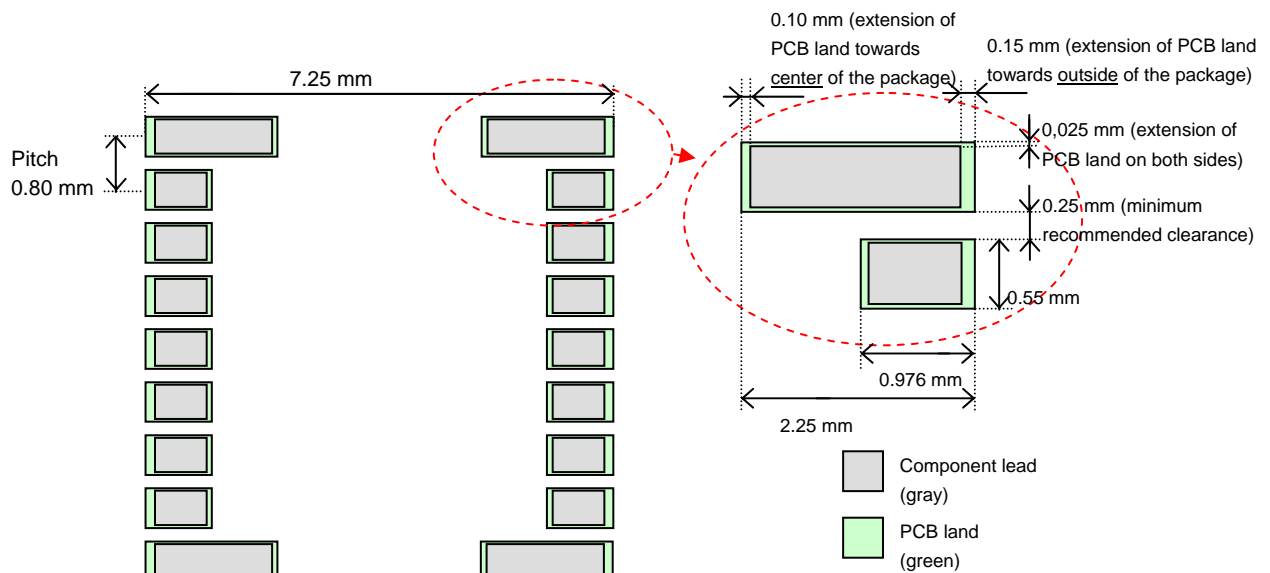

Figure 7. Recommended PWB pad layout for SCA3000 component.

VTI's SCA3000 packages can be soldered on commonly used substrates, e.g. FR-4, ceramic etc. The pad metallization should be solder wettable in order to assure good quality solder joints. For fine pitch assembly, the quality of plating is important. Generally used circuit board finishes for fine pitch SMD soldering are NiAu, OSP, Electroless-Ag and Electroless-Sn.

5.2 Solder Paste

The SCA3000 package can be soldered with lead-free SAC (tin-silver-copper) solder. The SAC solder paste composition should be near eutectic. The melting point of lead-free SAC solder can vary between 217–221°C, depending on the composition of solder alloy. In order to guarantee full RoHS compatibility lead-free solder should be used for the soldering of VTI's SCA3000 component. Also traditional eutectic SnPb solder can be used for soldering the SCA3000 packages if a lead-free process is not required. With the eutectic SnPb solder, the melting point is 183°C.

A no-clean solder paste is recommended, since the SCA3000 package has very small stand off and the effectiveness of cleaning process is therefore low. **Ultrasonic agitation wash is not allowed.** The solder paste which is used must be suitable for printing it through the stencil aperture dimensions. Type 3 paste is recommended (grain size 25-45µm).

5.3 Stencil

The solder paste is applied onto the PWB by using stencil printing. The stencil thickness and aperture determines the precise volume of solder paste deposited onto the land pattern. Stencil alignment accuracy and consistent solder volume transfer are important parameters for achieving uniform reflow soldering results. Too much solder paste can cause bridging and too little solder paste can cause insufficient wetting. Generally the stencil thickness needs to be matched to the needs of all components on the PWB.

For the SCA3000 MID-package the recommended stencil thickness is 5mils (127µm).

Stencil apertures in general should be 1:1 to PWB pad sizes, or stencil apertures could even be reduced by 1mil (25.4µm) from all sides in regard to the PWB land pad size. This reduction of aperture size can reduce bridging between solder joints.

5.4 Paste Printing

The paste printing speed should be adjusted according to the solder paste specifications. It is recommended that care be taken during paste printing in order to ensure correct paste amount, shape, position, and other printing characteristics. Neglecting any of these can cause open solder joints, bridging, solder balling, or other unwanted soldering results.

5.5 Component Picking

The SCA3000 component can be picked from the carrier tape using either vacuum assist or mechanical type pick heads. Typically a vacuum nozzle is used. Pick up nozzles are available in various sizes and shapes to suit a variety of different component geometries. It is recommended that different pick up nozzles are tested to find the best one. The polarity of the part must be assured in taping process. The polarity of the part on tape is presented in figure 5 on page 4.

5.6 Component Placement

SCA3000 MID packages must be placed onto PWB accurately according to their geometry. Positioning the packages manually is not recommended. Placement should be done with modern automatic component pick & place machinery using vision systems.

Recognition of the packages automatically by a vision system enables correct centering of packages.

5.7 Reflow Soldering

A forced convection reflow oven is recommended to be used for soldering SCA3000 components. IR-based reflow ovens are not generally suitable for lead-free soldering. Figure 8 presents a general forced convection reflow solder profile and it also shows the typical phases of a reflow process. The reflow profile used for soldering the SCA3000 package should always follow the solder paste manufacturer's specifications and recommended profile.

The reflow profile used for soldering the SCA3000 MID package should follow the solder paste manufacturer's specifications and recommended profile. The typical ramp-up rate is 3°C/second max. For lead-free soldering with SnAgCu solder, the pre-heat temperature zone is ~ 150°C-200°C and should last for ~ 60-180 seconds. Time above the liquidus temperature (~217°C) should be ~ 60-150 seconds. The reflow max. peak temperature should not exceed 260°C. Temperature within actual peak temperature is typically ~20-40 seconds. The ramp down rate should be 6°C/second max.

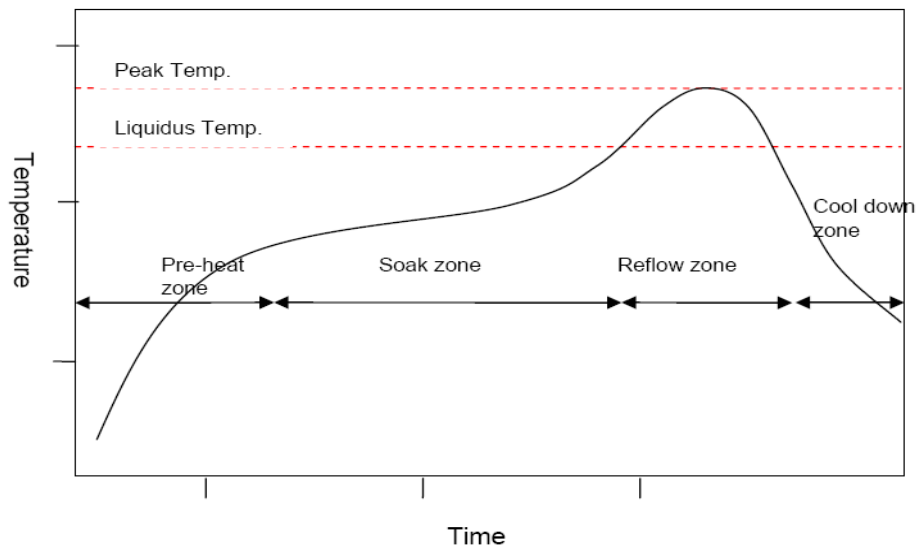

Figure 8. Typical convection reflow soldering phases and profile.

The process window for lead-free soldering is narrower than for traditional eutectic SnPb solders. Thus, caution has to be taken care when adjusting the reflow profiles. The reflow profile should be measured using a thermo-couple measurement system. It is recommended that at least three thermo-couples are used, depending on the application. As a general guide, one thermo-couple should be placed under a component having the largest thermal mass, one next to the smallest component, one should be in contact with SCA3000 component's solder joint, and others to the appropriate spots on a circuit board, e.g. corner, center, bottom of the board etc. The reflow profile should be adjusted according to the measured data so that each solder joint experiences an optimal reflow profile. The temperature gradient should be as small as possible across the circuit board. Extreme caution has to be taken if the circuit board contains components with vastly different thermal masses.

5.8 Moisture sensitivity level (MSL) classification

The Moisture Sensitivity Level of the SCA3000 component is Level 3 according to the IPC/JEDEC J-STD-020C. The part is delivered in a dry pack. The manufacturing floor time (out of bag) at the customer's end is 168 hours. Maximum soldering peak temperature for the SCA3000 is 260°C/40sec, measured from the package body.

5.9 Inspection

Optical and visual inspection of solder joints can be done only partly, since the solder joints are located underneath the component itself. Therefore inspection of the solder joints with conventional AOI (automatic optical inspection) system is not recommended. Figure 9 show photos of how the soldered component on PWB looks from different directions.

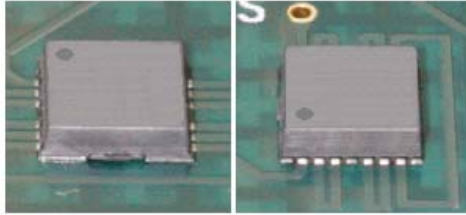

Figure 9. Solder pads, component leads and the solder joints are located under the component itself.

X-ray inspection is a recommended inspection method for being able to check the complete solder joint area for solder bridges or short-circuits between solder pads. The X-ray inspection systems vary from manual to fully automated optical inspection systems. X-ray can be used for sample based process control, but it can also be implemented as an automatic in-line control. X-ray inspection can also be used to establish and optimize the component assembly process parameters.

Cross-sectional analysis is also an approved method to inspect how well solder has wetted the pads of component. Cross-sectional analysis is not used for production inspection, but if required, it can be used to establish and optimize the component assembly process parameters. Cross-sectioning is a destructive inspection method. An example of a SCA3000 solder joint cross-section is presented in figure 10.

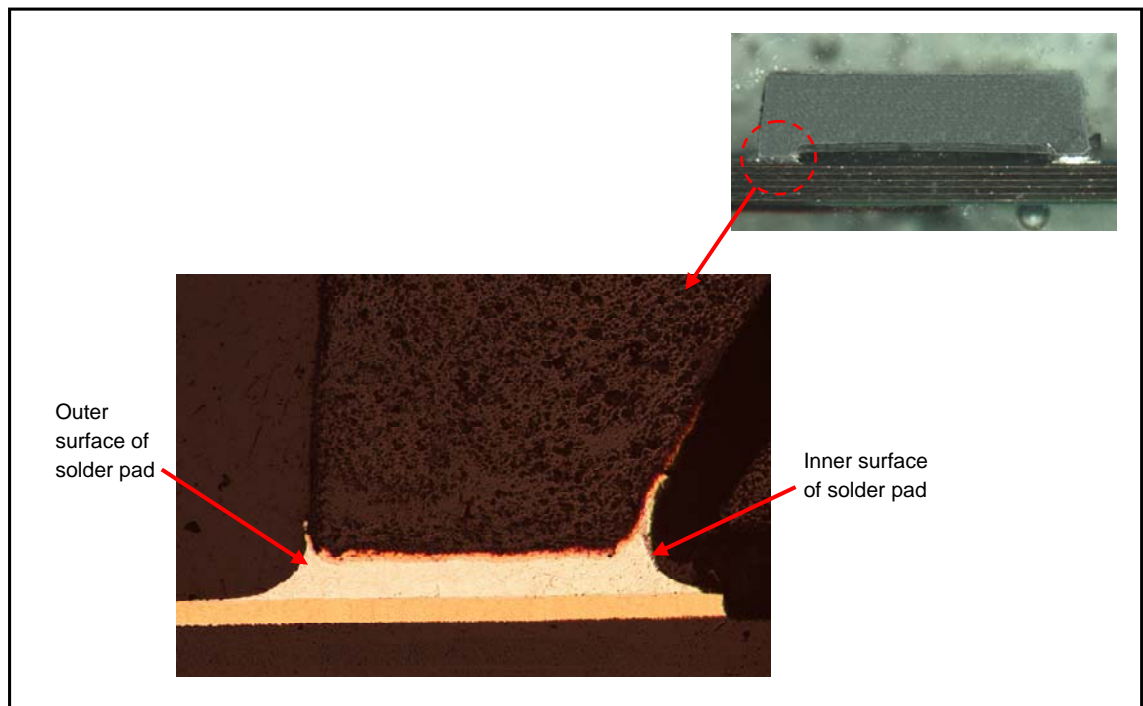

Figure 10. Wetting of solder is different on the inner and outer surface of the solder pad.

6 Rework Guidelines

T.B.D.

7 Hand Soldering Guidelines

Hand soldering of the SCA3000 MID package is not recommended. For proto-uses of the SCA3000 component, VTI can provide pre-assembled component on a PWB.

For hand soldering of the SCA3000 component, VTI recommends eutectic tin-lead solder paste due to the lower melting point compared to lead-free solder pastes.

Soldering is possible by applying solder paste onto PWB land pads and *then* using reflow heating or soldering iron to melt the paste and achieve the soldered joint.

To make the manual hand soldering with soldering iron easier, VTI recommends increasing the PWB land pads length toward the outside of the package by up to 1mm, as shown in Figure 11 below. This extra area is helpful when soldering iron is being used. The hand soldering method is presented in more detail below.

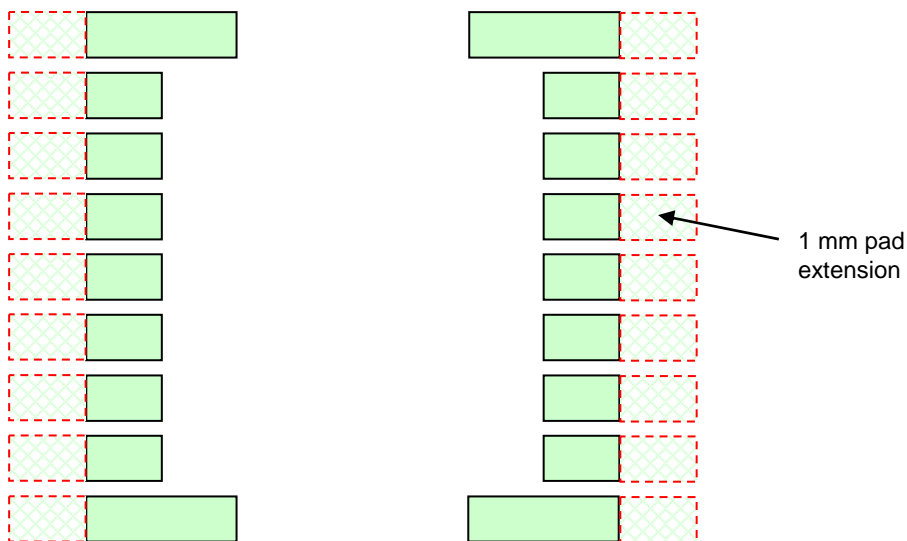

Figure 11. Recommended PWB land pad lengthening for and soldering.

Narrow signal traces to component PWB soldering pads to optimize the conduction of heat to solder paste and component leads. See figure 12 for details.

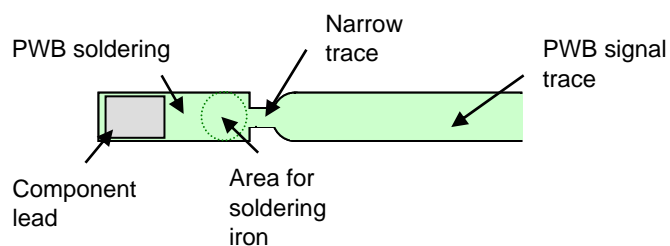

Figure 12. Narrowed PWB signal traces and use of soldering iron.

1. Apply the solder paste onto the PWB land pads. The paste can be applied by two different methods.
 - Manual solder paste printing through a stencil with normal openings designed for the SCA3000 component.
 - Needle dispensing of solder paste manually onto the PWB pads. VTI recommends use of a microscope in manual solder paste dispensing. Dispensing needle tip size can be 0.12"-0.16".

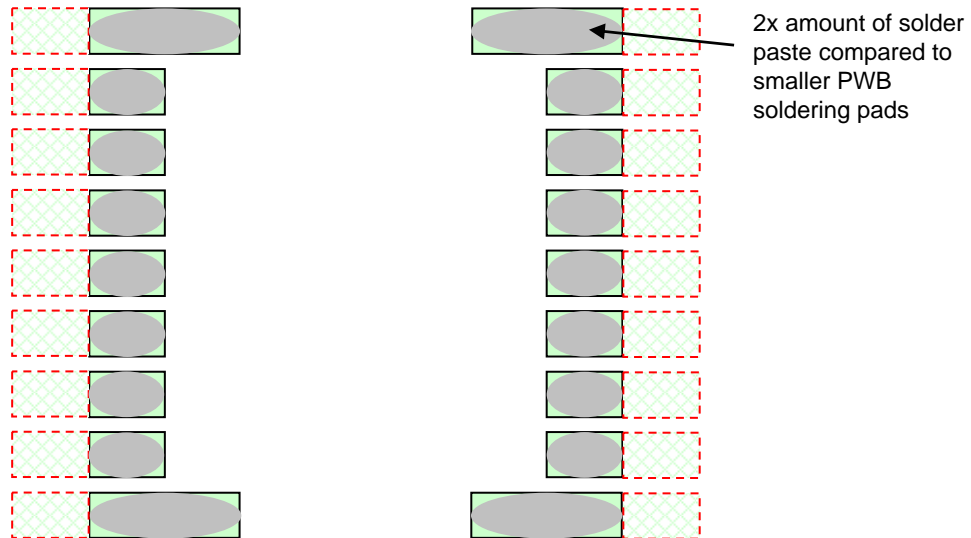

Figure 13: Solder paste (grey) on PWB land pads.

2. Place the component gently on top of the solder paste. To avoid solder bridging, push only very gently on top of the component.
3. **i)** Melt the solder paste by putting the part through reflow oven **or ii)** by using soldering iron. When using soldering iron, do not touch the package plastic body, soldering iron should touch only the extension in the PWB's land pad through that the heat should be conducted to melt the solder paste and then form the solder joint to the component lead. See figure 11 above for details.

8 Environmental Aspects

VTI Technologies respects environmental values and thus its MID packaged pressure sensors are lead-free and RoHS compatible. VTI Technologies' sensors should be soldered with lead-free solders in order to guarantee full RoHS compatibility.

9 References

JEDEC / Electronic Industries Alliance, Inc. Moisture/ReflowSensitivity Classification for Non-Hermetic Solid State Surface Mount Devices (J-STD-020C).

10 Document Revision History

Version	Date	Change Description
Rev. A	30.06.2006	First release