

POLIAMMIDE 6

- Ruota in poliammide 6 di prima scelta.
- Elevata resistenza agli urti, all'abrasione e alle sostanze corrosive; facilità di pulizia.
- Temperatura di impiego: -30°C / +80°C
- Mozzo con: cuscinetti a sfere di precisione, schermati; cuscinetto a rullini standard o inox; foro passante.

POLYAMIDE 6

- Highest quality polyamide 6 wheel.
- Minimal rolling resistance; excellent resistance to shocks, abrasion and corrosion; easy to clean.
- Temperature range: -30°C / +80°C (-22°F / +176°F).
- Hub with: shielded precision ball bearings; standard or stainless steel roller bearing; plain bore.

POLYAMID 6

- Rad aus Polyamid 6 - 1. Wahl.
- Hohe Stossfestigkeit; abrieb- und korrosionsfest; niedriger Rollwiderstand; leichte Reinigung.
- Arbeitstemperatur: -30°C / +80°C.
- Lagerung: abgeschirmte Präzisions-Rillenkugellager; standard oder rostfreies Rollenkorblager; Gleitlager.

**POLYAMIDE 6**

- Roue en polyamide 6 premier choix.
- Excellent roulage; élevée résistance aux chocs, à l'abrasion et à la corrosion; facilité de nettoyage.
- Température d'emploi : -30°C / +80°C (-22°F / +176°F).
- Moyeu avec: roulements à billes de précision, protégés; roulement à rouleaux inox ou standard; alésage lisse.

POLIAMIDA 6

- Rueda de poliamida 6 de primera calidad.
- Elevada resistencia a los golpes, a la abrasión y a las sustancias corrosivas; se limpia fácilmente.
- Temperatura de empleo : -30°C / +80°C (-22°F / +176°F).
- Cubo con: cojinetes a bolas de precisión, protegidos; cojinete a rodillos standard o inox; agujero liso.

D	80	80	100	100	100	100	100	125	125	125	125	125	150	150	150	150	175	175	200	200	200	200	250
E	30	40	30	37	37	40	40	30	40	45	45	40	48	48	50	50	50	50	50	50	50	50	60



CUSCINETTI A SFERE DI PRECISIONE - PRECISION BALL BEARINGS - PRÄZISIONS-RILLENKUGELLAGER
ROULEMENTS À BILLES DE PRÉCISION - COJINETES A BOLAS DE PRECISION

Art. N.	4001	4071	4002	18005	18006	4072	-	-	4074	18008	18009	4004	18011	18012	4006	4005	4007	4006	18017	18018	4009
d	15	15	15	15	20	15	-	-	15	15	20	20	20	25	20	25	20	25	20	25	25
s	35	35	35	35	42	35	-	-	35	35	42	47	47	52	47	52	47	52	52	52	52
t	12,2	12,2	12,2	12,2	15	12,2	-	-	12,2	12,2	15	17	17	17	17	17	17	17	17	17	17
V	38	38	38	38	34	38	-	-	48	48	44	44	54	56	54	56	54	56	56	56	56
L	40	40	40	40	40	40	-	-	50	50	50	50	60	60	60	60	60	60	60	60	60
M	47	47	48	56	56	48	-	-	50	58	58	63	70	70	69	69	63	71	78	78	82
Kg.	150	200	175	450	450	250	-	-	300	700	700	400	900	900	500	500	600	600	1200	1200	1400

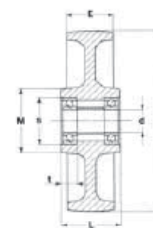

CUSCINETTO A RULLINI STANDARD O INOX - STANDARD OR STAINLESS STEEL ROLLER BEARING - STANDARD ODER ROSTFREIES ROLLENKORBLAGER - ROULEMENT À ROULEAUX STANDARD OU INOX - COJINETE A RODILLOS STANDARD O INOX

Art. N.	4011	4061	4012	-	-	4062	4410	4063	4013	-	-	4014	-	-	4018	4015	4017	4016	-	-	4019	STANDARD
Art. N.	4011/x	4061/x	4012/x	-	-	4062/x	-	4063/x	4013/x	-	-	4014/x	-	-	4018/x	4015/x	4017/x	4016/x	-	-	4019/x	INOX
d	15	15	15	-	-	15	15	15	20	-	-	20	-	-	20	25	20	25	-	-	25	
L	40	40	40	-	-	40	45	40	50	-	-	50	-	-	60	60	60	60	-	-	74	
M	37	47	38	-	-	48	35	32	43	-	-	49	-	-	55	55	57	57	-	-	68	
Kg.	150	200	175	-	-	250	200	250	300	-	-	400	-	-	500	500	600	600	-	-	1200	

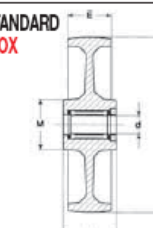

FORO PASSANTE - PLAIN BORE - GLEITLAGER - ALÉSAGE LISSE - AGUJERO LISO

Art. N.	4021	4091	4022	18080	18081	4092	4415	4093	4023	18083	18084	4024	18086	18087	4028	4025	4027	4026	18092	18093	4029
d	15	15	15	15	20	15	15	15	20	15	20	20	20	25	20	25	20	25	20	25	25
L	40	40	40	40	40	40	45	40	50	50	50	50	60	60	60	60	60	60	60	60	74
M	28	29	29	36	36	29	35	32	36	38	38	37	45	45	44	44	46	46	49	49	55
Kg.	150	200	175	450	450	250	200	250	300	700	700	400	900	900	500	500	600	600	1200	1200	1200

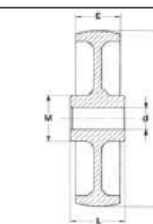

POLINYL + INOX 20

INOX - STAINLESS - ROSTFREI - INOX - INOX



pag. 13
Art. N.+ 'FR'



	D	80	100	100	125	125	125	150	150	175	200
	E	30	30	40	30	40	40	40	40	50	50

SUPPORTI GIREVOLI - SWIVEL CASTORS - LENKROLLEN - ROULETTES PIVOTANTES - CONJUNTOS GIRATORIOS

Art. N.	17102	17105	17104	17106	17107	17108	17110	17111	17114	17117		
d	15	15	15	15	20	20	20	20	20	20		
Art. N.	17127	17130	17129	17131	17132	17133	17135	17136	17139	17142		
d	15	15	15	15	20	20	20	20	20	20		

SUPPORTI FISSI - FIXED CASTORS - BOCKROLLEN - ROULETTES FIXES - CONJUNTOS FIJOS

Art. N.	17152	17155	17154	17156	17157	17158	17160	17161	17164	17167		
d	15	15	15	15	20	20	20	20	20	20		
Art. N.	17177	17180	17179	17181	17182	17183	17185	17186	17189	17192		
d	15	15	15	15	20	20	20	20	20	20		

SUPPORTI GIREVOLI A FORO - SWIVEL CASTORS WITH BOLT HOLE - LENKROLLEN MIT RÜCKENLOCH
CHAPES PIVOTANTES A Oeil - SOPORTES GIRATORIOS CON TALADRO PASADOR

Art. N.	17202HA	17205HA	17204HC	17206HA	-	17206HC	-	17211HC	17214HE	17217HE		
Art. N.	17202HB	17205HB	17204HD	17206HB	-	17206HD	-	17211HD	17214HF	17217HF		
d	15	15	15	15	-	20	-	20	20	20		
Art. N.	17227HA	17230HA	17229HC	17231HA	-	17233HC	-	17236HC	17239HE	17242HE		
Art. N.	17227HB	17230HB	17229HD	17231HB	-	17233HD	-	17236HD	17239HF	17242HF		
d	15	15	15	15	-	20	-	20	20	20		

DATI TECNICI - TECHNICAL DATA - TECHNISCHE DATEN - DONNÉES TECHNIQUES - DATOS TECNICOS

	H	106	128	129	154	160	160	181	181	216	240	
	AxB	102x83	102x83	102x83	102x83	102x83	135x110	102x83	135x110	135x110	135x110	
	axb	80x80	80x60	80x60	80x60	80x60	105x80	80x60	105x80	105x80	105x80	
	g	8	8	8	8	8	10	8	10	10	10	
	g	HA=10 / HB=12				HC=12 / HD=14			HE=12 / HF=16			
	F	33	37	46	40	49	49	51	51	57	59	
	U	40	40	50	40	50	50	50	50	60	60	
	FR	FR	FR	FR	FR	FR	FR	FR	FR	FR	FR	
	Kg.	150	150	250	150	250	250	250	250	370	370	

INOX 20

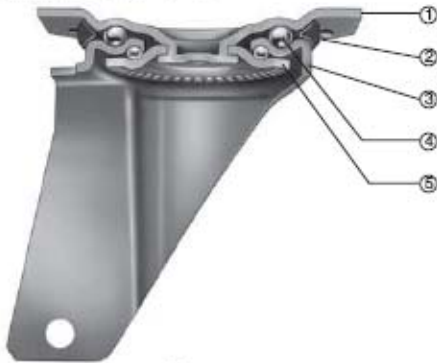

SUPPORTI MEDI INOX 20 A PIASTRA

- Finitura: lucidatura
- 1) Piastra d'attacco con perno preformato in lamiera inox AISI 304 stampata.
- 2) Anello parapolvere in materiale termoplastico (termoplastico cristallino nei supporti per alte temperature, max. +270°)
- 3) Corpo girevole in lamiera inox AISI 304 stampata.
- 4) Sfere di acciaio inox AISI 420
- 5) Anello tenuta sfere in lamiera inox AISI 304 stampata.

MEDIUM DUTY TOP PLATE CASTORS INOX 20

- Finish: polished.
- 1) Top plate with forged central pin in pressed stainless steel-sheet AISI 304.
- 2) Thermoplastic dust protection ring (crystalline thermoplastic for high temperatures castors, max. 270°C).
- 3) Swivel fork in pressed stainless steel-sheet AISI 304.
- 4) Stainless steel balls AISI 420.
- 5) Balls retaining ring in pressed stainless steel sheet AISI 304.

MITTELLAST GEHÄUSE INOX 20 MIT EINBAUPLATTE

- Finish: poliert.
- 1) Einbauplatte aus gepresstem AISI 304 Edelstahlblech mit vorgeformtem Zapfen.
- 2) Staubring aus thermoplastischem Kunststoff (kristallin thermoplastischer Kunststoff für hohe Temperaturen, max. 270°C).
- 3) Lenkgabel aus gepresstem AISI 304 Edelstahlblech.
- 4) Kugeln aus AISI 420 Edelstahl.
- 5) Kugelkranzhalter aus gepresstem AISI 304 Edelstahlblech.

CHAPES MOYENNES INOX 20 A PLATINE

- Finition: polie.
- 1) Platine de fixation avec pivot central préformé en tôle inox AISI 304 emboutie.
- 2) Anneau pare-poudre en matière thermoplastique (thermoplastique cristalline dans les chapes pour hautes températures max. 270°C).
- 3) Fourche pivotante en tôle inox AISI 304 emboutie.
- 4) Billes en acier inox AISI 420.
- 5) Anneau porte-billes en tôle inox AISI 304 emboutie.

SOPORTES MEDIOS INOX 20 A PLATINA

- Acabado: pulido.
- 1) Platina de anclaje con perno central preformado en chapa inox AISI 304 estampada.
- 2) Anillo anti-polvo en material termoplastico (plastico cristallino en los soportes para altas temperaturas, max. 270°C).
- 3) Horquilla giratoria en chapa inox AISI 304 estampada.
- 4) Bolas en acero inox AISI 420.
- 5) Disco porta-bolas en chapa inox AISI 304 estampada.

⊘ D	80	100	100	125	125	125	150	150	175-180	200
⊓ U	40	40	50	40	50	50	50	50	60	60

STANDARD - STANDARD - STANDARD - STANDARD - STANDARD

Art.	02305	02310	02318	02315	02320	02325	02335	02330	02365	02370
Art.	02405	02410	02418	02415	02420	02425	02435	02430	02465	02470

ALTE TEMPERATURE - HIGH TEMPERATURES - HITZEBESTÄNDIG - HAUTES TEMPÉRATURES - ALTAS TEMPERATURAS

Art.	02805*	02810*	-	-	02820*	02825*	-	-	02865*	02870*
------	--------	--------	---	---	--------	--------	---	---	--------	--------

DATI TECNICI - TECHNICAL DATA - TECHNISCHE DATEN - DONNÉES TECHNIQUES - DATOS TECNICOS

H	106	128	129	154	160	160	161	161	216-218	240
AxB	102x83	102x83	102x83	102x83	102x83	135x110	102x83	135x110	135x110	135x110
axb	76x55 80x60	76x55 80x60	80x60	76x55 80x60	80x60	96x56 105x75 105x80	80x60	96x56 105x75 105x80	105x75 105x80	105x75 105x80
g	6	6	6	8	8	10	6	10	10	10
F	33	37	46	40	49	49	51	51	57	59
O	6	6	10	8	10	10	10	10	12	12
FR	FR	FR	FR	FR	FR	FR	FR	FR	FR	FR
Kg.	150	150	250	150	250	250	250	250	370	370

Per articoli con freno aggiungere FR al codice (vedere anche pag. 21) - To order items with brake add FR to part number (see also page 21) - Für gebremste Ausführungen FR zur Bestellnummer beifügen (siehe auch Seite 21) - Pour versions à frein ajouter FR à la référence produit (voir aussi page 21) - Para artículos con freno añadir FR al código (vean también la pág. 21).

* Non idoneo per impiego con freno - Not suitable for use with brake - Nicht geeignet für Feststeller - Pas indiqué pour l'application du frein - No apto para uso con freno.

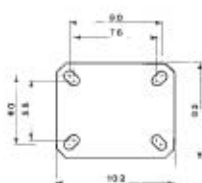

⊘ 80/40-125/40

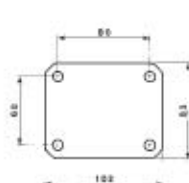

⊘ 100/50L-150/50L

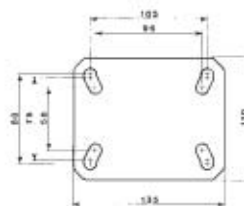

⊘ 125/50-150/50

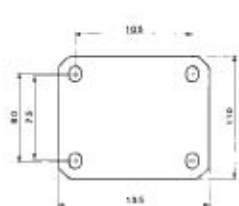

⊘ 175/60-200/60



SUPPORTI INOX 20 A FORO PASSANTE

1) Boccola di riduzione del foro passante in acciaio inox AISI 430. 2) Piastra porta sfere in lamiera inox AISI 304.

STAINLESS STEEL INOX 20 BOLT HOLE CASTORS

1) Bolt hole reduction bush in stainless steel AISI 430. 2) Stainless steel AISI 304 balls retaining plate.

ROSTFREIER GEHÄUSE INOX 20 MIT RÜCKENLOCH

1) Reduktionshülse zum Rückenloch aus Edelstahl AISI 430. 2) Kugelkranzhalter aus gepresstem Edelstahl AISI 304.

CHAPES INOX 20 A TROU CENTRAL

1) Bague de réduction du trou central en acier inox AISI 430. 2) Disque porte-billes en tôle inox AISI 304 estampée.

SOPORTES INOX 20 CON TALADRO LISO PASADOR

1) Casquillo de reducción por taladro en acero AISI 430. 2) Platina porta-bolas en chapa de acero inox AISI 304.

⊗	D	90	100	100	125	125	150	175-180	200
	U	40	40	50	40	50	50	60	60

STANDARD - STANDARD - STANDARD - STANDARD - STANDARD

🔪	Art.	02505HA	02510HA	02518HC	02515HA	02525HC	02530HC	02565HE	02570HE
	Art.	02505HB	02510HB	02518HD	02515HB	02525HD	02530HD	02565HF	02570HF

ALTE TEMPERATURE - HIGH TEMPERATURES - HITZBESTÄNDIG - HAUTES TEMPÉRATURES - ALTAS TEMPERATURAS

🔪	Art.	02905HA*	02910HA*	-	-	02925HC*	-	02965HE*	02970HE*
	Art.	02905HB*	02910HB*	-	-	02925HD*	-	02965HF*	02970HF*

DATI TECNICI - TECHNICAL DATA - TECHNISCHE DATEN - DONNÉES TECHNIQUES - DATOS TECNICOS

🔧	g	HA=10 / HB=12			HC=12 / HD=14		HE=12 / HF=16		
---	---	---------------	--	--	---------------	--	---------------	--	--

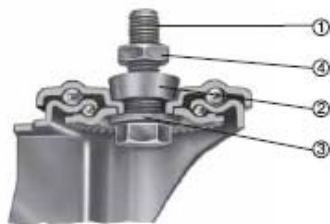

SUPPORTI INOX 20 A PERNO FILETTATO

1) Perno filettato in acciaio inox AISI 304. 2) Boccola di riduzione del foro in acciaio inox AISI 430. 3) Rondella inox AISI 304. 4) Dado inox AISI 304.

THREADED STEM STAINLESS STEEL INOX 20 CASTORS

1) Threaded stainless steel stem AISI 304. 2) Stainless steel AISI 430 bolt hole reduction bush. 3) Stainless steel washer AISI 304. 4) Stainless steel nut AISI 304.

ROSTFREIER GEHÄUSE INOX 20 MIT GEWINDESTIFT

1) Rostfreie Gewindestift aus Edelstahl AISI 304. 2) Reduktionshülse zum Rückenloch aus Edelstahl AISI 430. 3) Rostfreie Scheibe AISI 304. 4) Rostfreie Mutter AISI 304.

CHAPES INOX 20 A TIGE FILETÉE

1) Tige filetée en acier inox AISI 304. 2) Bague de réduction du trou central en acier inox AISI 430. 3) Rondelle inox AISI 304. 4) Ecrou inox AISI 304.

SOPORTES INOX 20 CON ESPIGA ROSCADA

1) Espiga roscada inox AISI 304. 2) Casquillo de reducción por el taladro en inox AISI 430. 3) Arandela inox AISI 304. 4) Tuerca inox AISI 304.

⊗	D	90	100	100	125	125	150	175-180	200
	U	40	40	50	40	50	50	60	60

STANDARD - STANDARD - STANDARD - STANDARD - STANDARD

🔪	Art.	02505YA	02510YA	02518YC	02515YA	02525YC	02530YC	02565YE	02570YE
	Art.	02505YB	02510YB	02518YD	02515YB	02525YD	02530YD	02565YF	02570YF

ALTE TEMPERATURE - HIGH TEMPERATURES - HITZBESTÄNDIG - HAUTES TEMPÉRATURES - ALTAS TEMPERATURAS

🔪	Art.	02905YA*	02910YA*	-	-	02925YC*	-	02965YE*	02970YE*
	Art.	02905YB*	02910YB*	-	-	02925YD*	-	02965YF*	02970YF*

DATI TECNICI - TECHNICAL DATA - TECHNISCHE DATEN - DONNÉES TECHNIQUES - DATOS TECNICOS

🔧	PxQ	YA=M10x25 / YB=M12x25			YC=M12x30 / YD=M14x30		YE=M12x30 / YF=M16x30		
---	-----	-----------------------	--	--	-----------------------	--	-----------------------	--	--

* Non idoneo per impiego con freno - Not suitable for use with brake - Nicht geeignet für Feststeller - Pas indiqué pour l'application du frein - No apto para uso con freno.

**P60 - M40 - M20
INOX 40 - INOX 20**

FR



FRENO ANTERIORE A PEDALE - Blocca contemporaneamente la rotazione della ruota e del supporto. È applicato ai supporti girevoli P60, M40 e M20 (molla in acciaio dacrometizzato) e Inox 40, Inox 20 (molla in acciaio inox AISI 301). Nei supporti P60, M40 e Inox 40 il freno è regolabile. Per articoli con freno aggiungere FR al codice.

TRAILING FOOT BRAKE - Locks wheel and swivel simultaneously. It is fitted to swivel castors P60, M40 and M20 (dacromet steel spring) and Inox 40, Inox 20 (AISI 301 stainless steel spring). The brake on castors P60, M40 and Inox 40 is adjustable. To order items with brake add FR to part number.

FUSS-FESTSTELLER IN NACHLAUF - Blockiert Räd und Lenkung gleichzeitig. Ausführung für Lenkgehäuse P60, M40 und M20 (Feder aus Stahl mit dacromet Schutz) und Inox 40, Inox 20 (Feder aus Edelstahl AISI 301). Die Ausführung für P60, M40 und Inox 40 Gehäuse ist nachstellbar. Für Rollen mit Totalfeststeller FR zur Bestell-Nr beifügen.

FREIN AVANT A PEDALE - Bloque en même temps la roue et le pivotement. Appliqué aux chapes pivotantes P60, M40 et M20 (ressort en acier dacromet) et Inox 40, Inox 20 (ressort en acier inox AISI 301). Le frein des chapes P60, M40 et Inox 40 est réglable. Pour articles avec frein ajouter FR au code.

FRENO ANTERIOR DE PIÉ - Bloquea simultaneamente el soporte y la rueda. Aplicado a los soportes giratorios P60, M40 y M20 (muelle en acero dacromet) y Inox 40, Inox 20 (muelle en acero inox AISI 301). En los soportes P60, M40 y Inox 40 el freno es ajustable. Para artículos con freno añadir FR al código.

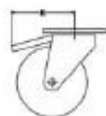

		R	R
M20 - Inox 20:	Ø 80/40-125/40	108 mm	Kg. 0,110
	Ø 100/50-160/50	140 mm	Kg. 0,180
	Ø 160/60-200/60	168 mm	Kg. 0,280
P60 - M40 - Inox 40:	Ø 100/50-160/50	140 mm	Kg. 0,270
	Ø 125/60-250/60	170 mm	Kg. 0,470

E70 - P60 - M40

FV



FRENO POSTERIORE A PEDALE - Blocca contemporaneamente la rotazione della ruota e del supporto. Leveraggio a snodo senza molle. È munito di vite di regolazione. Per articoli con freno aggiungere FV al codice.

LEADING FOOT BRAKE - Locks wheel and swivel simultaneously. Leverage without springs. Is adjustable by means of a screw. To order items with brake add FV to part number.

FUSS-FESTSTELLER IN VORLAUF - Blockiert Räd und Lenkung gleichzeitig. Hebefunktion ohne Feder. Mit Einstellschraube. Für Rollen mit Totalfeststeller FV zur Bestell-Nr beifügen.

FREIN ARRIER À PEDALE - Bloque en même temps la roue et le pivotement. Système de leviers sans ressort. Equipé d'une vis de réglage. Pour articles avec frein ajouter FV au code.

FRENO POSTERIOR DE PIÉ - Bloquea simultaneamente el soporte y la rueda. Sistema de levas sin muelle. Dotado de tornillo de regulación. Para artículos con freno añadir FV al código.



		R	R
E70:	Ø 150/60-200/60	150 mm	Kg. 0,500
P60 - M40:	Ø 125/60-250/60	150 mm	Kg. 0,500

E70 - P60 - M40 - M20

BLOCCAGGIO DIREZIONALE - Blocca la rotazione del supporto nella direzione del senso di marcia. Interasse fori: 80 mm.

DIRECTIONAL LOCK - Locks the swivel in the direction of motion. Bolt hole spacing: 80 mm.

RICHTUNGSFESTSTELLER - Lenksperr in Laufrichtung. Schraublochentfernung: 80 mm.

BLOCAGE DIRECTIONNEL - Bloque le pivotement dans la direction de marche. Entr'axe des trous de fixation: 80 mm.

BLOQUEO DIRECCIONAL - Bloquea el rodamiento del soporte en la dirección de marcha.

Distancia entre centros: 80 mm.



		Art. N.	R
M20:	Ø 125/50-160/50	P3935	Kg. 0,390
	Ø 160/60-200/60	P3960	Kg. 0,390
M40 - P60:	Ø 125/50-160/50	P3935	Kg. 0,390
	Ø 125/60-250/60	P3940	Kg. 0,390
E70:	Ø 150/60-200/60	P3945	Kg. 0,390

G80



BLOCCAGGIO DIREZIONALE A DUE POSIZIONI

Si aziona manualmente, blocca la rotazione del supporto in due punti a 180°. Aggiungere B2 al codice.

DIRECTIONAL LOCK

Manually operated, locks the swivelling of the castor in two points at 180°. Add B2 to partnumber.

RICHTUNGSFESTSTELLER

Hand betätigt, blockiert die Lenkung der Gehäuse auf zwei Punkte zu 180°. Beifügen B2 zur Bestellnummer.

BLOCAGE DIRECTIONNEL

Actionné manuellement, arrête le pivotement de la chape sur deux points à 180°. Ajouter B2 à la référence produit.

BLOQUEO DIRECCIONAL

Accionado manualmente, bloquea el girar de la horquilla en dos puntos a 180°. Añadir B2 al código.

G80:	Ø 125-150/105	Ø 300/153
	Ø 200/126	Ø 300/132+132
	Ø 250/153	Ø 400/132+132
	Ø 250/100+100	
E70:	Ø 300/153	

ORGANI DI ROTOLAMENTO - BEARINGS - LAGERUNG - ORGANS DE ROULEMENT - ORGANOS DE RODAMIENTO

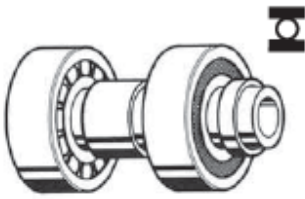

Cuscinetti a sfere schermati da un lato e bussola di riduzione in tubo di acciaio trafilato con distanziali in acciaio zincato: per usi continui ai massimi carichi.
 Shielded precision ball bearings, with reduction bush of drawn steel tube and spacers of zincplated steel: for continuous applications at highest loads.
 Präzisions-Rillenkugellager, einseitig abgeschirmt, mit Reduktionshülse aus gezogenem Stahl und Distanzröhren aus verzinktem Stahl: für Dauerbetrieb unter Höchstbelastung.
 Roulements à billes protégés sur un côté, entretoise de réduction en tube d'acier trafilé, et bague entretoisement en acier zincé: pour usage continu aux charges plus élevées.
 Cojinetes a bolas de precision protegidos por el lado exterior, casquillo de reducción en tubo de acero trellado y separadores internos y externos en acero cincado: para usos continuos a las máximas cargas.

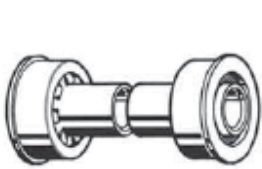

Cuscinetti a sfere schermati di costruzione speciale per le ruote BETA: per usi con frequente movimentazione ai massimi carichi consentiti delle ruote.
 Shielded ball bearings of special design for wheels series BETA: for frequent usage at maximum wheel loading.
 Abgeschirmte Rillenkugellager im Sonderkonstruktion für BETA Räder: für häufigen Lauf unter höchstmöglicher Belastung der Räder.
 Roulements à billes de construction speciale pour les roues BETA: pour usage fréquent aux charges plus élevées admis par les roues.
 Cojinetes a bolas de construcción especial para las ruedas BETA: para usos frecuentes a las máximas cargas permitidas para esta rueda.

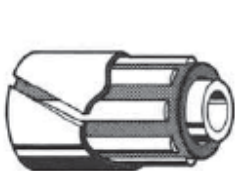

Cuscinetto a rullini temperati e rettificati, con pista di rotolamento in acciaio temperato e bussola in tubo di acciaio temperato: per usi continui ai massimi carichi.
 Hardened and rectified roller bearing, with hardened steel sleeve and bush of hardened steel tube: for continuous applications at highest loads.
 Rollenkorblager, gehärtet und geschliffen, mit gehärteter Lauffbuchse und gehärteter Reduktionshülse: für Dauerbetrieb unter Höchstbelastung.
 Roulement à rouleaux trempés et rectifiés, avec piste de roulement en acier trempé et entretoise en tube d'acier trempé: pour usage continu aux charges plus élevées.
 Cojinete a rodillos templados y rectificados con pista de rodadura en acero templado y casquillo de reducción en tubo de acero templado: para usos continuos a las máximas cargas.

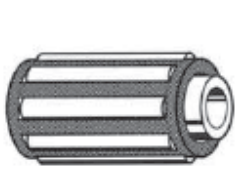

Cuscinetto a rullini standard e bussola in tubo di acciaio: per impiego in ambienti normali.
 Standard roller bearing and steel bush: for applications in normal environments.
 Rollenkorblager, standard, und Reduktionshülse aus Stahlrohr: für Betrieb unter normalen Bedingungen.
 Roulement à rouleaux standard et entretoise en tube acier: pour usage dans un milieu normal.
 Cojinete a rodillos standard y casquillo de reducción en tubo de acero: para usos en ambientes normales.

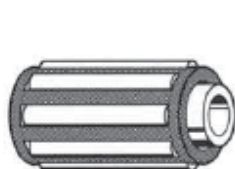

Cuscinetto a rullini Inox AISI 304 e bussola in acciaio inox AISI 304: per impiego in presenza di sostanze corrosive.
 Stainless steel roller bearing AISI 304 and stainless steel bush AISI 304: for applications in corrosive environments.
 Rollenkorblager, rostfrei, aus Edelstahl AISI 304 mit Reduktionshülse aus Edelstahl AISI 304: für Betrieb bei Korrosionsmitteln.
 Roulement à rouleaux Inox AISI 304 et entretoise en acier inox AISI 304: pour usage en presence de substances corrosives.
 Cojinete a rodillos Inox AISI 304 y casquillo de reducción en acero inox AISI 304: para usos en ambientes corrosivos.



Boccole in poliammide 6 autolubrificante e bussola di riduzione in tubo di acciaio o acciaio inox AISI 304: per usi intermittenti.
 Self-lubricating polyamide 6 bushes and steel or stainless steel AISI 304 reduction bush: for intermittent use.
 Buchsen aus Polyamid 6, selbstschmierend, und Reduktionshülse aus Stahl oder Edelstahl AISI 304: für zeitbegrenzten Betrieb.
 Bagues en Polyamide 6 autolubrificante et entretoise en acier ou acier inox AISI 304: pour usage intermittent.
 Buje en poliamida 6 autolubrificante y casquillo de reducción en tubo de acero o acero inox AISI 304: para usos intermitentes.

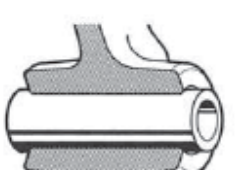

Foro passante e bussola di riduzione in tubo di acciaio o acciaio inox AISI 304: per usi intermittenti.
 Plain bore and reduction bush obtained from a steel tube or inox AISI 304: for intermittent use.
 Gleitlager und Reduktionshülse aus Stahl oder aus Edelstahl AISI 304: für zeitbegrenzten Betrieb.
 Alésage lisse et entretoise de réduction en tube acier ou acier inox AISI 304: pour usage intermittent.
 Agujero liso y casquillo de reducción en tubo de acero o acero inox AISI 304: para usos intermitentes.

				POLIURETANO & VULKOLLAN	POLYURETHANE & VULKOLLAN	POLYURETHAN & VULKOLLAN	POLYURÉTHANE & VULKOLLAN	POLIURETANO & VULKOLLAN
				POLIURETANO TERMOPLASTICO	THERMOPLASTIC POLYURETHANE	THERMOPLASTICHER POLYURETHAN	POLYURÉTHANE TERMOPLASTIQUE	POLIURETANO TERMOPLASTICO
				GOMMA	RUBBER	GUMMI	CAOUTCHOUC	GOMA
				POLIAMMIDE	POLYAMIDE	POLYAMID	POLYAMIDE	POLIAMIDA
				COMPATIBILITÀ CHIMICA	CHEMICAL COMPATIBILITY	CHEMISCHE BESTÄNDIGKEIT	COMPATIBILITÉ CHIMIQUE	COMPATIBILIDAD QUÍMICA
--	--	+	++	Acetato di etile	Ethyl acetate	Äthylacetat	Acétate d'ethyle	Acetato de etil
--	--	++	++	Acetone	Acetone	Aceton	Acétone	Acetona
--	-	++	--	Acido acetico	Acetic acid	Essigsäure	Acide acétique	Acido acético
--	--	+	--	Acido acetico glaciale	Acetic acid glacial	Eisessigsäure	Acide acétique glacial	Acido acético glacial
+	--	+	--	Acido cloridrico	Hydrochloric acid	Salzsäure	Acide chlorhydrique	Acido clorídrico
--	--	+	--	Acido cloridrico conc.	Hydrochloric acid conc.	Salzsäure Konz.	Acide chlorhydrique conc.	Acido clorídrico
--	/	--	-	Acido cromico	Chromic acid	Chromsäure	Acide chromique	Acido cromico
+	+	+	--	Acido formico	Formic acid	Ameisensäure	Acide formique	Acido fòrmico
/	-	++	--	Acido fosforico	Phosphoric acid	Phosphorsäure	Acide phosphorique	Acido fosfòrico
/	-	++	-	Acido lattico	Lactic acid	Milchsäure	Acide lactique	Acido lácteo
-	--	-	--	Acido nitrico	Nitric acid	Salpetersäure	Acide nitrique	Acido nítrico
-	--	-	--	Acido solforico	Sulphuric acid	Schwefelsäure	Acide sulfurique	Acido sulfúrico
++	++	++	++	Acqua	Water	Wasser	Eau	Agua
--	/	--	+	Acqua di cloro	Chlorine water	Chlorwasser	Eau chlorée	Agua clorada
++	-	+	--	Acqua ossigenata	Hydrogen peroxide	Wasserstoffsperoxyd	Eau oxygénée	Agua oxigenada
--	--	--	--	Acqua regia	Aqua regia	Königswasser	Eau régale	Agua regia
+	+	++	++	Alcol etilico	Ethyl alcohol	Äthylalkohol	Alcool ethylique	Alcohol etílico
-	--	++	++	Alcol metilico	Methyl alcohol	Methylalkohol	Alcool methylique	Alcohol metílico
--	/	++	++	Aldeide formica	Formaldehyde	Formaldehyd	Formaldéhyde	Aldehido fórmico
--	/	+	+	Anilina	Aniline	Anilin	Aniline	Anilina
+	--	--	++	Benzina	Gasoline	Benzin	Essence	Gasolina
--	/	--	--	Bromo	Bromine	Brom	Brome	Bromo
++	+	++	++	Carbonato di sodio	Sodium carbonate	Natriumcarbonat	Carbonate de sodium	Carbonato de sodio
--	--	--	--	Cloro	Chlorine	Chlor	Chlore	Cloro
--	--	--	+	Cloro benzene	Chlorobenzene	Chlorbenzol	Chlorebenzène	Clorobenceno
--	--	--	--	Cloroformio	Chloroform	Chloroform	Chloroforme	Cloroformo
--	--	--	+	Cloruro di metilene	Methylene dichloride	Methylenchlorid	Chlorure de méthylène	Cloruro de metileno
+	/	++	+	Cloruro di nichel	Nickel chloride	Nickelchlorid	Chlorure de nickel	Cloruro de níquel
+	/	+	++	Cloruro di sodio	Sodium chloride	Natriumchlorid	Chlorure de sodium	Cloruro de sodio
--	/	--	++	Cloruro di vinile	Vinyl chloride	Vinylchlorid	Chlorure de vinyle	Cloruro de vinilo
--	--	--	--	Cresolo	Cresols	Kresole	Crésol	Crisol
--	--	++	++	Dimetilformammide	Dimethylformamide	Dimethylformamid	Diméthylformamide	Dimetilformamida
+	+	--	++	Esano	Hexane	Hexan	Hexane	Hexano
/	+	/	++	Etere di petrolio	Petroleum ether	Erdöläther	Éther de pétrole	Eter de petróleo
+	++	+	--	Glicole etilenico	Ethylene glycol	Äthylenglykol	Glycol éthylique	Etillenglicol
--	/	++	+	Iodossido di potassio	Potassium hydroxide	Kaliumhydroxyd	Hydroxyde de potassium	Hidròxido de potasio
+	--	+	++	Iodossido di sodio	Sodium hydroxide	Natriumhydroxyd	Hydroxide de sodium	Hidròxido de sodio
--	-	++	++	Ipclorito di sodio	Sodium hypochlorite	Natriumhypochlorit	Hypochlorite de sodium	Ipclorito de sodio
++	++	++	++	Latte	Milk	Milch	Lait	Leche
--	--	--	++	Metiletichetone	Methylethylketone	Methyläthylketon	Méthyle éthyle cétone	Metil-etilcetona
+	+	++	++	Nitrato di sodio	Sodium nitrate	Natriumnitrat	Nitrate de sodium	Nitrato de sodio
++	++	--	++	Oli minerali	Mineral oils	Mineralöle	Huiles minéral	Acéite mineral
++	/	--	++	Oli vegetali	Vegetable oils	Pflanzlicheöle	Huiles végétales	Acéite vegetal
++	--	--	++	Olio di paraffina	Paraffin oil	Paraffinöl	Huile de paraffine	Acéite de paraffina
+	+	--	++	Olio diesel (nafta)	Diesel oil	Dieseöl	Huile diesel	Acéite diesel
++	/	--	--	Ozono	Ozone	Ozon	Ozone	Ozono
+	/	--	++	Petrolio	Petrol	Erdöl	Pétrole	Petròleo
++	/	+	++	Solfato di rame	Copper sulphate	Kupfersulfat	Sulfate de cuivre	Sulfato de cobre
--	--	--	++	Trementina	Terpentine	Terpentin	Térébenthine	Trementina
--	--	--	+	Tricloroetilene (trielina)	Trichloroethylene	Trichloräthylen	Trichloréthylène	Tricloroetileno
+	+	+	+	Vapore	Steam	Dampf	Vapeur	Vapour

++	Resistente	Resistant	Beständig	Résistant	Resistente
+	Discretamente resistente	Fairly resistant	Fair beständig	Moyennement résistant	Discretamente resistente
+	Probabilmente resistente	Probably resistant	Wahrscheinlich beständig	Probablement résistant	Probablemente resistente
-	Discretamente attaccato	Fairly attacked	Wahrscheinlich angegriffen	Moyennement attaqué	Discretamente apegato
--	Non resistente	Not resistant	Nicht beständig	Non-résistant	No resistente
/	Nessun dato	No data available	Keine Information	Pas de données	No datos