

Ceramic Singlelayer DC Disc Capacitors for General Purpose Class 1, Class 2, and Class 3, 1 kV_{DC}, 2 kV_{DC}, 3 kV_{DC}, 6 kV_{DC}

FEATURES

- High capacitance with small size
- High stability
- Crimp and straight lead styles
- Material categorization: for definitions of compliance please see www.vishay.com/doc?99912

RoHS
COMPLIANT

APPLICATIONS

- Temperature compensation
- Coupling and decoupling
- Bypassing

QUICK REFERENCE DATA							
DESCRIPTION	VALUE						
Ceramic Class	1		2			3	
Ceramic Dielectric	SL0	S3N	X7R	Y5P	X5F	Z5U	Y5V
Voltage (V _{DC})	1000, 2000, 3000, 6000	6000	1000, 2000, 3000	1000, 2000, 3000	1000, 2000	1000, 2000, 3000, 6000	1000, 2000, 3000
Min. Capacitance (pF)	10	47	100	100	100	1000	1000
Max. Capacitance (pF)	470	150	4700	10 000	4700	22 000	33 000
Mounting	Radial						

MARKING

Marking indicates capacitance value and tolerance in accordance with "EIA 198" and voltage marks.

OPERATING TEMPERATURE RANGE

SL0, X7R, X5F: -55 °C to +125 °C

Y5P, Z5U, Z5V, Y5V: -30 °C to +125 °C

TEMPERATURE CHARACTERISTICS

Class 1: SL0, S3N

Class 2: X7R, Y5P, X5F, Z5U

Class 3: Y5V

SECTIONAL SPECIFICATIONS

Climatic category (according to EN 60058-1)

Class 1 and 2: 55/125/21

Class 3: 30/85/21

APPROVALS

EIA 198

IEC 60384-8

IEC 60384-9

DESIGN

The capacitors consist of a ceramic disc both sides of which are silver-plated. Connection leads are made of tinned copper wire, having diameters of 0.6 mm or 0.8 mm.

The capacitors may be supplied with straight or kinked leads having a lead spacing of 5.0 mm, 7.5 mm and 10.0 mm.

Coating is made of epoxy resin in accordance with UL 94 V-0.

CAPACITANCE RANGE

10 pF to 33 nF

TOLERANCE ON CAPACITANCE

± 5 %; ± 10 %; ± 20 %; + 80 % / - 20 %

RATED VOLTAGE

1000 V_{DC}, 2000 V_{DC}, 3000 V_{DC}, 6000 V_{DC}

TEST VOLTAGE

200 % of rated voltage

INSULATION RESISTANCE AT RATED VOLTAGE

10 GΩ min.

DISSIPATION FACTOR

Class 1: 0.1 max. when C ≥ 30 pF
(1 MHz, 1 V where C ≤ 1000 pF, and 1 kHz, 1 V where C > 1000 pF)
For C < 30 pF: DF = 100/(400 + 20 °C)
DF = dissipation factor in %;
C = capacitance value in pF

Class 2: 2.5 % max. (1 kHz, 1 V)

Class 3: 5 % max. (1 kHz, 1 V)

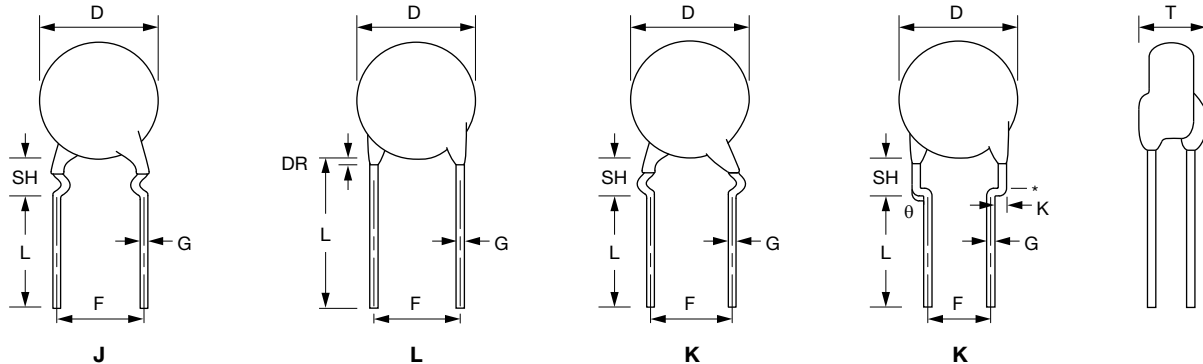
LEAD CONFIGURATION (in millimeters)

Note

- Lead-spacing 2.5 mm is available for L lead configuration only.

MARKING

Size 25

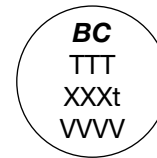
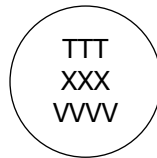
Size 29 and above

Note

- Refer to specified part for detail marking.

ORDERING CODE INFORMATION

S	102	K	29	Y5P	N	6	3	J	5	R
1	2 3 4	5	6 7	8 9 10	11	12	13	14	15	16
Product Type	Capacitance (pF)	Capacitance Tolerance	Size Code	T.C. Code	Rated Voltage	Lead Diameter	Packaging / Lead Length	Lead Style	Lead Spacing	RoHS-Compliant
S series	The first two digits are the significant figures of capacitance and the last digit is a multiplier as follows: 0 = * 1 1 = * 10 2 = * 100 3 = * 1000	J = ± 5 % K = ± 10 % M = ± 20 % Z = + 80 % / - 20 %	Please refer to relevant datasheet	Please refer to relevant datasheet	N = 1000 V _{DC} P = 2000 V _{DC} R = 3000 V _{DC} U = 6000 V _{DC}	6 = 0.60 mm ± 0.05 mm 8 = 0.80 mm ± 0.05 mm	3 = bulk T = tape and reel U = ammo	Please refer to relevant datasheet	5 = 5.0 mm 6 = 6.4 mm 7 = 7.5 mm 0 = 10.0 mm	R = RoHS-compliant G = RoHS-compliant and halogen-free



ORDERING CODES

DIELECTRIC SLO (1000 V _{DC} / 2000 V _{DC})						
CAP. (pF)	1000 V _{DC}			2000 V _{DC}		
	ORDERING CODE	DIAMETER (mm max.)	THICKNESS (mm max.)	ORDERING CODE	DIAMETER (mm max.)	THICKNESS (mm max.)
10	S100#25SLO6###R	6.5	4	S100#25SLOP6###R	6.5	4.5
12	S120#25SLO6###R	6.5	4	S120#25SLOP6###R	6.5	4.5
15	S150#25SLO6###R	6.5	4	S150#25SLOP6###R	6.5	4.5
18	S180#25SLO6###R	6.5	4	S180#25SLOP6###R	6.5	4.5
22	S220#25SLO6###R	6.5	4	S220#25SLOP6###R	6.5	4.5
27	S270#25SLO6###R	6.5	4	S270#25SLOP6###R	6.5	4.5
33	S330#25SLO6###R	6.5	4	S330#29SLOP6###R	7.5	4.5
39	S390#25SLO6###R	6.5	4	S390#29SLOP6###R	7.5	4.5
47	S470#25SLO6###R	6.5	4	S470#29SLOP6###R	7.5	4.5
56	S560#29SLO6###R	7.5	4	S560#29SLOP6###R	7.5	4.5
68	S680#29SLO6###R	7.5	4	S680#33SLOP6###R	8.5	4.5
82	S820#29SLO6###R	7.5	4	S820#33SLOP6###R	8.5	4.5
100	S101#29SLO6###R	7.5	4	S101#39SLOP6###R	10	4.5
120	S121#33SLO6###R	8.5	4	S121#39SLOP6###R	10	4.5
150	S151#33SLO6###R	8.5	4	S151#43SLOP6###R	11	4.5
180	S181#39SLO6###R	10	4	/	/	/
220	S221#39SLO6###R	10	4	/	/	/

DIELECTRIC SLO (3000 V _{DC} / 6000 V _{DC})						
CAP. (pF)	3000 V _{DC}			6000 V _{DC} ⁽¹⁾		
	ORDERING CODE	DIAMETER (mm max.)	THICKNESS (mm max.)	ORDERING CODE	DIAMETER (mm max.)	THICKNESS (mm max.)
10	S100#33SLO6###R	8.5	5.5	S100#39SLOU83LOR	10	8
12	S120#33SLO6###R	8.5	5.5	S120#39SLOU83LOR	10	8
15	S150#33SLO6###R	8.5	5.5	S150#43SLOU83LOR	11	8
18	S180#33SLO6###R	8.5	5.5	S180#43SLOU83LOR	11	8
22	S220#33SLO6###R	8.5	5.5	S220#43SLOU83LOR	11	8
27	S270#33SLO6###R	8.5	5.5	S270#47SLOU83LOR	12	8
33	S330#33SLO6###R	8.5	5.5	S330#53SLOU83LOR	13.5	8
39	S390#33SLO6###R	8.5	5.5	/	/	/
47	S470#33SLO6###R	8.5	5.5	/	/	/
56	S560#39SLO6###R	10	5.5	/	/	/
68	S680#39SLO6###R	10	5.5	/	/	/

Notes

- Lead diameter is 0.6 mm
 - # 5th digit is capacitance tolerance code: ± 5 % = J; ± 10 % = K
 - # 13th digit is packaging code: bulk = 3; reel = T; ammo = U
 - # 14th digit is lead style code: L; J; K (J is valid for 1 kV only)
 - # 15th digit is lead spacing code: 5.0 mm = 5; 6.4 mm = 6; 7.5 mm = 7; 10.0 mm = 0
- (1) For 6000 V part, only straight lead configuration (0.8 mm lead diameter) and bulk packaging are available



DIELECTRIC Z5U (1000 V_{DC} / 2000 V_{DC})						
CAP. (pF)	1000 V _{DC}			2000 V _{DC}		
	ORDERING CODE	DIAMETER (mm max.)	THICKNESS (mm max.)	ORDERING CODE	DIAMETER (mm max.)	THICKNESS (mm max.)
1000	S102#25Z5UN6###R	6.5	4	S102#29Z5UP6###R	7.5	4.5
1500	S152#29Z5UN6###R	7.5	4	S152#29Z5UP6###R	7.5	4.5
2200	S222#29Z5UN6###R	7.5	4	S222#33Z5UP6###R	8.5	4.5
3300	S332#33Z5UN6###R	8.5	4	S332#43Z5UP6###R	11.0	4.5
4700	S472#39Z5UN6###R	10	4	S472#47Z5UP6###R	12.0	4.5
6800	S682#43Z5UN6###R	11	4	S682#53Z5UP63K7R	13.5	4.5
10 000	S103#47Z5UN6###R	12	4	S103#69Z5UP63K7R	17.5	4.5
15 000	S153#59Z5UN63J7R	15	4	/	/	/
22 000	S223#75Z5UN83J0R	19	4	/	/	/

DIELECTRIC Z5U (3000 V_{DC} / 6000 V_{DC})						
CAP. (pF)	3000 V _{DC}			6000 V _{DC}		
	ORDERING CODE	DIAMETER (mm max.)	THICKNESS (mm max.)	ORDERING CODE	DIAMETER (mm max.)	THICKNESS (mm max.)
220	/	/	/	S221#39Z5UU83L0R	10	8
330	/	/	/	S331#43Z5UU83L0R	11	8
470	S471#33Z5UR6###R	8.5	5.5	S471#47Z5UU83L0R	12	8
1000	S102#33Z5UR6###R	8.5	5.5	S102#59Z5UU83L0R	15	8
1500	S152#39Z5UR6###R	10.0	5.5	S152#69Z5UU83L0R	17.5	8
2200	S222#43Z5UR6###R	11.0	5.5	S222M75Z5UU83L0R	19	8
3300	S332#53Z5UR63K7R	13.5	5.5	/	/	/
4700	S472#69Z5UR63K7R	17.5	5.5	/	/	/

Notes

- Lead diameter is 0.6 mm
- # 5th digit is capacitance tolerance code: ± 20 % = M; + 80 % / - 20 % = Z
- # 13th digit is packaging code: bulk = 3; reel = T; ammo = U
- # 14th digit is lead style code: L; J; K (J is valid for 1 kV only)
- # 15th digit is lead spacing code: 5.0 mm = 5; 6.4 mm = 6; 7.5 mm = 7; 10.0 mm = 0



DIELECTRIC Y5P (1000 V _{DC} / 2000 V _{DC})						
CAP. (pF)	1000 V _{DC}			2000 V _{DC}		
	ORDERING CODE	DIAMETER (mm max.)	THICKNESS (mm max.)	ORDERING CODE	DIAMETER (mm max.)	THICKNESS (mm max.)
100	S101#25Y5PN6###R	6.5	4.0	S101#25Y5PP6###R	6.5	4.5
120	S121#25Y5PN6###R	6.5	4.0	S121#25Y5PP6###R	6.5	4.5
150	S151#25Y5PN6###R	6.5	4.0	S151#25Y5PP6###R	6.5	4.5
180	S181#25Y5PN6###R	6.5	4.0	S181#25Y5PP6###R	6.5	4.5
220	S221#25Y5PN6###R	6.5	4.0	S221#25Y5PP6###R	6.5	4.5
270	S271#25Y5PN6###R	6.5	4.0	S271#25Y5PP6###R	6.5	4.5
330	S331#25Y5PN6###R	6.5	4.0	S331#25Y5PP6###R	6.5	4.5
470	S471#25Y5PN6###R	6.5	4.0	S471#29Y5PP6###R	7.5	4.5
560	S561#29Y5PN6###R	7.5	4.0	S561#29Y5PP6###R	7.5	4.5
680	S681#29Y5PN6###R	7.5	4.0	S681#29Y5PP6###R	7.5	4.5
820	S821#29Y5PN7###R	7.5	4.0	S821#33Y5PP6###R	8.5	4.5
1000	S102#29Y5PN6###R	7.5	4.0	S102#33Y5PP6###R	8.5	4.5
1500	S152#33Y5PN6###R	8.5	4.0	S152#39Y5PP6###R	10.0	4.5
1800	S182#33Y5PN6###R	8.5	4.0	S182#43Y5PP6###R	11.0	4.5
2200	S222#39Y5PN6###R	10.0	4.0	S222#43Y5PP6###R	11.0	4.5
3300	S332#43Y5PN6###R	11.0	4.0	S332#53Y5PP6###R	13.5	4.5
4700	S472#53Y5PN6###R	13.5	4.0	S472#69Y5PP63K7R	17.5	4.5
6800	S682#59Y5PN63J7R	15.0	4.0	/	/	/
10 000	S103#75Y5PN83J0R	19.0	4.0	/	/	/

DIELECTRIC Y5P (3000 V _{DC})			
CAP. (pF)	3000 V _{DC}		
	ORDERING CODE	DIAMETER (mm max.)	THICKNESS (mm max.)
100	S101#33Y5PR6###R	8.5	5.5
120	S121#33Y5PR6###R	8.5	5.5
150	S151#33Y5PR6###R	8.5	5.5
180	S181#33Y5PR6###R	8.5	5.5
220	S221#33Y5PR6###R	8.5	5.5
270	S271#33Y5PR6###R	8.5	5.5
330	S331#33Y5PR6###R	8.5	5.5
470	S471#33Y5PR6###R	8.5	5.5
560	S561#39Y5PR6###R	10.0	5.5
680	S681#39Y5PR6###R	10.0	5.5
820	S821#39Y5PR6###R	10.0	5.5
1000	S102#43Y5PR6###R	11.0	5.5
1500	S152#47Y5PR6###R	12.0	5.5
1800	S182#47Y5PR6###R	12.0	5.5
2200	S222#59Y5PR63K7R	15.0	5.5
3300	S332#75Y5PR83K0R	19.0	5.5

Notes

- Lead diameter is 0.6 mm
- # 5th digit is capacitance tolerance code: ± 5 % = J; ± 10 % = K
- # 13th digit is packaging code: bulk = 3; reel = T; ammo = U
- # 14th digit is lead style code: L; J; K (J is valid for 1 kV only)
- # 15th digit is lead spacing code: 5.0 mm = 5; 6.4 mm = 6; 7.5 mm = 7; 10.0 mm = 0



DIELECTRIC X7R (1000 V _{DC} / 2000 V _{DC})						
CAP. (pF)	1000 V _{DC}			2000 V _{DC}		
	ORDERING CODE	DIAMETER (mm max.)	THICKNESS (mm max.)	ORDERING CODE	DIAMETER (mm max.)	THICKNESS (mm max.)
100	S101#25X7RN6###R	6.5	4.0	S101#25X7RP6###R	6.5	4.5
120	S121#25X7RN6###R	6.5	4.0	S121#25X7RP6###R	6.5	4.5
150	S151#25X7RN6###R	6.5	4.0	S151#25X7RP6###R	6.5	4.5
180	S181#25X7RN6###R	6.5	4.0	S181#25X7RP6###R	6.5	4.5
220	S221#25X7RN6###R	6.5	4.0	S221#25X7RP6###R	6.5	4.5
270	S271#25X7RN6###R	6.5	4.0	S271#25X7RP6###R	6.5	4.5
330	S331#25X7RN6###R	6.5	4.0	S331#25X7RP6###R	6.5	4.5
470	S471#29X7RN6###R	7.5	4.0	S471#29X7RP6###R	7.5	4.5
560	S561#29X7RN6###R	7.5	4.0	S561#33X7RP6###R	8.5	4.5
680	S681#29X7RN6###R	7.5	4.0	S681#33X7RP6###R	8.5	4.5
820	S821#29X7RN7###R	7.5	4.0	S821#39X7RP6###R	10.0	4.5
1000	S102#33X7RN6###R	8.5	4.0	S102#39X7RP6###R	10.0	4.5
1500	S152#39X7RN6###R	10.0	4.0	S152#43X7RP6###R	11.0	4.5
1800	S182#43X7RN6###R	11.0	4.0	S182#47X7RP6###R	12.0	4.5
2200	S222#43X7RN6###R	11.0	4.0	S222#53X7RP6###R	13.0	4.5
3300	S332#47X7RN6###R	12.0	4.0	S332#59X7RP63K7R	15.0	4.5
4700	S472#59X7RN63J7R	15.0	4.0	/	/	/

DIELECTRIC X7R (3000 V _{DC})			
CAP. (pF)	3000 V _{DC}		
	ORDERING CODE	DIAMETER (mm max.)	THICKNESS (mm max.)
100	S101#33X7RR6###R	8.5	5.5
120	S121#33X7RR6###R	8.5	5.5
150	S151#33X7RR6###R	8.5	5.5
180	S181#33X7RR6###R	8.5	5.5
220	S221#33X7RR6###R	8.5	5.5
270	S271#33X7RR6###R	8.5	5.5
330	S331#33X7RR6###R	8.5	5.5
470	S471#33X7RR6###R	8.5	5.5
560	S561#39X7RR6###R	10.0	5.5
680	S681#39X7RR6###R	10.0	5.5
820	S821#43X7RR6###R	11.0	5.5
1000	S102#43X7RR6###R	11.0	5.5
1500	S152#53X7RR6###R	13.0	5.5
1800	S182#59X7RR63K7R	15.0	5.5
2200	S222#59X7RR63K7R	15.0	5.5

Notes

- Lead diameter is 0.6 mm
- # 5th digit is capacitance tolerance code: ± 5 % = J; ± 10 % = K
- # 13th digit is packaging code: bulk = 3; reel = T; ammo = U
- # 14th digit is lead style code: L; J; K (J is valid for 1 kV only)
- # 15th digit is lead spacing code: 5.0 mm = 5; 6.4 mm = 6; 7.5 mm = 7; 10.0 mm = 0



DIELECTRIC Y5V (1000 V _{DC} / 2000 V _{DC})						
CAP. (pF)	1000 V _{DC}			2000 V _{DC}		
	ORDERING CODE	DIAMETER (mm max.)	THICKNESS (mm max.)	ORDERING CODE	DIAMETER (mm max.)	THICKNESS (mm max.)
1000	S102Z25Y5VN6###R	6.5	4.0	S102Z29Y5VP6###R	7.5	4.5
1500	S152Z25Y5VN6###R	6.5	4.0	S152Z29Y5VP6###R	7.5	4.5
2200	S222Z29Y5VN6###R	7.5	4.0	S222Z33Y5VP6###R	8.5	4.5
3300	S332Z29Y5VN6###R	7.5	4.0	S332Z39Y5VP6###R	10.0	4.5
4700	S472Z33Y5VN6###R	8.5	4.0	S472Z43Y5VP6###R	11.0	4.5
6800	S682Z39Y5VN6###R	10.0	4.0	S682Z47Y5VP6###R	12.0	4.5
10 000	S103Z43Y5VN6###R	11.0	4.0	S103Z59Y5VP6###R	15.0	4.5
15 000	S153Z53Y5VN63J7R	13.5	4.0	/	/	/
22 000	S223Z59Y5VN63J7R	15.0	4.0	/	/	/
33 000	S333Z75Y5VN83J0R	19.0	4.0	/	/	/

DIELECTRIC Y5V (3000 V _{DC})			
CAP. (pF)	3000 V _{DC}		
	ORDERING CODE	DIAMETER (mm max.)	THICKNESS (mm max.)
1000	S102Z33Y5VR6###R	8.5	5.5
1500	S152Z33Y5VR6###R	8.5	5.5
2200	S222Z39Y5VR6###R	10.0	5.5
3300	S332Z43Y5VR6###R	11.0	5.5
4700	S472Z47Y5VR6###R	12.0	5.5
6800	S682Z59Y5VR6###R	15.0	5.5

Notes

- Lead diameter is 0.6 mm
- # 5th digit is capacitance tolerance code: ± 5 % = J; ± 10 % = K
- # 13th digit is packaging code: bulk = 3; reel = T; ammo = U
- # 14th digit is lead style code: L; J; K (J is valid for 1 kV only)
- # 15th digit is lead spacing code: 5.0 mm = 5; 6.4 mm = 6; 7.5 mm = 7; 10.0 mm = 0

DIELECTRIC X5F (1000 V_{DC} / 2000 V_{DC})						
CAP. (pF)	1000 V _{DC}			2000 V _{DC}		
	ORDERING CODE	DIAMETER (mm max.)	THICKNESS (mm max.)	ORDERING CODE	DIAMETER (mm max.)	THICKNESS (mm max.)
100	S101#25X5FN6###R	6.5	4.0	S101#25X5FP6###R	6.5	4.5
120	S121#25X5FN6###R	6.5	4.0	S121#25X5FP6###R	6.5	4.5
150	S151#25X5FN6###R	6.5	4.0	S151#25X5FP6###R	6.5	4.5
180	S181#25X5FN6###R	6.5	4.0	S181#25X5FP6###R	6.5	4.5
220	S221#25X5FN6###R	6.5	4.0	S221#25X5FP6###R	6.5	4.5
270	S271#25X5FN6###R	6.5	4.0	S271#29X5FP6###R	7.5	4.5
330	S331#25X5FN6###R	6.5	4.0	S331#29X5FP6###R	7.5	4.5
390	S391#25X5FN6###R	6.5	4.0	S391#31X5FP6###R	8.0	4.5
470	S471#25X5FN6###R	6.5	4.0	S471#31X5FP6###R	8.0	4.5
560	S561#29X5FN6###R	7.5	4.0	S561#33X5FP6###R	8.5	4.5
680	S681#29X5FN6###R	7.5	4.0	S681#39X5FP6###R	10.0	4.5
820	S821#29X5FN7###R	7.5	4.0	S821#43X5FP6###R	11.0	4.5
1000	S102#29X5FN6###R	7.5	4.0	S102#43X5FP6###R	11.0	4.5
1500	S152#39X5FN6###R	10.0	4.0	S152#47X5FP6###R	12.0	4.5
1800	S182#43X5FN6###R	11.0	4.0	S182#53X5FP63K7R	13.5	4.5
2200	S222#43X5FN6###R	11.0	4.0	S222#59X5FP63K7R	15.0	4.5
3300	S332#53X5FN63J7R	12.0	4.0	S332#65X5FP63K7R	16.5	4.5
4700	S472#63X5FN63J7R	15.0	4.0	/	/	/

Notes

- Lead diameter is 0.6 mm
- # 5th digit is capacitance tolerance code: ± 5 % = J; ± 10 % = K
- # 13th digit is packaging code: bulk = 3; reel = T; ammo = U
- # 14th digit is lead style code: L; J; K (J is valid for 1 kV only)
- # 15th digit is lead spacing code: 5.0 mm = 5; 6.4 mm = 6; 7.5 mm = 7; 10.0 mm = 0

DIELECTRIC S3N (6000 V_{DC})			
CAP. (pF)	6000 V _{DC}		
	ORDERING CODE	DIAMETER (mm max.)	THICKNESS (mm max.)
47	S470M43S3NU83L0R	11.0	8.0
68	S680M53S3NU83L0R	13.5	8.0
100	S101M59S3NU83L0R	15.0	8.0
150	S151M59S3NU83L0R	15.0	8.0

Notes

- Lead diameter is 0.6 mm
- # 5th digit is capacitance tolerance code: ± 5 % = J; ± 10 % = K
- # 13th digit is packaging code: bulk = 3; reel = T; ammo = U
- # 14th digit is lead style code: L; J; K (J is valid for 1 kV only)
- # 15th digit is lead spacing code: 5.0 mm = 5; 6.4 mm = 6; 7.5 mm = 7; 10.0 mm = 0

TAPING AND PACKAGING
LABELLING

Each reel is provided with a label showing the following details:

manufacturer, D style, capacitance, tolerance, batch number, quantity of components, rated voltage, dielectric.

On special request other designations can be shown.

For example:

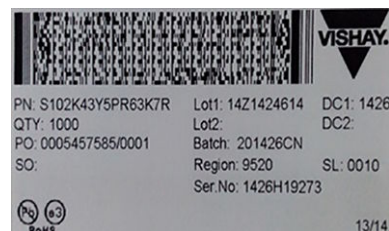

PACKAGING QUANTITIES AND BOX DIMENSIONS					
PACKAGING	SIZE CODE	LEAD SPACING (mm)	RATED VOLTAGE	SMALLEST PACKAGING QUANTITY (SPQ)	BOX DIMENSIONS L x W x H (mm)
Tape on reel	≤ 47	≤ 6.4	≤ 2000	2000	370 x 370 x 60
		≥ 7.5	all	1000	
	≥ 59	all	all	500	
Ammopack	≤ 47	≤ 6.4	< 2000	2000	335 x 240 x 50
		≥ 7.5	≥ 2000	1500	335 x 290 x 50
	> 47	> 6.4	all	1000	
Bulk ⁽¹⁾	< 49	all	< 6000	1000	245 x 120 x 65
	49 to 75	all	< 6000	500	
	> 75	all	< 6000	250	
	≤ 49	all	6000	500	
	> 49	all	6000	250	

Note

⁽¹⁾ SPQ contains one or a multiple of poly-bags, 1000 units per bag.

CAPACITORS ON TAPE				
PARAMETER	SYMBOL	DIMENSIONS (mm)		
Body diameter	D	11.0 max.	11.0 max.	14.0 max.
Lead diameter	d	0.6 ± 0.05	0.6 ± 0.05	0.6 ± 0.05
Pitch of component	p	12.7 ± 1.0	12.7 ± 1.0	15.0 ± 1.0
Pitch of sprocket hole	P ₀	12.7 ± 0.3	12.7 ± 0.3	15.0 ± 0.3
Distance, hole center to lead	P ₁	5.1 ± 0.7	3.85 ± 0.7	3.75 ± 0.7
Distance, hole to center of component	P ₂	6.35 ± 1.3	6.35 ± 1.3	7.5 ± 1.5
Lead spacing	F	2.5 + 0.60 / - 0.40	5.0 + 0.60 / - 0.40	7.5 + 0.6 / - 0.4
Average deviation across tape	Δh	± 1.0 max.	± 1.0 max.	± 1.0 max.
Average deviation in direction of reeling	ΔP	± 1.0 max.	± 1.0 max.	± 1.0 max.
Carrier tape width	W	18.0 + 1.0 / - 0.5	18.0 + 1.0 / - 0.5	18.0 + 1.0 / - 0.5
Hold-down tape width	W ₀	5.0 min.	5.0 min.	5.0 min.
Position of sprocket hole	W ₁	9.0 + 0.75 / - 0.5	9.0 + 0.75 / - 0.5	9.0 + 0.75 / - 0.5
Distance of hold-down tape	W ₂	3.0 max.	3.0 max.	3.0 max.
Maximum component height	H ₁	32 max.	32 max.	40 max.
Height to seating plane (for kinked leads)	H ₀	16.0 ± 0.5	16.0 ± 0.5	16.0 ± 0.5
Height to seating plane (for straight leads)	H ₀	20.0 ± 0.5	20.0 ± 0.5	20.0 ± 0.5
Length of cut leads	L	11.0 max.	11.0 max.	11.0 max.
Length of lead protrusion	e	1.0 max.	1.0 max.	1.0 max.
Diameter of sprocket hole	D ₀	4.0 ± 0.2	4.0 ± 0.2	4.0 ± 0.2
Total tape thickness	t	0.9 max.	0.9 max.	0.9 max.
Maximum thickness of taping and wires	t ₁	1.5 max.	1.5 max.	1.5 max.

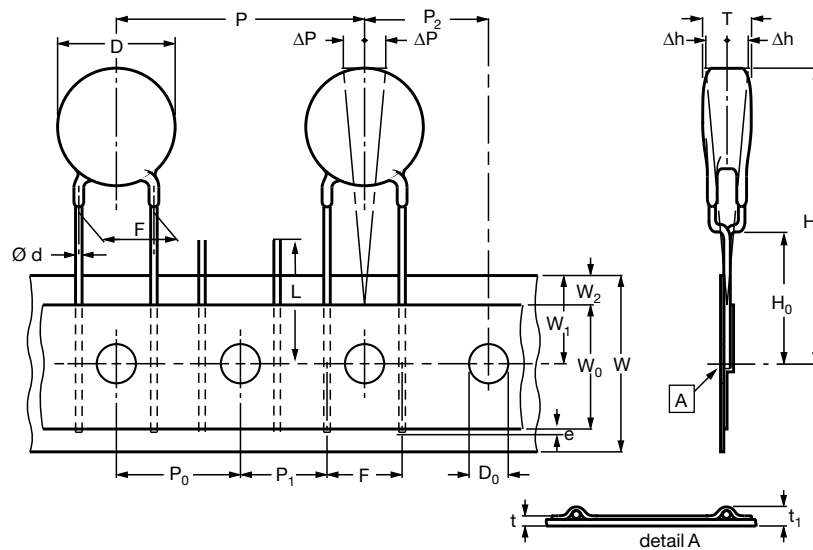

DIMENSIONS OF TAPE		
SYMBOL	PARAMETER	DIMENSIONS (mm)
D ⁽¹⁾	Body diameter	19.0 max.
d	Lead diameter	0.6 ± 0.05
P	Pitch of component	25.4 ± 1
P ₀ ⁽²⁾	Pitch of sprocket hole	12.7 ± 0.3
P ₁ ⁽³⁾	Distance, hole center to lead	7.7 or 6.4 ± 1.0
P ₂ ⁽³⁾	Distance, hole to center of component	12.7 ± 1.5
F	Lead spacing	10.0 or 12.5 + 0.6 / - 0.4
Δh	Average deviation across tape	± 1.0 max.
ΔP	Average deviation in direction of reeling	± 1.0 max.
W	Carrier tape width	18.0 + 1 / - 0.5
W ₀	Hold-down tape width	5.0 min.
W ₁	Position of sprocket hole	9.0 + 0.75 / - 0.5
W ₂	Distance of hold-down tape	3.0 max.
H ₁	Maximum component height	40.0
H ₀	Height to seating plane (for kinked leads)	16.0 ± 0.5
H ₀	Height to seating plane (for straight leads)	20.0 ± 0.5
L	Length of cut leads	11.0 max.
l	Length of lead protrusion	1.0 max.
D ₀	Diameter of sprocket hole	4.0 ± 0.2
t	Total tape thickness	0.9 max.

Notes

- (1) See Ordering Information table
 (2) Cumulative pitch error: ± 1 mm / 20 pitches
 (3) Obliquity maximum 3°



Disclaimer

ALL PRODUCT, PRODUCT SPECIFICATIONS AND DATA ARE SUBJECT TO CHANGE WITHOUT NOTICE TO IMPROVE RELIABILITY, FUNCTION OR DESIGN OR OTHERWISE.

Vishay Intertechnology, Inc., its affiliates, agents, and employees, and all persons acting on its or their behalf (collectively, "Vishay"), disclaim any and all liability for any errors, inaccuracies or incompleteness contained in any datasheet or in any other disclosure relating to any product.

Vishay makes no warranty, representation or guarantee regarding the suitability of the products for any particular purpose or the continuing production of any product. To the maximum extent permitted by applicable law, Vishay disclaims (i) any and all liability arising out of the application or use of any product, (ii) any and all liability, including without limitation special, consequential or incidental damages, and (iii) any and all implied warranties, including warranties of fitness for particular purpose, non-infringement and merchantability.

Statements regarding the suitability of products for certain types of applications are based on Vishay's knowledge of typical requirements that are often placed on Vishay products in generic applications. Such statements are not binding statements about the suitability of products for a particular application. It is the customer's responsibility to validate that a particular product with the properties described in the product specification is suitable for use in a particular application. Parameters provided in datasheets and / or specifications may vary in different applications and performance may vary over time. All operating parameters, including typical parameters, must be validated for each customer application by the customer's technical experts. Product specifications do not expand or otherwise modify Vishay's terms and conditions of purchase, including but not limited to the warranty expressed therein.

Except as expressly indicated in writing, Vishay products are not designed for use in medical, life-saving, or life-sustaining applications or for any other application in which the failure of the Vishay product could result in personal injury or death. Customers using or selling Vishay products not expressly indicated for use in such applications do so at their own risk. Please contact authorized Vishay personnel to obtain written terms and conditions regarding products designed for such applications.

No license, express or implied, by estoppel or otherwise, to any intellectual property rights is granted by this document or by any conduct of Vishay. Product names and markings noted herein may be trademarks of their respective owners.