

Isolation Power Transformers

Toroid Platform SMD

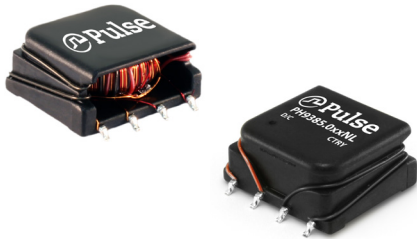

- Push Pull Converter Transformer
- Designed to provide isolated power for RS-485, CAN, ModBus transceiver and other communication interfaces
- Patent Pending Sidecar Construction
- IEC 60950 and 61558 basic insulation compliant, 12mm creepage
- 4KVrms isolation, 600Vrms rated

Electrical Specifications @ 25°C - Operating Temperature -40°C to +125°C

Part Number	Inductance (1-4) ($\mu\text{H} \pm 35\%$)	Leakage Inductance (1-4) with (5-8) shorted ($\mu\text{H} \text{ MAX}$)	Capacitance (1, 4) to (5, 8) (pF MAX)	DCR (1-4) ($\Omega \text{ MAX}$)	DCR (5-8) ($\Omega \text{ MAX}$)	MAX (1-4) ² (V- $\mu\text{sec} \text{ Max}$)	Turns Ratio (1:4) (8:5)	Isolated Voltage (Vrms)
PH9385.011NL	3200	6.0	36	1.10	1.00	109	1CT : 1CT	4000
PH9385.045NL	3200	4.0	36	1.10	1.25	109	4CT : 5CT	
PH9385.034NL	2600	3.0	36	1.00	1.50	98	3CT : 4CT	
PH9385.012NL	2600	3.0	40	1.00	1.90	98	1CT : 2CT	
PH9385.030NL	2600	3.0	40	1.00	2.20	98	3CT : 8CT	
PH9385.013NL	2600	3.0	40	1.00	2.75	98	1CT : 3CT	
PH9385.027NL	2600	3.0	40	1.00	3.00	98	2CT : 7CT	
PH9385.015NL	1350	3.0	30	0.80	3.20	70	1CT : 5CT	

Notes:

- Pins 1-4 (connect 2 & 3), Pins 8-5 (connect 6 & 7)
- The maximum volt-use rating limits the peak flux density to 3600 gauss when used in bi-polar drive application with 200KHz. For unipolar drive applications or a bi-polar drive with 350KHz, a maximum volt-use could be 60% of the listed value. For Push-Pull topology, where the voltage is applied across half the primary winding turns, the maximum volts-use needs to be derated by 50%.
- Optional Tape & Reel packing can be ordered by adding a "T" suffix to the part number (i.e. PH9385.011NL becomes PH9385.011NLT). Pulse complies to industry standard tape and reel specification EIA481.
- The "NL" suffix indicates an RoHS-compliant part number.
- The temperature of the component (ambient plus temperature rise) must be within the stated operating temperature range.

Mechanical

Schematic

PH9385.0XXNL

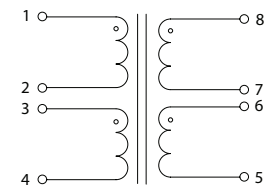
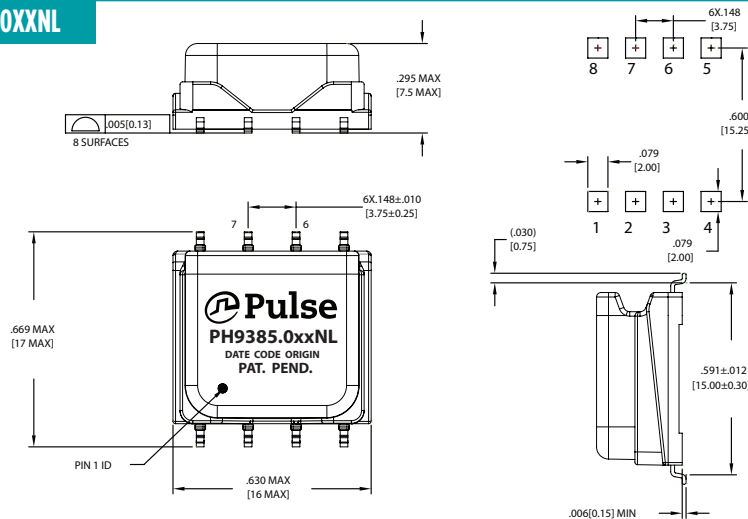

Weight2.5/grams
Tape & Reel300/reel
Tray80/tray

Dimensions: Inches
mm

Unless otherwise specified,
all tolerances are $\pm \frac{.010}{0,25}$

USA 858 674 8100

Germany 49 7032 7806 0

Singapore 65 6287 8998

Shanghai 86 21 62787060

China 86 755 33966678

Taiwan 886 3 4356768

Isolation Power Transformers

Toroid Platform SMD

Application

PH9385NL is a series of high isolation power supply transformer drivers. Intended to operate in a fixed duty cycle Push Pull topology, it is a part of a low cost solution for delivering lower power (up to 2.5W) from a low voltage source. A typical implementation would be an isolated RS-485 power supply driver circuit, the design is compatible with the MAXIM™ MAX253 IC. Other IC's include Texas SN6501 UCC2808, Analog ADuM4070, ADuM447x.

A schematic diagram for the Push Pull converter topology is given below.

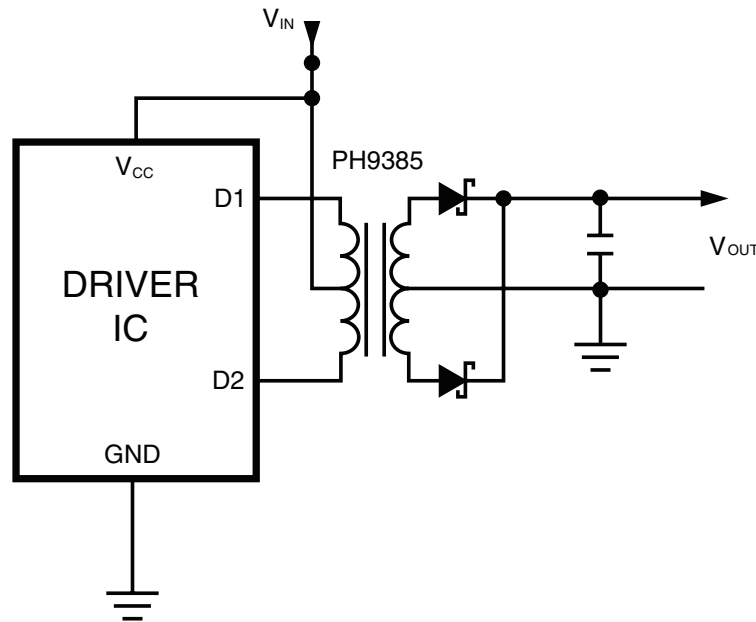

For a fixed 50% duty cycle mode of operation, the output voltage is simply determined by the input voltage and turns ratio. So, with the available turns ratios, a variety of output voltages can be selected. This range can be extended by implementing different topologies such as forward or bridge and can be used with controllers offered by different IC vendors for a number of different applications.

For More Information

Pulse Worldwide Headquarters

12220 World Trade Drive
San Diego, CA 92128
U.S.A.

Tel: 858 674 8100
Fax: 858 674 8262

Pulse Europe

Einsteinstrasse 1
D-71083 Herrenberg
Germany

Tel: 49 7032 7806 0
Fax: 49 7032 7806 135

Pulse China Headquarters

B402, Shenzhen Academy of
Aerospace Technology Bldg.
10th Kejinan Road
High-Tech Zone
Nanshan District
Shenzhen, PR China 518057

Tel: 86 755 33966678
Fax: 86 755 33966700

Pulse North China

Room 2704/2705
Super Ocean Finance Ctr.
2067 Yan An Road West
Shanghai 200336
China

Tel: 86 21 62787060
Fax: 86 2162786973

Pulse South Asia

135 Joo Seng Road
#03-02
PM Industrial Bldg.
Singapore 368363

Tel: 65 6287 8998
Fax: 65 6287 8998

Pulse North Asia

3F, No. 198
Zhongyuan Road
Zhongli City
Taoyuan County 320
Taiwan R. O. C.

Tel: 886 3 4356768
Fax: 886 3 4356823 (Pulse)
Fax: 886 3 4356820 (FRE)

Performance warranty of products offered on this data sheet is limited to the parameters specified. Data is subject to change without notice. Other brand and product names mentioned herein may be trademarks or registered trademarks of their respective owners. © Copyright, 2016. Pulse Electronics, Inc. All rights reserved.