



# PCL/PCLH series

## 3A, 5A, 10A, 15A General Purpose Miniature Relay

Factory Automation, Process Controls,  
Electrical Panels, etc.

UL File No. E58304

CSA File No. LR48471

Users should thoroughly review the technical data before selecting a product part number. It is recommended that user also seek out the pertinent approvals files of the agencies/laboratories and review them to ensure the product meets the requirements for a given application.

### Features

- Small size, 3A, 5A, 10A and 15A switching capacity.
- Meets UL and CSA requirements.
- 1 pole, 2 poles and 4 poles contact arrangements.
- AC and DC coils with UL Class F (155°C) coil insulation system standard.
- Optional flange mount case.
- Plug-in terminals or PCB terminals.

### Contact Data @ 20°C

**Arrangements:** 1 Form A (SPST-NO), 1 Form C (SPDT),  
2 Form A (DPST-NO), 2 Form C (DPDT),  
4 Form A (4PST-NO), 4 Form C (4PDT).

**Material:** Ag, Ag Alloy.

**Max. Switching Rate:** 300ops./min. (Mechanical).  
30ops./min. (Electrical).

**Expected Mechanical Life:** 100 million operations (no load).

**Expected Electrical Life:** 100,000 operations (rated load).

**Minimum Load:** 100mA @ 5VDC.

**Initial Contact Resistance:** 50milliohms @ DC6V,1A.

### Contact Ratings

**Ratings:** PCL-4 3A @ AC250V/DC24V resistive.  
PCL-2 5A @ AC250V/DC24V resistive.  
PCLH-2 15A @ AC120V resistive.  
10A @ AC250V/DC24V resistive.  
PCLH-1 15A @ AC250V/DC24V resistive.

**Max. Switched Current:** PCL-4 3A.  
PCL-2 5A.  
PCLH-2 15A.  
PCLH-1 15A.

**Max. Switched Power:** PCL-4 660VA, 72W.  
PCL-2 1,100VA, 120W.  
PCLH-2 3,168VA, 240W.  
PCLH-1 3,300VA, 360W.

### Initial Dielectric Strength

**Between Open Contacts:** 1,000VAC 1minute.

**Between Adjacent Contact Terminals:** 1,500VAC 1minute.

**Between Contacts and Coil:** 2,000VAC 1minute.

**Surge Voltage (Coil-Contact):** 3,000V(1.2/50µs).

### Initial Insulation Resistance

**Between Open Contacts:** 1,000Mohms @ 500VDC.

**Between Adjacent Contact Terminals:** 1,000Mohms @ 500VDC.

**Between Contacts and Coil:** 1,000Mohms @ 500VDC.

### Coil Data

**Voltage:** AC 6 - 240V.  
DC 6 - 110V.

**Nominal Power:** AC abt. 1.4VA/1.2VA (50Hz/60Hz).  
DC abt. 0.9W.

**Coil Temperature Rise:** AC 60°C max.  
DC 50°C max.

**Max. Coil Power:** 110% of nominal voltage.

### Coil Data @ 20°C

PCL AC Coil				
Rated Coil Voltage (VAC)	Coil Resistance (ohms)±10%	Must Operate Voltage (VAC)	Must Release Voltage (VAC)	Nominal Coil Power (VA)
6	10	80% max.	30% min.	abt. 1.4
12	40			
24	160			
48	600			
100	2,800			
110/120	3,400			
200	11,000			
220/240	13,600			
PCL DC Coil				
Rated Coil Voltage (VDC)	Coil Resistance (ohms)±10%	Must Operate Voltage (VDC)	Must Release Voltage (VDC)	Nominal Coil Power (W)
6	40	80% max.	10% min.	abt. 0.9
12	160			
24	650			
48	2,600			
100/110	11,000			abt. 1.1

### Operate Data @ 20°C

**Must Operate Voltage:** AC 80% of nominal voltage or less.  
DC 80% of nominal voltage or less.

**Must Release Voltage:** AC 30% of nominal voltage or more.  
DC 10% of nominal voltage or more.

**Operate Time:** AC 20ms max.  
DC 15ms max.

**Release Time:** AC 20ms max.  
DC 8ms max.

### Environmental Data

**Temperature Range:**

**Operating:** -10°C to +55°C.

**Humidity:** 45 to 85%. (Non-condensing).

**Vibration, Operational:** 10 to 55Hz 1.0mm double amplitude.

**Mechanical:** 10 to 55Hz 1.0mm double amplitude.

**Shock, Operational:** 100m/s<sup>2</sup> (abt. 10G).

**Mechanical:** 1,000m/s<sup>2</sup> (abt. 100G).

### Mechanical Data

**Termination:** Plug-in, PCB.

**Enclosure:** Snap-on cover.

**Weight:** 1.26 oz (32g) approximately.

**Ordering Information**

Typical Part Number		PCL	-2	02A	1	S	,000
<b>1. Basic Series:</b> PCL = 3A, 5A type    PCLH = 10A, 15A type							
<b>2. Number of Poles:</b> 1 = 1 pole (PCLH only)    2 = 2 pole    4 = 4 pole (PCL only)							
<b>3. Coil Voltage:</b> 01A=6VAC    02A=12VAC    03A=24VAC    04A=48VAC 05A=100VAC    06A=110/120VAC    07A=200VAC    08A=220/240VAC 01D=6VDC    02D=12VDC    03D=24VDC    04D=48VDC    05D=100/110VDC							
<b>4. Contact Material:</b> Blank = Ag (only available on 4 pole model)    1 = Ag Alloy (available with all versions)							
<b>5. Contact Arrangement:</b> Blank = Form C    M = Form A							
<b>6. Case Type:</b> S = Standard (Smoke color)    F = Flange mount (Smoke color)							
<b>7. Terminal Type:</b> Blank = Plug-in    P = PCB							
<b>8. Indicator Lamp:</b> Blank = None    L = Indicator Lamp							
<b>9. Option:</b> .000 = Standard model    Other suffix = Custom model.							

**Our authorized distributors are more likely to stock the following items for immediate delivery.**

- PCLH-202A1S,000
- PCLH-203A1S,000
- PCLH-206A1S,000
- PCLH-208A1S,000
- PCLH-202D1S,000
- PCLH-203D1S,000
- PCLH-204D1S,000
- PCLH-205D1S,000
- PCLH-206A1SP,000
- PCLH-202D1SP,000
- PCLH-203D1SP,000
- PCLH-205D1SP,000

**Outline Dimensions**

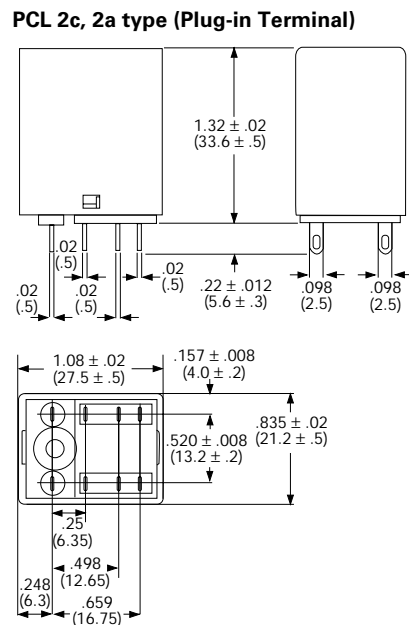
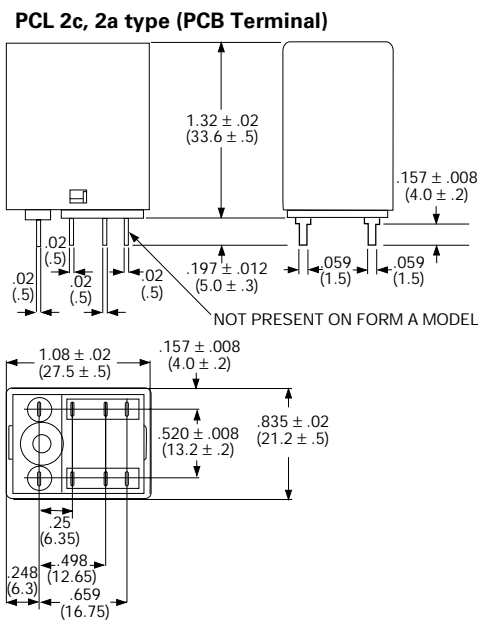

**Outline Dimensions (continued)**

**PCL 4c, 4a type (PCB Terminal)**

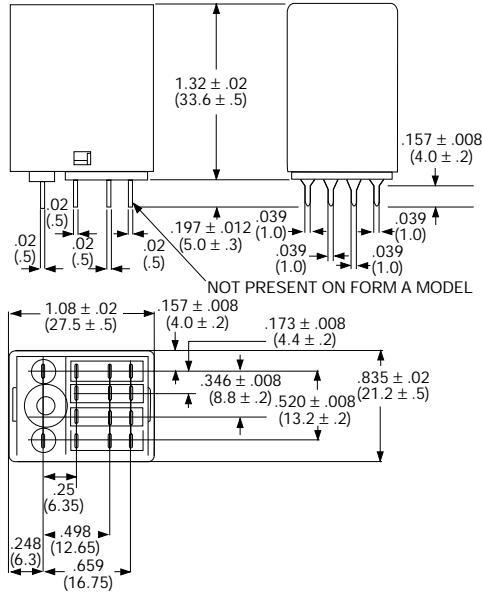

**PCL 4c, 4a type (Plug-in Terminal)**

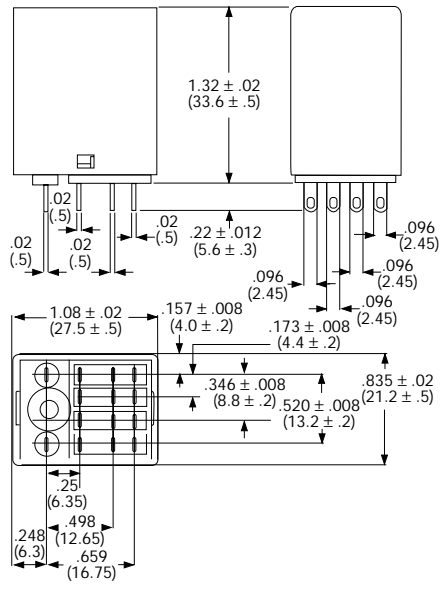

**PCLH type (PCB Terminal)**

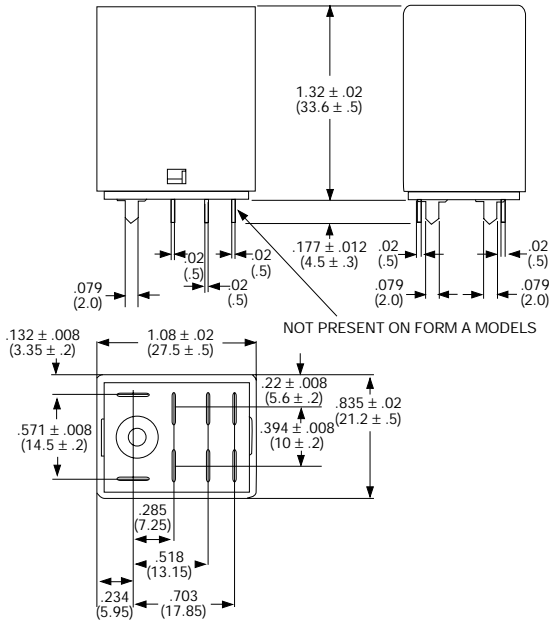

**PCLH type (Plug-in Terminal)**

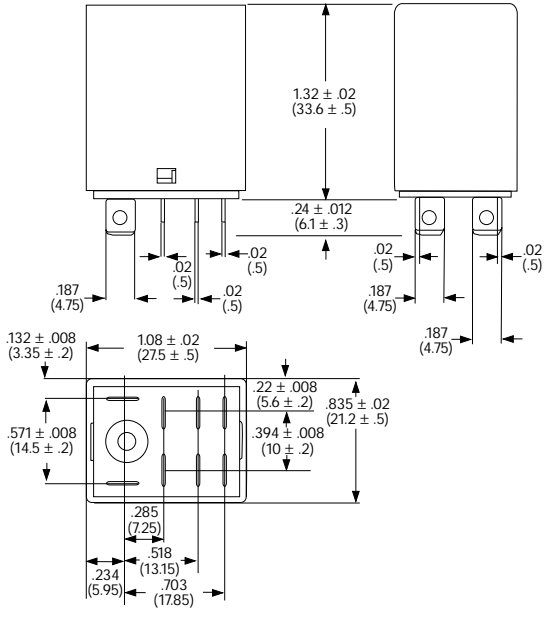

**PCLH type (Flange Mount Case)**

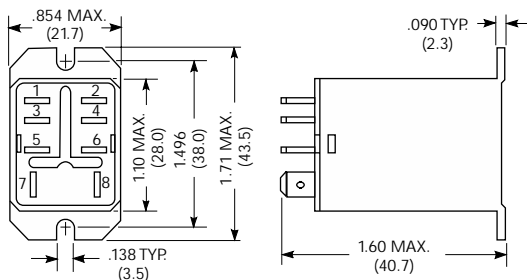

Dimensions are shown for reference purposes only.

Dimensions are in inches over (millimeters) unless otherwise specified.

Specifications and availability subject to change.

www.tycoelectronics.com  
Technical support:  
Refer to inside back cover.

