

# tPad

## User Manual

DE2-115 with LCD Touch Panel and Camera



**terasIC**  
www.terasic.com

**ALTERA**

Copyright © 2003-2010 Terasic Technologies Inc. All Rights Reserved.

<b>Chapter 1</b>	<b>Introduction of the tPad .....</b>	<b>2</b>
1.1	About the Kit .....	6
1.2	Getting Help .....	7
<b>Chapter 2</b>	<b>tPad Architecture .....</b>	<b>8</b>
2.1	Layout and Components .....	8
2.2	Block Diagram of the tPad .....	9
<b>Chapter 3</b>	<b>Using the tPad .....</b>	<b>10</b>
3.1	Configuring the Cyclone IV E FPGA .....	10
3.2	Bus Controller .....	13
3.3	Using the 8" LCD Touch Screen Module .....	14
3.4	Using 5-Megapixel Digital Image Sensor Module .....	15
3.5	Using the Digital Accelerometer .....	16
<b>Chapter 4</b>	<b>tPad Demonstrations.....</b>	<b>17</b>
4.1	System Requirements .....	17
4.2	Factory Configuration .....	17
4.3	tPad Starter Demonstration.....	18
4.4	tPad Picture Viewer .....	22
4.5	Video and Image Processing.....	25
4.6	tPad Camera Application .....	28
4.7	Video and Image Processing for Camera.....	31
4.8	tPad Digital Accelerometer Demonstration .....	35
<b>Chapter 5</b>	<b>Application Selector .....</b>	<b>38</b>
5.1	Ready to Run SD Card Demos .....	38
5.2	Running the Application Selector.....	39
5.3	Application Selector Details .....	39
5.4	Restoring the Factory Image .....	42
<b>Chapter 6</b>	<b>Appendix.....</b>	<b>44</b>
6.1	Revision History .....	44
6.2	Copyright Statement .....	44

## Chapter 1

# *Introduction of the tPad*

---

The tPad Embedded Evaluation Kit is a comprehensive design environment with everything embedded developers need to create processing-based systems. The tPad delivers an integrated platform that includes hardware, design tools, intellectual property (IP) and reference designs for developing embedded software and hardware platform in a wide range of applications. The fully integrated kit allows developers to rapidly customize their processor and IP to best suit their specific application. The tPad features the DE2-115 development board targeting the Cyclone IV E FPGA, as well as a LCD multimedia color touch panel and a 5-Megapixel digital image sensor module.

The tPad is preconfigured with an FPGA hardware reference design including several Ready-to-Run demonstration applications stored on the provided SD-Card. Software developers can use these reference designs as their platform to quickly architect, develop and build complex embedded systems. By simply scrolling through the demo of your choice on the LCD multimedia color touch panel, you can evaluate numerous processor system designs.

The all-in-one embedded solution offered on the tPad, in combination of the LCD touch panel and digital image module, provide embedded developers the ideal platform for multimedia applications with unparalleled processing performance. Developers can benefit from the use of FPGA-based embedded processing system such as mitigate design risk and obsolescence, design reuse, reducing bill of material (BOM) costs by integrating powerful graphics engines within the FPGA, and lower cost.

**Figure 1-1** shows a photograph of the tPad.



**Figure 1-1 The tPad board overview**

The key features of the board are listed below:

### ■ DE2-115 Development Board

- Cyclone IV EP4CE115 FPGA
  - 114,480 LEs
  - 432 M9K memory blocks
  - 3,888 Kbits embedded memory
  - 4 PLLs
- Configuration
  - On-board USB-Blaster circuitry
  - JTAG and AS mode configuration supported
  - EPCS64 serial configuration device
- Memory Devices
  - 128MB SDRAM
  - 2MB SRAM
  - 8MB Flash with 8-bit mode
  - 32Kbit EEPROM
- Switches and Indicators
  - 18 switches and 4 push-buttons
  - 18 red and 9 green LEDs
  - Eight 7-segment displays

- Audio
  - 24-bit encoder/decoder (CODEC)
  - Line-in, line-out, and microphone-in jacks
- Display
  - 16x2 LCD module
- On-Board Clocking Circuitry
  - Three 50MHz oscillator clock inputs
  - SMA connectors (external clock input/output)
- SD Card Socket
  - Provides SPI and 4-bit SD mode for SD Card access
- Two Gigabit Ethernet Ports
  - Integrated 10/100/1000 Gigabit Ethernet
- High Speed Mezzanine Card (HSMC)
  - Configurable I/O standards (voltage levels: 3.3/2.5/1.8/1.5V)
- USB Type A and B
  - Provide host and device controller compliant with USB 2.0
  - Support data transfer at full-speed and low-speed
  - PC driver available
- 40-pin Expansion Port
  - Configurable I/O standards (voltage levels: 3.3/2.5/1.8/1.5V)
- VGA-out Connector
  - VGA DAC (high speed triple DACs)
- DB9 Serial Connector
  - RS232 port with flow control
- PS/2 Connector
  - PS/2 connector for connecting a PS2 mouse or keyboard
- TV-in Connector
  - TV decoder (NTSC/PAL/SECAM)
- Remote Control
  - Infrared receiver module

- Power
  - Desktop DC input
  - Switching and step-down regulators LM3150MH

## ■ LCD touch screen module

- Equipped with an 8-inch Amorphous-TFT-LCD (Thin Film Transistor Liquid Crystal Display) module
- Module composed of LED backlight
- Support 18-bit parallel RGB interface
- Converting the X/Y coordination of touch point to its corresponding digital data via the Analog Devices AD7843 A/D converter

**Table 1-1** shows the general physical specifications of the LTC (Note\*).

**Table 1-1 General physical specifications of the LCD**

<i>Item</i>	<i>Specification</i>	<i>Unit</i>
<b>LCD size</b>	<b>8 inch (Diagonal)</b>	-
<b>Resolution</b>	<b>800 x3(RGB) x 600</b>	<b>dot</b>
<b>Dot pitch</b>	<b>0.0675(W) x 0.2025(H)</b>	<b>mm</b>
<b>Active area</b>	<b>162.0(W) x 121.5(H)</b>	<b>mm</b>
<b>Module size</b>	<b>183.0(W) x 141.0(H) x 7.2(D)</b>	<b>mm</b>
<b>Surface treatment</b>	<b>Anti-Glare</b>	-
<b>Color arrangement</b>	<b>RGB-stripe</b>	-
<b>Interface</b>	<b>Digital</b>	-

## ■ 5-Megapixel digital image sensor module

- Superior low-light performance
- High frame rate
- Low dark current
- Global reset release, which starts the exposure of all rows simultaneously
- Bulb exposure mode, for arbitrary exposure times
- Snapshot mode to take frames on demand
- Horizontal and vertical mirror image
- Column and row skip modes to reduce image size without reducing field-of-view
- Column and row binning modes to improve image quality when resizing
- Simple two-wire serial interface
- Programmable controls: gain, frame rate, frame size, exposure

**Table 1-2** shows the key parameters of the CMOS sensor (Note\*).

**Table 1-2 Key performance parameters of the CMOS sensor**

Parameter		Value
Active Pixels		2592Hx1944V
Pixel size		2.2umx2.2um
Color filter array		RGB Bayer pattern
Shutter type		Global reset release(GRR)
Maximum data rate/master clock		96Mp/s at 96MHz
Frame rate	Full resolution	Programmable up to 15 fps
	VGA mode	Programmable up to 70 fps
ADC resolution		12-bit
Responsivity		1.4V/lux-sec(550nm)
Pixel dynamic range		70.1dB
SNRMAX		38.1dB
Supply Voltage	Power	3.3V
	I/O	1.7V~3.1V

## ■ Digital Accelerometer

- Up to 13-bit resolution at +/- 16g
- SPI (3- and 4-wire) digital interface
- Flexible interrupts modes



*Note: for more detailed information of the LCD touch panel and CMOS sensor module, please refer to their datasheets respectively.*

## 1.1 About the Kit

The kit contains all users needed to run the demonstrations and develop custom designs, as shown in [Figure 1-2](#).

The system CD contains technical documents of the tPad which includes component datasheets, demonstrations, schematic, and user manual.



Figure 1-2 tPad kit package contents

## 1.2 Getting Help

Here is information of how to get help if you encounter any problem:

- Terasic Technologies
- Tel: +886-3-550-8800
- Email: [support@terasic.com](mailto:support@terasic.com)



## Chapter 2

# *tPad Architecture*

This chapter describes the architecture of the tPad including block diagram and components.

### 2.1 Layout and Components

The picture of the tPad is shown in **Figure 2-1** and **Figure 2-2**. It depicts the layout of the board and indicates the locations of the connectors and key components.



**Figure 2-1 tPad PCB and component diagram (top view)**

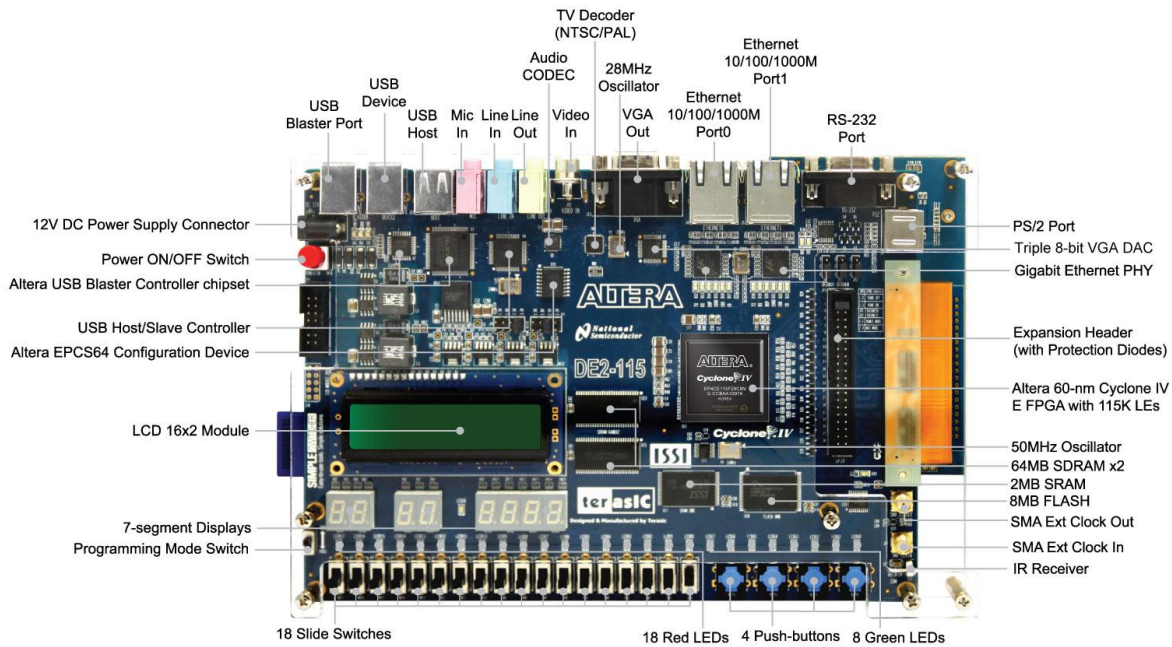

Figure 2-2 tPad PCB and component diagram (bottom view)

## 2.2 Block Diagram of the tPad

Figure 2-3 gives the block diagram of the tPad board. To provide maximum flexibility for the user, all connections are made through the Cyclone IV E FPGA device. Thus, the user can configure the FPGA to implement any system design.

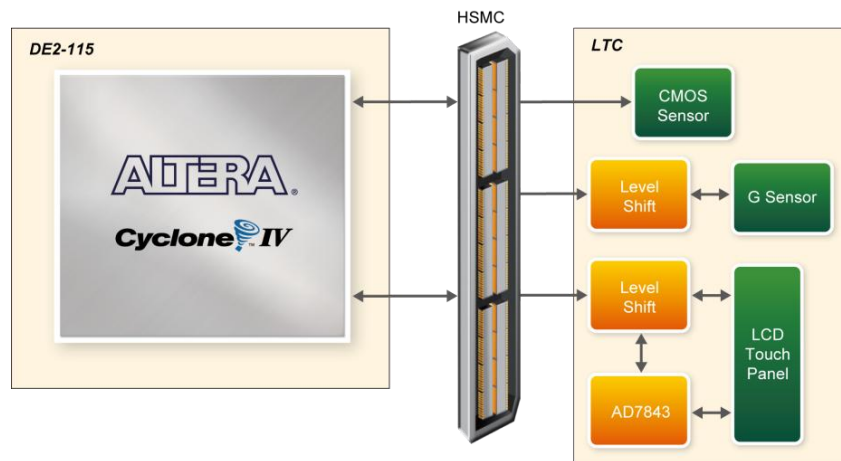

Figure 2-3 Block Diagram of tPad

## Chapter 3

# *Using the tPad*

This section describes the detailed information of the components, connectors, and pin assignments of the tPad.

### 3.1 Configuring the Cyclone IV E FPGA

The tPad board contains a serial configuration device that stores configuration data for the Cyclone IV E FPGA. This configuration data is automatically loaded from the configuration device into the FPGA every time while power is applied to the board. Using the Quartus II software, it is possible to reconfigure the FPGA at any time, and it is also possible to change the non-volatile data that is stored in the serial configuration device. Both types of programming methods are described below.

1. JTAG programming: In this method of programming, named after the IEEE standards Joint Test Action Group, the configuration bit stream is downloaded directly into the Cyclone IV E FPGA. The FPGA will retain this configuration as long as power is applied to the board; the configuration information will be lost when the power is turned off.
2. AS programming: In this method, called Active Serial programming, the configuration bit stream is downloaded into the Altera EPCS64 serial configuration device. It provides non-volatile storage of the bit stream, so that the information is retained even when the power supply to the tPad board is turned off. When the board's power is turned on, the configuration data in the EPCS64 device is automatically loaded into the Cyclone IV E FPGA.

#### ■ JTAG Chain on tPad Board

To use JTAG interface for configuring FPGA device, the JTAG chain on the tPad must form a close loop that allows Quartus II programmer to detect the FPGA device. **Figure 3-1** illustrates the JTAG chain on the tPad board. Shorting pin1 and pin2 on JP3 can disable the JTAG signals on the HSMC connector that will form a close JTAG loopback on DE2-115 (See **Figure 3-2**). Thus, only the on board FPGA device (Cyclone IV E) will be detected by Quartus II programmer. By default, a jumper is placed on pin1 and pin3 of JP3. To prevent any changes to the bus controller (Max II EPM240) described in later sections, users should not adjust the jumper on JP3.

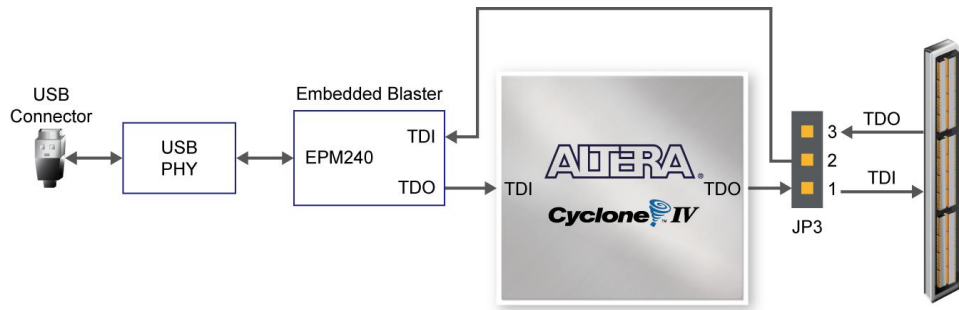

Figure 3-1 JTAG Chain

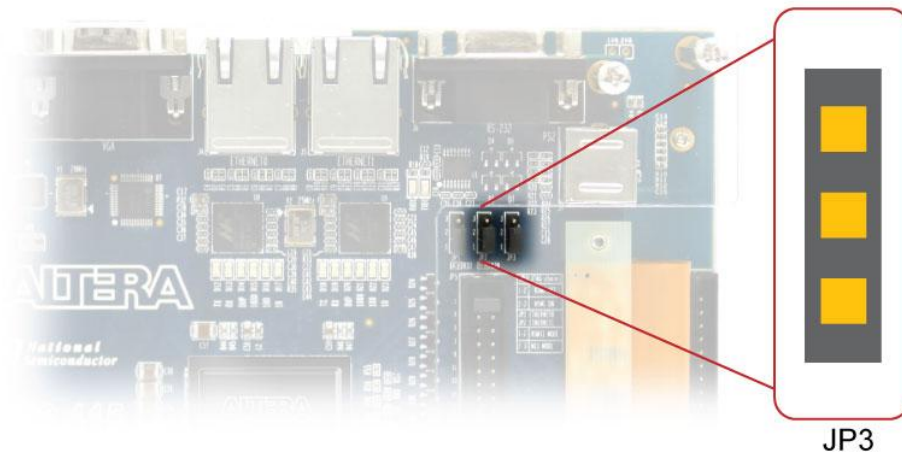

Figure 3-2 The JTAG chain configuration header

## ■ Configuring the FPGA in JTAG Mode

Figure 3-3 illustrates the JTAG configuration setup. To download a configuration bit stream into the Cyclone IV E FPGA, perform the following steps:

- Ensure that power is applied to the tPad board
- Configure the JTAG programming circuit by setting the RUN/PROG slide switch (SW19) to the RUN position (See Figure 3-4)
- Connect the supplied USB cable to the USB-Blaster port on the tPad board
- The FPGA can now be programmed by using the Quartus II Programmer module to select a configuration bit stream file with the .sof filename extension

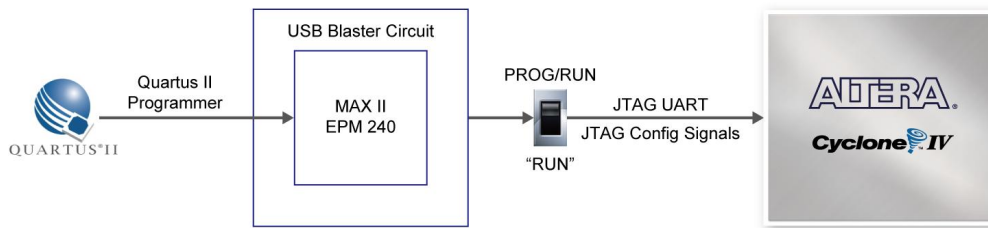

Figure 3-3 The JTAG chain configuration scheme

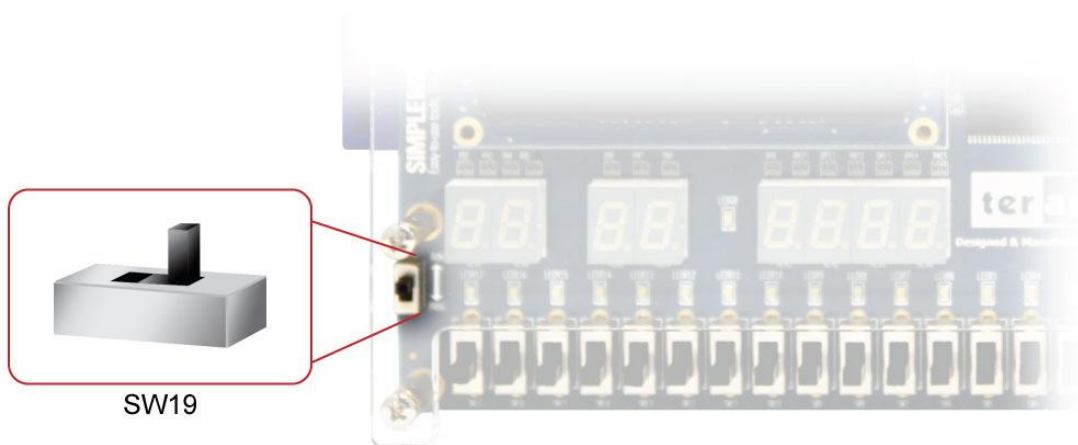

Figure 3-4 The RUN/PROG switch (SW19) is set to JTAG mode

## ■ Configuring the EPCS64 in AS Mode

Figure 3-5 illustrates the AS configuration set up. To download a configuration bit stream into the EPCS64 serial configuration device, perform the following steps:

- Ensure that power is applied to the tPad board
- Connect the supplied USB cable to the USB-Blaster port on the tPad board
- Configure the JTAG programming circuit by setting the RUN/PROG slide switch (SW19) to the PROG position
- The EPCS64 chip can now be programmed by using the Quartus II Programmer module to select a configuration bit stream file with the .pof filename extension
- Once the programming operation is finished, set the RUN/PROG slide switch back to the RUN position and then reset the board by turning the power switch off and back on; this action causes the new configuration data in the EPCS64 device to be loaded into the FPGA chip

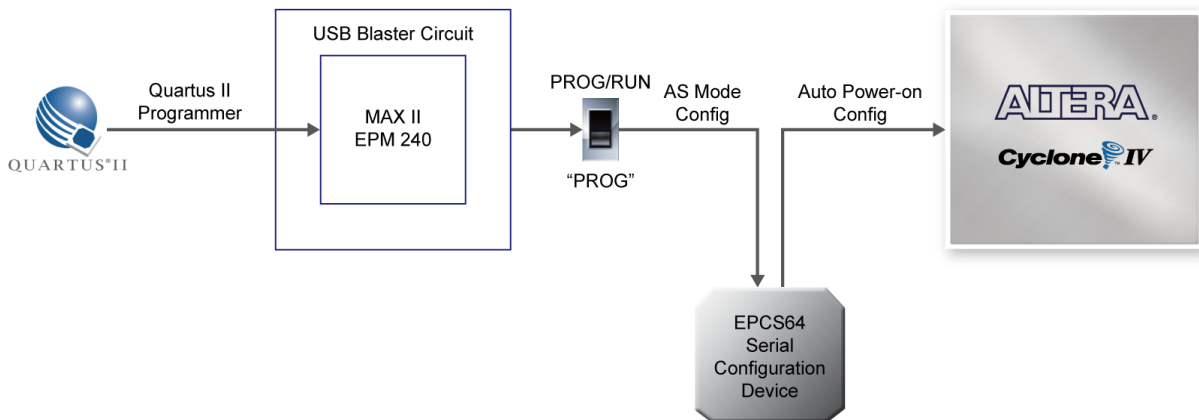

Figure 3-5 The AS configuration scheme

## 3.2 Bus Controller

The tPad comes with a bus controller using the Max II EPM240 that allows user to access the touch screen module through the HSMC connector. This section describes its structure in block diagram form and its capabilities.

### ■ Bus Controller Introduction

The bus controller provides level shifting functionality from 2.5V (HSMC) to 3.3V domains.

### ■ Block Diagram of the Bus Controller

Figure 3-6 gives the block diagram of the connection setup from the HSMC connector to the bus controller on the Max II EPM240 to the touch screen module. To provide maximum flexibility for the user, all connections are established through the HSMC connector. Thus, the user can configure the Cyclone IV E FPGA on the tPad to implement any system design.



Figure 3-6 Block Diagram of the Bus Controller

### 3.3 Using the 8" LCD Touch Screen Module

The tPad features an 8-inch Amorphous-TFT-LCD panel. The LCD Touch Screen module offers resolution of (800x600) to provide users the best display quality for developing applications. The LCD panel supports 18-bit parallel RGB data interface.

The tPad is also equipped with an Analog Devices AD7843 touch screen digitizer chip. The AD7843 is a 12-bit analog to digital converter (ADC) for digitizing x and y coordinates of touch points applied to the touch screen. The coordinates of the touch points can be read through the serial port interface on the AD7843.

To display images on the LCD panel correctly, the RGB color data along with the data enable and clock signals must act according to the timing specification of the LCD touch panel as shown in **Table 3-1**.

**Table 3-2** gives the pin assignment information of the LCD touch panel.

**Table 3-1 LCD timing specifications**

Parameter	Symbol	Values			Unit
		Min.	Typ.	Max.	
CLK Frequency	FCPH	-	39.79	-	MHz
CLK Period	FCPH	-	25.13	-	Ns
CLK Pulse Duty	FCWH	40	50	60	%
DE Period	FDEH+ TDEL	1000	1056	-	TCPH
DE Pulse Width	FDH	-	800	-	TCPH
DE Frame Blanking	FHS	10	28	110	FDEH+TDEL
DE Frame Width	FEP	-	600	-	FDEH+TDEL
OEV Pulse Width	TOEV	-	150	-	TCPH
OKV Pulse Width	TCKV	-	133	-	TCPH
DE(internal)-STV Time	T1	-	4	-	TCPH
DE(internal)-CKV Time	T2	-	40	-	TCPH
DE(internal)-OEV Time	T3	-	23	-	TCPH
DE(internal)-POL Time	T4	-	157	-	TCPH
STV Pulse Width	-	-	1	-	TH

*Note: THS + THA < TH*

**Table 3-2 Pin assignment of the LCD touch panel**

Signal Name	FPGA Pin No.	Description	I/O Standard
LCD_DIM	PIN_P27	LCD backlight enable	2.5V
LCD_NCLK	PIN_V24	LCD clock	2.5V
LCD_R0	PIN_V26	LCD red data bus bit 0	2.5V
LCD_R1	PIN_R27	LCD red data bus bit 1	2.5V

LCD_R2	PIN_R28	LCD red data bus bit 2	2.5V
LCD_R3	PIN_U27	LCD red data bus bit 3	2.5V
LCD_R4	PIN_U28	LCD red data bus bit 4	2.5V
LCD_R5	PIN_V27	LCD red data bus bit 5	2.5V
LCD_G0	PIN_P21	LCD green data bus bit 0	2.5V
LCD_G1	PIN_R21	LCD green data bus bit 1	2.5V
LCD_G2	PIN_R22	LCD green data bus bit 2	2.5V
LCD_G3	PIN_R23	LCD green data bus bit 3	2.5V
LCD_G4	PIN_T21	LCD green data bus bit 4	2.5V
LCD_G5	PIN_T22	LCD green data bus bit 5	2.5V
LCD_B0	PIN_V28	LCD blue data bus bit 0	2.5V
LCD_B1	PIN_U22	LCD blue data bus bit 1	2.5V
LCD_B2	PIN_V22	LCD blue data bus bit 2	2.5V
LCD_B3	PIN_V25	LCD blue data bus bit 3	2.5V
LCD_B4	PIN_L28	LCD blue data bus bit 4	2.5V
LCD_B5	PIN_J26	LCD blue data bus bit 5	2.5V
LCD_DEN	PIN_P25	LCD RGB data enable	2.5V
TOUCH_PENIRQ_N	PIN_L22	AD7843 pen interrupt	2.5V
TOUCH_DOUT	PIN_L21	AD7843 serial interface data out	2.5V
TOUCH_BUSY	PIN_U26	AD7843 serial interface busy	2.5V
TOUCH_DIN	PIN_U25	AD7843 serial interface data in	2.5V
TOUCH_CS_N	PIN_T26	AD7843 serial interface chip select input	2.5V
TOUCH_DCLK	PIN_T25	AD7843 interface clock	2.5V

### 3.4 Using 5-Megapixel Digital Image Sensor Module

The tPad is equipped with a 5-Megapixel digital image sensor module that provides an active imaging array of 2,592H x 1,944V. It features low-noise CMOS imaging technology that achieves CCD image quality. In addition, it incorporates sophisticated camera functions on-chip such as windowing, column and row skip mode, and snapshot mode.

The sensor can be operated in its default mode or programmed by the user through a simple two-wire serial interface for frame size, exposure, gain settings, and other parameters. **Table 3-3** contains the pin names and descriptions of the image sensor module.

**Table 3-3 Pin assignment of the CMOS sensor**

<i>Signal Name</i>	<i>FPGA Pin No.</i>	<i>Description</i>	<i>I/O Standard</i>
CAMERA_PIXCLK	PIN_J27	Pixel clock	2.5V
CAMERA_D0	PIN_F26	Pixel data bit 0	2.5V
CAMERA_D1	PIN_E26	Pixel data bit 1	2.5V
CAMERA_D2	PIN_G25	Pixel data bit 2	2.5V



CAMERA_D3	PIN_G26	Pixel data bit 3	2.5V
CAMERA_D4	PIN_H25	Pixel data bit 4	2.5V
CAMERA_D5	PIN_H26	Pixel data bit 5	2.5V
CAMERA_D6	PIN_K25	Pixel data bit 6	2.5V
CAMERA_D7	PIN_K26	Pixel data bit 7	2.5V
CAMERA_D8	PIN_L23	Pixel data bit 8	2.5V
CAMERA_D9	PIN_L24	Pixel data bit 9	2.5V
CAMERA_D10	PIN_M25	Pixel data bit 10	2.5V
CAMERA_D11	PIN_M26	Pixel data bit 11	2.5V
CAMERA_STROBE	PIN_G28	Snapshot strobe	2.5V
CAMERA_LVAL	PIN_K27	Line valid	2.5V
CAMERA_FVAL	PIN_K28	Frame valid	2.5V
CAMERA_RESET_N	PIN_M28	Image sensor reset	2.5V
CAMERA_SCLK	PIN_K22	Serial clock	2.5V
CAMERA_TRIGGER	PIN_H23	Snapshot trigger	2.5V
CAMERA_SDATA	PIN_H24	Serial data	2.5V
CAMERA_XCLKIN	PIN_G23	External input clock	2.5V

### 3.5 Using the Digital Accelerometer

The tPad is equipped with a digital accelerometer sensor module, the ADXL345 is a small, thin, ultralow power assumption 3-axis accelerometer with high resolution measurement. Digitalized output is formatted as 16-bit twos complement and could be accessed either using SPI interface or I2C interface. This chip uses the 3.3V CMOS signaling standard. Main applications include medical instrumentation, industrial instrumentation, personal electronic aid and hard disk drive protection etc. Some of the key features of this device are listed below. For more detailed information of better using this chip, please refer to its datasheet which is available on manufacturer's website or under the /datasheet folder of the system CD.

**Table 3-4** contains the pin names and descriptions of the G sensor module.

<i>Signal Name</i>	<i>FPGA Pin No.</i>	<i>Description</i>	<i>I/O Standard</i>
GSENSOR_INT1	PIN_AE26	Interrupt 1 output	2.5V
GSENSOR_INT2	PIN_AE27	Interrupt 2 output	2.5V
GSENSOR_CS_n	PIN_D28	Chip Select	2.5V
GSENSOR_ALT_ADDR	PIN_E27	I2C Address Select	2.5V
GSENSOR_SDA_SDI_SDIO	PIN_E28	Serial Data	2.5V
GSENSOR_SCL_SCLK	PIN_F27	Serial Communications Clock	2.5V

## Chapter 4

# *tPad Demonstrations*

This chapter gives detailed description of the provided bundles of exclusive demonstrations implemented on tPad. These demonstrations are particularly designed (or ported) for tPad, with the goal of showing the potential capabilities of the kit and showcase the unique benefits of FPGA-based SOPC systems such as reducing BOM costs by integrating powerful graphics and video processing circuits within the FPGA.

### 4.1 System Requirements

To run and recompile the demonstrations, you should:

- Install Altera Quartus II 10.0 and NIOS II EDS 10.0 or later edition on the host computer
- Install the USB-Blaster driver software. You can find instructions in the tutorial “Getting Started with Altera’s DE2-115 Board” (tut\_initialDE2-115.pdf) which is available on the DE2-115 system CD
- Copy the entire demonstrations folder from the tPad system CD to your host computer

### 4.2 Factory Configuration

The tPad development kit comes preconfigured with a default utility that boots up on power on and allows users to quickly select, load, and run different Ready-to-Run demonstrations stored on an SD Card using the tPad touch panel. **Figure 4-1** gives a snapshot of the default application selector interface (Note\*). Every demonstration consists of a FPGA hardware image and an application software image. When you select a demonstration the application selector copies the hardware image to EPCS device and software image to flash memory and reconfigures the FPGA with your selection. For more comprehensive information of the application selector factory configuration, please refer to chapter 5.

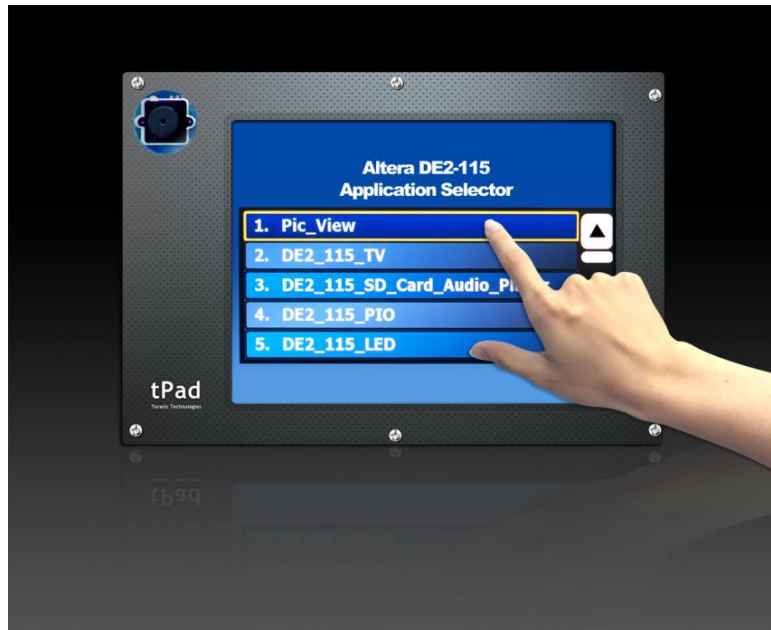

Figure 4-1 Application selector interface



*Note: Please insert the supplied SD Card from this demonstration.*

### 4.3 tPad Starter Demonstration

The tPad starter demonstration takes user the initial experience of an embedded system integrating a LCD Touch Panel. This demonstration consists of two sub item, Touch and Color pattern generator. The Touch segment draws a circle on where you touch the screen and updates its coordinates on the top left corner. The pattern generator can be treated as an upgrade version of the LCD test program. The software successively generates different color patterns after a fixed time delay. Users could use it to quickly investigate any flaw of the LCD.

**Figure 4-2** shows the hardware system block diagram of this demonstration. The system is clocked by an external 50MHz Oscillator. Through the internal PLL module, the generated 100MHz clock is used for Nios II processor and other components, and there also a 40MHz pixel clock for the video pipeline and 10MHz for low-speed peripherals. The Nios II CPU runs the application software and controls all the peripherals. A scatter-gather DMA is used to transfer pixel data from the video buffer to the video pipeline.

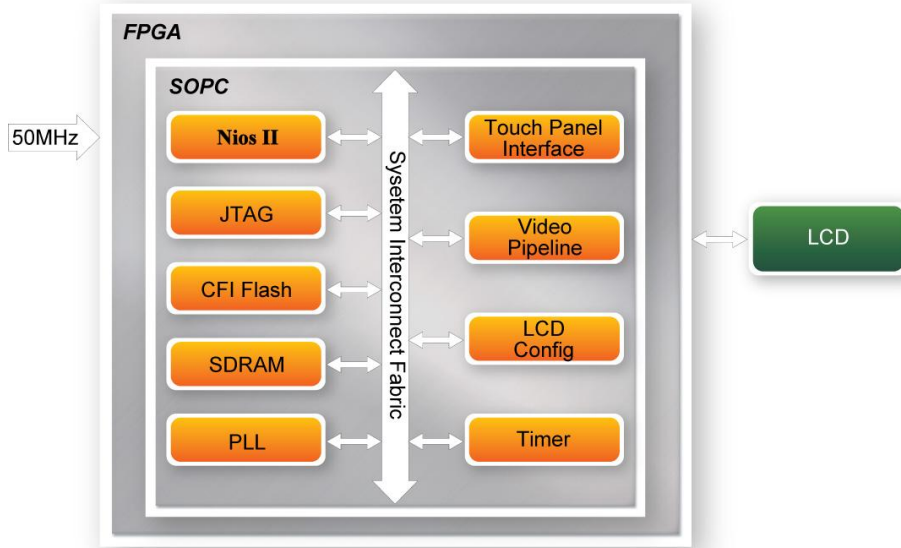

Figure 4-2 Block diagram of the tPad Starter demonstration

Figure 4-3 illustrates the software structure of this demonstration. The touch panel's SPI HAL block responds to the bottom hardware requests and interface to upper layers. The SGDMA HAL allocates required frame/descriptor buffers to specified memory address and is responsible of handling frame buffer update issue.



Figure 4-3 Software stack of the tPad Starter demonstration

## ■ Demonstration Source Code

- Project directory: tPad\_Starter
- Bit stream used: tPad\_Starter.sof
- Nios II Workspace: tPad\_Starter\Software

## ■ Demonstration Batch File

Demo Batch File Folder:tPad\_Starter\demo\_batch

The demo batch file includes the following files:

- Batch File: tPad\_Starter.bat, tPad\_Starter\_bashrc
- FPGA Configure File: tPad\_Starter.sof
- Nios II Program: tPad\_Starter.elf

## ■ Demonstration Setup

- Make sure Quartus II and Nios II are installed on your PC
- Power on the DE2-115 board
- Connect USB-Blaster to the DE2-115 board and install USB-Blaster driver if necessary
- Execute the demo batch file “tPad\_Starter.bat” under the batch file folder, tPad\_Starter\demo\_batch
- After Nios II program is downloaded and executed successfully, a prompt message will be displayed in nios2-terminal
- From on the touch panel, tap any icon of the main interface and start the experience, as shown in **Figure 4-4**, **Figure 4-5** and **Figure 4-6**
- Under each sub item, touch the **Exit** button on the left bottom corner will lead you back to the main interface



Figure 4-4 Main interface of the tPad Starter demonstration

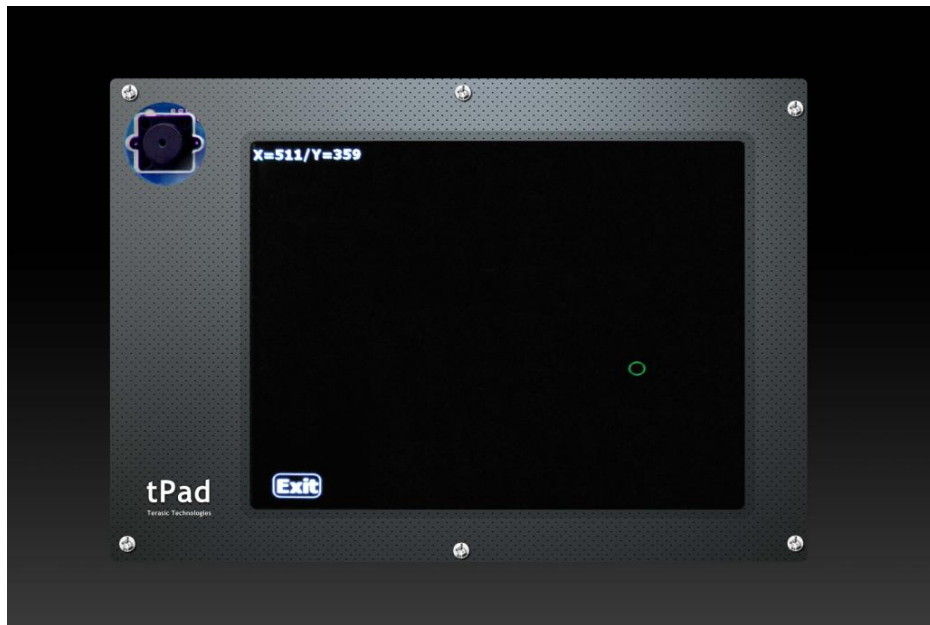

Figure 4-5 The tPad Starter Touch sub item

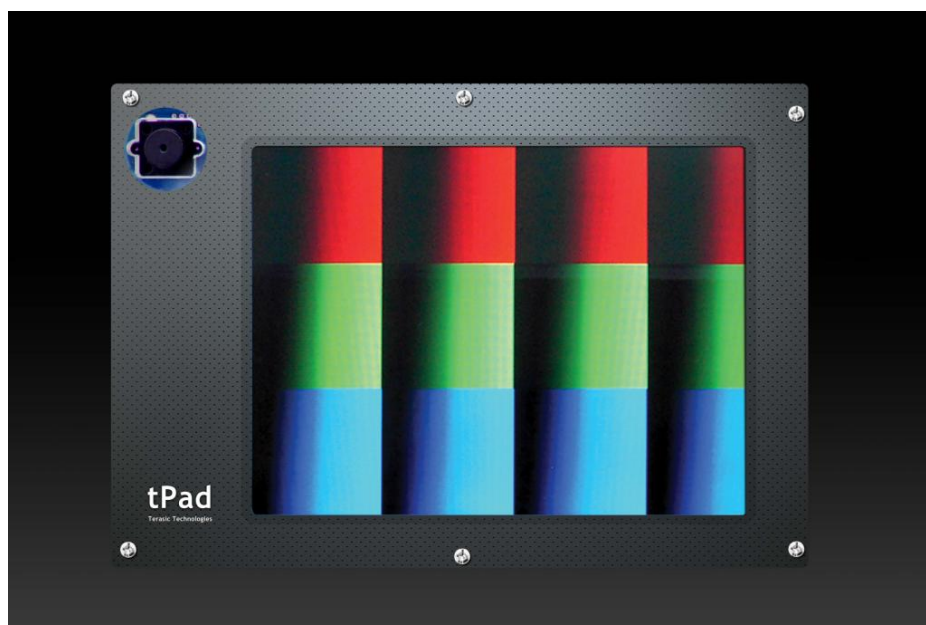

Figure 4-6 The tPad Starter Pattern sub item

## 4.4 tPad Picture Viewer

This demonstration shows a simple picture viewer implementation using Nios II based SOPC system. It reads JPEG images stored on SD Card and displays them on the LCD. The Nios II CPU decodes the images and fills the raw result data into frame buffers in SDRAM. The tPad will show the image the buffer being displayed points to. When users touch the LCD Touch Panel, it will proceed to display the next buffered image until there is no filled buffer and enter the **Loading** phase. **Figure 4-7** shows the block diagram of this demonstration.

The Nios II CPU here takes a key roll in the demonstration. It is responsible of decoding the JPEG images and coordinates the works of all the peripherals. The touch panel handling program uses the timer as a regular interrupter and periodically updates the pen state and sampled coordinates.

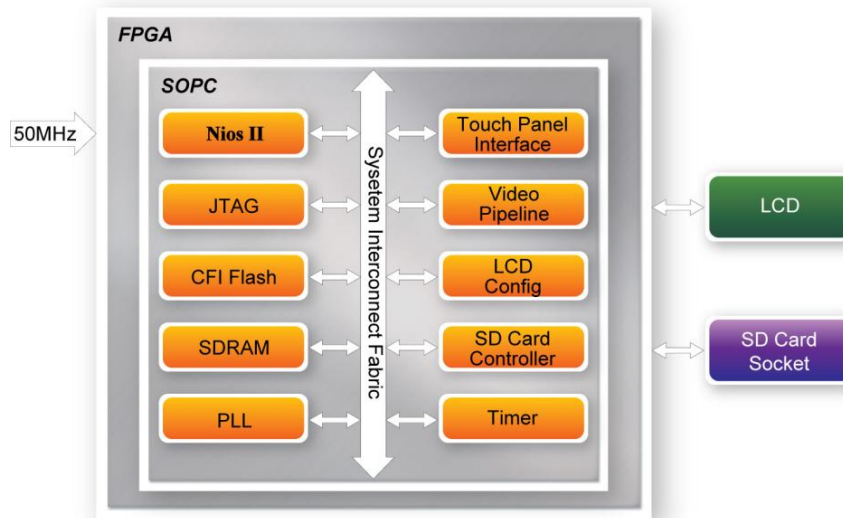

Figure 4-7 Block diagram of the picture viewer demonstration

## ■ Demonstration Source Code

- Project directory: tPad\_Picture\_Viewer
- Bit stream used: tPad\_Picture\_Viewer.sof
- Nios II Workspace: tPad\_Picture\_Viewer\Software

## ■ Demonstration Batch File

Demo Batch File Folder: tPad\_Picture\_Viewer\demo\_batch

The demo batch file includes the following files:

- Batch File: tPad\_Picture\_Viewer.bat, tPad\_Picture\_Viewer\_bashrc
- FPGA Configure File: tPad\_Picture\_Viewer.sof
- Nios II Program: tPad\_Picture\_Viewer.elf

## ■ Demonstration Setup

- Format your SD Card into FAT16 format
- Place the jpg image files to the \jpg subdirectory of the SD Card. For best display result, the image should have a resolution of 800x600 or the multiple of that
- Insert the SD Card to the SD Card slot on the tPad
- Load the bitstream into the FPGA on the tPad board



- Run the Nios II Software under the workspace tPad\_Picture\_Viewer\Software (Note\*)
- Touch the play button will proceed to display the next image. **Figure 4-8** gives a screen shot of the tPad picture viewer demonstration. **Table 4-1** shows the instructions for running the demonstration

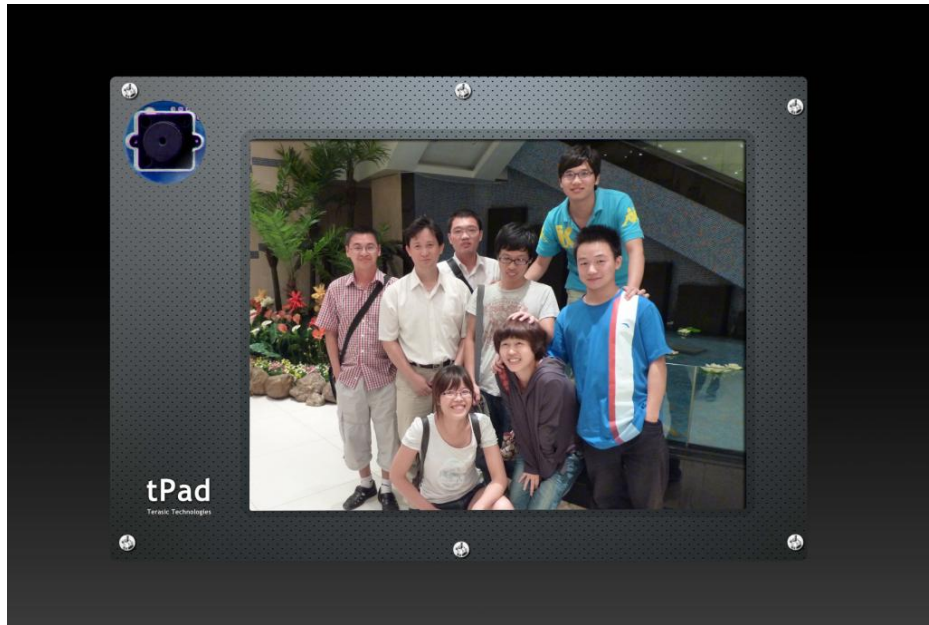

**Figure 4-8 tPad picture viewer demonstration**

**Table 4-1 Touch panel displayed information**

<i>Display information</i>	<i>Implication</i>
	Press the play button to display the next buffered image
<b>Loading...</b> 57.1%	Indicates the loading progress



*Note: execute the tPAD\_Picture\_Viewer.bat under tPAD\_Picture\_Viewer\demo\_batch will automatically download the .sof and .elf file.*

## 4.5 Video and Image Processing

The Video and Image Processing (VIP) Example Design demonstrates dynamic scaling and clipping of a standard definition video stream in either National Television System Committee (NTSC) or Phase Alternation Line (PAL) format and picture-in-picture mixing with a background layer. The video stream is output in high definition resolution (800×600) on the HSMC LTC daughter card (part of the tPad).

The example design demonstrates a framework for rapid development of video and image processing systems using the parameterizable MegaCore® functions that are available in the Video and Image Processing Suite. Available functions are listed in **Table 4-2**. This demonstration needs the Quartus II license file includes the VIP suite feature.

**Table 4-2 VIP IP cores functions**

<i>IP MegaCore Function</i>	<i>Description</i>
<b>Frame Reader</b>	<b>Reads video from external memory and outputs it as a stream.</b>
<b>Control Synchronizer</b>	<b>Synchronizes the changes made to the video stream in real time between two functions.</b>
<b>Switch</b>	<b>Allows video streams to be switched in real time.</b>
<b>Color Space Converter</b>	<b>Converts image data between a variety of different color spaces such as RGB to YCrCb.</b>
<b>Chroma Resampler</b>	<b>Changes the sampling rate of the chroma data for image frames, for example from 4:2:2 to 4:4:4 or 4:2:2 to 4:2:0.</b>
<b>2D FIR Filter</b>	<b>Implements a 3 x 3, 5 x 5, or 7 x 7 finite impulse response (FIR) filter on an image data stream to smooth or sharpen images.</b>
<b>Alpha Blending Mixer</b>	<b>Mixes and blends multiple image streams—useful for implementing text overlay and picture-in-picture mixing.</b>
<b>Scaler</b>	<b>A sophisticated polyphase scaler that allows custom scaling and real-time updates of both the image sizes and the scaling coefficients.</b>
<b>Deinterlacer</b>	<b>Converts interlaced video formats to progressive video format using a motion adaptive deinterlacing algorithm. Also supports 'bob' and "weave" algorithms</b>
<b>Test Pattern Generator</b>	<b>Generates a video stream that contains still color bars for use as a test pattern.</b>
<b>Clipper</b>	<b>Provides a way to clip video streams and can be configured at compile time or at run time.</b>
<b>Color Plane Sequencer</b>	<b>Changes how color plane samples are transmitted across the Avalon-ST interface. This function can be used to split and join video streams, giving control over the routing of color plane samples.</b>
<b>Frame Buffer</b>	<b>Buffers video frames into external RAM. This core supports double or triple-buffering with a range of options for frame dropping and repeating.</b>
<b>2D Median Filter</b>	<b>Provides a way to apply 3 x 3, 5 x 5, or 7 x 7 pixel median filters to video images.</b>
<b>Gamma Corrector</b>	<b>Allows video streams to be corrected for the physical properties of display devices.</b>
<b>Clocked Video Input/Output</b>	<b>These two cores convert the industry-standard clocked video format (BT-656) to Avalon-ST video and vice versa.</b>

These functions allow you to fully integrate common video functions with video interfaces, processors, and external memory controllers. The example design uses an Altera Cyclone® IV E EP4CE115F29 featured tPad board.

A video source is input through an analog composite port on tPad which generates a digital output in ITU BT656 format. A number of common video functions are performed on this input stream in the FPGA. These functions include clipping, chroma resampling, motion adaptive deinterlacing, color space conversion, picture-in-picture mixing, and polyphase scaling.

The input and output video interfaces on the tPad are configured and initialized by software running on a Nios® II processor. Nios II software demonstrates how to control the clocked video input, clocked video output, and mixer functions at run-time is also provided. The video system is implemented using the SOPC Builder system level design tool. This abstracted design tool provides an easy path to system integration of the video processing data path with a NTSC or PAL video input, VGA output, Nios II processor for configuration and control. The Video and Image Processing Suite MegaCore functions have common open Avalon-ST data interfaces and Avalon Memory-Mapped (Avalon-MM) control interfaces to facilitate connection of a chain of video functions and video system modeling. In addition, video data is transmitted between the Video and Image Processing Suite functions using the Avalon-ST Video protocol, which facilitates building run-time controllable systems and error recovery.

Figure 4-9 shows the Video and Image Processing block diagram.

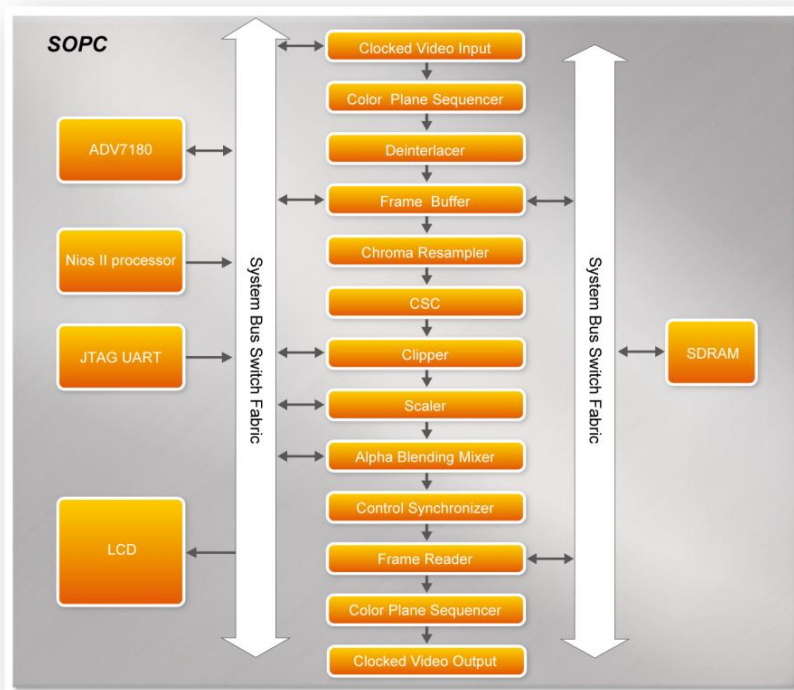

Figure 4-9 VIP Example SOPC Block Diagram (Key Components)

## ■ Demonstration Source Code

- Project directory: tPad\_VIP
- Bit stream used: tPad\_VIP.sof
- Nios II Workspace: tPad\_VIP\Software

## ■ Demonstration Batch File

Demo Batch File Folder: tPad\_VIP\demo\_batch

The demo batch file includes the following files:

- Batch File: tPad\_VIP.bat, tPad\_VIP\_bashrc
- FPGA Configure File: tPad\_VIP.sof
- Nios II Program: tPad\_VIP.elf

## ■ Demonstration Setup

- Connect a DVD player's composite video output(yellow plug) to the Video-IN RCA jack(J12) of the tPad board. The DVD player has to be configured to provide NTSC output or PAL output
- Connect the VGA output of the tPad board to a VGA monitor (both LCD and CRT type of monitors should work)
- Load the bit stream into FPGA (note\*)
- Run the Nios II and choose tPad\_VIP\Software as the workspace. Click on the Run button (note \*)
- Press and drag the video frame box will result in scaling the playing window to any size, as shown in **Figure 4-10**



**Note:**

*(1).Execute tPad\_VIP\demo\_batch\tPad\_VIP.bat will download .sof and .elf files.*

*(2).You may need additional Altera VIP suite Megacore license features to recompile the project.*

**Figure 4-11** illustrates the setup for this demonstration.



Figure 4-10 The VIP demonstration running result

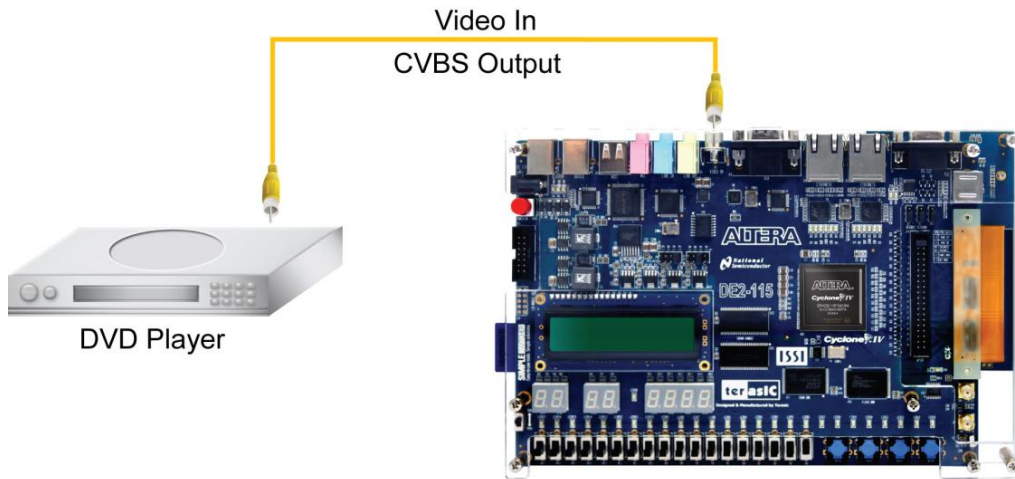

Figure 4-11 Setup for the tPad\_VIP demonstration

## 4.6 tPad Camera Application

This demonstration shows a digital camera reference design using the 5-Megapixel CMOS sensor and 8-inch LCD modules on the tPad. The CMOS sensor module sends the raw image data to FPGA on DE2-115 Board, the FPGA on the board is handling image processing part and converts the data to RGB format to display on the LCD module. The I2C Sensor Configuration module is used to configure the CMOS sensor module. **Figure 4-12** shows the block diagram of the demonstration.

As soon as the configuration code is downloaded into the FPGA, the I2C Sensor Configuration block will initial the CMOS sensor via I2C interface. The CMOS sensor is configured as follow:

- Row and Column Size: 800 \* 600
- Exposure time: Adjustable
- Pix clock:  $MCLK * 2 = 25 * 2 = 50MHz$
- Readout modes: Binning
- Mirror mode: Line mirrored

According to the settings, we can calculate the CMOS sensor output frame rate is about 44.4 **fps**.

After the configuration, The CMOS sensor starts to capture and output image data streams, the CMOS sensor Capture block extracts the valid pix data streams based on the synchronous signals from the CMOS sensor. The data streams are generated in Bayer Color Pattern format. So it's then converted to RGB data streams by the RAW2RGB block.

After that, the Multi-Port SDRAM Controller acquires and writes the RGB data streams to the SDRAM which performs as a frame buffer. The Multi-Port SDRAM Controller has two write ports and read ports also with 16-bit data width each. The writing clock is the same as CMOS sensor pix clock, and the reading clock is provided by the LCD Controller, which is 40MHz.

Finally, the LCD controller fetches the RGB data from the buffer and displays it on the LCD panel continuously. Because the resolution and timing of the LCD is compatible with SVGA@800\*600, the LCD controller generates the same timing and the frame rate can achieve about 25 **fps**.

For the objective of a better visual effect, the CMOS sensor is configured to enable the left right mirror mode. User could disable this functionality by modifying the related register value being written to CMOS controller chip.

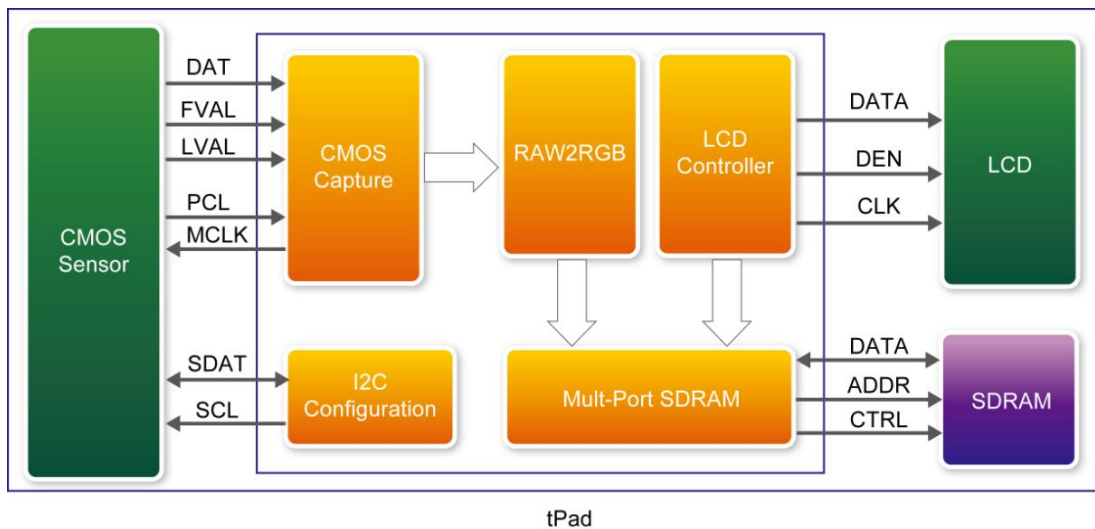

**Figure 4-12 Block diagram of the digital camera design**

## ■ Demonstration Source Code

- Project directory: tPad\_Camera
- Bit stream used: tPad\_Camera.sof

## ■ Demonstration Batch File

Demo Batch File Folder: tPad\_Camera\demo\_batch

The demo batch file includes the following files:

- Batch File: tPad\_Camera.bat
- FPGA Configure File: tPad\_Camera.sof

## ■ Demonstration Setup

- Load the bit stream into FPGA by execute the batch file 'tPad\_Camera.bat' under tPad\_Camera\demo\_batch\ folder
- The system enters the **FREE RUN** mode automatically. Press **KEY[0]** on the DE2-115 board to reset the circuit
- Press **KEY[2]** to take a shot of the photo; you can press **KEY[3]** again to switch back to **FREE RUN** mode and you should be able to see whatever the camera captures on the LCD display
- User can use the **SW[0]** and **KEY[1]** to set the exposure time for brightness adjustment of the image captured. When **SW[0]** is set to Off, the brightness of image will be increased as **KEY[1]** is pressed longer. If **SW[0]** is set to On, the brightness of image will be decreased as **KEY[1]** is pressed shorter
- User can use **SW[17]** to mirror image of the line. However, remember to press **KEY[0]** after toggle **SW[17]**



*Note: execute the tPad\_Camera.bat under tPad\_Camera\demo\_batch will automatically download the .sof file.*

**Table 4-3** summarizes the functional keys of the digital camera. **Figure 4-13** gives a run-time

photograph of the demonstration.

**Table 4-3 The functional keys of the digital camera demonstration**

<i>Component</i>	<i>Function Description</i>
KEY[0]	Reset circuit
KEY[1]	Set the new exposure time (use with SW[0] )
KEY[2]	Trigger the Image Capture (take a shot)
KEY[3]	Switch to Free Run mode
SW[0]	Off: Extend the exposure time
	On: Shorten the exposure time
HEX[7:0]	Frame counter (Display ONLY)



**Figure 4-13 Screen shot of the tPad camera demonstration**

## 4.7 Video and Image Processing for Camera

The Video and Image Processing (VIP) for Camera Example Design demonstrates dynamic scaling and clipping of a standard definition video stream in RGB format and picture-in-picture mixing with a background layer. The video stream is output in high definition resolution (800×600) on the HSMC LTC daughter card (part of the tPad).

The example design demonstrates a framework for rapid development of video and image processing systems using the parameterizable MegaCore® functions that are available in the Video and Image Processing Suite. Available functions are listed in Table 4 2. This demonstration needs the Quartus II license file includes the VIP suite feature.



These functions allow you to fully integrate common video functions with video interfaces, processors, and external memory controllers. The example design uses an Altera Cyclone® IV E EP4CE115F29 featured tPad board.

A video source is input through the CMOS sensor on tPad which generates a digital output in RGB format. A number of common video functions are performed on this input stream in the FPGA. These functions include clipping, chroma resampling, motion adaptive deinterlacing, color space conversion, picture-in-picture mixing, and polyphase scaling.

The input and output video interfaces on the tPad are configured and initialized by software running on a Nios® II processor. Nios II software demonstrates how to control the clocked video input, clocked video output, and mixer functions at run-time is also provided. The video system is implemented using the SOPC Builder system level design tool. This abstracted design tool provides an easy path to system integration of the video processing data path with a NTSC or PAL video input, VGA output, Nios II processor for configuration and control. The Video and Image Processing Suite MegaCore functions have common open Avalon-ST data interfaces and Avalon Memory-Mapped (Avalon-MM) control interfaces to facilitate connection of a chain of video functions and video system modeling. In addition, video data is transmitted between the Video and Image Processing Suite functions using the Avalon-ST Video protocol, which facilitates building run-time controllable systems and error recovery.

For the objective of a better visual effect, the CMOS sensor is configured to enable the left right mirror mode. User could disable this functionality by modifying the related register value being written to CMOS controller chip.

**Figure 4-14** shows the Video and Image Processing block diagram.

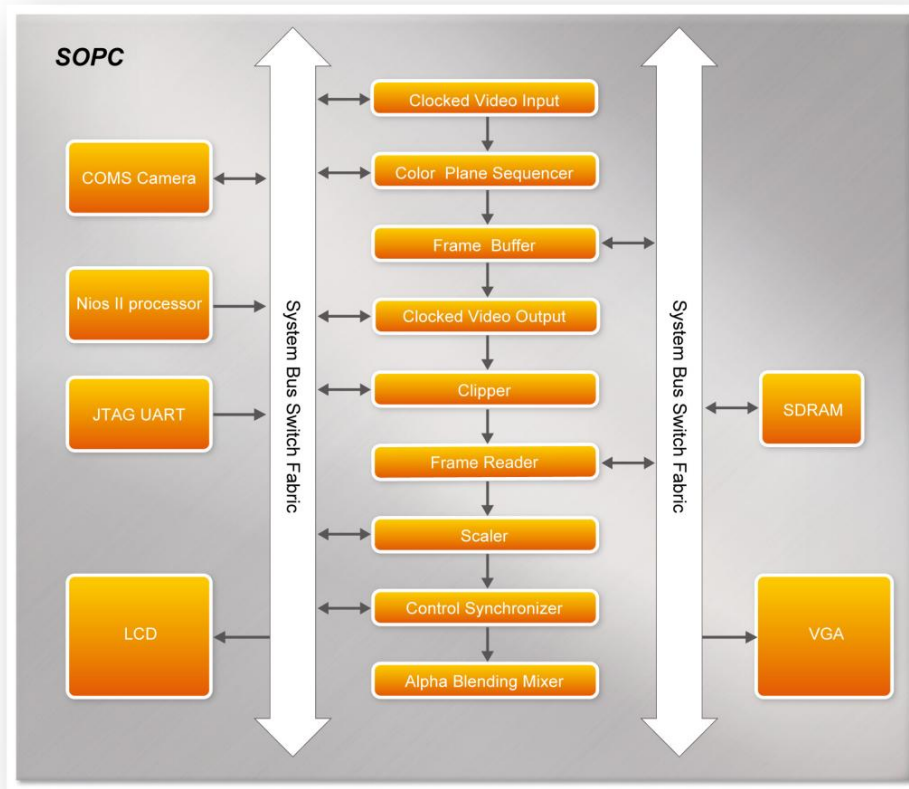

Figure 4-14 VIP Camera Example SOPC Block Diagram (Key Components)

### ■ Demonstration Source Code

- Project directory: tPad\_VIP\_Camera
- Bit stream used: tPad\_VIP\_Camera.sof
- Nios II Workspace: tPad\_VIP\_Camera \Software

### ■ Demonstration Batch File

Demo Batch File Folder: tPad\_VIP\_Camera\demo\_batch

The demo batch file includes the following files:

- Batch File: tPad\_VIP\_Camera.bat, tPad\_VIP\_Camera \_bashrc
- FPGA Configure File: tPad\_VIP\_Camera.sof
- Nios II Program: tPad\_VIP\_Camera.elf

## ■ Demonstration Setup

- Connect the VGA output of the tPad board to a VGA monitor (both LCD and CRT type of monitors should work)
- Load the bit stream into FPGA (note\*)
- Run the Nios II and choose tPad\_VIP\_Camera\Software as the workspace. Click on the Run button (note \*)
- The system enters the **FREE RUN** mode automatically. Press **KEY[0]** on the DE2-115 board to reset the circuit
- Press **KEY[2]** to stop run; you can press **KEY[3]** again to switch back to **FREE RUN** mode and you should be able to see whatever the camera captures on the VGA display
- User can use SW[17] to mirror image of the line. However, remember to press KEY[0] after toggle SW[17]
- Press and drag the video frame box will result in scaling the playing window to any size, as shown in **Figure 4-10**



### *Note:*

*(1).Execute tPad\_VIP\_Camera\demo\_batch\tPad\_VIP\_CameraA.bat will download .sof and .elf files.*

*(2).You may need additional Altera VIP suite Megacore license features to recompile the project.*

**Figure 4-15** illustrates the setup for this demonstration.

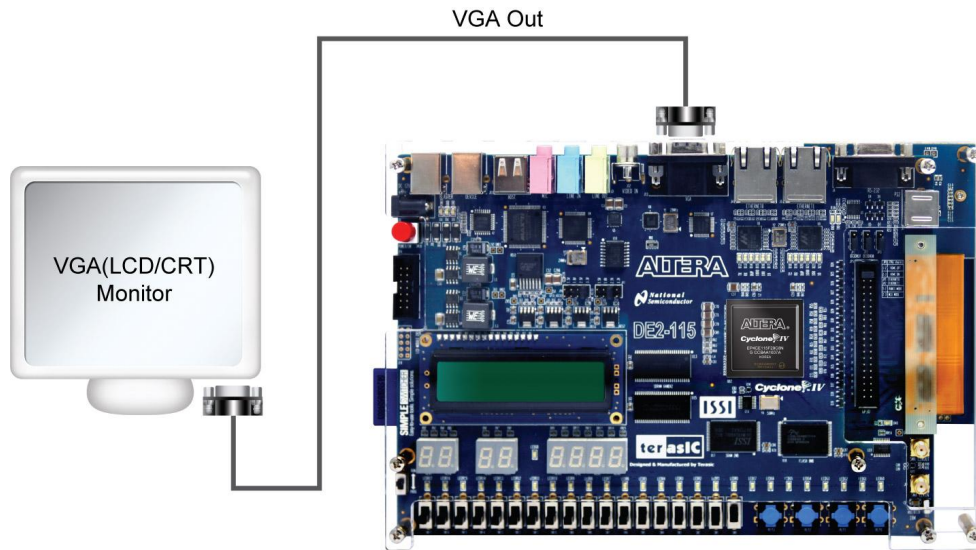

Figure 4-15 Setup for the tPad\_VIP\_Camera demonstration

## 4.8 tPad Digital Accelerometer Demonstration

This demonstration shows a bubble level implementation based on a digital accelerometer. We use I<sup>2</sup>C protocol to control the ADXL345 digital accelerometer, and the LCD display the interface of our game. When tilt the tPad board, the ADXL345 measures the static acceleration of gravity. In our Nios II software, we compute the change of angle in the x-axis and y-axis, and show angle data in the LCD display.

Figure 4-16 shows the hardware system block diagram of this demonstration. The system is clocked by an external 50MHz Oscillator. Through the internal PLL module, the generated 150MHz clock is used for Nios II processor and other components, and there also a 40MHz pixel clock for the video pipeline and 10MHz for low-speed peripherals.

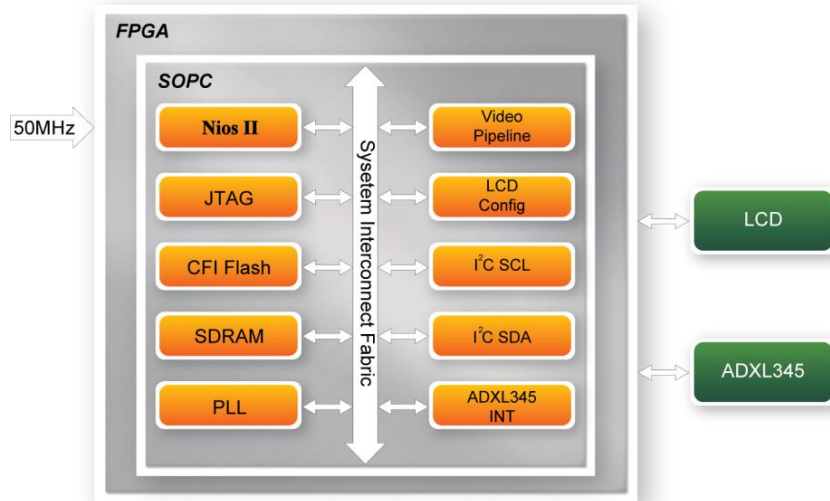

Figure 4-16 Block diagram of the digital accelerometer demonstration

### ■ Demonstration Source Code

- Project directory: tPad\_G\_sensor
- Bit stream used: G\_sensor.sof
- Nios II Workspace: tPad\_G\_sensor\Software

### ■ Demonstration Batch File

Demo Batch File Folder: tPad\_G\_sensor\demo\_batch

The demo batch file includes the following files:

- Batch File: G\_sensor.bat, G\_sensor \_bashrc
- FPGA Configure File: G\_sensor.sof
- Nios II Program: G\_sensor.elf

### ■ Demonstration Setup

- Load the bitstream into the FPGA on the tPad board
- Run the Nios II Software under the workspace tPad\_G\_sensor\Software (Note\*).
- After Nios II program is downloaded and executed successfully, a prompt message will be displayed in nios2-terminal, the message is “its ADXL345’s ID = e5”.
- Tilt the tPad board to the all directions, you will find that the degree will change in the LCD

display. **Figure 4-17** shows the result for running the demonstration

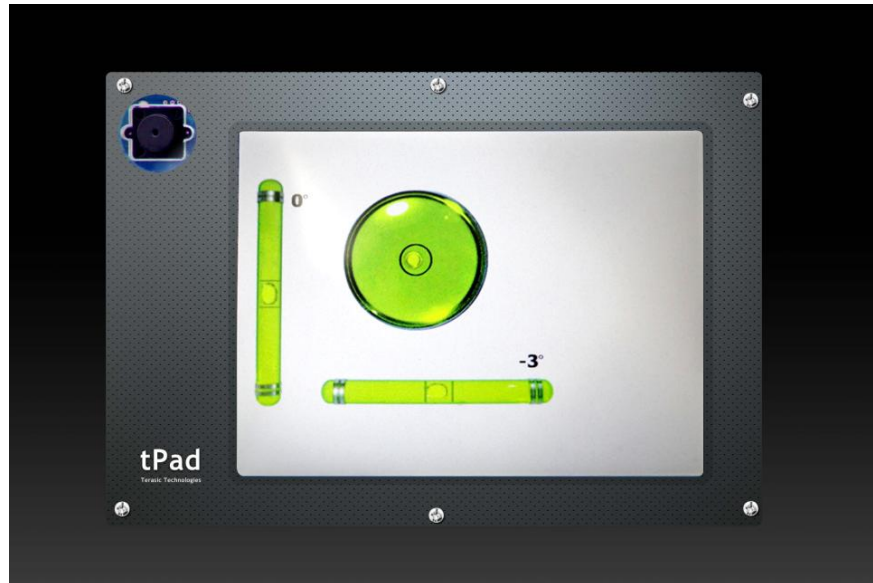

**Figure 4-17 tPad Digital Accelerometer demonstration**



**Note:**

*Execute `tPad_G_sensor \demo_batch\G_sensor.bat` will download `.sof` and `.elf` files.*

## Chapter 5

# *Application Selector*

The application selector utility is the default code that powers on the FPGA and offers a graphical interface on LCD allowing users to select and run different demonstrations resides on SD Card.

### 5.1 Ready to Run SD Card Demos

You can find several Ready to Run SD Card demos in your SD Card root directory as well as in the System CD under **tPad\_Factory\_Recovery\Application\_Selector** folder. **Figure 5-1** shows the photograph of the application selector main interface.



**Figure 5-1 Application selector main interface**

Also, you can easily convert your own applications to be loadable by the application selector. For more information see “**Creating Your Own Loadable Applications**” in section 5.3. If you have lost the contained files in the SD Card, you could find them on the tPad System CD under the **tPad\_Factory\_Recovery** folder.

## 5.2 Running the Application Selector

- Connect power to the tPad board
- Insert the SD Card with applications into the SD Card socket of tPad
- Switch on the power (SW18) (1\*)
- Scroll to select the demonstration to load using the side-bar
- Tap on the **Load** button to load and run a demonstration (2\*)



### Note:

- (1). If the board is already powered, the application selector will boot from EPCS, and a splash screen will appear while the application selector searches for applications on the SD Card.*
- (2). The application will begin loading, and a window will be displayed showing the progress. Loading will take between 2 and 30 seconds, depending on the size of the application.*

## 5.3 Application Selector Details

This section describes some details about the operation of the application selector utility.

### SD Card

The Application Selector uses the SD Card for storing applications. The SD Card must be formatted with the FAT 16 file system, and can be any capacity up to 2GB. Long file names are supported. The Nios II CPU access the SD Card through an SD Card SPI controller.

### Application Files

Each loadable application consists of two binary files, all stored on the SD Card. The first binary file represents the software portion of the example and must be derived from an .ELF file as described in the section of this document titled “Creating Your Own Loadable Applications”. This binary file can be named anything supported by the FAT16 file system, the only restriction being that the name must end with **\_SW.bin**. The second binary file represents the hardware portion of the example and must be derived from a .SOF file as described in the section of this document titled “Creating Your Own Loadable Applications”. This file can be named anything supported by the FAT 16 file system, the only restriction being that the name must end with **\_HW.bin**.

### SD Card Directory Structure

All loadable applications on the SD Card must be located in a top-level directory named **Application\_Selector**. Under the **Application\_Selector** directory, each application is located in its own subdirectory. The name of that subdirectory is important because the application selector utility uses that name as the title of the application when displaying it in the main menu. The subdirectory



names can be anything so long as they adhere to the FAT file system long file name rules. Spaces are permitted.

## CFI Flash

CFI flash is used to store the software binary files of applications. All software binary files used by the application selector contain a boot copier which is pre-ended by the Nios2-elf-objcopy utility during file conversion process described in the “Creating Your Own Loadable Applications” section. The boot copier copies the software code to program memory before running it. The Application software binary file is stored in flash at load time to an offset 0x0.

## EPCS Device

EPCS is used to store both the binary file of the Application Selector (both hardware and software image) itself, as well as hardware binary files of applications which are being loaded. The Application Selector binary file is permanently stored in EPCS device at offset 0x0. Hardware binary files for the applications being loaded get written to EPCS at load time to an offset 0x400000.

## Creating Your Own Loadable Applications

It is easy to convert your own Nios II design into an application which is loadable by the Application Selector utility. All you need is a hardware image (a .SOF file) and a software image which runs on that hardware (a Nios II .ELF file).

The only restrictions are:

- The hardware designs must contain a CFI Flash controller (1\*)
- If the .SOF file contains a Nios II CPU, then its reset address should be set to CFI Flash at offset 0x0
- Before compiling the software, make sure you have set your software’s program memory (.text section) in Flash memory under the System Library Properties (Nios II IDE) page or through BSP Editor (Nios II SBT for Eclipse) utility (2\*)

Once you have your working .SOF and .ELF file pair, perform the following steps to convert them to a loadable application selector compatible application.

- Copy both the .SOF and .ELF files into a common directory relying on your choice. This directory is where you will convert the files
- On your host PC, launch a Nios II Command Shell from **Start ->Programs -> Altera -> Nios II <version #> EDS -> Nios II Command Shell**
- From the command shell navigate to where your SOF file is located and create your hardware binary file using the following commands
- Convert .sof file into .flash file

```
sof2flash --eps --input="your example.sof" --output="your example_HW.flash"(3*)
```

- Convert .flash file into .binary file

```
nios2-elf-objcopy -I srec -O binary "your example_HW.flash" "your example_HW.bin"
```

- From the command shell navigate to where your ELF file is located and create your software binary file using the following command

```
nios2-elf-objcopy -O binary "your example.elf" "your example_SW.bin"(4,5*)
```

- Create a new subdirectory and name it what you would like the title of your application to be shown as in the application selector
- Using an SD Card reader, copy the directory onto an SD Card into a directory named "Application\_Selector". The directory structure on the SD Card should look like this:

```
Application_Selector\<<Name of Application>\{\<elf_name>_SW.bin;\<sof_name>_HW.bin}
```

- Place the SD Card in the tPad board, and switch on the power. The Application Selector will start up, and you will now see your application appear as one of the selections



**Note:**

(1). You may not need a CFI Flash controller when your design does not contain a Nios II processor or you store your software code within the on-chip memory and use the .hex initialization file.

(2). If you would like to use other memories such as SRAM or SDRAM as the program memory, you may need to perform two steps to convert your .elf file into .bin file to make the software properly run on tPad. The commands seem to look like this:

```
elf2flash --base=flash_base_address --end=flash_end_address --reset=flash_base_address
--input="<your software name>.elf" --output="<your software name>.flash"
--boot="$SOPC_KIT_NIOS2/components/altera_nios2/boot_loader_cfi.srec"
```

```
nios2-elf-objcopy -I srec -O binary <your software name>.flash <your software name>_SW.bin
```

(3). You may pad a --compress option for saving binary image space because the Cyclone IV E series support the decompress feature while loading hardware image from EPCS device.

(4). The command will use the default HAL boot loader and link it to the .text section.

(5). You can also use the tool 'bin\_demo\_batch' to convert your sof and elf to bin. Copy "your example.sof" and "your example.elf" to the bin\_demo\_batch folder, rename them to test.sof, test.elf, execute the test.bat, then the final test\_HW.bin and test\_SW.bin are your target files.

## 5.4 Restoring the Factory Image

This section describes some details about the operation of restoring the Application Selector factory image.

### Combining factory recovery binary files

In the factory settings, you need to program Application Selector binary files to EPCS. Before programming, you should combine application selector software binary file and hardware binary file together by executing the instructions below:

- Copy both the tPad\_Selector.sof and tPad\_Selector.elf files into a common directory relying on your choice. This directory is where you will convert the files
- On your host PC, launch a Nios II Command Shell from **Start ->Programs -> Altera -> Nios II <version #> EDS -> Nios II Command Shell**
- From the command shell navigate to where your SOF file is located and create your hardware binary file using the following command commands listed below
- Convert tPad\_Selector.sof file into tPad\_Selector\_HW.flash file

```
sof2flash --epcs --input=tPad_Selector.sof --output= tPad_Selector_HW.flash
```

- Convert .flash file into .bin file

```
nios2-elf-objcopy -I srec -O binary tPad_Selector_HW.flash tPad_Selector_HW.bin
```

- From the command shell navigate to where your ELF file is located and create your software bin image using the following command commands listed below
- Convert tPad\_Selector.elf into tPad\_Selector\_SW.flash

```
elf2flash --epcs --after=tPad_Selector_HW.flash --input=tPad_Selector.elf  
--output=tPad_Selector_SW.flash
```

- Convert tPad\_Selector\_SW.flash into tPad\_Selector\_SW.bin

```
nios2-elf-objcopy -I srec -O binary tPad_Selector_SW.flash tPad_Selector_SW.bin
```

- Combine tPad\_Selector\_HW.bin and tPad\_Selector\_SW.bin using the following command

```
cat tPad_Selector_HW.bin tPad_Selector_SW.bin > tPad_Selector.bin
```

- The generated tPad\_Selector.bin is our target binary file

## Restoring the original binary file

To restore the original contents of the Application Selector, perform the following steps:

- Copy tPad\_Selector project into a local directory of your choice. The tPad\_Selector project is placed in **tPad\_Demonstrations\tPad\_Selector**
- Power on the tPad board, with the USB cable connected to the USB Blaster port
- Download the tPad\_Selector.sof to the board by using either JTAG or AS programming
- Run the Nios II and choose **tPad\_Selector\Software** as the workspace
- Choose **Tools > Flash Programmer** to open the flash programmer
- Choose Program a file into memory, choose your tPad\_Selector.bin file. See **Figure 5-2**
- Click Program Flash to start program tPad\_Selector.bin to EPCS in the board
- When program finish, power on again



*Note: You can also use 'tPad\_Selector\_batch' to generate selector.bin and restore the original binary file by executing the tPad\_Selector.bat under the tPad\_Factory\_Recovery\tPad\_Selector\_batch folder.*

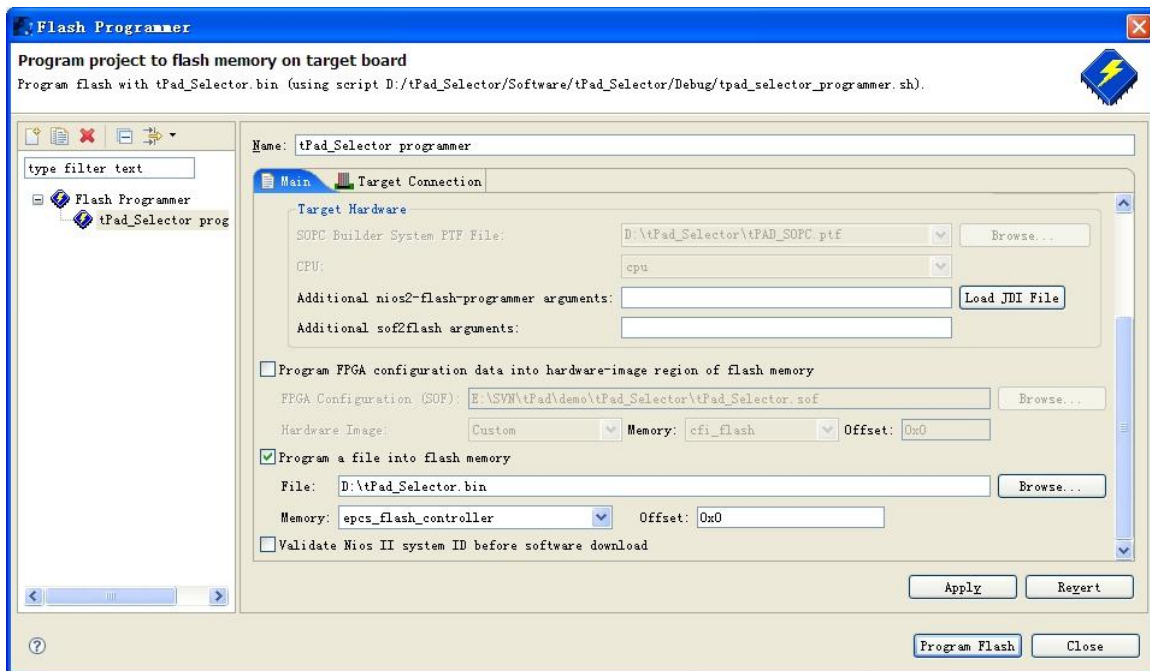

Figure 5-2 Programming Flash settings

## Chapter 6

# Appendix

---

### 6.1 Revision History

<i>Version</i>	<i>Change Log</i>
V1.0	Initial Version (Preliminary)
V1.0.1	Kit content image updated
V1.0.2	Descriptions of the camera demonstration's mirror mode added
V1.0.3	Descriptions of the G sensor module added

### 6.2 Copyright Statement

Copyright © 2010 Terasic Technologies. All rights reserved.