

# 10/100Base-T Single Port LAN Transformer

## Extended Temperature

**APT-106**

**RoHS/RoHS II Compliant**



12.70 x 9.40 x 5.70mm

### FEATURES:

- Meet IEEE802.3 specification
- Extended Temperature (-40°C - +85°C)
- ROHS peak reflow temperature rating 245°C
- 1500Vrms Hi-Pot

### APPLICATIONS:

- Designed for most leading PHY IC manufacturers such as Broadcom, Marvell, Micrel, & Microsemi
- 10/100Base-T Ethernet-LAN
- VoIP
- Symmetrical Tx & RX channels for Auto MDI/MDIX capability
- Provides signal conditioning, EMI suppression and signal isolation.
- Hubs/Switches/Routers/Servers/NIC Cards

### STANDARD SPECIFICATIONS:

Parameters	Minimum	Typical	Maximum	Units	Notes
Operating Temperature	-40		+85	°C	
Storage Temperature	-40		+85	°C	
Inductance	350			μH	100KHz/0.1V@ 8mA
Leakage Inductance			0.4	μH	100KHz/0.1V
Cw/w			25	pF	100KHz/0.1V
DC Resistance			1.5	Ω	
Insertion Loss			-1.1	dB	0.3-100MHz
Return Loss		-20		dB	30MHz
		-14			60MHz
		-11.5			80MHz
Cross Talk	-45			dB	30MHz
	-40				60MHz
	-27				100MHz
Differential to Common Mode Rejection	-42			dB	30MHz
	-37				50MHz
	-33				100MHz
Common Mode Rejection	-30			dB	1-100MHz
Turns Ratio (± 2%)	1CT: 1CT				
Hi-Pot	1500Vrms/0.5mA/60Sec or 1650Vrms/0.5mA/2Sec				

### OUTLINE DRAWING:

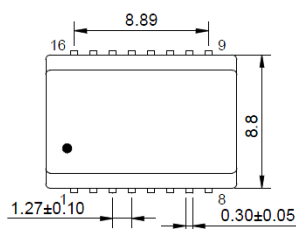

#### Recommended Land Pattern

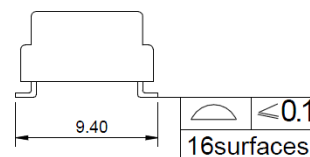
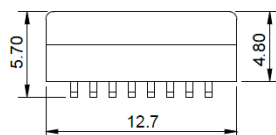
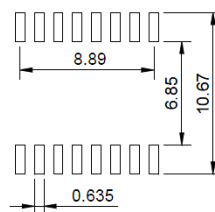

**Dimensions: mm (Unless otherwise specified, tolerances are ±0.25)**

ABRACON IS  
ISO9001:2008  
CERTIFIED

**ABRACON**<sup>®</sup>  
The Power of Linking Together

2 Faraday, Suite# B | Irvine | CA 92618 **Revised: 03.24.15**  
Ph. 949.546.8000 | Fax. 949.546.8001  
Visit [www.abracon.com](http://www.abracon.com) for Terms and Conditions of Sale



# 10/100Base-T Single Port LAN Transformer

## Extended Temperature



12.70 x 9.40 x 5.70mm

APT-106

RoHS/RoHS II Compliant

### TAPE & REEL:

**Packing Option I:** 700 pcs / reel  
**Weight:** 0.7 grams / pcs

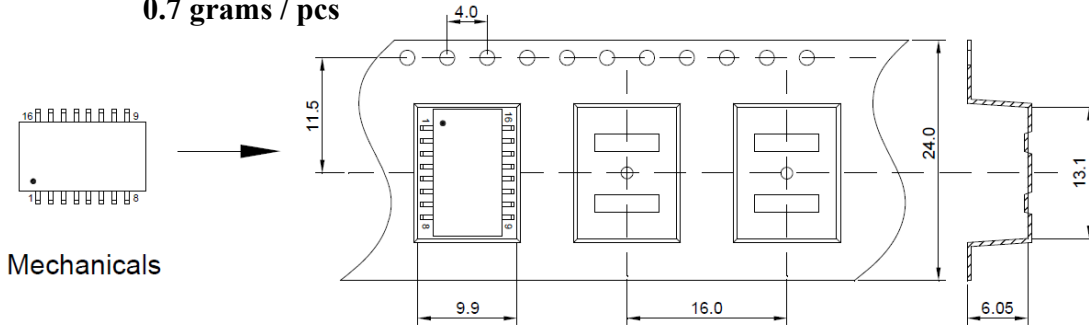

Tape & Reel

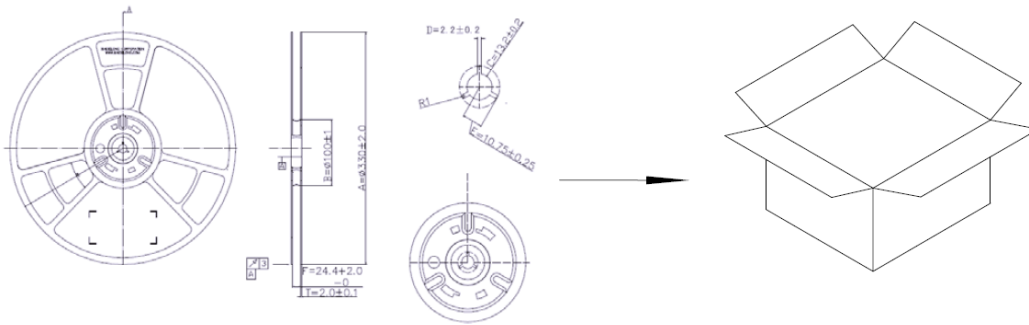

**Packing Option II:** 36 pcs / tube  
**Weight:** 0.7 grams / pcs

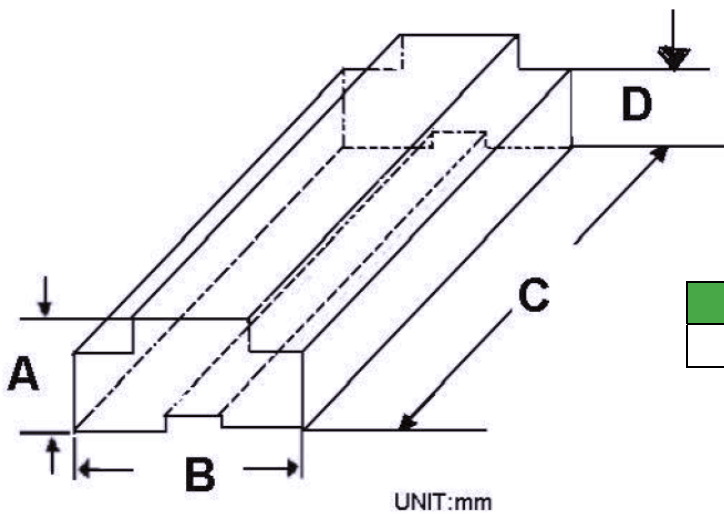

A	B	C	D
9.20	13.70	485.0	6.0

UNIT:mm

Dimensions: mm

**ATTENTION:** Abracon Corporation's products are COTS – Commercial-Off-The-Shelf products; suitable for Commercial, Industrial and, where designated, Automotive Applications. Abracon's products are not specifically designed for Military, Aviation, Aerospace, Life-dependant Medical applications or any application requiring high reliability where component failure could result in loss of life and/or property. For applications requiring high reliability and/or presenting an extreme operating environment, written consent and authorization from Abracon Corporation is required. Please contact Abracon Corporation for more information.

ABRACON IS  
 ISO9001:2008  
 CERTIFIED



2 Faraday, Suite# B | Irvine | CA 92618 Revised: 03.24.15  
 Ph. 949.546.8000 | Fax. 949.546.8001  
 Visit [www.abracon.com](http://www.abracon.com) for Terms and Conditions of Sale

# Mouser Electronics

Authorized Distributor

Click to View Pricing, Inventory, Delivery & Lifecycle Information:

[ABRACON:](#)

[APT-106](#) [APT-106-T](#)