

MAX2674/MAX2676

GPS/GNSS LNAs with Antenna Switch and Bias

General Description

The MAX2674/MAX2676 are ultra-small, high-IP3, low-noise amplifiers (LNAs) designed for GPS L1, Galileo, and GLONASS applications. Designed in Maxim's advanced SiGe process, the devices are also equipped with an autosensing feature for applications that enable the use of external antennas. These high-performance LNAs provide high gain and an ultra-low noise figure while optimizing the input-referred 2dB compression point and 3rd-order intercept point.

The ultra-small size is ideal for front-end modules and receiver applications in cellular phones, smartphones, PDAs, PNDs, or other custom GNSS applications. The MAX2674/MAX2676 operate from a 1.6V to 3.6V single supply. The MAX2674 is optimized for high gain, while the MAX2676 is optimized for high linearity. A shutdown feature is present in both devices reducing the supply current to less than 10 μ A. The antenna port automatically senses when an external antenna is connected, eliminating the need for additional control circuitry while also providing improved short-circuit protection. The MAX2674/MAX2676 are available in an ultra-small, RoHS-compliant 0.86mm x 1.26mm x 0.64mm wafer-level package (WLP).

Features

- ◆ **Eliminate Discrete Antenna Sensing, Switching, and Bias Networks**
 - Autodetect Antenna Connection
 - Provide Antenna Bias
 - Short-Circuit Protection
- ◆ **Wide 1.6V to 3.6V Supply Voltage Range**
- ◆ **Ultra-Small Footprint (0.86mm x 1.26mm) WLP Package**
- ◆ **For Applications Without Antenna Port, Use Pin-Compatible 4-Bump MAX2686/MAX2687/MAX2688 LNA**

Applications

Front-End SAW Modules
 Receiver Modules
 Cellular and Smartphones
 Telematics (Asset Tracking and Management)
 Personal Navigation Devices (PNDs)
 Recreational, Marine Navigation

Ordering Information

PART	TEMP RANGE	PIN-PACKAGE
MAX2674EWT+T	-40°C to +85°C	6 WLP
MAX2676EWT+T	-40°C to +85°C	6 WLP

+ Denotes a lead(Pb)-free/RoHS-compliant package.
 T = Tape and reel.

Typical Operating Circuit

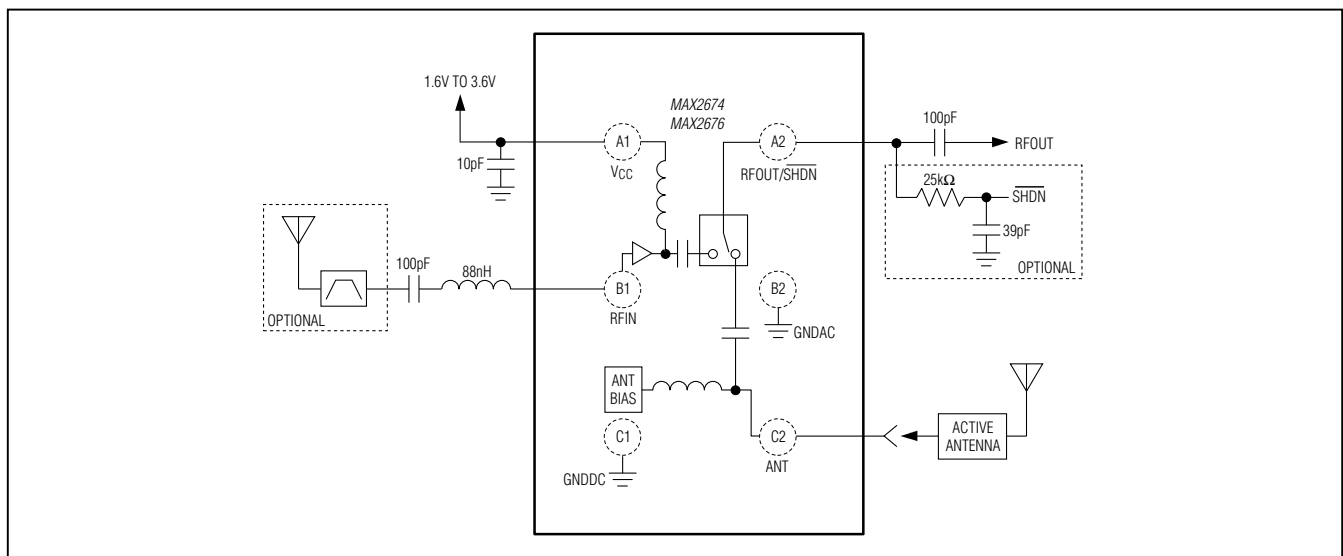

For pricing, delivery, and ordering information, please contact Maxim Direct at 1-888-629-4642, or visit Maxim's website at www.maximintegrated.com.

MAX2674/MAX2676

GPS/GNSS LNAs with Antenna Switch and Bias

ABSOLUTE MAXIMUM RATINGS

V _{CC} to GND_	-0.3V to +3.9V	Operating Temperature Range	-40°C to +85°C
Other Pins to GND_	-0.3V to (V _{CC} + 0.3V)	Junction Temperature	+150°C
Maximum Input Power	+5dBm	Storage Temperature Range	-65°C to +160°C
Continuous Power Dissipation (T _A = +70°C)		Soldering Temperature (reflow, Note 1)	+260°C
WLP (derate 10.5mW/°C above +70°C)	840mW		

Note 1: Refer to Application Note 1891: *Wafer-Level Packaging (WLP) and its Applications*.



CAUTION! ESD SENSITIVE DEVICE

Stresses beyond those listed under "Absolute Maximum Ratings" may cause permanent damage to the device. These are stress ratings only, and functional operation of the device at these or any other conditions beyond those indicated in the operational sections of the specifications is not implied. Exposure to absolute maximum rating conditions for extended periods may affect device reliability.

DC ELECTRICAL CHARACTERISTICS

(V_{CC} = 1.6V to 3.6V, no RF signal applied, T_A = -40°C to +85°C. Typical values are at V_{CC} = 3.3V, T_A = +25°C, unless otherwise noted.) (Note 2)

PARAMETER	CONDITIONS	MIN	TYP	MAX	UNITS
Supply Voltage		1.6	3.3	3.6	V
Supply Current			4.5	7	mA
Shutdown Current	V _{SHDN} = 0V			10	μA
Shutdown Logic-Low				0.45	V
Shutdown Logic-High		1.2			V
ANT Sense Threshold	Causes autosense to switch to ANT	75	200	850	μA
ANT Current Limit	ANT connected to GND_	20	30	45	mA
ANT Port Supply Drop	Voltage drop from V _{CC} with 10mA load on ANT		75		mV

AC ELECTRICAL CHARACTERISTICS

(V_{CC} = 1.6V to 3.6V, f_{RFIN} = 1575.42MHz, T_A = -40°C to +85°C. Typical values are at V_{CC} = 3.3V, T_A = +25°C, unless otherwise noted.) (Note 2)

PARAMETER	CONDITIONS	MIN	TYP	MAX	UNITS
Minimum RF Input Frequency			1575.42		MHz
Maximum RF Input Frequency			1610		MHz
Power Gain	MAX2674	13	18		dB
	MAX2676	11	15		
Noise Figure			0.75		dB
In-Band Input IP3	MAX2674, RF input = f ₀ ±2.5MHz at -40dBm each		-2		dBm
	MAX2676, RF input = f ₀ ±2.5MHz at -40dBm each		+5		
ANT In-Band Input IP3	RF input = f ₀ ±2.5MHz at -25dBm each		+30		dBm

MAX2674/MAX2676

GPS/GNSS LNAs with Antenna Switch and Bias

AC ELECTRICAL CHARACTERISTICS (continued)

(VCC = 1.6V to 3.6V, f_{RFIN} = 1575.42MHz, T_A = -40°C to +85°C. Typical values are at VCC = 3.3V, T_A = +25°C, unless otherwise noted.) (Note 2)

PARAMETER	CONDITIONS	MIN	TYP	MAX	UNITS
Out-of-Band Input IP3	MAX2674, RF input = 1713.42MHz, -17dBm and 1851.42MHz, -59dBm		3		dBm
	MAX2676, RF input = 1713.42MHz, -17dBm and 1851.42MHz, -59dBm		5		
Input P2dB	MAX2674, f _{RFIN} = 1580.42MHz		-7		dBm
	MAX2676, f _{RFIN} = 1580.42MHz		-4		
Input Return Loss			15		dB
Output Return Loss			15		dB
Reverse Isolation			45		dB
ANT Insertion Loss			1.5		dB
RFIN to ANT Isolation			45		dB

Note 2: Guaranteed by test at T_A = +25°C, guaranteed by design and characterization at T_A = -40°C and T_A = +85°C.

Typical Operating Characteristics

(MAX2674/MAX2676 EV Kit. Typical values are at VCC = 3.3V, T_A = +25°C, unless otherwise specified.)

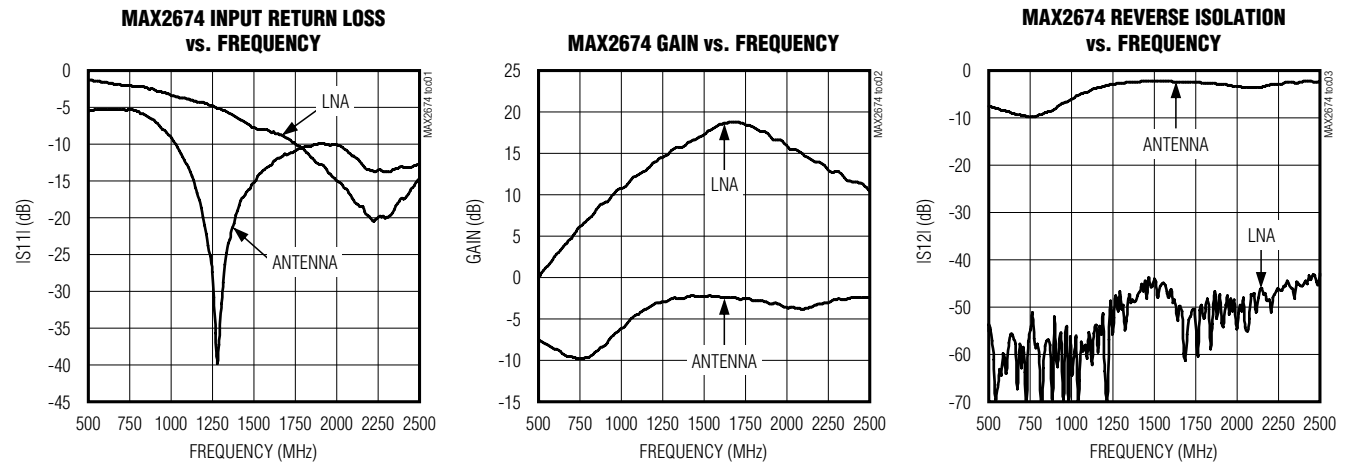

MAX2674/MAX2676

GPS/GNSS LNAs with Antenna Switch and Bias

Typical Operating Characteristics (continued)

(MAX2674/MAX2676 EV Kit. Typical values are at $V_{CC} = 3.3V$, $T_A = +25^\circ C$, unless otherwise specified.)

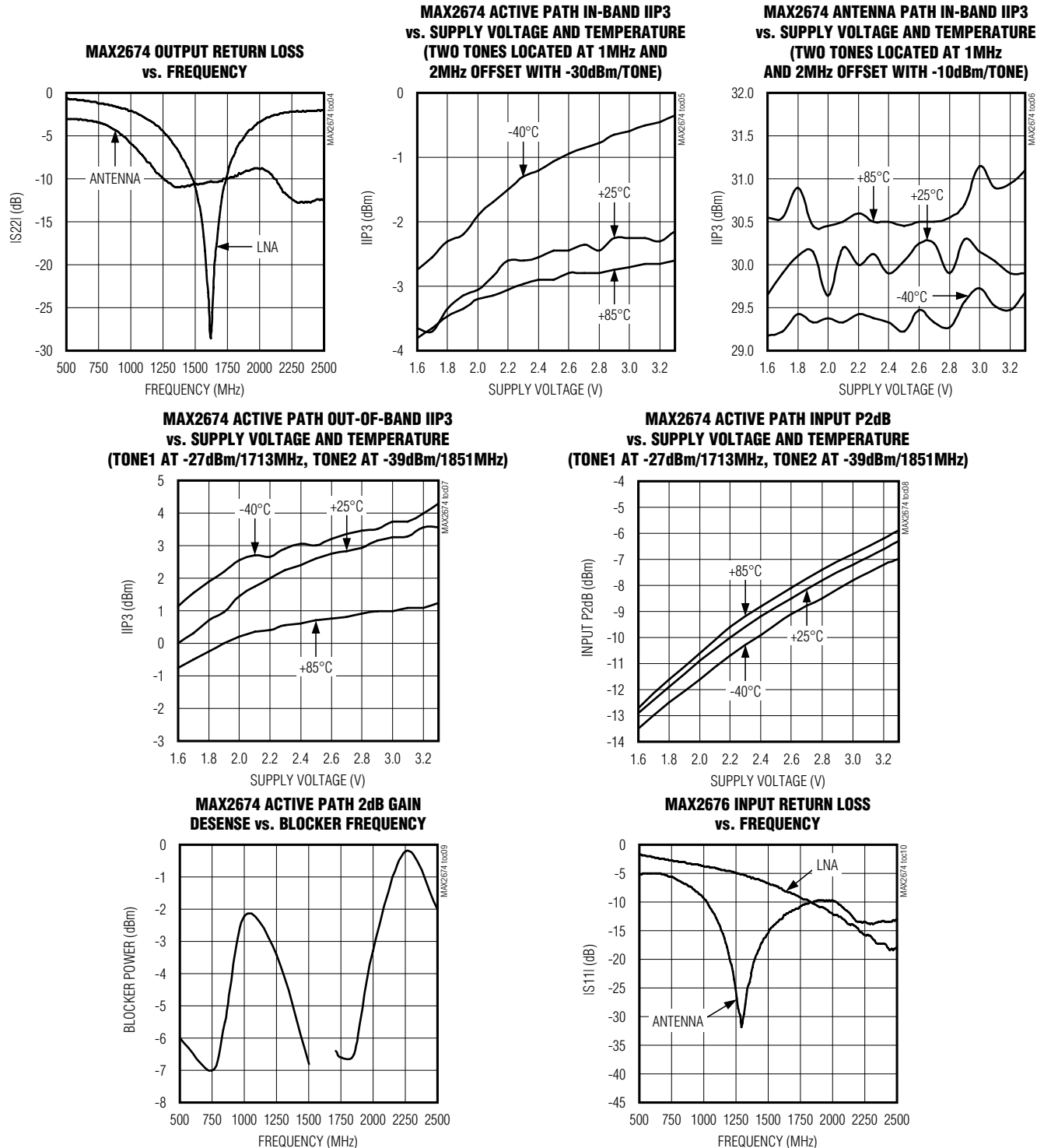

MAX2674/MAX2676

GPS/GNSS LNAs with Antenna Switch and Bias

Typical Operating Characteristics (continued)

(MAX2674/MAX2676 EV Kit. Typical values are at $V_{CC} = 3.3V$, $T_A = +25^\circ C$, unless otherwise specified.)

MAX2676 GAIN vs. FREQUENCY

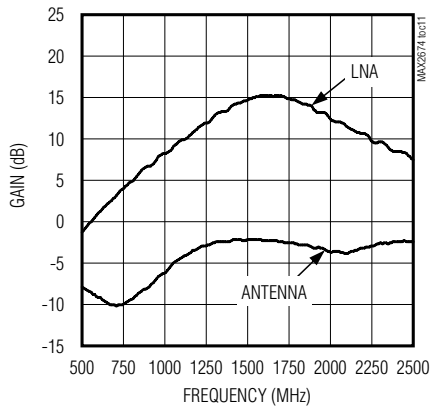

MAX2676 REVERSE ISOLATION vs. FREQUENCY

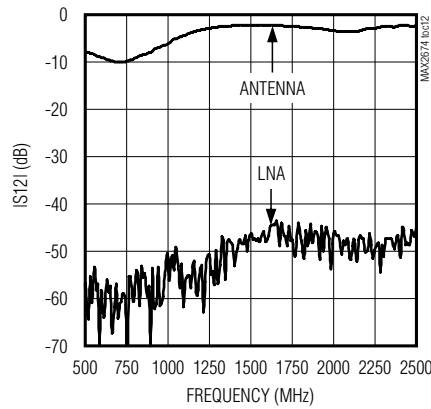

MAX2676 OUTPUT RETURN LOSS vs. FREQUENCY

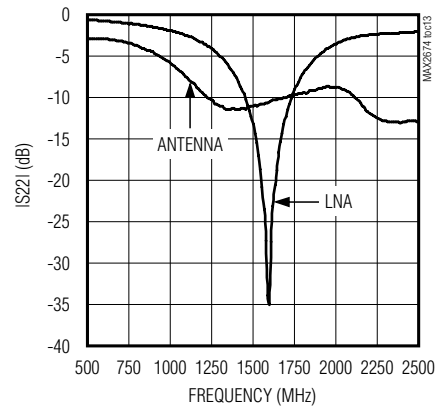

MAX2676 ACTIVE PATH IN-BAND IIP3 vs. SUPPLY VOLTAGE AND TEMPERATURE (TWO TONES LOCATED AT 1MHz AND 2MHz OFFSET WITH -30dBm/TONE)

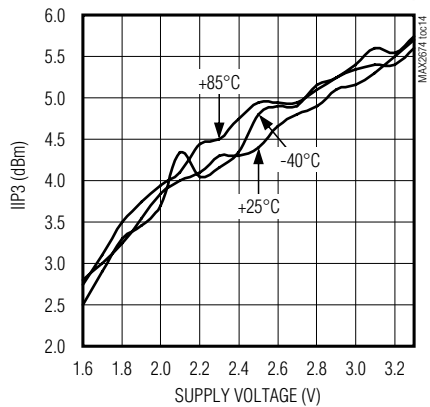

MAX2676 ANTENNA PATH IN-BAND IIP3 vs. SUPPLY VOLTAGE AND TEMPERATURE (TWO TONES LOCATED AT 1MHz AND 2MHz OFFSET WITH -10dBm/TONE)

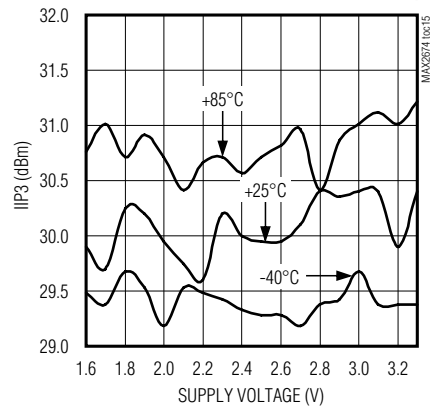

MAX2676 ACTIVE PATH OUT-OF-BAND IIP3 vs. SUPPLY VOLTAGE AND TEMPERATURE (TONE1 AT -27dBm/1713MHz, TONE2 AT -39dBm/1851MHz)

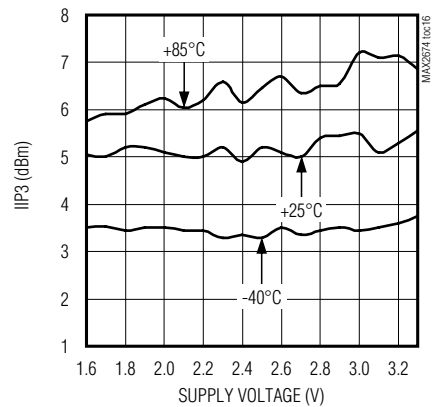

MAX2676 ACTIVE PATH INPUT P2dB vs. SUPPLY VOLTAGE AND TEMPERATURE (TONE1 AT -27dBm/1713MHz, TONE2 AT -39dBm/1851MHz)

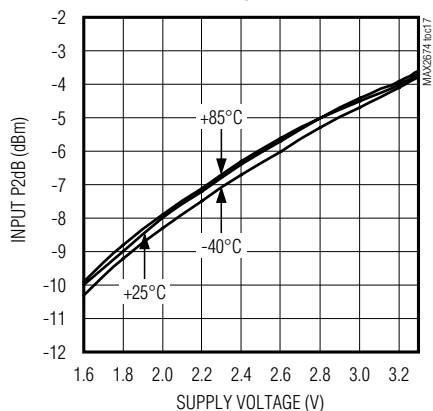

MAX2676 ACTIVE PATH 2dB GAIN DESENSE vs. BLOCKER FREQUENCY

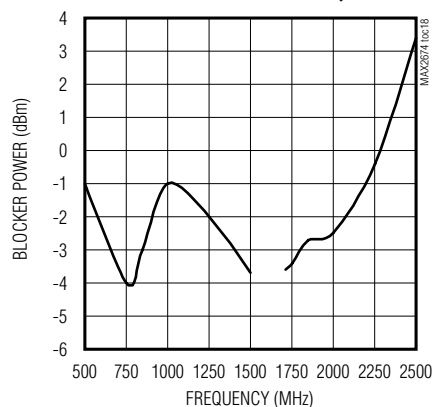

MAX2674/MAX2676

GPS/GNSS LNAs with Antenna Switch and Bias

Bump Configuration

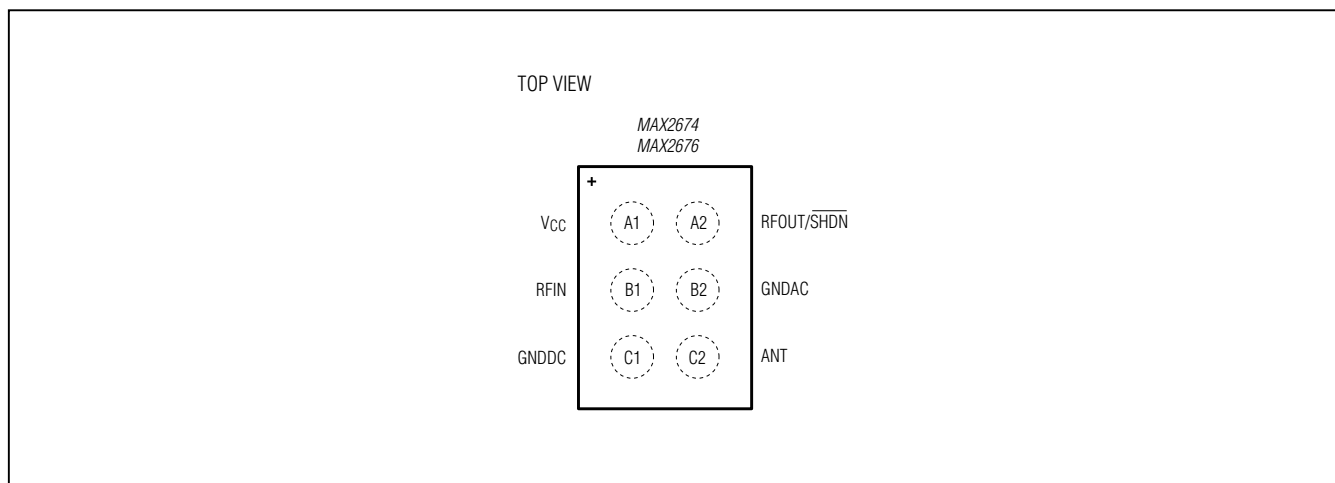

Bump Description

PIN	NAME	FUNCTION
A1	VCC	VCC. Place bypass capacitor as close as possible to the pin.
A2	RFOUT/ SHDN	RF Output and Shutdown Logic Input. Output match is included on-chip. Couple $\overline{\text{SHDN}}$ logic control through a 25k Ω resistor. DC logic-low shuts down the part.
B1	RFIN	RF Input. Requires a DC-blocking capacitor and an external inductor matching component.
B2	GNDAC	Ground for RF Circuits. Connect to the 2nd layer PCB ground plane with a via next to the pad.
C1	GNDDC	Ground for DC and Bias Circuits. Connect to the 2nd layer PCB ground plane with a via next to the pad.
C2	ANT	Antenna Input

MAX2674/MAX2676

GPS/GNSS LNAs with Antenna Switch and Bias

Detailed Description

The MAX2674/MAX2676 are low-power LNAs designed for GPS/GNSS receiver applications. The devices feature low noise and high linearity in an ultra-small package. They also include an antenna switch and circuitry supporting bias to accommodate external LNA applications.

Input and Output Matching

To achieve optimal performance in noise figure, gain, and IIP3, the devices require one matching inductor at RFIN in series with a DC-blocking capacitor. RFOUT/SHDN is internally matched to 50Ω, eliminating the need for external matching components. At RFOUT/SHDN, an external DC-blocking capacitor should be used to isolate the shutdown control function.

Shutdown Mode

To place the device in shutdown mode, apply logic-low to RFOUT/SHDN through a 25kΩ resistor. An additional DC-blocking capacitor or component is required at RFOUT/SHDN in this case. Apply a logic-high state or no DC bias to turn the part permanently on.

DC Supply Decoupling and Layout

A properly designed PC board (PCB) is essential to any RF microwave circuit. Use controlled-impedance lines on all high-frequency inputs and outputs. Bypass VCC with a decoupling capacitor located close to the device.

For long VCC lines, it may be necessary to add additional decoupling capacitors. Locate these additional capacitors further away from the device package.

Proper grounding of GND_ pins is essential. If the PCB uses a top-side RF ground, connect it directly to the GND_ pins. For a board where the ground is not on the component layer, connect the GND_ pins to the board with multiple vias close to the package.

Antenna Switch Control

The MAX2674/MAX2676 ANT input includes an autodection feature. When no current is drawn from ANT, the switch defaults to normal LNA operation. The pin can be directly connected to an external active antenna. The device automatically switches to the ANT input when an external active antenna is connected.

Refer to www.maximintegrated.com for the MAX2674/MAX2676 EV Kit schematic, layout files, BOM information, and S-parameters.

Table 1. MAX2674 Typical Noise Parameters (VCC = 2.85V, TA = +25°C)

FREQUENCY (MHz)	NFMIN (dB)	GAMMA_OPT MAG (°)	GAMMA_OPT PHASE (°)	Rn (Ω)
1550	0.651	0.446	44.1	8.33
1560	0.652	0.445	44.3	8.33
1570	0.654	0.445	44.6	8.32
1580	0.655	0.444	44.8	8.31
1590	0.656	0.444	45.1	8.3
1600	0.657	0.443	45.4	8.3

Table 2. MAX2676 Typical Noise Parameters (VCC = 2.85V, TA = +25°C)

FREQUENCY (MHz)	NFMIN (dB)	GAMMA_OPT MAG (°)	GAMMA_OPT PHASE (°)	Rn (Ω)
1550	0.744	0.441	53.1	8.7
1560	0.746	0.44	53.4	8.68
1570	0.748	0.439	53.7	8.66
1580	0.75	0.438	54	8.65
1590	0.751	0.437	54.3	8.63
1600	0.753	0.436	54.7	8.62

MAX2674/MAX2676

GPS/GNSS LNAs with Antenna Switch and Bias

Chip Information

PROCESS: SiGe BiCMOS

Package Information

For the latest package outline information and land patterns, go to www.maximintegrated.com/packages. Note that a "+", "#", or "-" in the package code indicates RoHS status only. Package drawings may show a different suffix character, but the drawing pertains to the package regardless of RoHS status.

PACKAGE TYPE	PACKAGE CODE	OUTLINE NO.	LAND PATTERN NO.
6 WLP	W61B1+1	21-0217	Refer to Application Note 1891

MAX2674/MAX2676

GPS/GNSS LNAs with Antenna Switch and Bias

Revision History

REVISION NUMBER	REVISION DATE	DESCRIPTION	PAGES CHANGED
0	12/10	Initial release	—
1	7/15	Removed Avionics and Military from <i>Applications</i>	1



Maxim Integrated cannot assume responsibility for use of any circuitry other than circuitry entirely embodied in a Maxim Integrated product. No circuit patent licenses are implied. Maxim Integrated reserves the right to change the circuitry and specifications without notice at any time. The parametric values (min and max limits) shown in the Electrical Characteristics table are guaranteed. Other parametric values quoted in this data sheet are provided for guidance.

Maxim Integrated 160 Rio Robles, San Jose, CA 95134 USA 1-408-601-1000

9