

## ACPDQC5V0-HF

### High-Reliability and High-Performance

### RoHS Device

### Halogen Free



#### Features

- Bi-directional ESD protection.
- IEC61000-4-2 Level 4 ESD protection.
- Ultra small SMD package:0402.
- Surface mount package.
- High component density.
- AEC-Q101 Qualified.

#### Mechanical data

- Case: 0402C/SOD-923F standard package, molded plastic.
- Terminals: Gold plated, solderable per MIL-STD-750, method 2026.
- Mounting position: Any.
- Weight: 0.001 grams (approx.).

#### Circuit Diagram

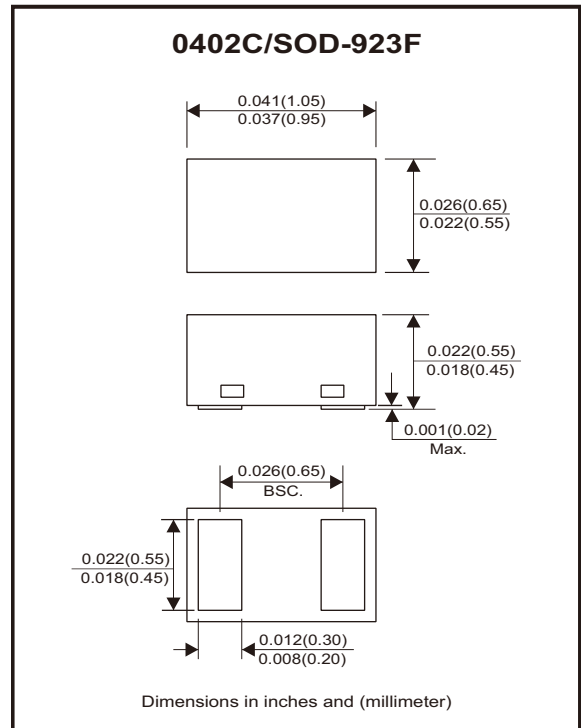

#### Maximum Rating (at TA=25°C unless otherwise noted)

Parameter	Conditions	Symbol	Value	Unit
Peak pulse power	$T_P = 8/20\mu s$	$P_{PP}$	75	W
Peak pulse current	$T_P = 8/20\mu s$	$I_{PP}$	5	A
ESD capability	IEC 61000-4-2(air)	ESD	$\pm 15$	kV
	IEC 61000-4-2(contact)	ESD	$\pm 8$	
Operating temperature range		$T_j$	-40~+125	°C
Storage temperature range		$T_{STG}$	-55~+150	°C

#### Electrical Characteristics (at TA=25°C unless otherwise noted)

Parameter	Conditions	Symbol	Min	Typ	Max	Unit
Working peak reverse voltage		$V_{RWM}$			5	V
Breakdown voltage	$I_T = 1mA$	$V_{BR}$	5.1	7		V
Reverse leakage current	$V_{RWM} = 5V$	$I_R$		0.1	2	$\mu A$
Clamping voltage	$I_{PP} = 1A, T_P = 8/20\mu s$	$V_C$			10	V
	$I_{PP} = 5A, T_P = 8/20\mu s$	$V_C$			15	V
Junction capacitance	$V_R = 0V, f = 1MHz$	$C_J$		15	20	pF

## RATING AND CHARACTERISTIC CURVES (ACPDQC5V0-HF)

Fig.1 - 8/20 $\mu$ s Peak Pulse Current Waveform Acc. IEC 61000-4-5

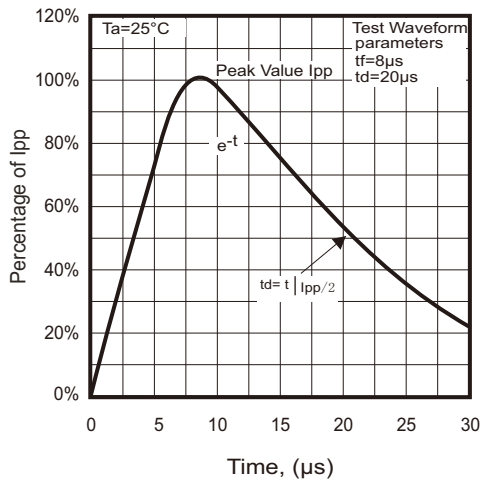

Fig.2 - Power Rating Derating Curve

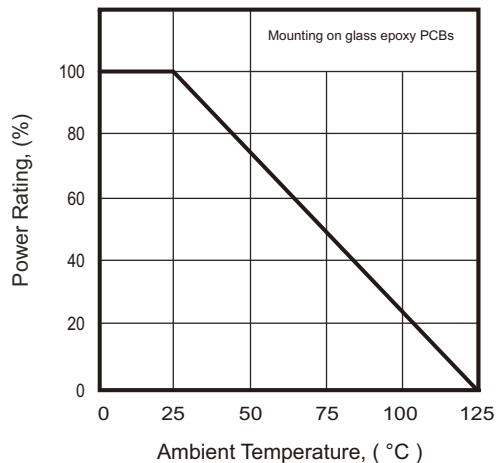

Fig.3 - Clamping Voltage Vs. Peak Pulse Current

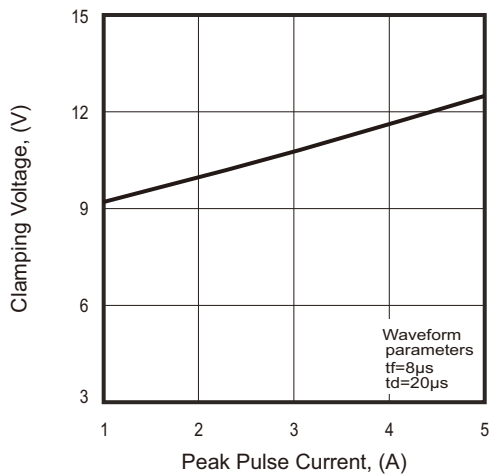
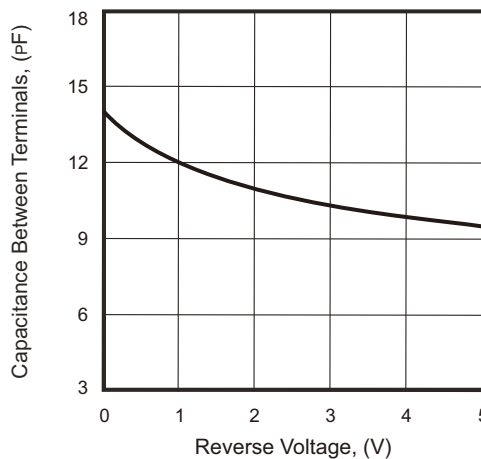
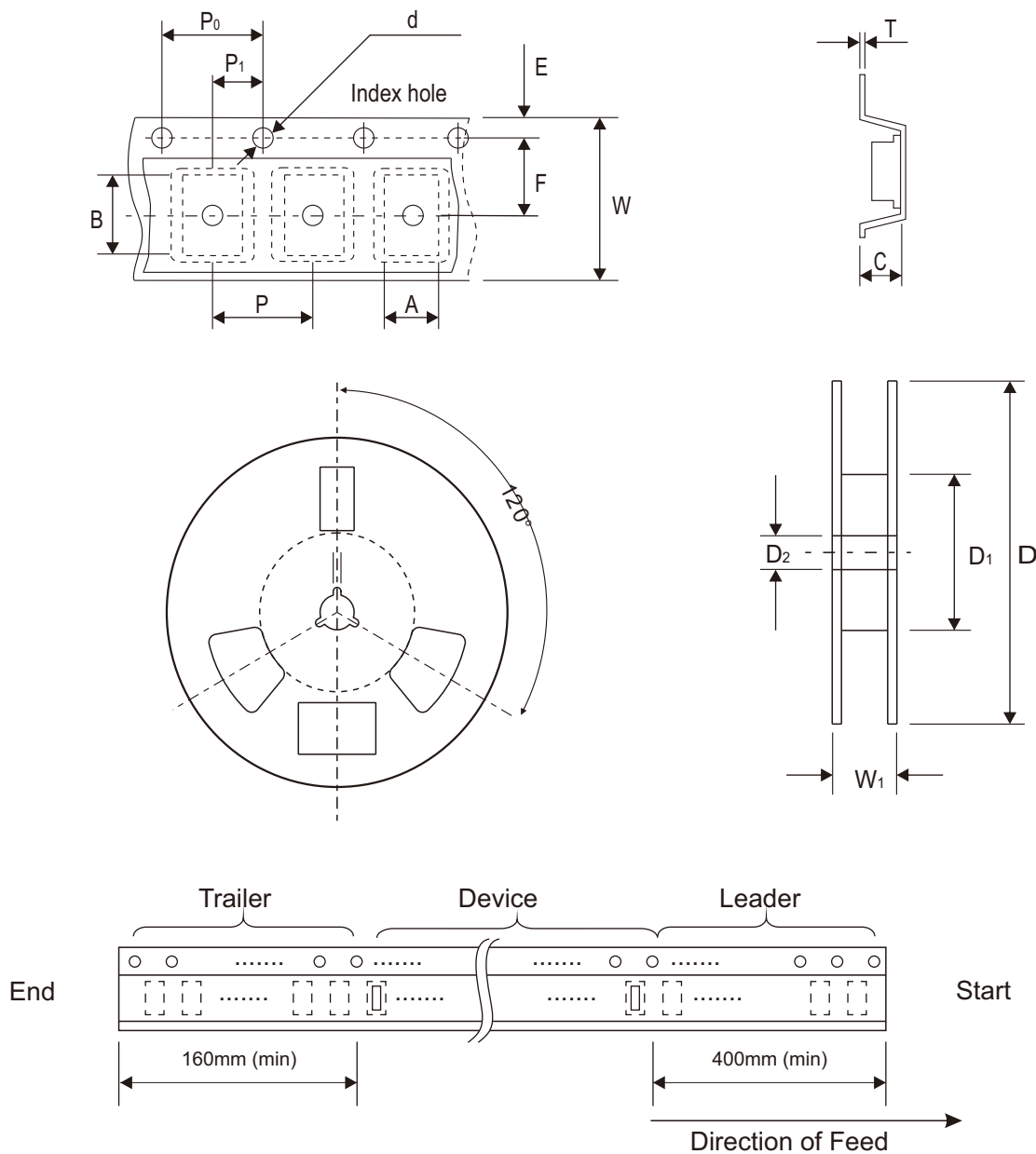

Fig.4 - Capacitance Between Terminals Characteristics



## Reel Taping Specification



0402C (SOD-923F)	SYMBOL	A	B	C	d	D	D <sub>1</sub>	D <sub>2</sub>
	(mm)	0.75 ± 0.05	1.17 ± 0.05	0.65 ± 0.05	1.50 + 0.10 - 0	178.00 ± 1.00	60.00 ± 0.50	13.50 ± 0.20
	(inch)	0.030 ± 0.002	0.046 ± 0.002	0.026 ± 0.002	0.059 + 0.004 - 0	7.008 ± 0.039	2.362 ± 0.020	0.531 ± 0.008

0402C (SOD-923F)	SYMBOL	E	F	P	P <sub>0</sub>	P <sub>1</sub>	T	W	W <sub>1</sub>
	(mm)	1.75 ± 0.10	3.50 ± 0.10	4.00 ± 0.10	4.00 ± 0.10	2.00 ± 0.10	0.20 + 0.02 - 0.05	8.00 ± 0.20	12.00 + 0.50 - 0
	(inch)	0.069 ± 0.004	0.138 ± 0.004	0.157 ± 0.004	0.157 ± 0.004	0.079 ± 0.004	0.008 + 0.001 - 0.002	0.315 ± 0.008	0.472 + 0.020 - 0

## Marking Code

Part Number	Marking Code
ACPDQC5V0-HF	E5



xx = Product type marking code

## Suggested PAD Layout

SIZE	0402C/SOD-923F	
	(mm)	(inch)
A	0.70	0.028
B	0.40	0.016
C	0.60	0.024
D	1.10	0.043
E	0.30	0.012

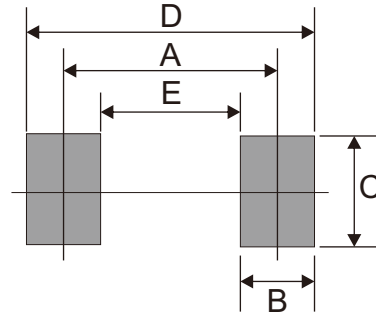

## Standard Packaging

Case Type	REEL PACK	
	REEL ( pcs )	Reel Size (inch)
0402C/SOD-923F	5,000	7