

59085

Vane Sensor



Description

The 59085 is a reed vane sensor with integral actuator magnet. It's actuation occurs when a suitable low carbon steel vane passes through the slot between the magnet and switch. It is normally open, normally closed, high voltage normally closed or changeover contacts. It is capable of switching up to 265Vac/300Vdc at 10VA. It is ideally suited to position and limit sensing, security, linear actuator, industrial process control and shaft rotation applications.

Features

- Sensor and magnet contained in single housing
- Sensor operates when ferrous vane passes through slot
- Choice of cable length and connector
- RoHS Compliant

Benefits

- Hermetically sealed, magnetically operated contacts continue to operate long after optical and other technologies fail due to contamination
- Quick and reliable single screw mounting with location feature
- No standby power requirement

Agency Approvals

| Agency | Agency File Number |
|--------|--------------------|
| | E61760 |

Note: Contact Littelfuse for specific agency approval ratings.

Applications

- Position and limit sensing
- Security system switch
- Linear actuators
- Industrial process control
- Shaft rotation sensing

Dimensions

Dimensions in mm (inch)

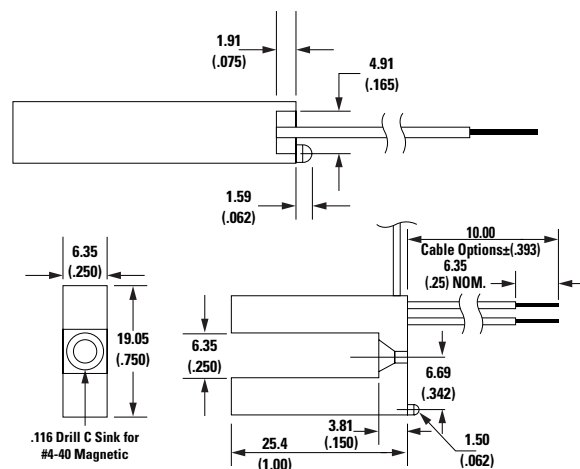

59085

Vane Sensor

Electrical Ratings

| | Contact Type | | Normally Open | Change Over | Normally Closed | Normally Closed H.V. |
|-----------------------------|-----------------------------|----------------|-----------------|-----------------|------------------|----------------------|
| Switch Type | - | - | 1 | 3 | 4 | 5 |
| Contact Rating ¹ | - | VA/Watt - max. | 5 | 5 | 10 | 10 |
| Voltage ⁴ | Switching ² | Vdc - max. | 175 | 175 | 200 | 300 |
| | Breakdown ³ | Vac - max. | 120 | 120 | 140 | 265 |
| Current ⁴ | Switching ² | Vdc - min. | 200 | 200 | 250 | 400 |
| | | Carry | Aac - max. | 0.25 | 0.25 | 0.5 |
| | | | Aac - max. | 0.18 | 0.18 | 0.35 |
| Resistance ⁵ | Contact, Initial Insulation | Aac - max. | 1.5 | 1.5 | 1.2 | 1.4 |
| | | Ω - max. | 0.2 | 0.2 | 0.2 | 0.2 |
| | | Ω - min. | 10 ⁹ | 10 ⁹ | 10 ¹⁰ | 10 ¹⁰ |
| Capacitance | Contact | pF - typ. | 0.3 | 0.3 | 0.3 | 0.2 |
| Temperature | Operating | °C | -40 to +105 | -40 to +105 | -40 to +105 | -20 to +105 |

Product Characteristics



| | | | | | | |
|---------------------------|-------------|-----------|-----|-----|-----|-----|
| Operate Time ⁶ | - | ms - max. | 3.0 | 3.0 | 1.0 | 1.0 |
| Release Time ⁶ | - | ms - max. | 3.0 | 3.0 | 1.0 | 1.0 |
| Shock ⁷ | 11ms ½ sine | G - max. | 50 | 50 | 100 | 100 |
| Vibration ⁷ | 50-2000 Hz | G - max. | 30 | 30 | 30 | 30 |

Notes:

- Contact rating - Product of the switching voltage and current should never exceed the wattage rating. Contact Littelfuse for additional load/life information.
- When switching inductive and/or capacitive loads, the effects of transient voltages and/or currents should be considered. Refer to Application Notes AN108A and AN107 for details.
- Breakdown Voltage - per MIL-STD-202, Method 301.
- Electrical Load Life Expectancy - Contact Littelfuse with voltage, current values along with type of load.
- This resistance value is for 11.81mm wire length. Resistance changes when wire lengthens.
- Operate (including bounce)/Release Time - per EIA/NARM RS-421-A, diode suppressed coil (Coil II).
- Shock and Vibration - per EIA/NARM RS-421-A and MIL-STD-202.
- For custom modifications to the wire length or size, or adding a special connector, please contact Littelfuse.

Activation

| Select Option | Switch Type | Switch Type | |
|---------------|--------------------------------|---------------------------------------|--|
| | | Activation Distance mm (inch) Average | De-Activation Distance mm (inch) Average |
| 1 | Normally Open | 1.4 (055) | 5.5 (.216) |
| 3 | Change Over | 1.4 (055) | 5.5 (.216) |
| 4 | Normally Closed | 1.4 (055) | 5.5 (.216) |
| 5 | High Voltage (Normally Closed) | 1.4 (055) | 5.5 (.216) |

| Schematics | Switch Type |
|--|-------------|
|  Black Black | 1 |
|  Black Blue White | 3 |
|  Black Black | 4 and 5 |

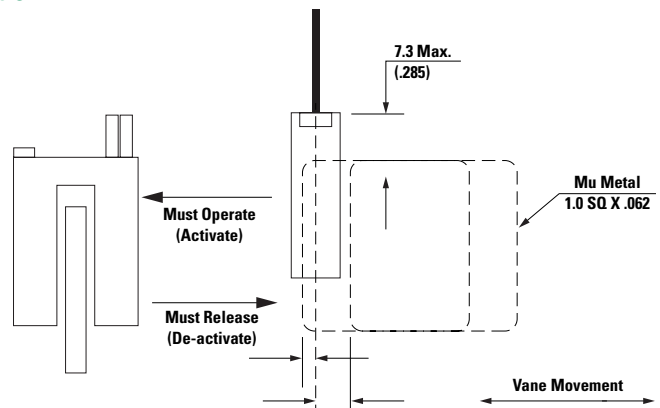

59085

Vane Sensor

Cable Length Specification

| Cable Type: 24 AWG 7/32 PVC 105°C UL1430/UL1569 | |
|---|------------------------|
| Select Option | Cable Length mm (inch) |
| 02 | 300 (11.81) |

Termination Specification

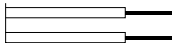
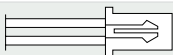
| Termination Options | | |
|---------------------|--|---|
| Select Option | Description (Two-wire versions illustrated) | |
| A | Tinned leads (6.4±0.76)mm |  |
| F | Untinned leads (6.4±0.76)mm |  |
| E | JST type XHP 2.5mm pitch |  |

Part Numbering System

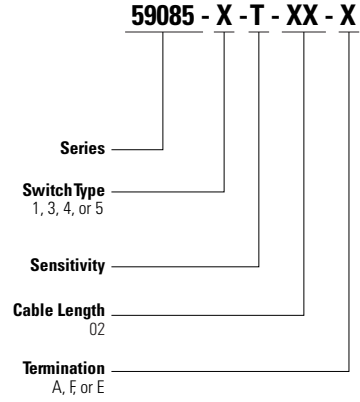

Packaging

| Packaging Option | Packaging Specification | Quantity | Quantity & Packaging Code | Taping Width |
|------------------|-------------------------|----------|---------------------------|--------------|
| Bulk | Bulk | 500 | N/A | N/A |

Disclaimer Notice - Information furnished is believed to be accurate and reliable. However, users should independently evaluate the suitability of and test each product selected for their own applications. Littelfuse products are not designed for, and may not be used in, all applications. Read complete Disclaimer Notice at <http://www.littelfuse.com/disclaimer-electronics>.