

CNY17F-1X, CNY17F-2X, CNY17F-3X, CNY17F-4X  
 CNY17F-1, CNY17F-2, CNY17F-3, CNY17F-4



# ISOCOM

COMPONENTS



## NON-BASE LEAD OPTICALLY COUPLED ISOLATOR PHOTOTRANSISTOR OUTPUT

### APPROVALS

- UL recognised, File No. E91231  
 Package Code GG
- 'X' SPECIFICATION APPROVALS
  - VDE 0884 in 3 available lead forms : -
  - STD
  - G form
  - SMD approved to CECC 00802
- Certified to EN60950 by  
 Nemko - Certificate No. P01102464

### DESCRIPTION

The CNY17F-1, CNY17F-2, CNY17F-3, CNY17F-4 series of optically coupled isolators consist of infrared light emitting diode and NPN silicon photo transistor in a standard 6 pin dual in line plastic package with the base pin unconnected.

### FEATURES

- Options :-
  - 10mm lead spread - add G after part no.
  - Surface mount - add SM after part no.
  - Tape&reel - add SMT&R after part no.
- High  $BV_{CEO}$  (70V min)
- High Isolation Voltage ( $5.3kV_{RMS} > 7.5kV_{PK}$ )
- Base pin unconnected for improved noise immunity in high EMI environment

### APPLICATIONS

- DC motor controllers
- Industrial systems controllers
- Signal transmission between systems of different potentials and impedances

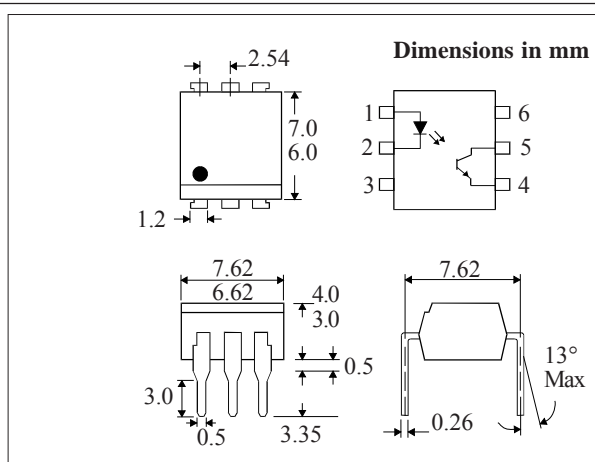

### ABSOLUTE MAXIMUM RATINGS (25°C unless otherwise specified)

Storage Temperature \_\_\_\_\_ -55°C to +150°C  
 Operating Temperature \_\_\_\_\_ -55°C to +100°C  
 Lead Soldering Temperature  
 (1/16 inch (1.6mm) from case for 10 secs) 260°C

### INPUT DIODE

Forward Current \_\_\_\_\_ 60mA  
 Reverse Voltage \_\_\_\_\_ 6V  
 Power Dissipation \_\_\_\_\_ 105mW

### OUTPUT TRANSISTOR

Collector-emitter Voltage  $BV_{CEO}$  \_\_\_\_\_ 70V  
 Emitter-collector Voltage  $BV_{ECO}$  \_\_\_\_\_ 6V  
 Collector Current \_\_\_\_\_ 50mA  
 Power Dissipation \_\_\_\_\_ 160mW

### POWER DISSIPATION

Total Power Dissipation \_\_\_\_\_ 200mW  
 (derate linearly 2.67mW/°C above 25°C)

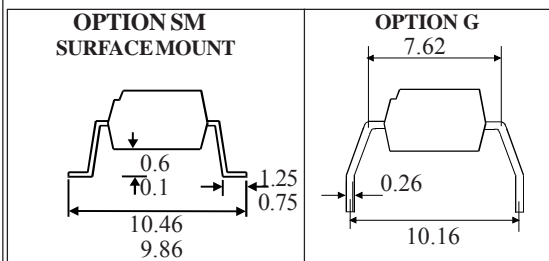

**ISOCOM COMPONENTS LTD**  
 Unit 25B, Park View Road West,  
 Park View Industrial Estate, Brenda Road  
 Hartlepool, TS25 1UD England Tel:  
 (01429)863609 Fax: (01429)863581 e-mail  
 sales@isocom.co.uk http://www.isocom.com

**ELECTRICAL CHARACTERISTICS (  $T_A = 25^\circ\text{C}$  Unless otherwise noted )**

PARAMETER		MIN	TYP	MAX	UNITS	TEST CONDITION
Input	Forward Voltage ( $V_F$ )		1.2	1.65	V	$I_F = 60\text{mA}$
	Reverse Current ( $I_R$ )			10	$\mu\text{A}$	$V_R = 6\text{V}$
Output	Collector-emitter Breakdown ( $BV_{CE0}$ ) ( note 2 )	70			V	$I_C = 1\text{mA}$
	Emitter-collector Breakdown ( $BV_{ECO}$ )	6			V	$I_E = 100\mu\text{A}$
	Collector-emitter Dark Current ( $I_{CEO}$ )			50	nA	$V_{CE} = 10\text{V}$
Coupled	Current Transfer Ratio (CTR) (Note 2)					
	CNY17F-1	40	80		%	$10\text{mA } I_F, 5\text{V } V_{CE}$
	CNY17F-2	63	125		%	$10\text{mA } I_F, 5\text{V } V_{CE}$
	CNY17F-3	100	200		%	$10\text{mA } I_F, 5\text{V } V_{CE}$
	CNY17F-4	160	320		%	$10\text{mA } I_F, 5\text{V } V_{CE}$
	Collector-emitter Saturation Voltage $V_{CE(SAT)}$			0.4	V	$10\text{mA } I_F, 2.5\text{mA } I_C$
	Input to Output Isolation Voltage $V_{ISO}$	5300			$V_{RMS}$	See note 1
	7500			$V_{PK}$	See note 1	
Input-output Isolation Resistance $R_{ISO}$	$5 \times 10^{10}$			$\Omega$	$V_{IO} = 500\text{V}$ (note 1)	

Note 1 Measured with input leads shorted together and output leads shorted together.

Note 2 Special Selections are available on request. Please consult the factory.

**TYPICAL SWITCHING CHARACTERISTICS**

1. Linear Operation (without saturation) Fig 1.  
 $I_F = 10\text{mA}, V_{CC} = 5\text{V}, R_L = 75\Omega$

			UNITS
Turn-on Time	$t_{on}$	3.0	$\mu\text{s}$
Rise Time	$t_r$	2.0	$\mu\text{s}$
Turn-off Time	$t_{off}$	2.3	$\mu\text{s}$
Fall Time	$t_f$	2.0	$\mu\text{s}$
Cut-off Frequency	$F_{CO}$	250	kHz

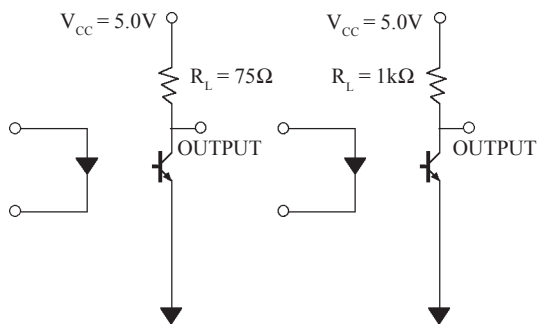
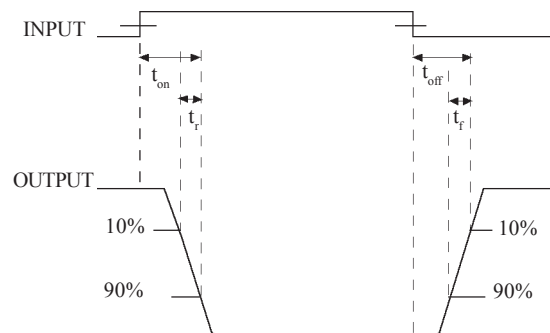

FIG 1

FIG 2

2. Switching Operation (with saturation) Fig 2  
 $V_{CC} = 5\text{V}, R_L = 1\text{k}\Omega$

GROUP	-1 ( $I_F = 20\text{mA}$ )	-2 and -3 ( $I_F = 10\text{mA}$ )	-4 ( $I_F = 5\text{mA}$ )	UNITS	
Turn-on Time	$t_{on}$	3.0	4.2	6.0	$\mu\text{s}$
Rise Time	$t_r$	2.0	3.0	4.6	$\mu\text{s}$
Turn-off Time	$t_{off}$	18	23	25	$\mu\text{s}$
Fall Time	$t_f$	11	14	15	$\mu\text{s}$
$V_{CESAT}$		$\leq 0.4$		V	



**Collector Power Dissipation vs. Ambient Temperature**

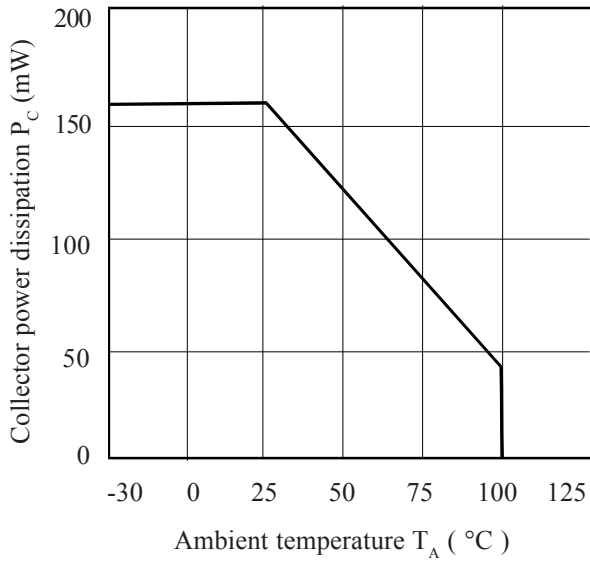

**Collector Current vs. Collector-emitter Voltage (normalised to CNY17F-3)**

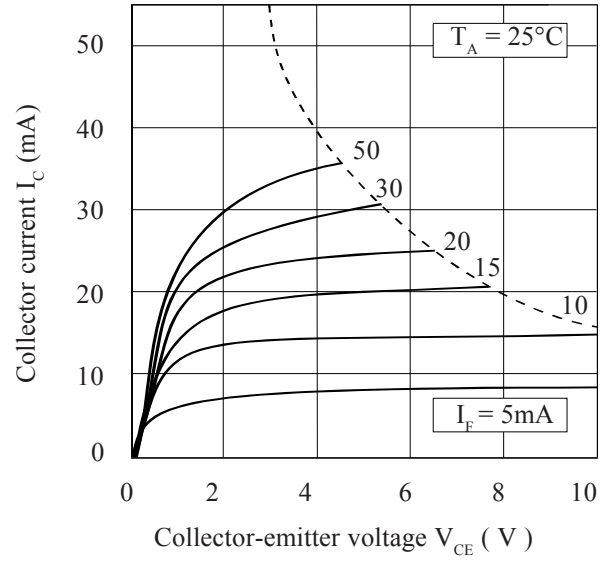

**Forward Current vs. Ambient Temperature**

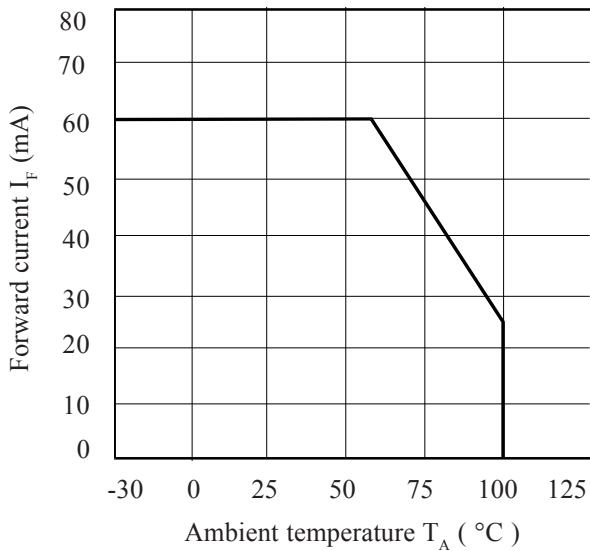

**Current Transfer Ratio vs. Forward Current**

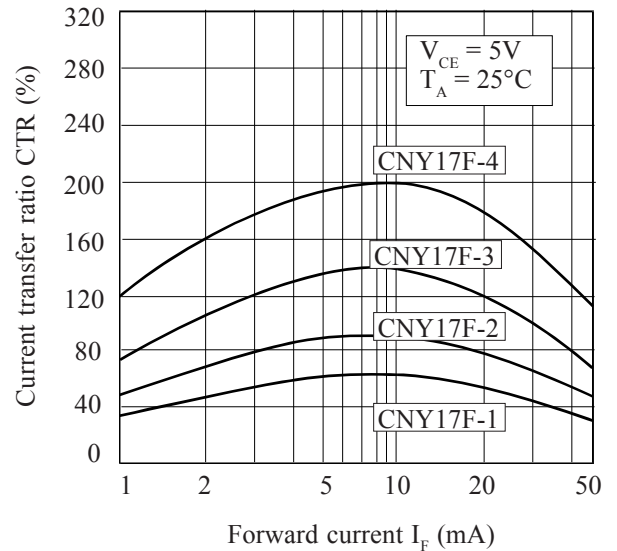

**Relative Current Transfer Ratio vs. Ambient Temperature**

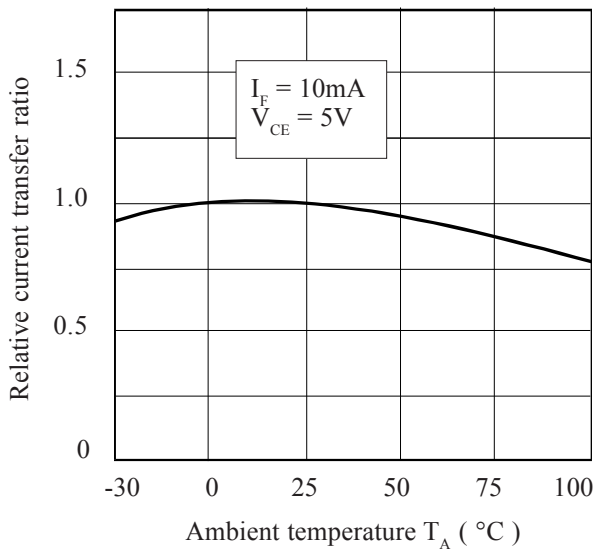

**Collector-emitter Saturation Voltage vs. Ambient Temperature**

