

Automotive ultrafast rectifier

Datasheet - production data

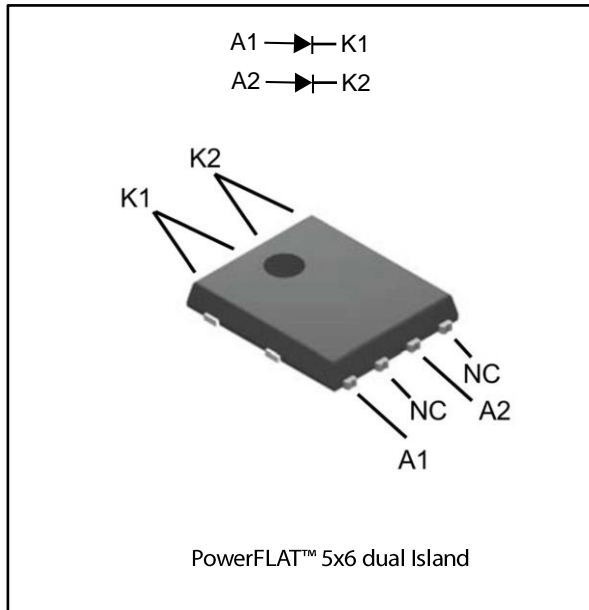

Description

The STTH8L02D-Y is especially suited for switching mode base drive and transistor circuits.

The device is also intended for use as a freewheeling diode in power supplies and other power switching applications in automotive functions.

Table 1: Device summary

Symbol	Value
$I_{F(AV)}$	2 x 4 A
V_{RRM}	200 V
T_j (max.)	175 °C
V_F (typ.)	0.7 V
t_{rr} (typ.)	20 ns

Features

- AEC-Q101 qualified
- Very low conduction losses
- Negligible switching losses
- Low forward voltage
- High junction temperature
- ECOPACK®2 compliant component
- PPAP capable
- Dual Island package
- Wettable flanks for automatic visual inspection



1 Characteristics

Table 2: Absolute ratings (limiting values per diode at 25 °C, unless otherwise specified)

Symbol	Parameter		Value	Unit
V _{RRM}	Repetitive peak reverse voltage	T _j = -40 °C to +175 °C	200	V
I _{F(AV)}	Average forward current	T _c = 160 °C , δ = 0.5 square pulse	4	A
I _{F(RMS)}	Forward rms current		10	A
I _{FSM}	Surge non repetitive forward current	t _p = 10 ms sinusoidal	75	A
T _{stg}	Storage temperature range		-65 to +175	°C
T _j	Maximum operating junction temperature		-40 to +175	°C

Table 3: Thermal resistance parameters

Symbol	Parameter	Maximum	Unit
R _{th(j-c)}	Junction to case	Per diode	4.0
		Total	2.0

Table 4: Static electrical characteristics (per diode)

Symbol	Parameter	Test conditions		Min.	Typ.	Max.	Unit
I _R ⁽¹⁾	Reverse leakage current	T _j = 25 °C	V _R = V _{RRM}	-		3	µA
		T _j = 125 °C		-	2	20	
V _F ⁽²⁾	Forward voltage drop	T _j = 25 °C	I _F = 4 A	-		1	V
		T _j = 125 °C		-		0.85	
		T _j = 150 °C		-	0.7	0.81	
		T _j = 25 °C	I _F = 8 A	-		1.1	
		T _j = 125 °C		-		0.97	
		T _j = 150 °C		-	0.81	0.93	

Notes:

⁽¹⁾Pulse test: t_p = 5 ms, δ < 2%

⁽²⁾Pulse test: t_p = 380 µs, δ < 2%

To evaluate the conduction losses use the following equation:

$$P = 0.70 \times I_{F(AV)} + 0.030 \times I_{F(RMS)}^2$$



For more information, please refer to the following application notes related to the power losses:

- AN604: Calculation of conduction losses in a power rectifier
- AN4021: Calculation of reverse losses in a power diode

Table 5: Dynamic electrical characteristics per diode ($T_j = 25\text{ °C}$, unless otherwise specified)

Symbol	Parameters	Test conditions	Min.	Typ.	Max.	Unit
t_{rr}	Reverse recovery time	$I_F = 1\text{ A}$ $di_F/dt = -50\text{ A}/\mu\text{s}$ $V_R = 30\text{ V}$	-		40	ns
		$I_F = 1\text{ A}$ $di_F/dt = -100\text{ A}/\mu\text{s}$ $V_R = 30\text{ V}$	-	20	28	
		$I_F = 4\text{ A}$ $di_F/dt = -200\text{ A}/\mu\text{s}$ $V_R = 160\text{ V}$		35		
I_{RM}	Reverse recovery current	$di_F/dt = -200\text{ A}/\mu\text{s}$ $V_R = 160\text{ V}$	-	6.8	8.5	A
Q_{rr}	Reverse recovery charge	$T_j = 125\text{ °C}$	-	110		nC

1.1 Characteristics (curves)

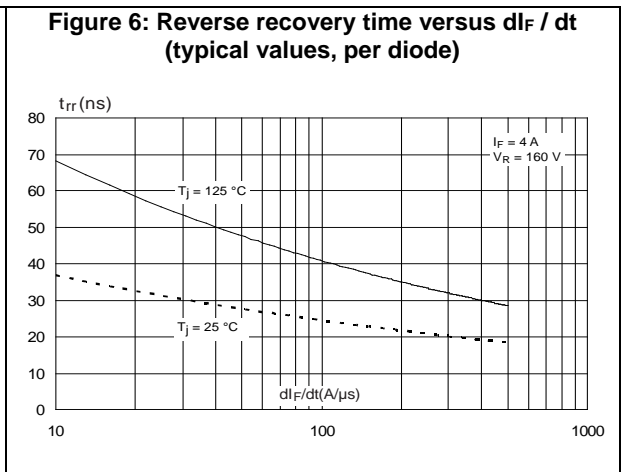
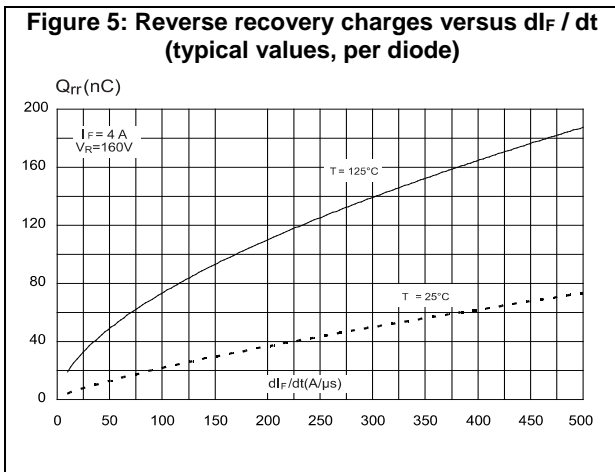
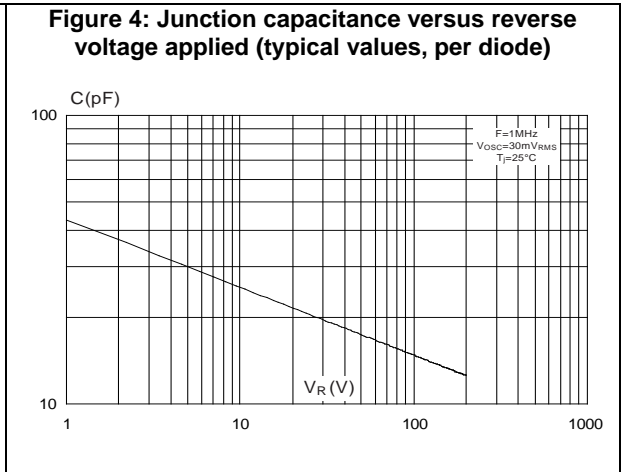
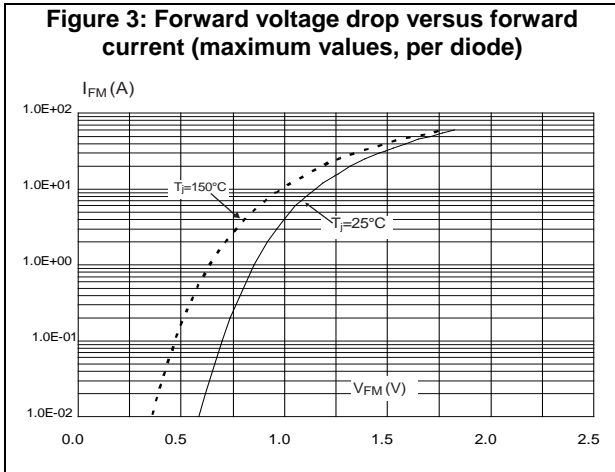
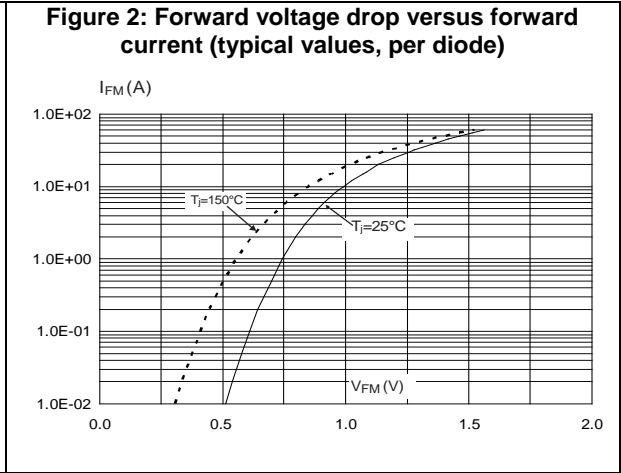
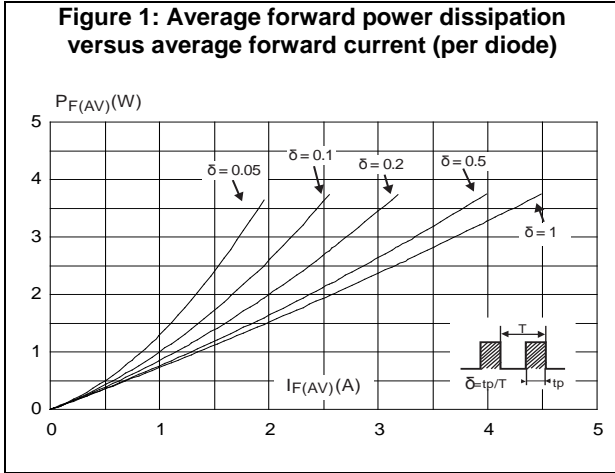

Figure 7: Peak reverse recovery current versus di_F / dt (typical values, per diode)

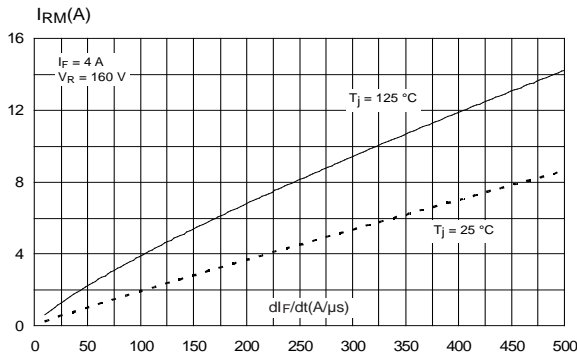

Figure 8: Dynamic parameters versus junction temperature (per diode)

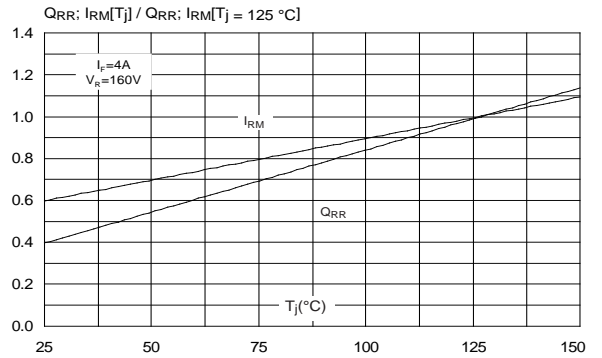

Figure 9: Relative variation of thermal impedance junction to case total versus pulse duration

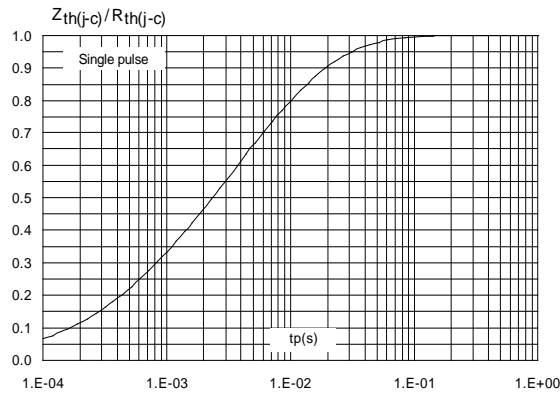
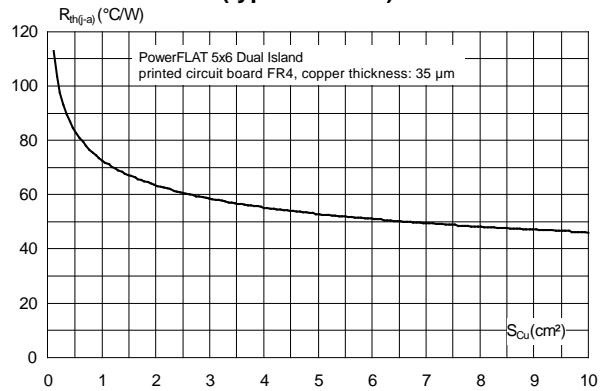

Figure 10: Thermal resistance junction to ambient total versus copper surface under each tab (typical values)



2 Package information

In order to meet environmental requirements, ST offers these devices in different grades of ECOPACK® packages, depending on their level of environmental compliance. ECOPACK® specifications, grade definitions and product status are available at: www.st.com. ECOPACK® is an ST trademark.

2.1 PowerFLAT5x6 dual pad package information

Figure 11: PowerFLAT™ 5x6 dual pad package outline

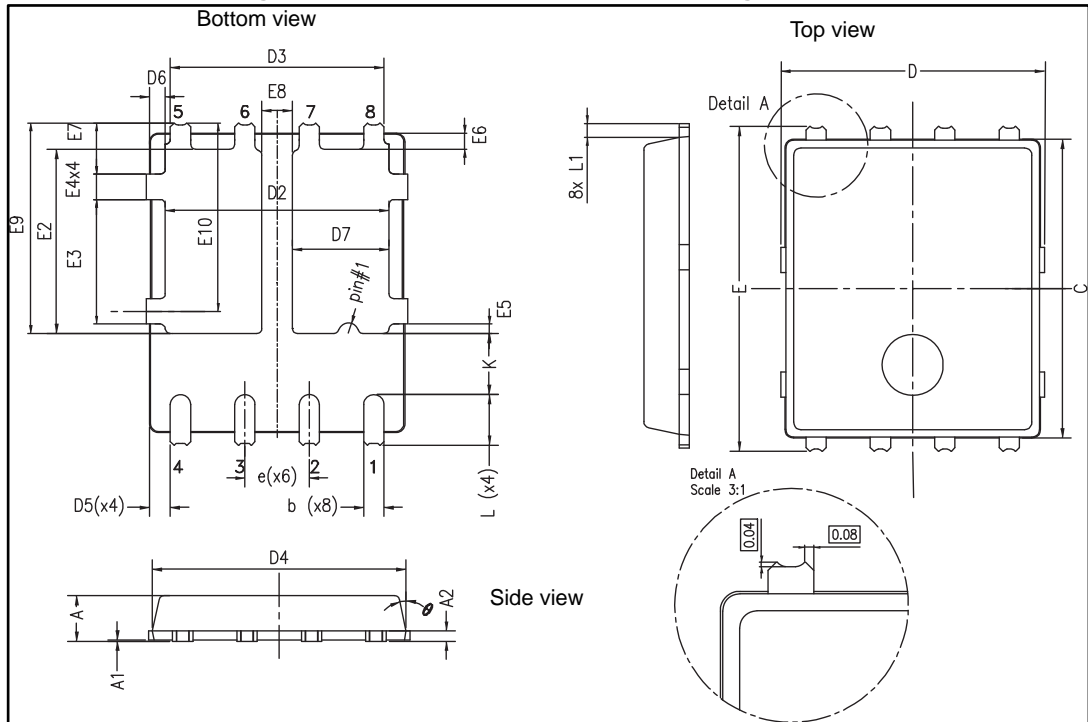
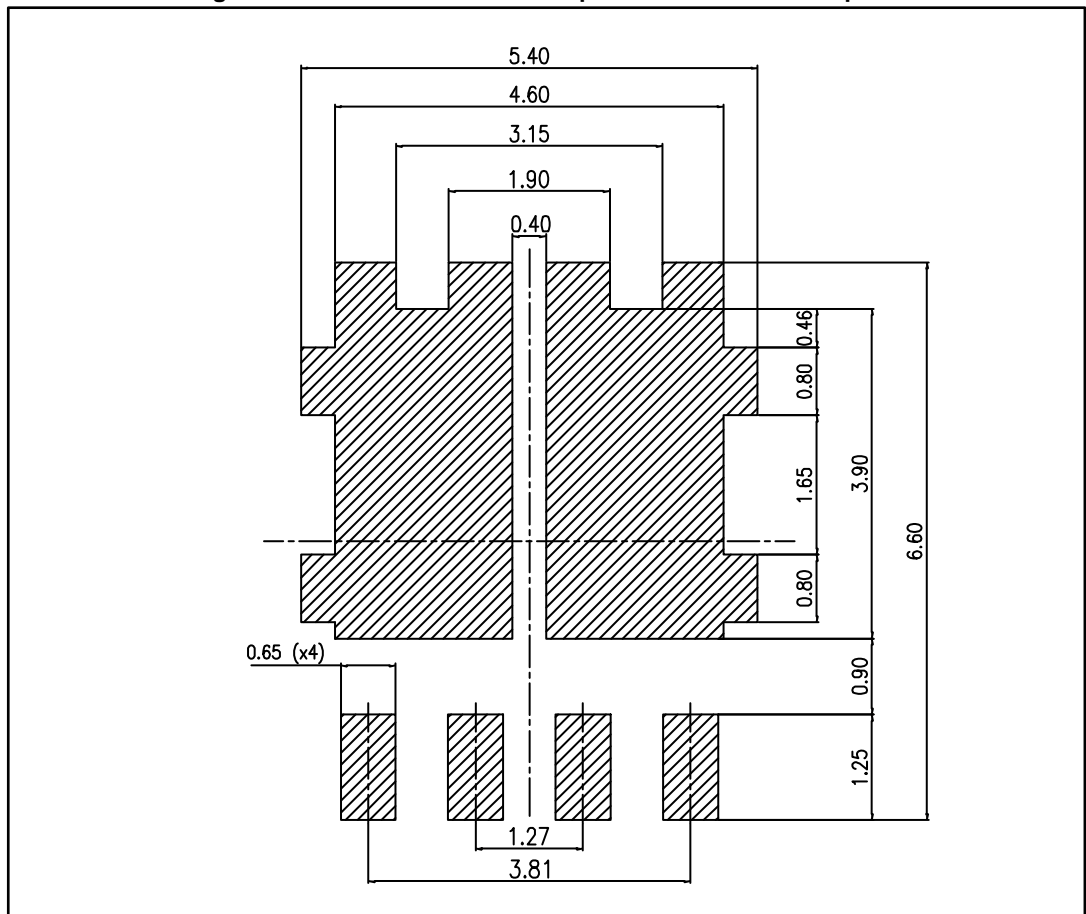

Table 6: PowerFLAT™ 5x6 dual pad package mechanical data

Ref.	Dimensions					
	Millimeters			Inches		
	Min.	Typ.	Max.	Min.	Typ.	Max.
A	0.80		1.00	0.0315		0.0394
A1	0.02		0.05	0.0008		0.0020
A2		0.25			0.0098	
b	0.30		0.50	0.0118		0.0197
C	5.80	6.00	6.10	0.2283	0.2362	0.2402
D	5.00	5.20	5.40	0.1969	0.2047	0.2126
D2	4.15		4.45	0.1634		0.1752
D3	4.05	4.20	4.35	0.1594	0.1654	0.1713
D4	4.80	5.00	5.10	0.1890	0.1969	0.2008
D5	0.25	0.40	0.55	0.0098	0.0157	0.0217
D6	0.15	0.30	0.45	0.0059	0.0118	0.0177
D7	1.68		1.98	0.0661		0.0780
e		1.27			0.0500	
E	6.20	6.40	6.60	0.2441	0.2520	0.2598
E2	3.50		3.70	0.1378		0.1457
E3	2.35		2.55	0.0925		0.1004
E4	0.40		0.60	0.0157		0.0236
E5	0.08		0.28	0.031		0.0110
E6	0.20	0.325	0.45	0.0079	0.0128	0.0177
E7	0.85	1.00	1.15	0.0335	0.0394	0.0453
E8	0.55		0.75	0.0217		0.0295
E9	4.00	4.20	4.40	0.1575	0.1654	0.1732
E10	3.55	3.70	3.85	0.1398	0.1457	0.1516
K	1.05		1.35	0.0502		0.0620
L	0.90	1.00	1.10	0.0285	0.0325	0.0364
L1	0.175	0.275	0.375	0.0069	0.0108	0.0148
θ	0°		12°	0°		12°

Figure 12: PowerFLAT™ 5x6 dual pad recommended footprint



3 Ordering information

Table 7: Ordering information

Order code	Marking	Package	Weight	Base qty.	Delivery mode
STTH8L02DDJFY-TR	TH8L 02DY	PowerFLAT™ 5x6 dual Island	0.095 g	3000	Tape and reel

4 Revision history

Table 8: Document revision history

Date	Revision	Changes
09-Jun-2017	1	First issue

IMPORTANT NOTICE – PLEASE READ CAREFULLY

STMicroelectronics NV and its subsidiaries ("ST") reserve the right to make changes, corrections, enhancements, modifications, and improvements to ST products and/or to this document at any time without notice. Purchasers should obtain the latest relevant information on ST products before placing orders. ST products are sold pursuant to ST's terms and conditions of sale in place at the time of order acknowledgement.

Purchasers are solely responsible for the choice, selection, and use of ST products and ST assumes no liability for application assistance or the design of Purchasers' products.

No license, express or implied, to any intellectual property right is granted by ST herein.

Resale of ST products with provisions different from the information set forth herein shall void any warranty granted by ST for such product.

ST and the ST logo are trademarks of ST. All other product or service names are the property of their respective owners.

Information in this document supersedes and replaces information previously supplied in any prior versions of this document.

© 2017 STMicroelectronics – All rights reserved