

## Evaluating the AD7175-8 24-Bit, 250 kSPS, Sigma-Delta ADC with 20 $\mu$ s Settling and Integrated Analog Input Buffers

### FEATURES

Full featured evaluation board for the [AD7175-8](#)  
 PC control in conjunction with the Analog Devices, Inc.,  
 SDP-B board ([EVAL-SDP-CB1Z](#))  
 PC software for control and data analysis (time domain)  
 Standalone capability

### EVALUATION KIT CONTENTS

[EVAL-AD7175-8SDZ](#) evaluation board  
 AD717x Eval+ software CD  
 7 V to 9 V ac-to-dc adapter

### ADDITIONAL EQUIPMENT NEEDED

DC signal source  
 PC running Windows® XP to Windows 10

### GENERAL DESCRIPTION

The [EVAL-AD7175-8SDZ](#) evaluation board features the [AD7175-8](#), a 24-bit, 250 kSPS analog-to-digital converter (ADC) with integrated analog input buffers, on-board power supply regulation, and an external amplifier section for amplifier evaluation. A 7 V to 9 V ac-to-dc adapter is regulated to 5 V and 3.3 V; this supplies the [AD7175-8](#) and support components. The evaluation board connects to a USB port via the system demonstration platform (SDP) controller board [EVAL-SDP-CB1Z](#) ([SDP-B](#)).

The AD717x Eval+ software fully configures the [AD7175-8](#) device functionality via a user accessible register interface and provides dc time domain analysis in the form of waveform graphs, histograms, and associated noise analysis for ADC performance evaluation.

Full specifications on the [AD7175-8](#) are available in the product data sheet, which should be consulted in conjunction with this user guide when working with the evaluation board. Full details for the SDP-B controller board are available on the Analog Devices website.

### FUNCTIONAL BLOCK DIAGRAM

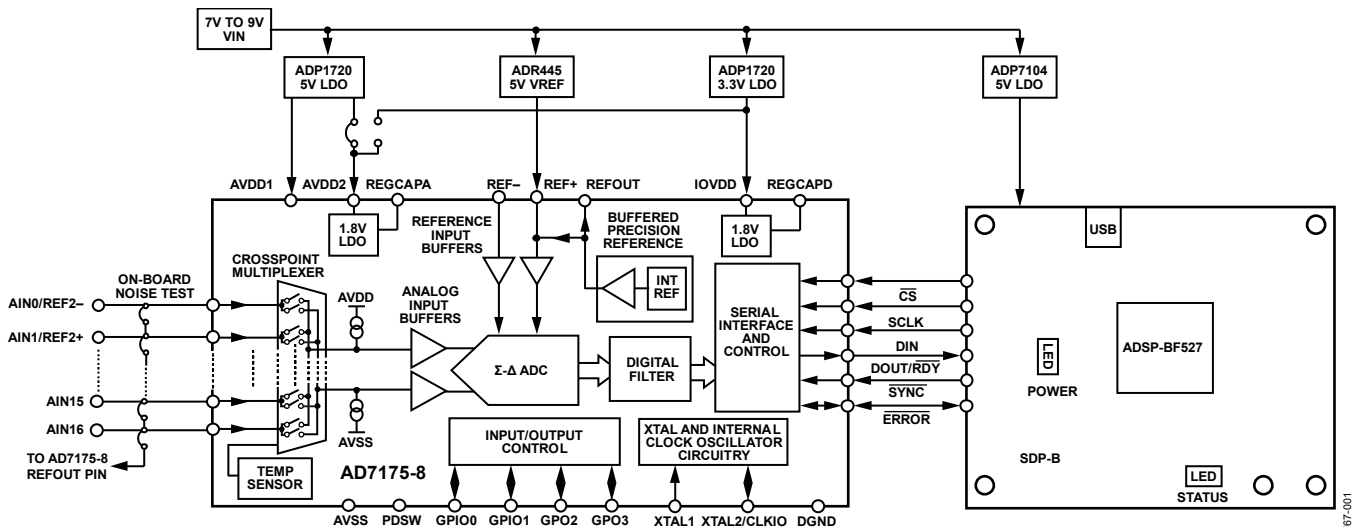

Figure 1. EVAL-AD7175-8SDZ Block Diagram

## TABLE OF CONTENTS

Features .....	1	Reference Options .....	6
Evaluation Kit Contents.....	1	Evaluation Board Software.....	7
Additional Equipment Needed.....	1	Software Installation .....	7
General Description .....	1	Setting up the System for Data Capture .....	9
Functional Block Diagram .....	1	Launching the Software .....	9
Revision History .....	2	Evaluation Board Software Operation.....	10
EVAL-AD7175-8SDZ Quick Start Guide.....	3	Overview of the Main Window.....	11
Recommended Quick Start Guide .....	3	Configuration Tab (1).....	11
Quick Start Noise Test .....	3	Waveform Tab (18).....	13
Evaluation Board Hardware .....	4	Histogram Tab (28).....	15
Device Description.....	4	Modelled Performance Tab (31).....	16
Hardware Link Options.....	4	Registers Tab (45).....	19
Sockets and Connectors .....	5	Exiting the Software .....	19
Serial Interface .....	5	Evaluation Board Schematics and Artwork.....	20
Power Supplies .....	5	Ordering Information.....	29
Power Supply Configurations .....	6	Bill of Materials.....	29
Analog Inputs.....	6		

## REVISION HISTORY

### 1/2018—Rev. 0 to Rev. A

Changed AD7175-8Evaluation Software to AD717x Eval+ Software .....	Throughout
Changed EVAL-SDP-CBIZ to SDP-B.....	Throughout
Changes to Evaluation Kit Contents, Additional Equipment Needed, and General Description .....	1
Changes to Software Installation Section, Figure 3, Figure 4, and Figure 4 Caption .....	7
Added Figure 5 and Figure 6; Renumbered Sequentially .....	7
Added Figure 7 through Figure 11 .....	8
Added Setting up the System for Data Capture Section.....	9
Added Figure 13 and Figure 15.....	9
Changes to Launching the Software Section, Figure 12, Figure 12 Caption, Figure 14, and Figure 14 Caption.....	9
Changes to Software Operation Section to Evaluation Board Software Operation Section .....	10

Changes to Figure 16.....	10
Added Figure 17 .....	11
Added Overview of the Main Window Section and Configuration Tab (1) Section .....	13
Added Waveform Tab (18) Section and Figure 18.....	14
Added Histogram Tab (26) Section and Figure 19 .....	15
Added Modelled Performance Tab (31) Section and Figure 20.....	16
Added Figure 21 .....	17
Added Figure 22 .....	18
Added Registers Tab (45) Section and Figure 23 .....	19
Added Evaluation Board Schematics and Artwork Section .....	20
Added Ordering Information Section and Table 4.....	29

### 11/2015—Revision 0: Initial Version

## EVAL-AD7175-8SDZ QUICK START GUIDE

### RECOMMENDED QUICK START GUIDE

Follow these steps to set up the board:

1. Disconnect the SDP-B board from the USB port of the PC. Install the AD717x Eval+ software from the enclosed CD. Restart the PC after installation.
2. Connect the SDP-B board to the [EVAL-AD7175-8SDZ](#) evaluation board, as shown in Figure 2.
3. Fasten the two boards together with the enclosed plastic screw washer set.
4. Connect the external 9 V power supply to Connector J4 of the evaluation board, as shown in Figure 2. Set LK2 to Position B.
5. Connect the SDP-B board to the PC via the USB cable. For Windows® XP, you may need to search for the SDP drivers. Choose to automatically search for the drivers for the SDP-B board if prompted by the operating system.
6. From the **Analog Devices** subfolder in the **Programs** menu, launch the AD717x Eval+ software.

### QUICK START NOISE TEST

Use the following procedure to quickly test the noise performance:

1. Insert Link LK5 to Link LK20 to initiate the noise performance test mode. In this mode, analog input channels short to the REFOUT pin via SL11.
2. In the evaluation software, click **Start Sampling** to acquire samples from the ADC (see Figure 16).

The **Samples** numeric control in the top right corner of the main window sets the number of samples collected in each batch.

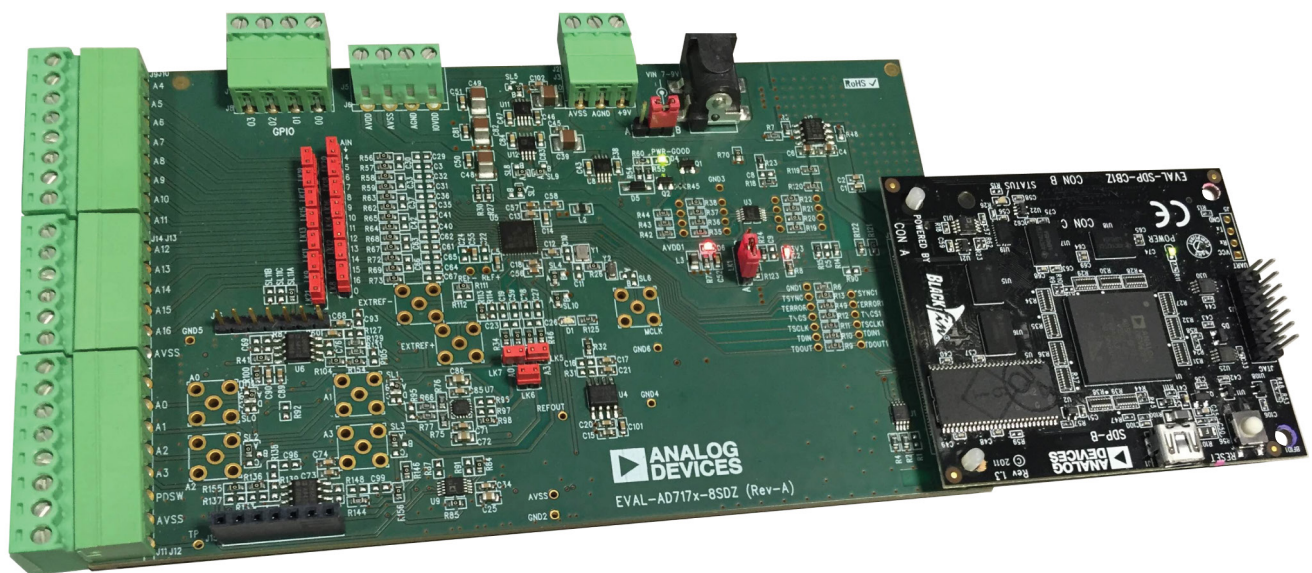

Figure 2. Hardware Configuration, Setting Up the [EVAL-AD7175-8SDZ](#)

## EVALUATION BOARD HARDWARE

### DEVICE DESCRIPTION

The [AD7175-8](#) is a highly accurate, high resolution, multiplexed, 8-/16-channel (full/pseudo differential)  $\Sigma$ - $\Delta$  ADC. The [AD7175-8](#) has a maximum channel-to-channel scan rate of 50 kSPS (20  $\mu$ s) for fully settled data. The output data rates range from 5 SPS to 250 kSPS. The device includes integrated analog input and reference buffers, an integrated precision 2.5 V reference, and an integrated oscillator.

### HARDWARE LINK OPTIONS

See Table 1 for the default link options. By default, the board is configured to operate from the supplied 9 V ac-to-dc adapter connected to Connector J4. The 5 V supply required for the [AD7175-8](#) comes from the on-board low dropout regulator (LDO). The [ADP1720](#), with a 5 V fixed output voltage, receives its input voltage from J2 or J4 (depending on the position of LK2) and generates a 5 V output.

**Table 1. Default Link and Solder Link Options**

Link	Default Option	Description
LK1	A	Selects the voltage applied to the power supply sequencer circuit (U3); dependent on AVDD1. Place this link in Position A if using 5 V AVDD1, or Position B if using 2.5 V AVDD1.
LK2	B	Selects the external power supply from Connector J3 (Position A), or J4 (Position B).
LK5 to LK20	Inserted	Inserting these links sets up the on-board noise test. In this mode, all inputs short to the common voltage via SL11.
SL0	A	Routes A0 to one of the following: Position A: AIN0/REF2– pin on the <a href="#">AD7175-8</a> Position B: Buffer U6 Position C: U7 for use with a single-ended to differential driver circuit Position D: J15-1
SL1	A	Routes A1 to one of the following: Position A: AIN1/REF2+ pin on the <a href="#">AD7175-8</a> Position B: Buffer U6 Position C: U7 for use with a single-ended to differential driver circuit Position D: J15-7
SL2	A	Routes A2 to one of the following: Position A: AIN2 pin on the <a href="#">AD7175-8</a> Position B: Buffer U10 Position C: U9 for use with a single-ended to differential driver circuit
SL3	A	Routes A3 to one of the following: Position A: AIN3 pin on the <a href="#">AD7175-8</a> Position B: Buffer U10 Position C: U9 for use with a single-ended to differential driver circuit
SL4	A	Sets the voltage applied to the AVDD2 pin. Operates using the AVDD1 supply (default). Position B sets the AVDD2 voltage to the 3.3 V supply from the <a href="#">ADP1720</a> 3.3 V regulator (U11).
SL5	B	Selects between an external or on-board IOVDD source. Supplies IOVDD from the <a href="#">ADP1720</a> 3.3 V regulator (U11) (default). The evaluation board operates with a 3.3 V logic.
SL6	Removed	Position A connects Crystal Y1 as an external MCLK clock source. Position B connects the MCLK SMA/SMB connector for use as a clock input or an ADC internal clock output.
SL7	A	Selects between an external or on-board AVDD1 source. Supplies AVDD1 from the <a href="#">ADP1720</a> 5 V regulator (U8) (default).
SL8 to SL9	A	Selects between a 5 V and 2.5 V LDO supply for AVDD1. Supplies AVDD1 with 5 V (default).
SL10	A	Selects the voltage applied to the AVDD1 pin. Operates using the supply set up by Link SL8 to Link SL9 (default). When inserted in Position B, sets the AVDD1 voltage to the 3.3 V supply from the <a href="#">ADP1720</a> 3.3 V regulator.
SL11	A	Selects the voltage applied to analog input during on-board noise test (LK5 to LK20 inserted). Position A connects to the <a href="#">AD7175-8</a> REFOUT pin. Position B connects to GND. Position C connects to AVSS.
SL12 to SL15	Inserted	Connects AVSS and AGND for single-supply operation. To operate in split supply mode, remove these links.

## SOCKETS AND CONNECTORS

Table 2. Connector Details

Connector	Function	Connector Type	Manufacturer	Manufacturer Number	Order Code <sup>1</sup>
J1	Connector to the <a href="#">SDP-B</a>	120-way connector, 0.6 mm pitch	Hirose	FX8-120S-SV(21)	FEC1324660
A0 to A3	Analog inputs to the ADC	Straight PCB mount SMB/SMA jack	Tyco	1-1337482-0	Not applicable
J3	External bench top voltage supply for the <a href="#">EVAL-AD7175-8SDZ</a>	Power socket block, 3-pin, 3.81 mm pitch	Phoenix Contact	MC 1,5/ 3-G-3,81	FEC3704757
J4	External ac-to-dc adapter input for the <a href="#">EVAL-AD7175-8SDZ</a> , 7 V to 9 V	DC power connectors, 2 mm SMT power jack	Kycon	KLDX-SMT2-0202-A	MOUSER 806-KLDX-SMT20202A
J5	External bench top voltage supply option for AVDD1/AVDD2 and IOVDD inputs on the <a href="#">AD7175-8</a>	Screw terminal block, 3.81 mm pitch	Phoenix Contact	MKDS 1/4-3.81	FEC3704592
J8	GPIO terminal	Power socket block, 4-pin, 3.81 mm pitch	Phoenix Contact	MC 1,5/ 4-G-3,81	FEC3704749
J10 and J12	Analog input terminal block; wired connection to external source or sensor	Power socket block, 8-pin, 3.81 mm pitch	Phoenix Contact	MC 1,5/ 8-G-3,81	FEC3704774
J14	Analog input terminal block; wired connection to external source or sensor	Power socket block, 6-pin, 3.81 mm pitch	Phoenix Contact	MC 1,5/ 6-G-3,81	FEC3704762
J15	Optional header	7-way, 2.54 mm pin header	Samtec	SSW-107-01-T-S	FEC1803478
J16	Optional header	7-way, 2.54 mm socket	Samtec	TLW-107-05-G-S	FEC1668499

<sup>1</sup> Order codes starting with FEC are for Farnell.

### SERIAL INTERFACE

The [EVAL-AD7175-8SDZ](#) evaluation board connects to the Blackfin® [ADSP-BF527](#) on the SDP-B controller board via the serial peripheral interface (SPI). There are four primary signals, CS, SCLK, and DIN (all inputs), and one output from the ADC, DOUT/RDY.

To operate the evaluation board in standalone mode, disconnect the [AD7175-8](#) serial interface lines from the 120-pin header by removing the 0 Ω, R9 through R13 links. Use the test points to connect the signals to an alternative digital capture setup.

### POWER SUPPLIES

Power the evaluation board from the ac-to-dc adapter connected to J4, or from an external bench top supply applied to J3 or J5. Linear LDOs generate the required voltages from the applied input voltage ( $V_{IN}$ ) rail when using J3 or J4. Use J5 to bypass the on-board regulators. The regulators used are the 5 V fixed output voltage and 2.5 V adjustable output voltage [ADP1720](#) devices, which supply the AVDD1 and AVDD2 rails to the ADC; the [ADP1720](#) (3.3 V) supplies the IOVDD rail. Use the [ADP7104](#) (5 V) to supply 5 V for the SDP-B controller board. Each supply is decoupled where it enters the board and again at each device. Table 3 shows the various power supply configurations available, including split supply operation.

Table 3. Power Supply Configurations<sup>1</sup>

Configuration	Input Voltage Range	Description
Single Supply (Regulated)	7 V to 9 V	The 7 V to 9 V input is regulated to 5 V for AVDD1/AVDD2 and 3.3 V for IOVDD. This supply also powers the external 5 V reference. See the Single Supply (Regulated) section.
Single Supply (Unregulated)	7 V to 9 V, 5 V, and 3.3 V	The input is unregulated and connects directly to AVDD1/AVDD2 and IOVDD from J5. The 7 V to 9 V input powers the external 5 V reference. See the Single Supply (Unregulated) section.
Split Supply (Regulated)	7 V to 9 V and -2.5 V	The 7 V to 9 V input is regulated to 2.5 V for AVDD1/AVDD2 and 3.3 V for IOVDD. The 7 V to 9 V input powers the external 5 V reference, and the -2.5 V input is connected to AVSS directly (unregulated). See the Split Supply (Regulated) section.
Split Supply (Unregulated)	7 V to 9 V, ±2.5 V, and 3.3 V	The input is unregulated and connects directly to AVDD1/AVDD2 and IOVDD from J5. The 7 V to 9 V input powers the external 5 V reference. See the Split Supply (Unregulated) section.

<sup>1</sup> Only one configuration can be used at a time.

## POWER SUPPLY CONFIGURATIONS

### Single Supply (Regulated)

There are two available power supply options for the single-supply (regulated) configuration.

- An ac-to-dc adapter (included) connected to J4. Set LK2 to Position B.
- A bench top power supply connected to J3. Set LK2 to Position A and ensure that AVSS = AGND = 0 V.

Set all other links and solder links to the default settings as outlined in Table 1.

### Single Supply (Unregulated)

To set up the board, use the following procedure:

1. Move SL5 to Position A and SL7 to Position B.
2. Connect the two terminals of J5 labeled AGND and AVSS.
3. Connect 0 V (GND) to J5 at the terminal labeled AGND.
4. Connect 5 V to J5 at the terminal labeled AVDD.
5. Connect 3.3 V to J5 at the terminal labeled IOVDD.
6. Connect the 7 V to 9 V input to either J3 or J4.

Set all other links and solder links to the default settings as outlined in Table 1.

### Split Supply (Regulated)

To set up the board, use the following procedure:

1. Remove SL12 to SL15. These links connect AVSS to AGND.
2. Connect a bench top power supply to J3 and set LK2 to Position A. Make sure that AVSS = -2.5 V in this case.
3. Set LK1 to Position B. This sets the input to the power monitor circuitry to work with the lower AVDD1 supply of 2.5 V.

Set all other links and solder links to the default settings as outlined in Table 1.

### Split Supply (Unregulated)

To set up the board, use the following procedure:

1. Move SL5 to Position A and move SL7 to Position B.
2. Remove SL12 to SL15.
3. Connect 0 V (GND) to J5 at the terminal labeled AGND.
4. Connect 2.5 V to J5 at the terminal labeled AVDD.
5. Connect -2.5 V to J5 at the terminal labeled AVSS.
6. Connect 3.3 V to J5 at the terminal labeled IOVDD.
7. Connect 7 V to 9 V to either J3 or J4. Connect or disconnect the AVSS terminal of J3 to the AVSS terminal of J5.
8. Set LK1 to Position B. This sets the input to the power monitor circuitry to work with the lower AVDD1 supply of 2.5 V.

Set all other links and solder links set to the default settings as outlined in Table 1.

## ANALOG INPUTS

The [EVAL-AD7175-8SDZ](#) primary analog inputs can be applied in two separate ways:

- J10, J12, and J14 connectors on the left side of the board
- A0 to A3 SMB/SMA footprints on the evaluation board

The analog inputs route directly to the associated analog input pins on the [AD7175-8](#), provided that the LK5 to LK20 links (on-board noise test) are removed. The [AD7175-8](#) evaluation software is set up to analyze dc inputs to the ADC. The [AD7175-8](#) input buffers work for dc input signals.

## REFERENCE OPTIONS

The [EVAL-AD7175-8SDZ](#) includes an external 5 V reference, the [ADR445](#). The [AD7175-8](#) includes an internal 2.5 V reference. The default operation is to use the external reference input, which is set to accept the 5 V [ADR445](#) on the evaluation board.

Choose the reference in the SETUPCONx registers associated with Setup 0 to Setup 7 to select the reference used for conversions by the [AD7175-8](#).

Change between the internal and external references by accessing the [AD7175-8](#) register map in the evaluation software.

# EVALUATION BOARD SOFTWARE

## SOFTWARE INSTALLATION

The EVAL-AD7175-8SDZ evaluation kit includes software on a CD. Double-click the **setup.exe** file from the CD to run the installer. The default installation location for the software is **C:\Program Files\Analog Devices\AD717x Eval+**.

Install the AD717x Eval+ software before connecting the evaluation board and SDP-B board to the USB port of the PC to ensure that the evaluation system is correctly recognized when connected to the PC.

There are two parts to the installation.

1. AD717x Eval+ software installation.
2. AD717x Eval+ Dependencies
  - a. SDP-B board drivers
  - b. Ssrc SVG plug-in installation
  - c. Microsoft .Net Framework v3.5

### Warning

To ensure the PC correctly recognizes the evaluation system, the evaluation software drivers must be installed before connecting the EVAL-AD7175-8SDZ evaluation board and SDP-B boards to the USB port of the PC.

### Installing the AD717x Eval+ Software

To install the AD717x Eval+ software take the following steps:

1. With the SDP-B disconnected from the USB port of the PC, insert the AD717x Eval+ software installation CD into the CD-ROM drive. Double-click the **setup.exe** file to begin the evaluation board software installation.
2. The default installation location for the software is **C:\Program Files\Analog Devices\AD717x Eval+**.
3. A dialog box appears asking for permission to allow the program to make changes to the PC. Click **Yes** to proceed (see Figure 3).

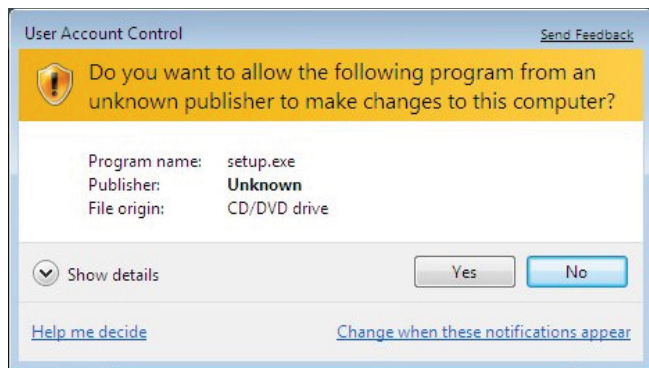

Figure 3. User Account Control Permission Dialog Box

4. Select a location to install the software and click **Next**. Figure 4 shows the default locations displayed when the dialog box opens. To select another location click **Browse**.

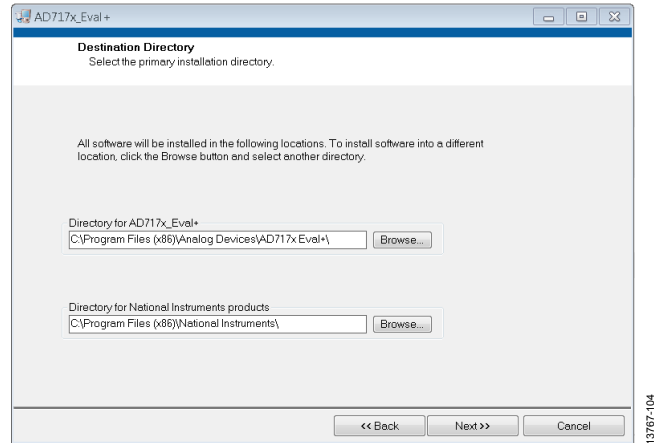

Figure 4. AD717x Eval+ Installation, Selecting the Location for Software Installation

5. A license agreement appears. Read the agreement, select **I accept the License Agreement**, and click **Next**.

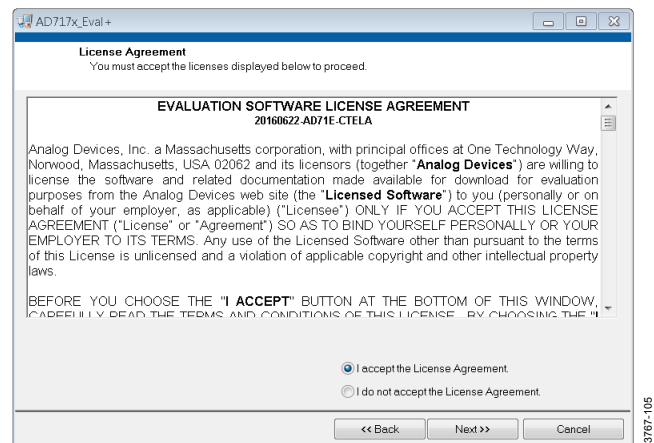

Figure 5. AD717x Eval+ Installation, Accepting the License Agreement

6. A summary of the installation displays. Click **Next** to continue.

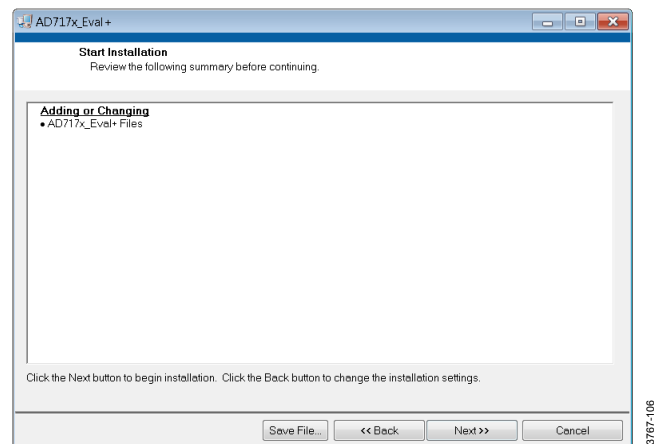

Figure 6. AD717x Eval+ Installation, Reviewing a Summary of the Installation

- The message in Figure 7 appears when the installation is complete.

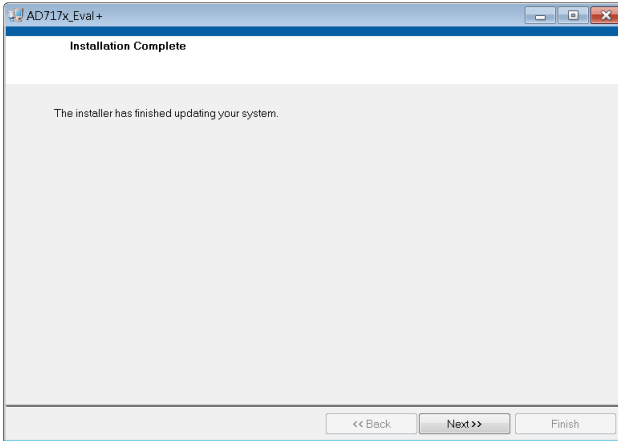

Figure 7. AD717x Eval+ Installation Complete

### Installing the Eval+ Dependencies

After installation of the evaluation software is complete, a welcome window displays to install the **Eval+ Dependencies**.

- With the **SDP-B** board still disconnected from the USB port of the PC, make sure all other applications are closed, then click **Install**.

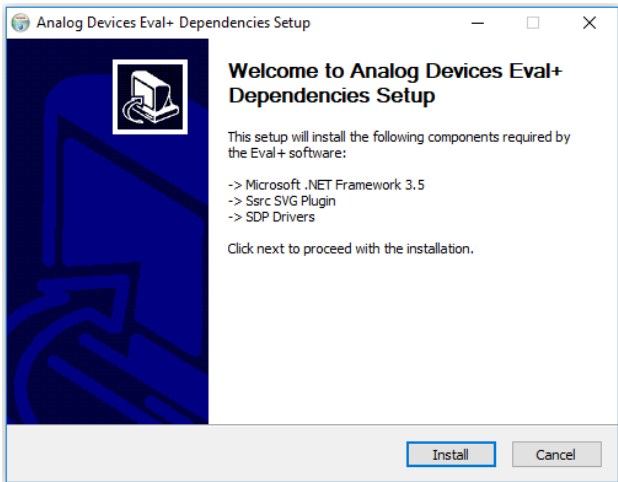

Figure 8. Eval+ Dependencies Setup, Beginning the Drivers Installation

- The Src SVG plug-in will install first, then the **SDP-B** drivers, and finally the .Net Framework.
- If using Windows 8 or Windows 10 see the Installing the .Net Framework v3.5 on Windows 8 and Windows 10 section.
- To complete the drivers installation click **Close**. This closes the installation setup wizard.

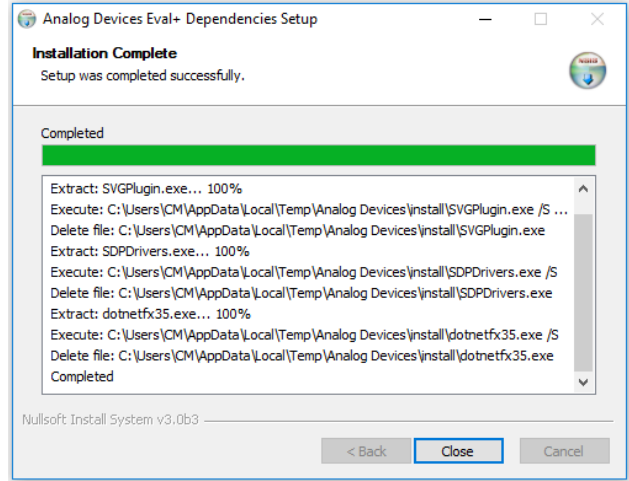

Figure 9. Eval+ Dependencies Setup, Completing the Driver Setup Wizard

- Before using the evaluation board, the user must restart the PC.

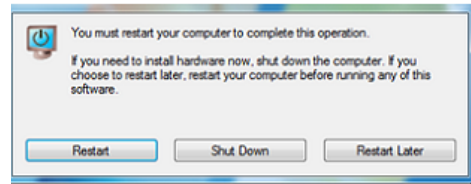

Figure 10. Restarting the PC

### Installing the .Net Framework v3.5 on Windows 8 and Windows 10

Windows 8 and Windows 10 have a built in installer for the .Net Framework v3.5. In order to run this software the user will need an internet connection and may need administrator privileges. Complete the following steps to install the software. If unable to install the .Net Framework contact your system administrator.

- When the Eval+ Dependencies installer reaches the .Net Framework, the window shown in Figure 11 will appear.

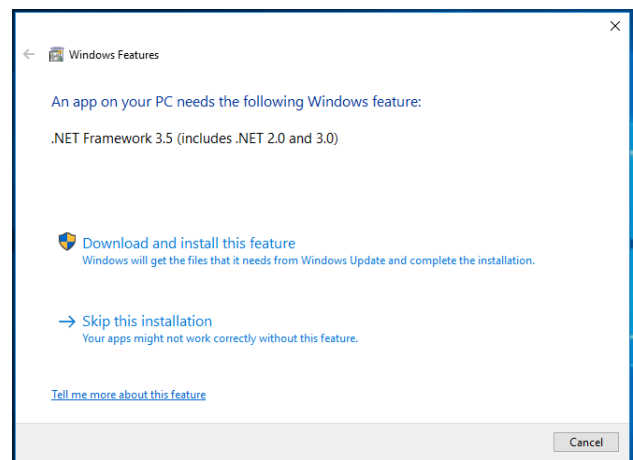

Figure 11. Restarting the PC

- Follow the steps in the installation wizard to complete the installation.



- If the window in Figure 11 does not appear; v3.5 may already be installed. To check if the software is already installed open **Control Panel > Programs > Programs and Features** and select **Turn Windows features on or off**. Check that the .Net Framework v3.5 is enabled.

**SETTING UP THE SYSTEM FOR DATA CAPTURE**

After completing the steps in the Software Installation section and the Evaluation Board Hardware section, set up the system for data capture using the following steps.

- Allow the **Found New Hardware Wizard** to run after the **SDP-B** board is connected to the PC. (If using Windows XP, search for the **SDP-B** drivers. Choose to automatically search for the drivers if prompted by the operating system.)
- Check that the board is connecting to the PC correctly using the **Device Manager**.
- Access the **Device Manager** by right clicking **My Computer**, then **Manage**. A dialog box appears asking for permission to allow the program to make changes to the PC. Click **Yes**. The **Computer Management** box appears. Click **Device Manager** from the list of **System Tools** (see Figure 12).
- The **SDP-B** board appears under **ADI Development Tools**. This indicates that the driver software has installed and the board is connected to the PC correctly.

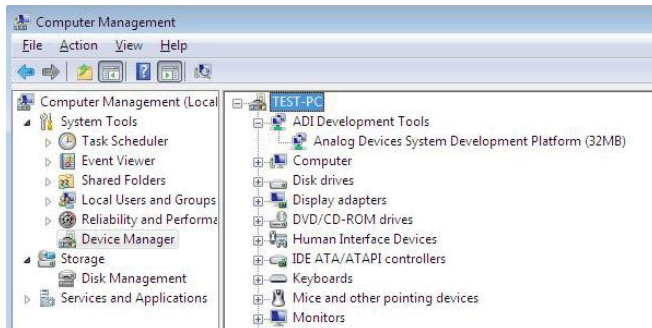

Figure 12. Device Manager, Checking the Board Connected to the PC Correctly

**LAUNCHING THE SOFTWARE**

After completing the steps in the Setting up the System for Data Capture section, launch the AD717x Eval+ software using the following steps:

- From the **Start** menu, click **Programs > Analog Devices > AD717x Eval+**.
- The dialog box in Figure 13 appears, select **AD7175 Evaluation Board**. The main window of the software box displays as shown in Figure 16.

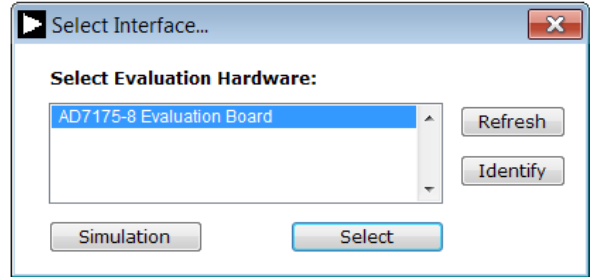

Figure 13. AD7175-8 Evaluation Board Selection

- If the **EVAL-AD7175-8SDZ** evaluation system is not connected to the USB port via the **SDP-B**, when the software is launched the **Select Interface** dialog box appears (see Figure 14). Connect the evaluation board to the USB port of the PC, wait a few seconds, click **Refresh** and the option shown in Figure 13 appears.

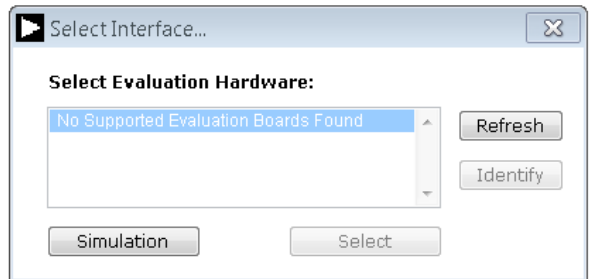

Figure 14. Evaluation Board Selection, No Board Connected

- The AD717x Eval+ software can also be used without connecting hardware. Click the **Simulation** button and the options shown in Figure 15 appear. This simulation mode uses a model and allows the **AD7172-2**, **AD7172-4**, **AD7173-8**, **AD7175-2**, **AD7175-8**, **AD7176-2**, or **AD7177-2** to be evaluated.

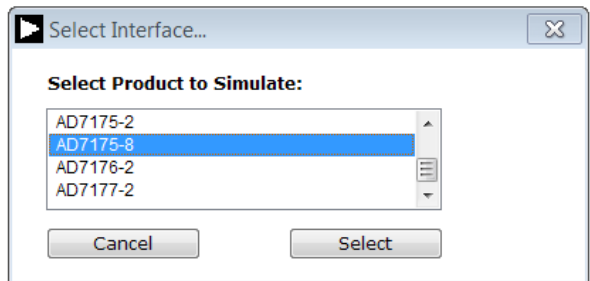

Figure 15. Evaluation Board Selection Simulation

# EVALUATION BOARD SOFTWARE OPERATION

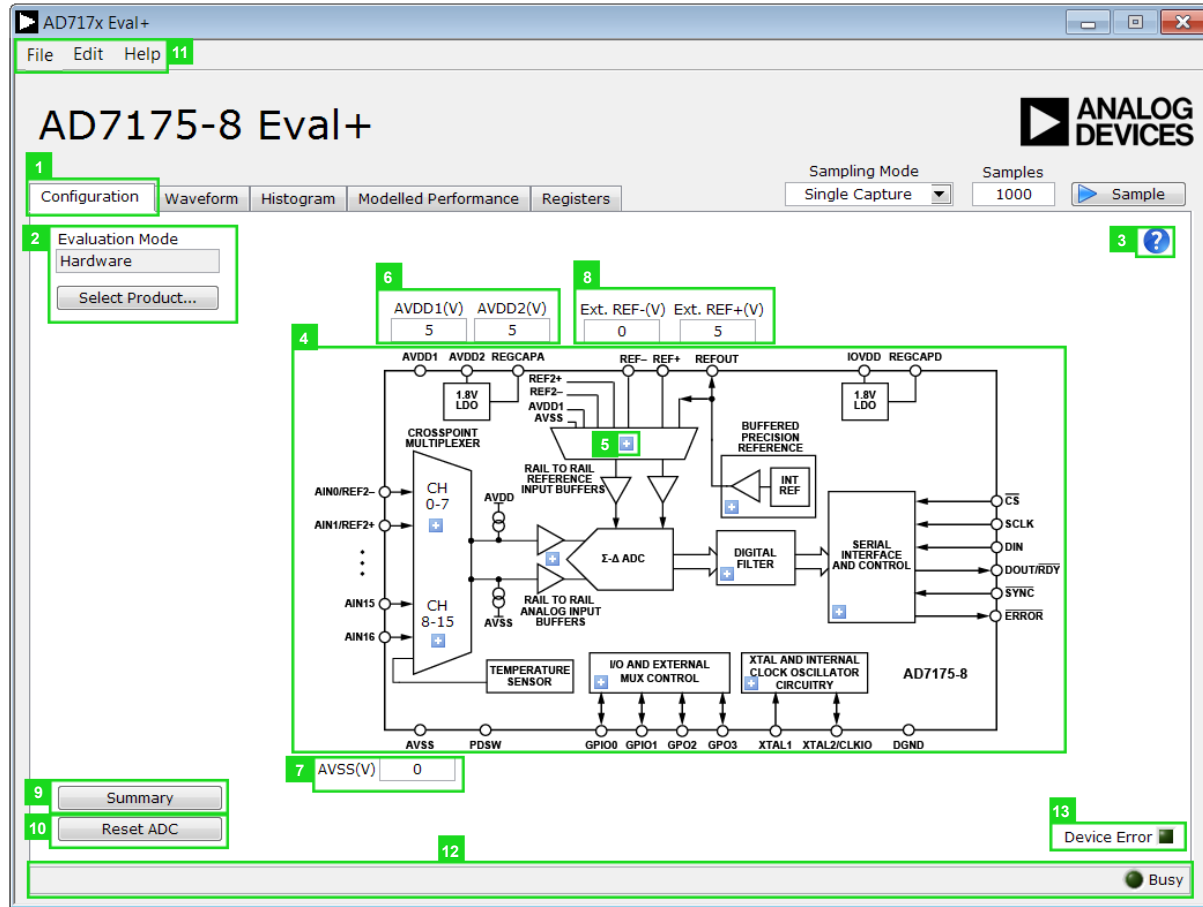

Figure 16. Configuration Tab of the AD7175-8 Eval+ Software in Hardware Mode

13767-116

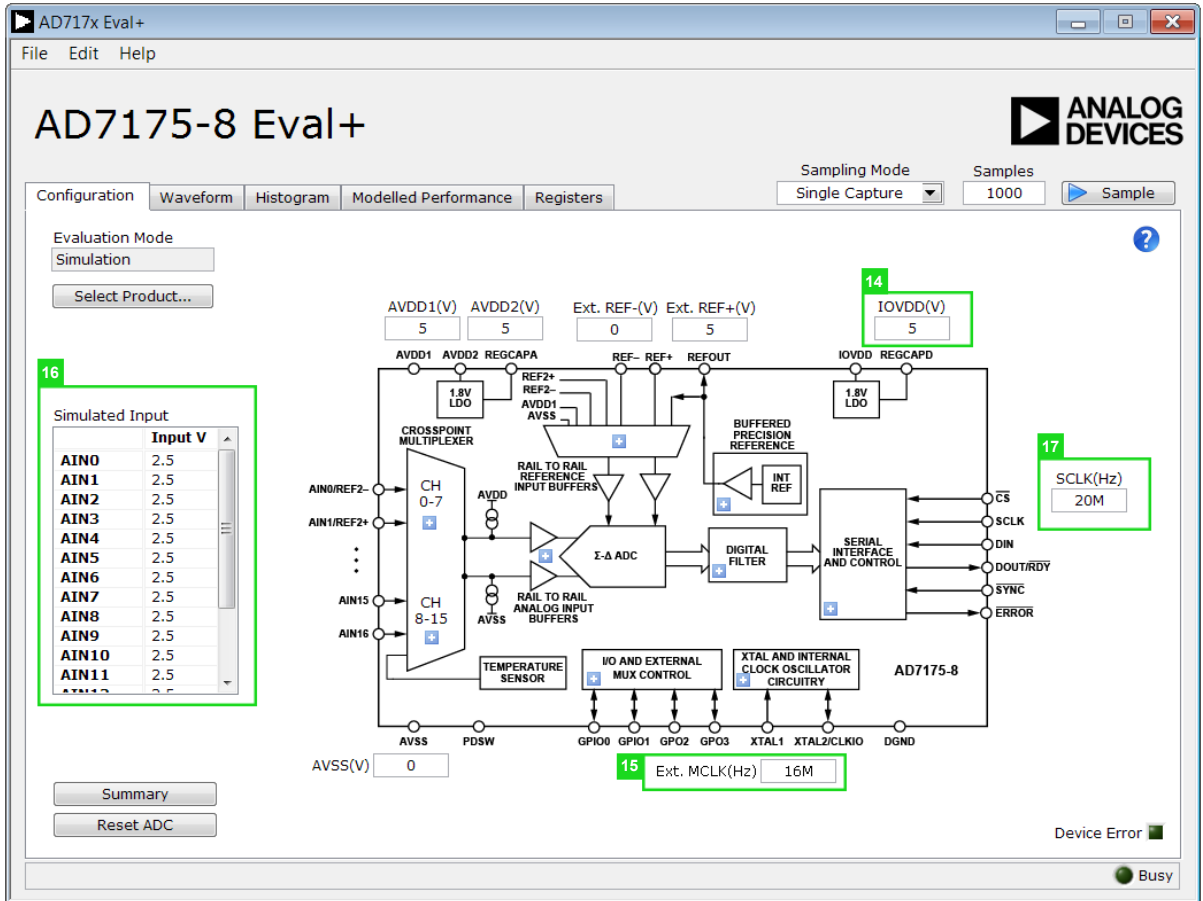

Figure 17. Configuration Tab of the AD7175-8 Eval+ Software in Simulation Mode

**OVERVIEW OF THE MAIN WINDOW**

The main window of the AD717x Eval+ software displays the significant control buttons and analysis indicators of the AD717x Eval+ software. The main window is divided into five tabs.

- Configuration
- Waveform
- Histogram
- Modelled Performance
- Registers

**CONFIGURATION TAB (1)**

Figure 16 shows the Configuration tab when Hardware Mode is selected and Figure 17 shows the Configuration tab when Simulation mode is selected. The controls highlighted in Figure 17 are only available in Simulation mode.

**Evaluation Mode (2)**

The Evaluation Mode indicator displays the current evaluation mode. To switch between modes, click the Select Product button and the dialog box shown in Figure 13 appears.

**Tutorial Button (3)**

Click the tutorial button to open a tutorial and access additional information on using the AD717x Eval+ software.

**Functional Block Diagram (4)**

The functional block diagram of the ADC shows each of the separate functional blocks within the ADC. Clicking a configuration pop-up button on any of the functional blocks opens the configuration pop-up window for the block selected. Not all blocks have a configuration button.

**Configuration Pop-up Button (5)**

Each configuration pop-up button opens a different window that allows the configuration of the relevant functional block.

**Analog and Digital Supply Voltage (6, 7, and 14)**

These input fields are used to take the supply voltage levels selected for the AD7175-8. Checks are performed to ensure the power supply voltage levels entered are within the specified limits. These power supply voltage levels are also used for the modelled performance to calculate the power dissipation.

**External Reference (Ext. REF) (8)**

The Ext. REF input fields set the positive and negative external reference voltage values. The difference is used for calculating the results for both the Waveform and Histogram tabs. The evaluation board has an external 5 V ADR445 reference, which can be bypassed by removing R32. Change the external reference values in Ext. REF to ensure correct calculation of results in the Waveform and Histogram tabs.

### **Register Configuration Summary(9)**

Click the **Summary** button to display the selected configuration of the [AD7175-8](#) this includes the channel configuration, information on each of the individual steps, and information on any error present.

### **Reset ADC (10)**

Click the **Reset ADC** button to perform a software reset of the [AD7175-8](#). The [AD7175-8](#) does not have a hardware reset pin, to perform a hard reset the power must be removed from the board. The software reset has the same effect as a hard reset.

### **Menu Bar (11)**

The menu bar has three section: **File**, **Edit**, and **Help**.

#### **File**

There are three options available in the **File** drop-down menu: Save, Load, and Generate.

#### **SAVE**

Save allows the user to save register configurations or waveform data. Register configurations can be saved as a JSON file or a header file. If the configuration is only used in the AD717x Eval+ software environment then it is recommended to use the JSON setting. Waveforms are saved as .csv files and the user is prompted to save the register configuration as well.

#### **LOAD**

Load allows the user to load saved register configurations or waveform data. In order to load a header into AD717x Eval+ it must be in the same format as one that is saved from AD717x Eval+. The header file can be used when developing firmware. When loading the waveform data the user is prompted to load the register configuration. This allows the software to correctly analyze the data.

#### **Edit**

There are two options in the **Edit** drop-down menu; Change Product Selection and Reset ADC. Change Product Selection

performs the same action as the **Select Product** button and Reset ADC performs the same action as the **Reset ADC** button.

#### **Help**

The **Help** drop-down menu provides links to extra information about the [AD7175-8](#), which includes links to the [AD7175-8](#) product page, [EVAL-AD7175-8SDZ](#) evaluation board user guide, [AD7175-8](#) datasheet, and No-OS Drivers. Selecting the AD717x Eval+ Tutorial opens the tutorial outlined in the Tutorial Button (3) section. For details on the current version of the software the **About** option opens a dialog box displaying the current version of the software and relevant licenses.

#### **Status Bar (12)**

The status bar displays the busy indicator and status updates, such as **Analysis Completed** and **Reset Completed** during software use.

#### **Device Error (13)**

The Device Error LED icon illuminates when an ADC error is detected or when a cyclic redundancy check (CRC) error occurs. The CRC functionality on the [AD7175-8](#) is disabled by default and must be enabled for the Device Error indicator to work. Specific information on the error can be found in the Register Configuration Summary(9) section.

#### **External MCLK Frequency (15)**

This field sets the external MCLK frequency. External MCLK Frequency (15)] is only visible on the front panel when an external clock source is selected by the ADC. It is used by the functional model for modelled performance.

#### **Analog Input Voltage (16)**

These fields are only available when simulation mode is selected. These inputs allow the analog input voltages to be set and can be changed at any time while in simulation mode.

#### **External SCLK Frequency (17)**

This input field sets the external SCLK frequency for the SPI interface. This field is only available in simulation mode to determine if the SCLK frequency is within the permitted range.

**WAVEFORM TAB (18)**

Figure 18 shows the **Waveform** tab of the AD717x Eval+Software.

**Sampling Mode (19)**

This control is unrelated to ADC mode. The user can capture a defined sample set, single capture; or continuously gather batches of samples, repeated capture. The user can also select data logging that runs similar to repeated capture, but posts the results to a .csv file. When saving, the .csv file prompts the user to save the register configuration. This is necessary to load the data back into the software for analysis.

**Samples (20)**

The Samples field control sets the number of samples gathered per batch. Single capture returns the number entered into the Samples control. Repeated capture keeps returning batches of the number entered into the Samples control until stopped by the user.

**Sample (21)**

Click the **Sample** button to start gathering ADC results. Results appear in the waveform graph (22). See Figure 18.

**Waveform Graph and Controls (22 and 23)**

The data waveform graph shows each successive sample of the ADC output. Zoom in on the data using the control toolbar (labeled 23 in Figure 18). Click the x-axis and y-axis to change the scales on the graph.

**Channel Selection (24)**

The channel selection control allows the user to choose which channels display on the data waveform graph (23). These controls only affect the display of the channels and have no effect on the channel settings in the ADC register map.

**Noise Analysis (25)**

The **Noise Analysis** section displays the results of the noise analysis for the selected analysis channel, which includes both noise and resolution measurements.

**Analysis Channel (26)**

The **Noise Analysis** section and histogram graph show the analysis of the channel selected via the **Analysis Control** drop-down menu.

**Display Units and Axis Controls (27)**

Click the **Display Units** drop-down menu to select the unit displayed in the graph. This control affects both the waveform graph and the histogram graph. The axis controls can be switched between dynamic and fixed. When dynamic is selected, the axis automatically adjusts to show the entire range of the ADC results after each batch of samples. When fixed is selected, the user can program the axis ranges; the axis ranges do not automatically adjust after each batch of samples.

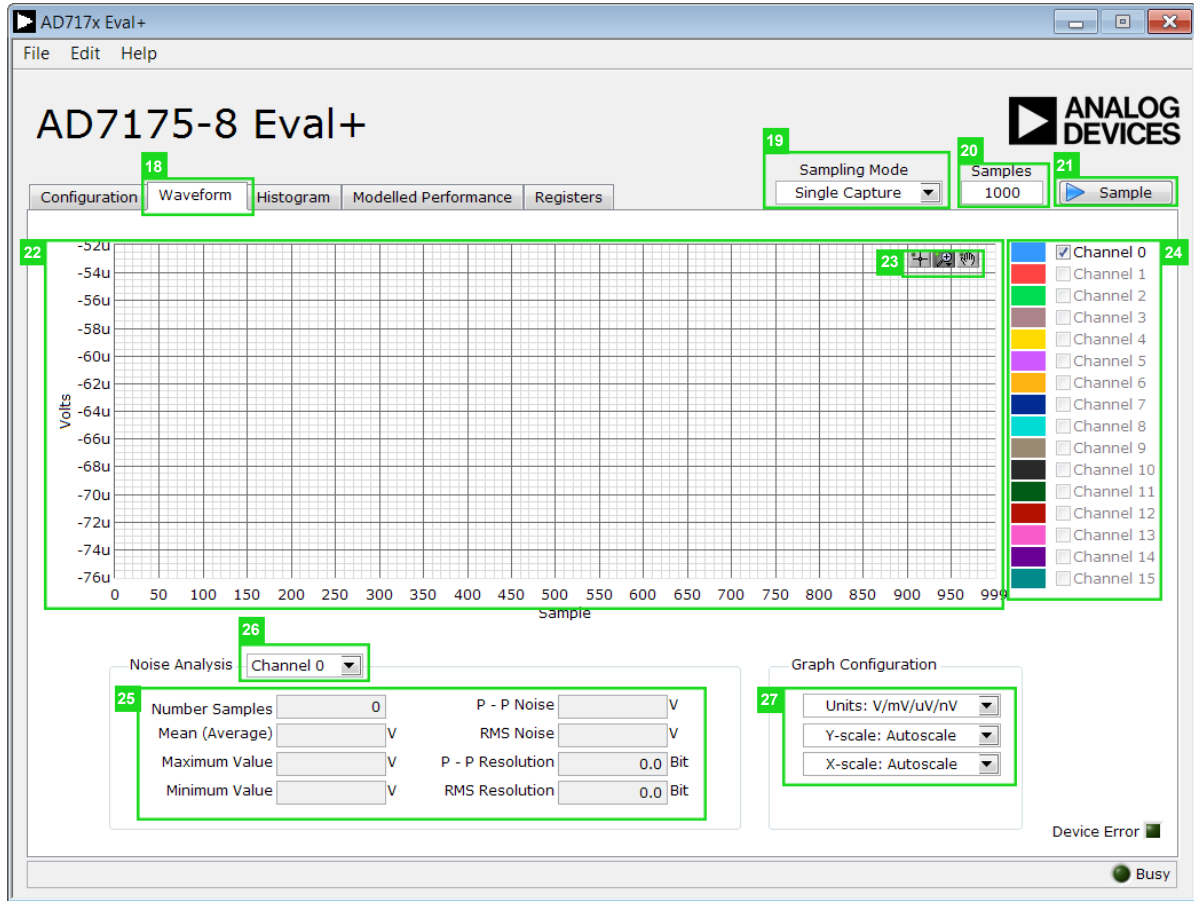

Figure 18. **Waveform** Tab of the [AD7175-8](#) Evaluation Software

13767-118

**HISTOGRAM TAB (28)**

Figure 19 shows the **Histogram** tab of the AD717x Eval+ Software.

**Histogram Graph and Controls (29 and 30)**

The data histogram graph (29) shows the number of times each sample of the ADC output occurs. The control toolbar (30) in the histogram graph allows the user to zoom in on the data (see Figure 19). Click the x-axis and y-axis to change the scales on the graph (see Figure 19).

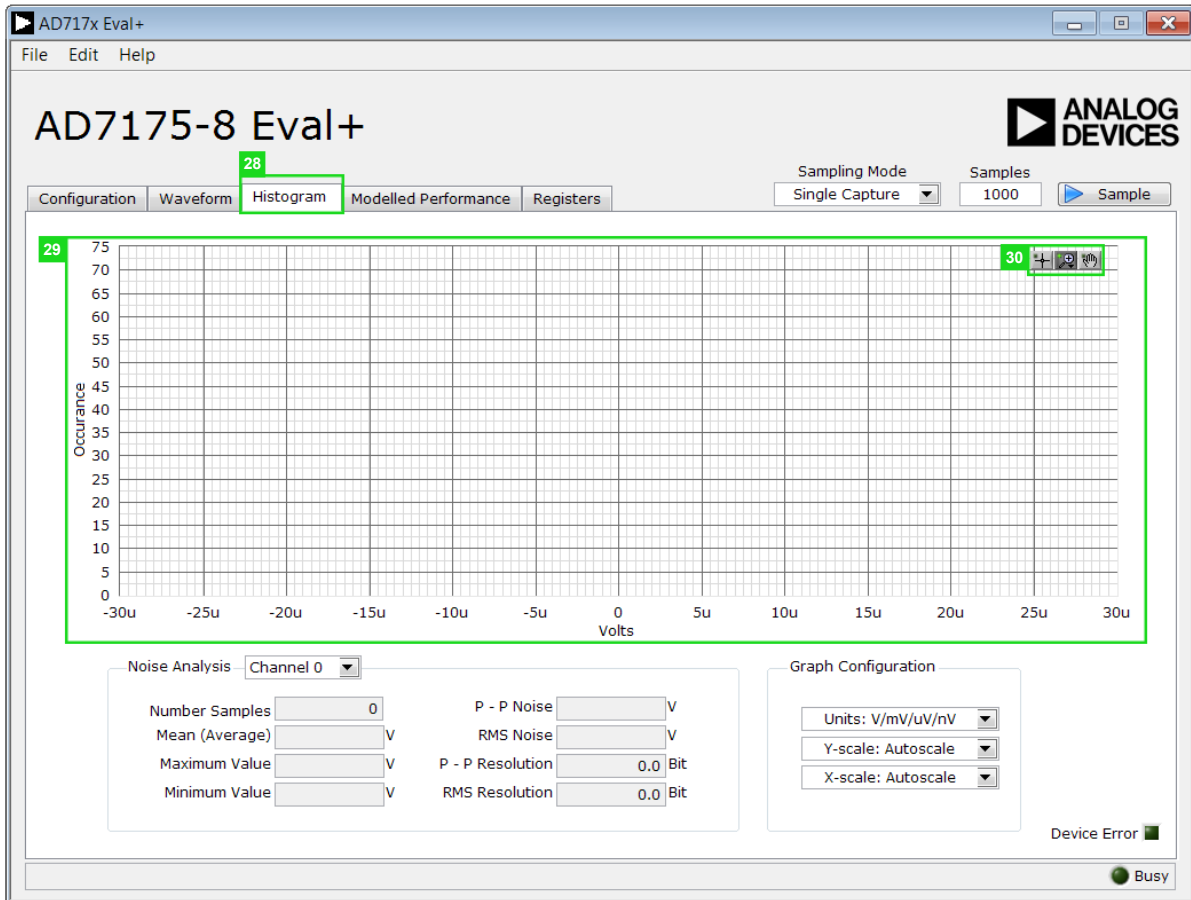

Figure 19. **Histogram** Tab of the AD7175-8 Eval+ Software

13767-119

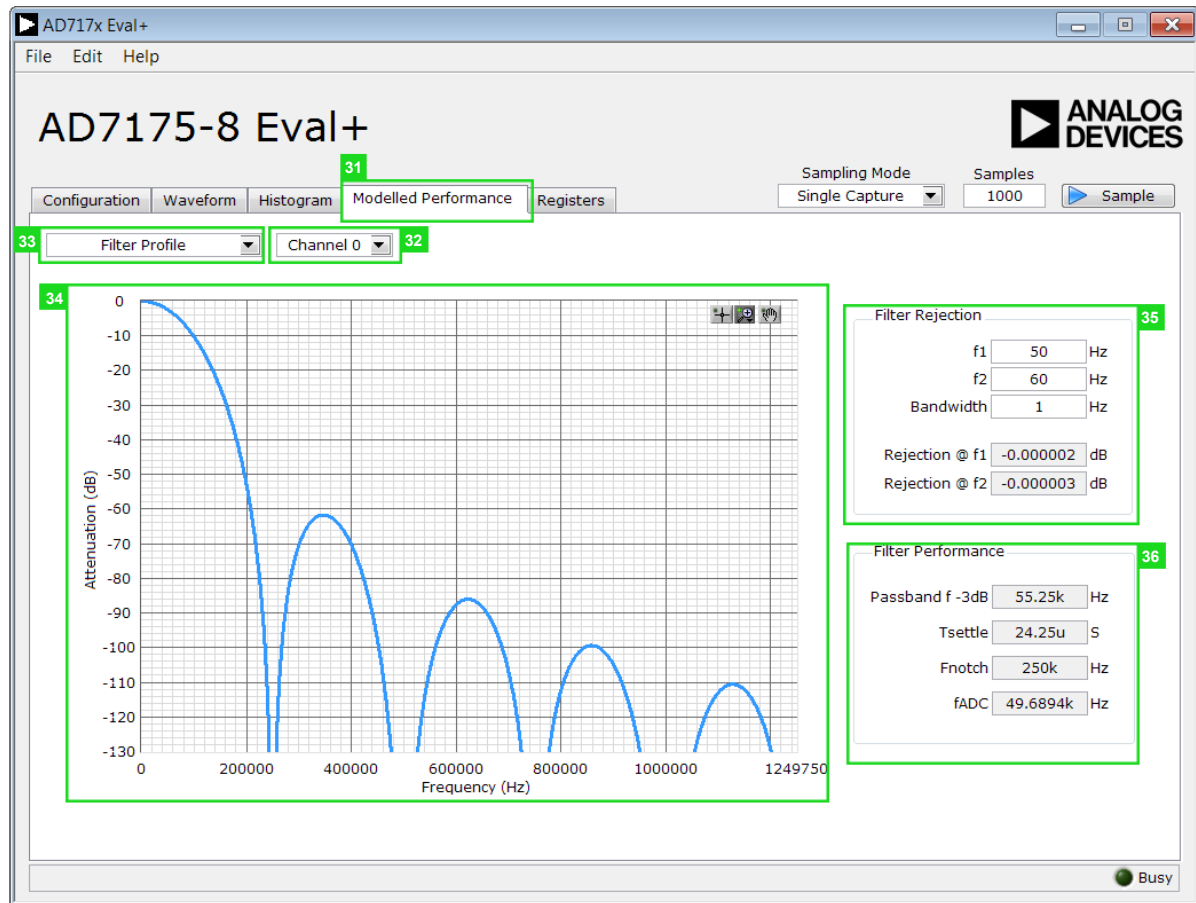

Figure 20. Filter Profiles of the AD7175-8 Evaluation Software

### MODELLED PERFORMANCE TAB (31)

The **Modelled Performance** tab shows a number of ADC performance parameters, which are calculated using the ADC functional model. There are three main sections to the **Modelled Performance** tab; Filter Profile, Filter Step Response, and Timing Diagram/Power. These can be selected using the drop-down menu (33).

#### Analysis Channel (32)

The **Analysis Channel** drop-down menu selects the channel to be evaluated by the functional model.

#### Filter Profile (33)

The **Filter Profile** drop-down menu allows the user to switch between the three sections of the **Modelled Performance** tab. Figure 20 shows the **Modelled Performance** tab when filter profile is selected.

#### Filter Profile Graph (34)

This graph shows the frequency response for the selected digital filter. The graph controls allow the user to zoom in on the data. Click the x-axis and y-axis to change the scales on the graph.

#### Filter Rejection (35)

This section shows the rejection/attenuation of the digital filter over the rejection bandwidth (Rej.BW) for  $f_1$  and  $f_2$  in decibels;  $f_1$ ,  $f_2$ , and Bandwidth can be changed.

#### Filter Performance (36)

This section shows the timing information about the data rate of the selected output. It shows the ADC initial settling time (**Tsettle**), the first frequency notch (**Fnotch**), and the actual sampling frequency (**fADC**).



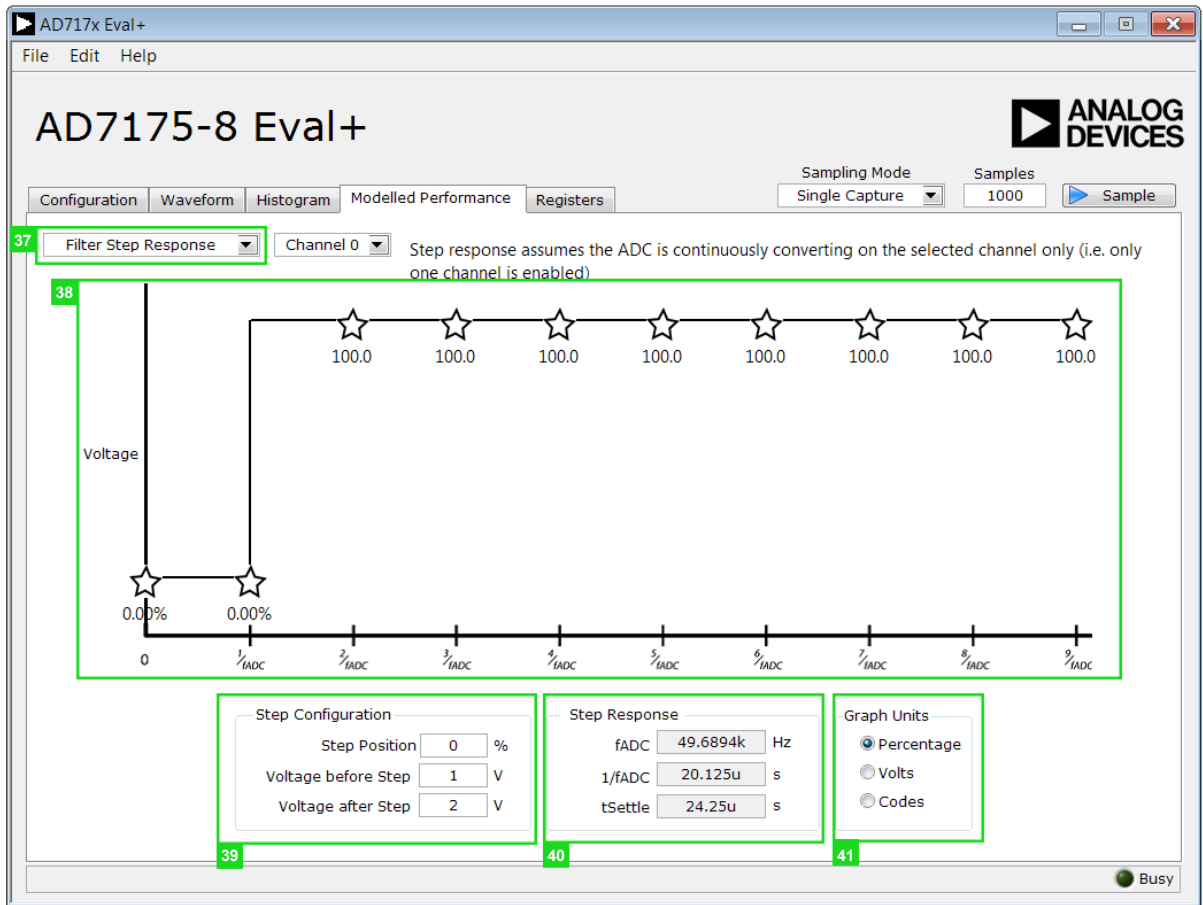

Figure 21. Filter Step Response of the AD7175-8 Evaluation Software

**Filter Step Response (37)**

This drop down menu allows the user to switch between the three sections of the **Modelled Performance** tab. Figure 21 shows the tab when Filter Step Response is selected.

**Step Response Graph (38)**

This graph shows how long the filter takes to settle when the voltage is stepped from one voltage to the next. For this analysis, it is assumed the ADC is continuously converting on only one channel.

**Step Configuration (39)**

Step Configuration allows the user to set the voltage before and after the step and the step position. Step position is set as a percentage where 0% is 1/fADC and 100% is 2/fADC.

**Step Response (40)**

This section shows timing information about the data rate of the selected output. It shows fADC, Tsettle, and the settling time between conversions, 1/fADC.

**Graph Units (41)**

Use this control to switch the step response between percentages, volts, and codes.

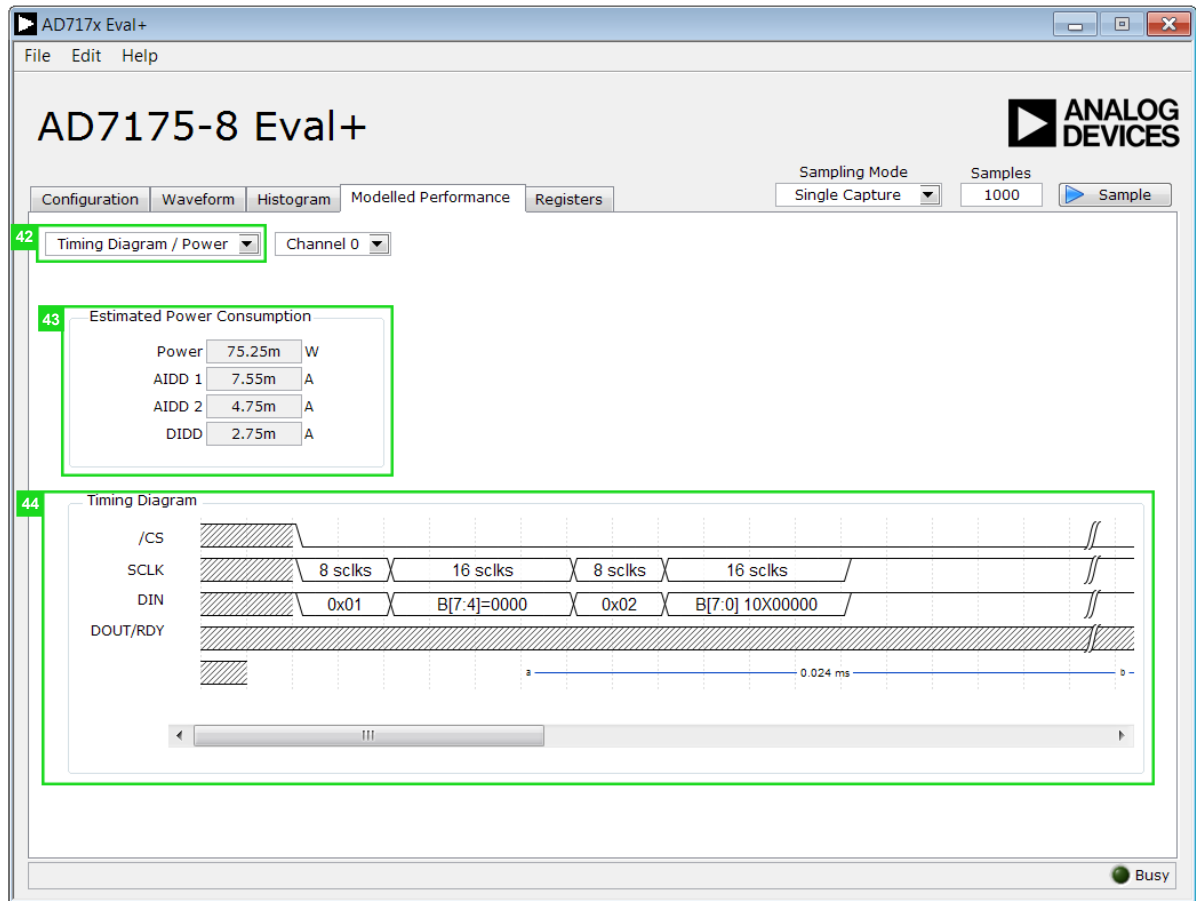

Figure 22. Timing Diagram/Power of the AD7175-8 Evaluation Software

#### Timing Diagram/ Power (42)

This drop down menu allows the user to switch between the three sections of the **Modelled Performance** tab. Figure 22 shows the **Modelled Performance** tab when Filter Step Response is selected.

#### Estimated Power Consumption (43)

This section shows the total power consumption of the device in the current configuration, as well as, the current consumption on each of the power supply rails. Note that the estimated power consumption is for the continuous conversion mode only and no other mode of operation is supported.

#### Timing Diagram (44)

This graph shows the digital interface timing diagram for the current configuration. The graph shows the timing for both the configuration of the ADC, and the subsequent data reads from the ADC.

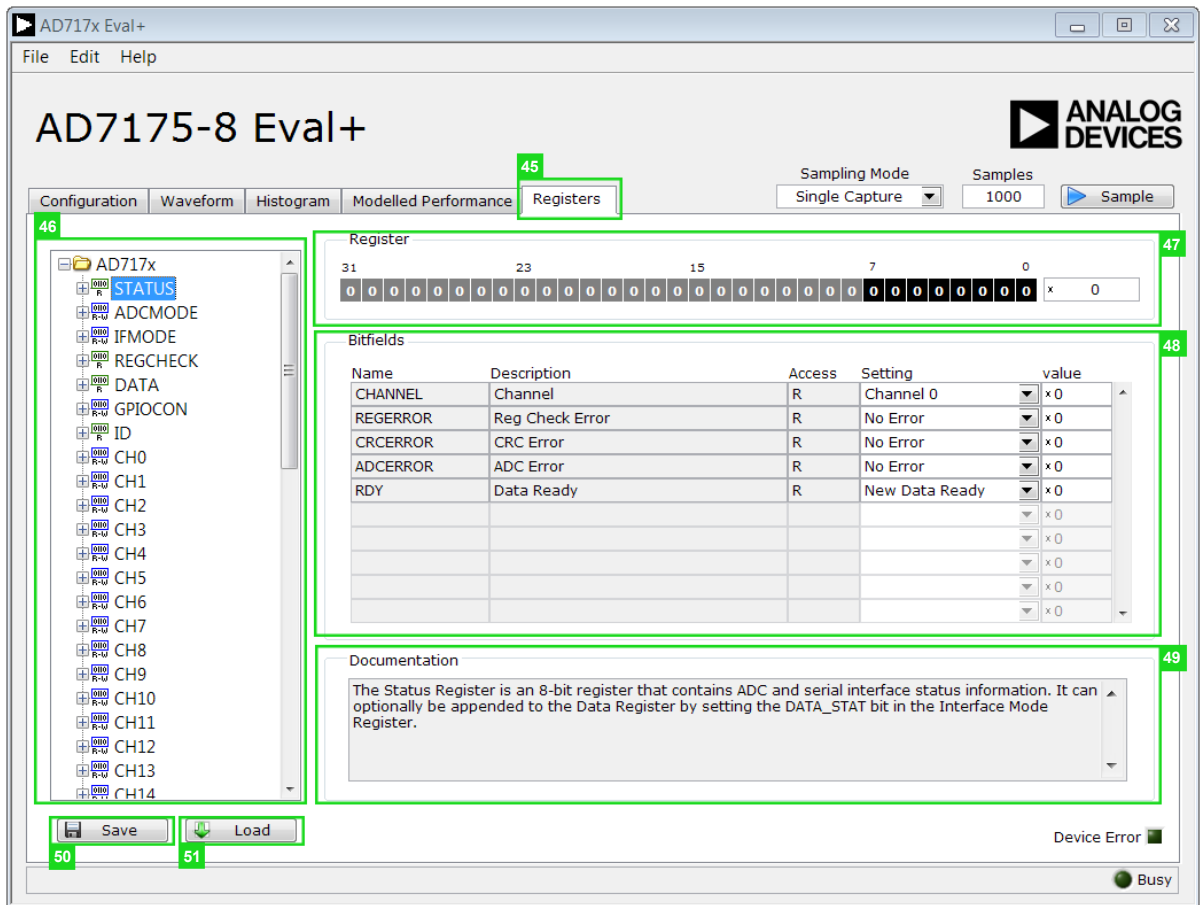

Figure 23. Registers Tab of the AD7175-8 Evaluation Software

**REGISTERS TAB (45)**

Figure 23 shows the Registers tab.

**Register Tree (46)**

This control shows the full register map in a tree control. Each register is shown; click the expand button next to each register to show all the bit fields contained within that register.

**Register (47)**

The Register control allows the user to change the individual bit of the register selected in the register tree (46) by clicking the bits or by programming the register value directly into the number control field on the right.

**Bitfields (48)**

This list shows all the bit fields of the register selected in the register tree (46). Change the values by using the drop-down box or by directly entering a value into the number control field on the right.

**Documentation (49)**

The Documentation field contains the documentation for the register or bitfield selected in the register tree (46).

**Save(50) and Load (51)**

The Save (50) and Load (51) buttons allow the user to save the current configuration of the AD7175-2 by saving off of the register map setting to a file and load the setting from that same file. When using these buttons the register configurations are saved and loaded as JSON files.

**EXITING THE SOFTWARE**

To exit the software, click the close button at the top right corner of the main window (see Figure 16).

EVALUATION BOARD SCHEMATICS AND ARTWORK

131797-124

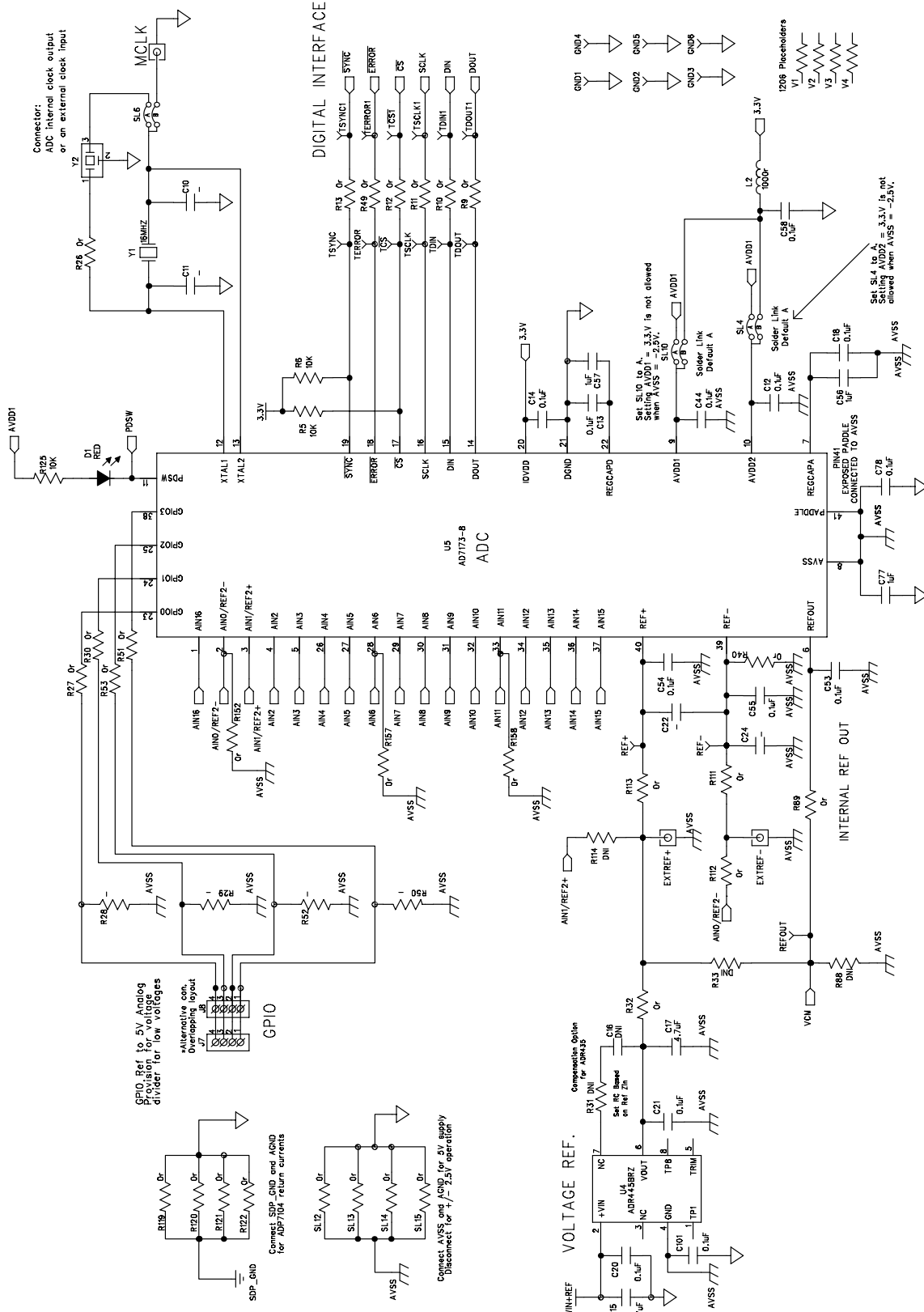

Figure 24. AD7175-8 Schematic

13767-124

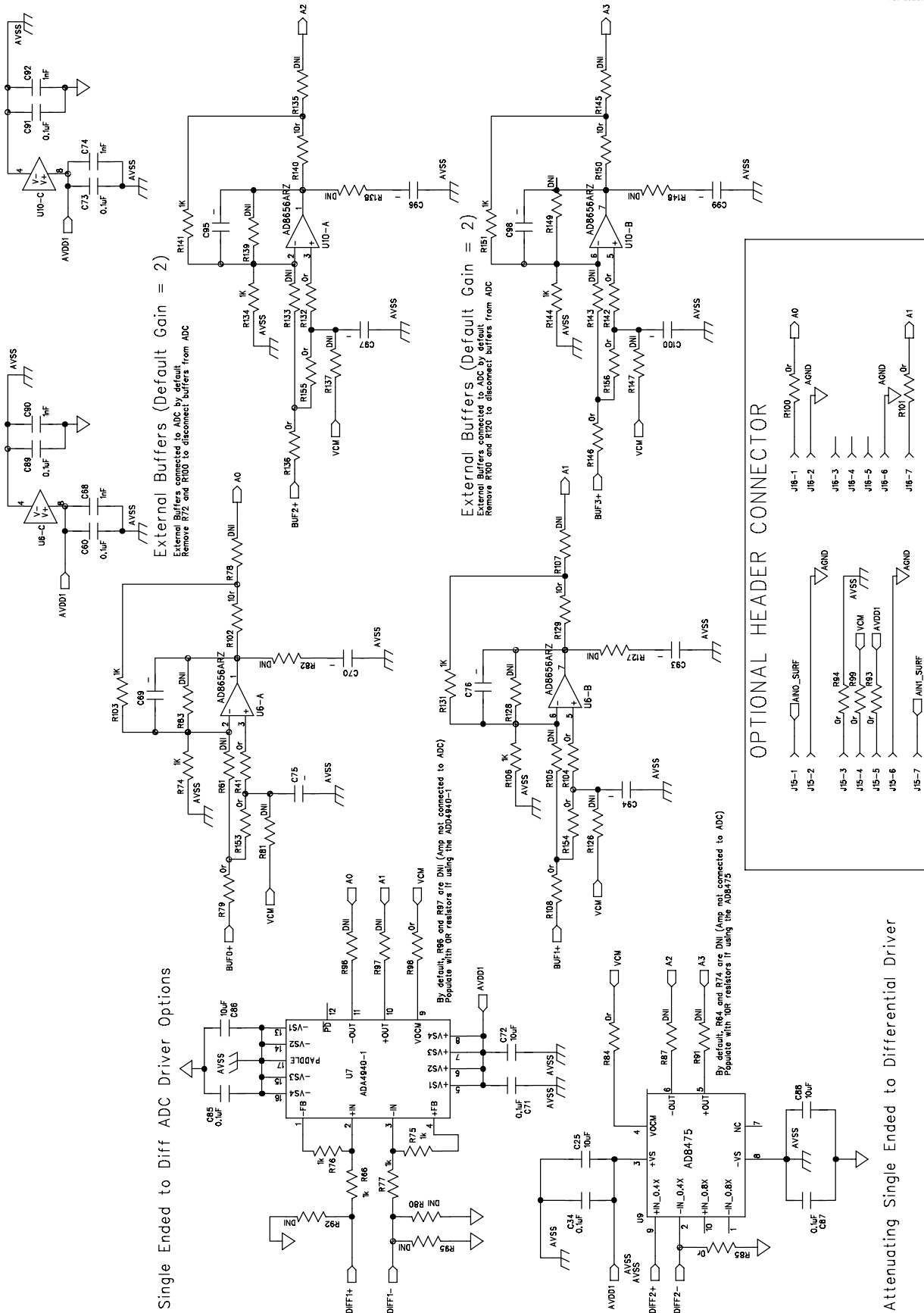

Figure 25. Amplifier Schematic  
Rev. A | Page 21 of 33

Attenuating Single Ended to Differential Driver

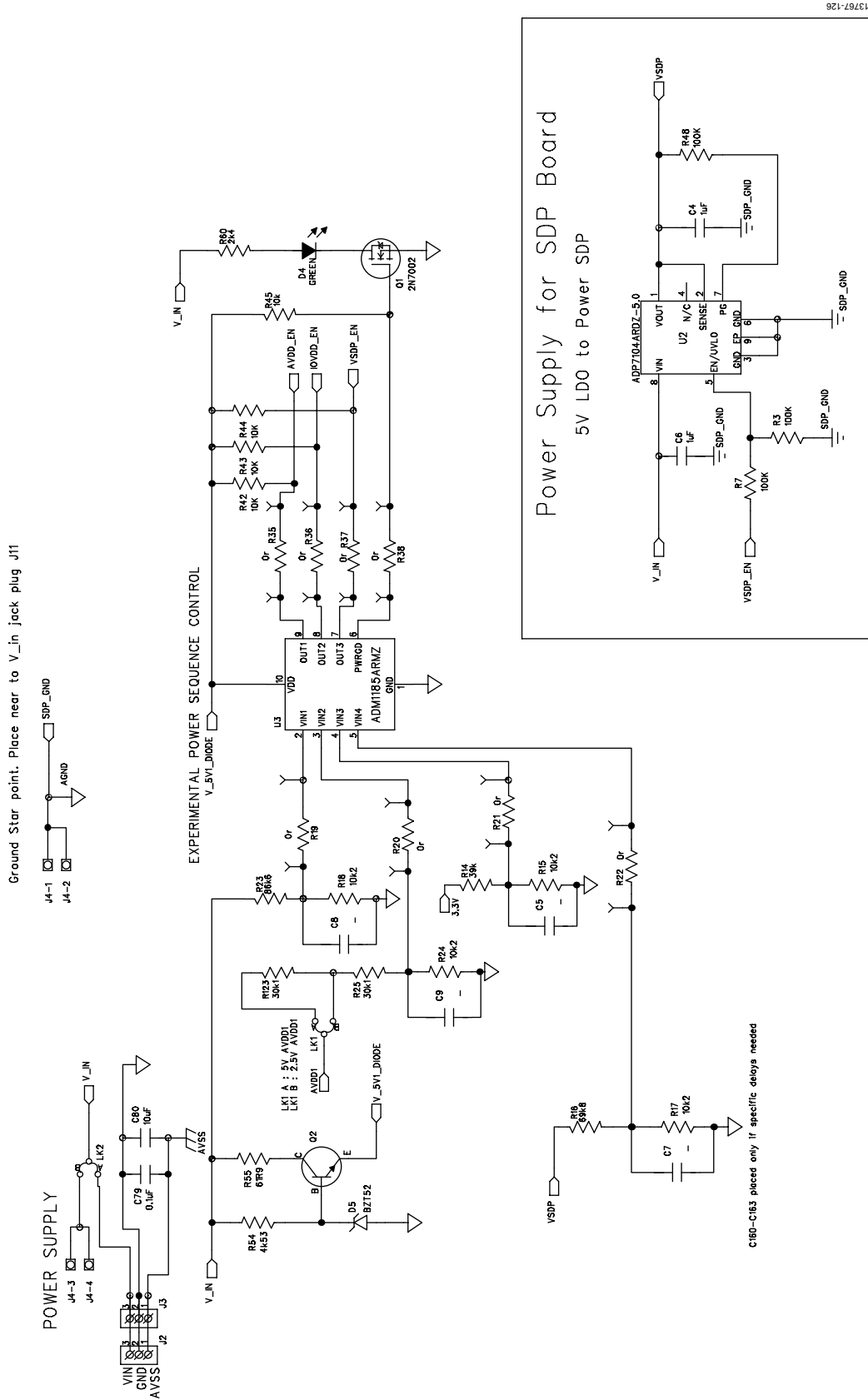

Figure 26. Power Supply Sequencing Schematic

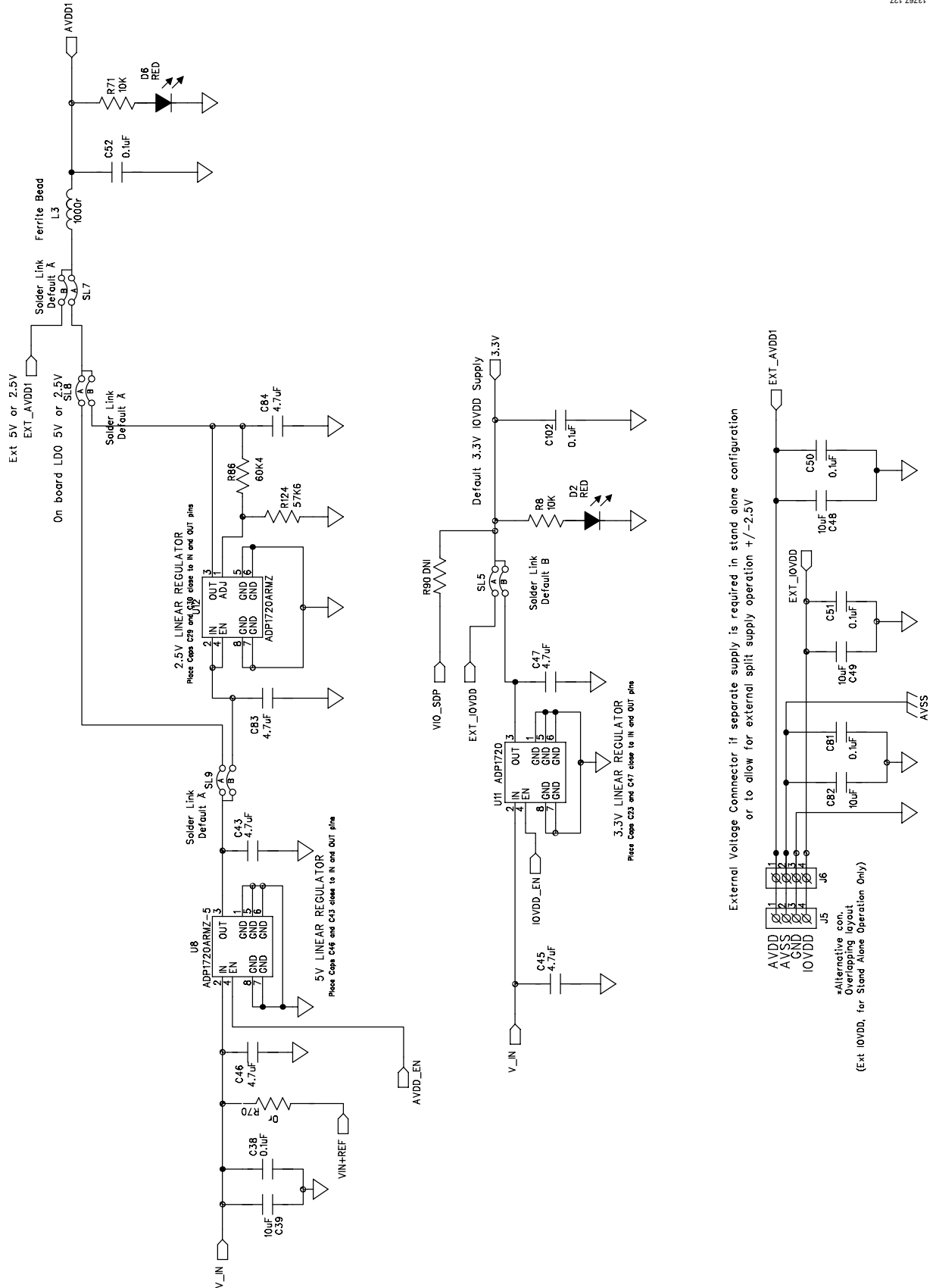

Figure 27. Regulator Schematic

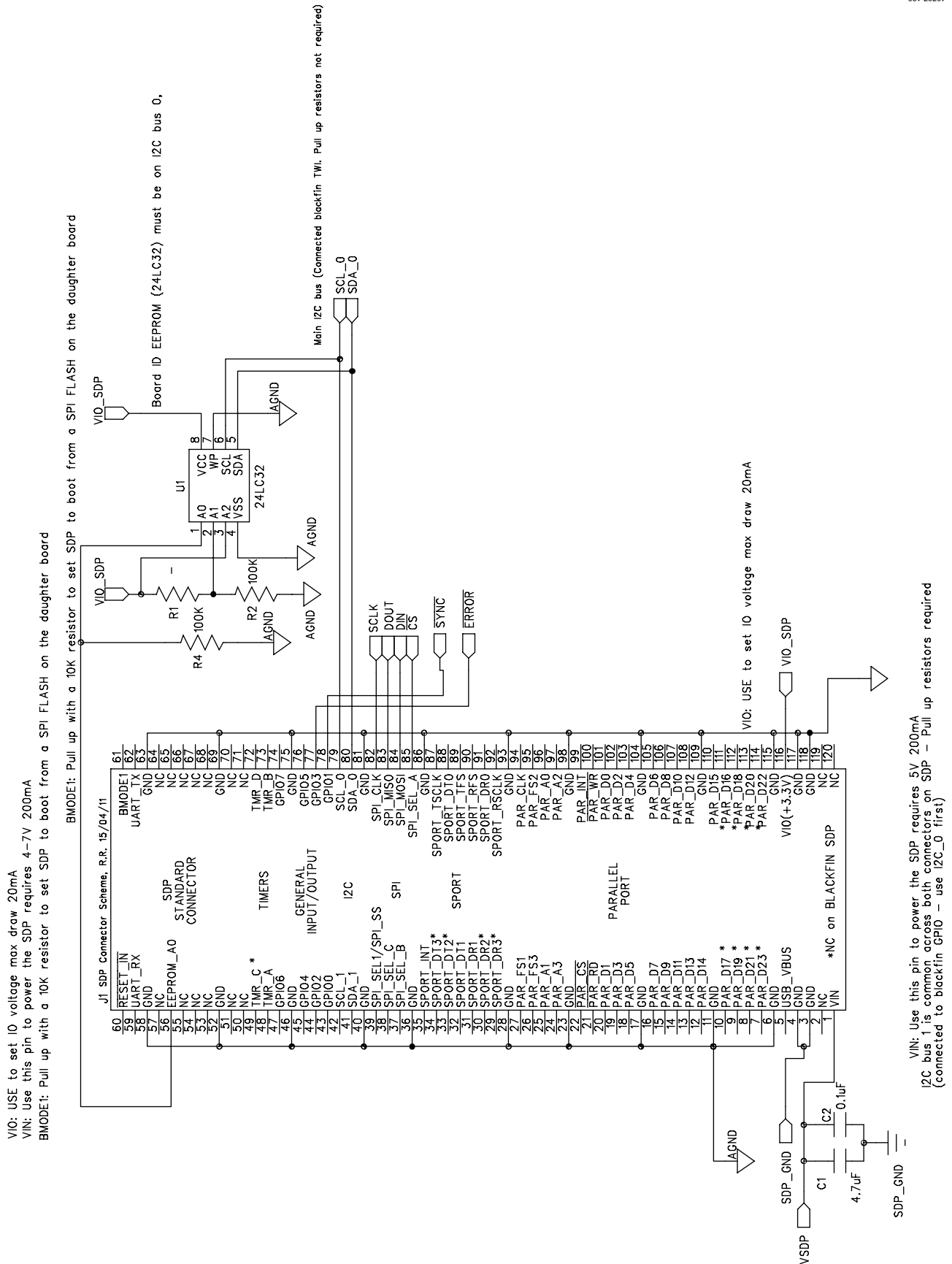
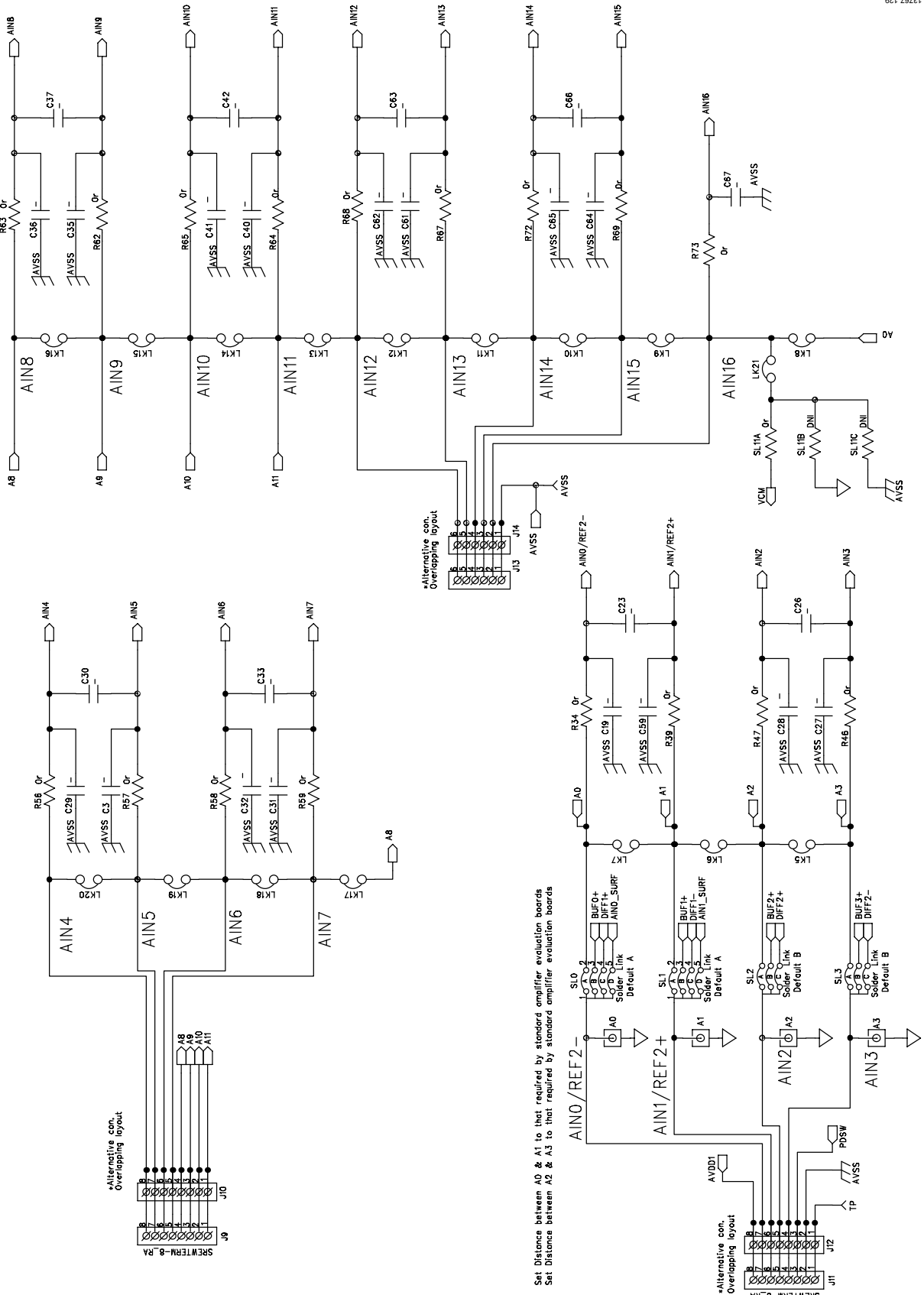

Figure 28. SDB-B Connector Schematic  
 Rev. A | Page 24 of 33



13767-129



Set Distance between A0 & A1 to that required by standard amplifier evaluation boards  
Set Distance between A2 & A3 to that required by standard amplifier evaluation boards

Figure 29. Analog Inputs Schematic

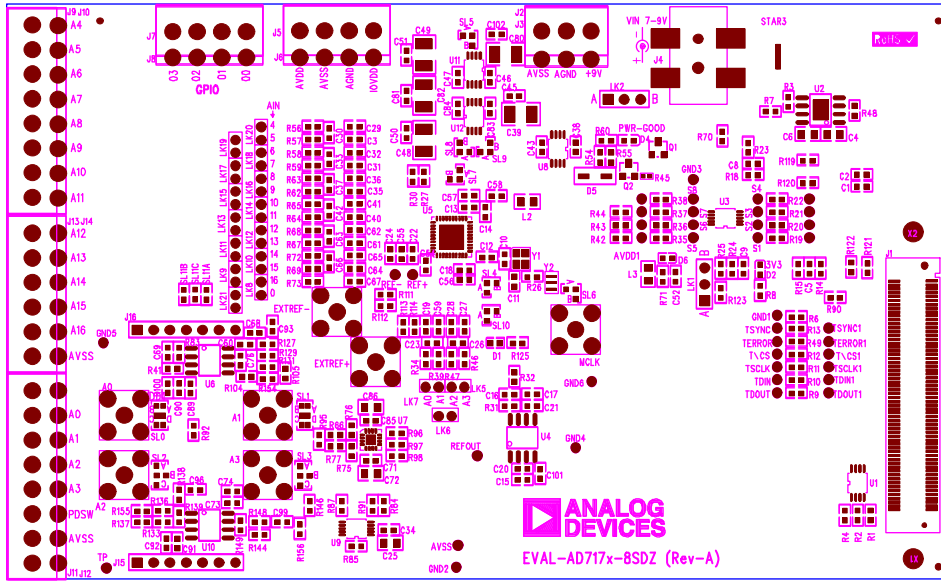

Figure 29. Top Printed Circuit Board (PCB) Silkscreen

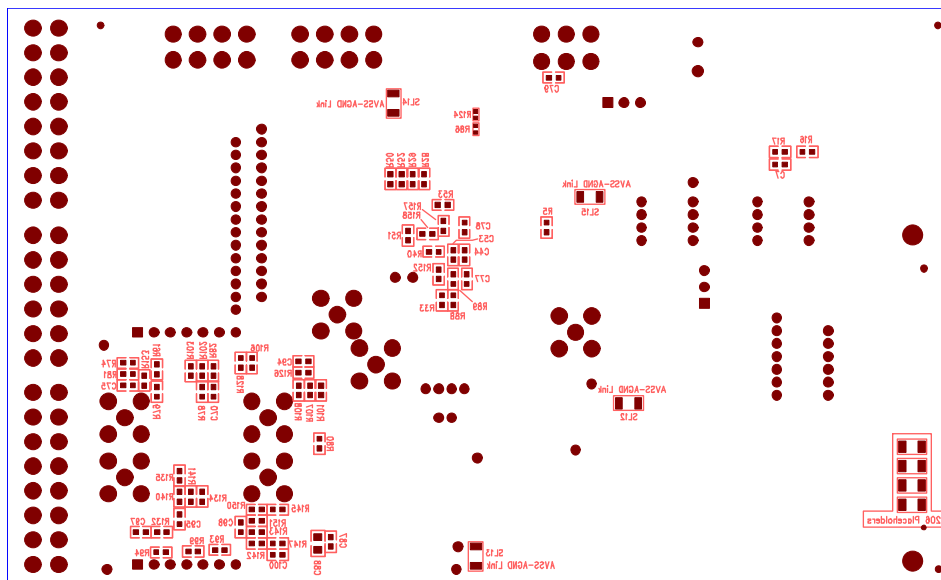

Figure 30. Bottom PCB Silkscreen

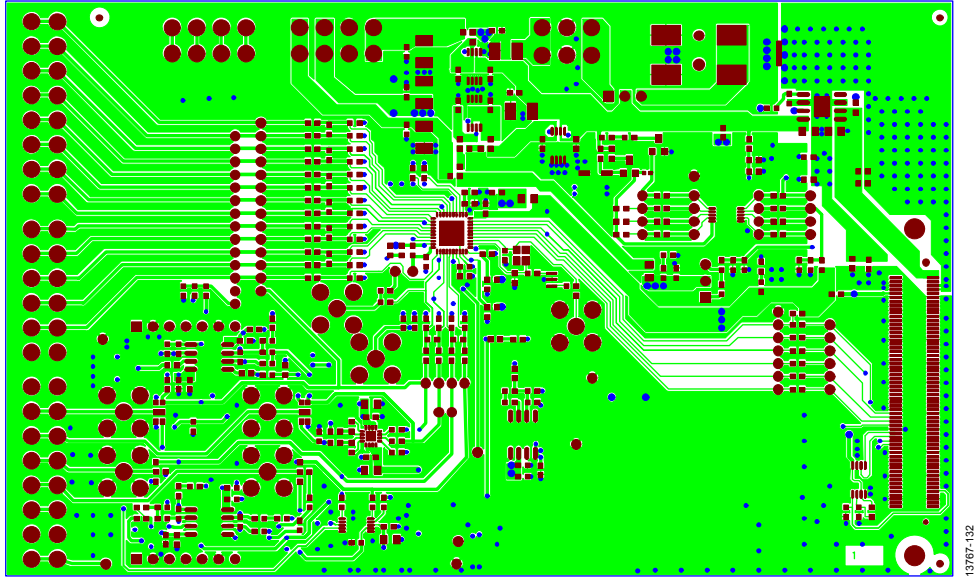

Figure 31. Layer 1 Component Side

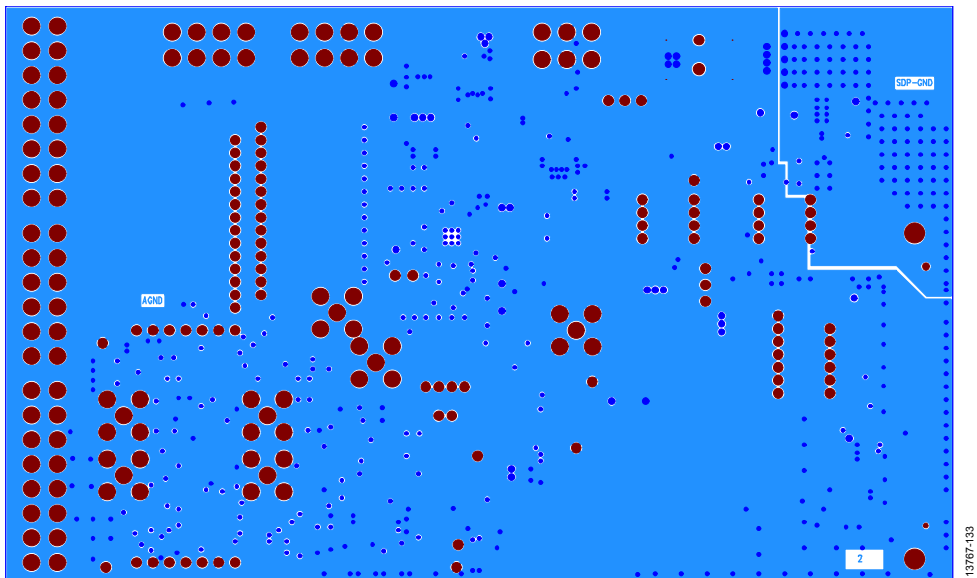

Figure 32. Layer 2 Ground Plane

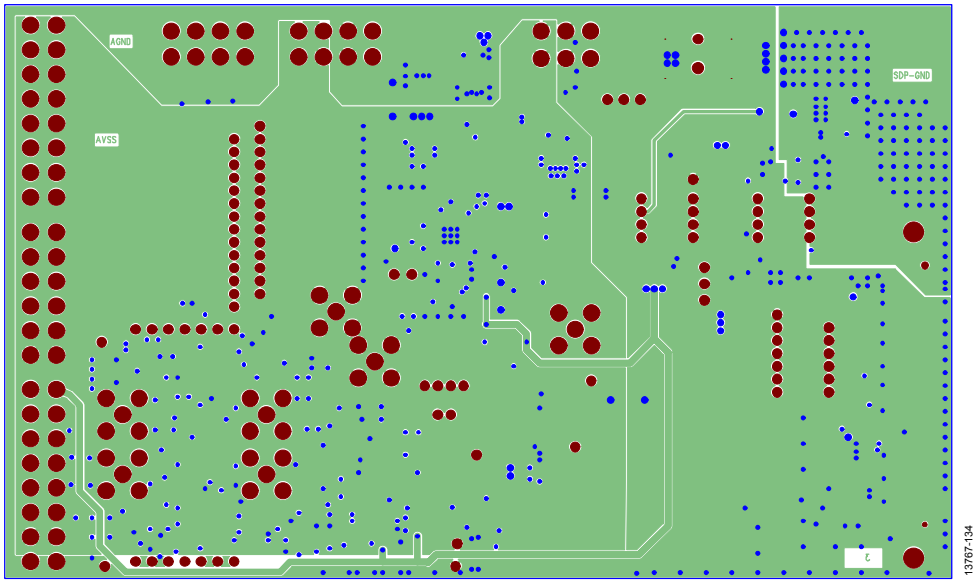

Figure 33. Layer 3 Power/Ground Plane

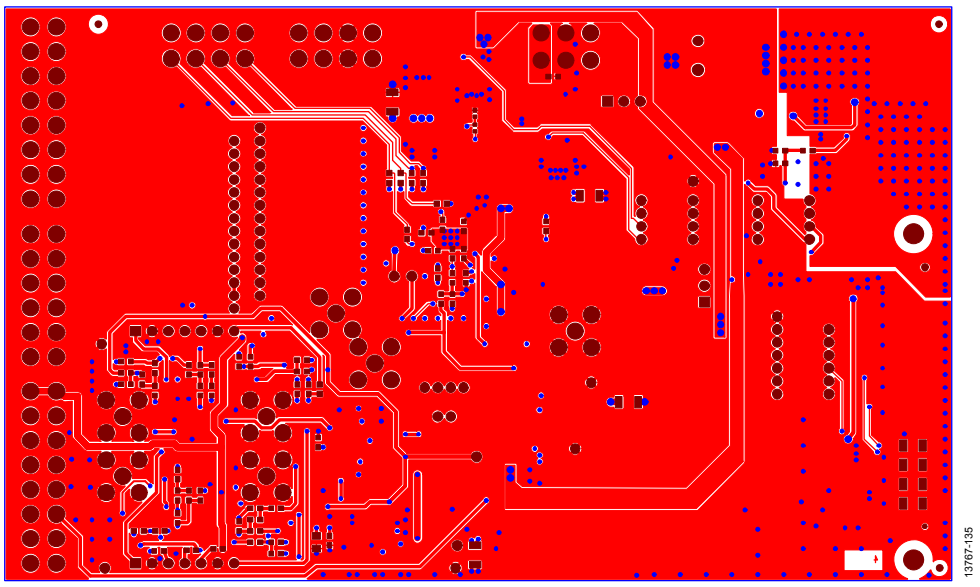

Figure 34. Layer 4 Solder Side

## ORDERING INFORMATION

### BILL OF MATERIALS

Name	Part Description	Manufacturer	Part Number	Stock Code
A0 through A3, EXTREF+, EXTREF-, MCLK	Straight PCB mount SMB jack, keep hole clear of solder. Do not insert.	TE Connectivity	1-1337482-0	Do not insert
C1, C17, C43, C47, C83 through C84	Ceramic capacitor, 6.3 V, X5R, 0603, 4.7 µF	Murata	GRM188R60J475K	FEC 173-5527
C2, C12 through C14, C18, C20 through C21, C34, C38, C44, C50 through C55, C58, C60, C71, C73, C78 through C79, C81, C85, C87, C89, C91, C101 through C102	Capacitor, 0603, 0.1 µF, 16 V	Multicomp	B0603R104KCT	FEC 940-6140
C15, C45 through C46	Ceramic capacitor, 10 V, X5R, 0603, 4.7 µF	KEMET Electronics Corp.	C0603C475K8PACTU	FEC 157-2625
C3, C5, C7 through C9, C19, C22 through C24, C26 through C33, C35 through C37, C40 through C42, C59, C61 through C67	Ceramic capacitor, not inserted, 0402	Not applicable	Not applicable	Do not insert
C69 through C70, C75 through C76, C93 through C100	Ceramic capacitor, not inserted, 0603	Not applicable	Not applicable	Do not insert
C10 through C11	Capacitor, 0603, 1 µF, 6.3 V	Not applicable	Not applicable	Do not insert
C4, C6	Capacitor, 0805, 50 V, X7R, 1 µF	Murata	GRM21BR71H105KA12L	FEC 1735541
C56 through C57, C77	Capacitor, 0603, 1 µF, 6.3V	Murata	GRM188R70J105KA01D	FEC 184-5765
C16	Ceramic capacitor, not inserted, 0402	Not applicable	Not applicable	Do not insert
C25, C72, C86, C88	Ceramic capacitor, 10 µF, 16 V, X5R, 0805	Murata	GRM21BR61C106KE15L	490-3886-1-ND
C39, C48 through C49, C80, C82 C68, C74, C90, C92	Ceramic capacitor, 50 V, X5R, 1210 Multilayer ceramic capacitor, 50 V, X7R	Murata Yageo	GRM32ER61H106K 2238 586 15623	FEC 184-5764 FEC 722170
D1 through D2, D6	Red LED, high intensity (>90 mCd), 0603	Broadcom Ltd.	HSMC-C191	FEC 855-4528
D4	LED, SMD green	Osram	LGQ971	FEC 1226372
D5	Zener Diode, 0.5 W, 5.1 V	Vishay	BZT52B5V1-V-GS08	FEC 1617767
AVSS, GND1 through GND6, REF+, REF-, REFOUT, S1 through S8, S1' through S8', TDIN, TDIN1, TDOUT, TDOUT1, TERROR, TERROR1, TP, TSCLK, TSCLK1, TSYNC, TSYNC1, TVCS, TVCS1	Test point, not inserted, keep hole clear of solder	Not applicable	Not applicable	Do not insert
J1	120-way connector, 0.6 mm pitch	HIROSE	FX8-120S-SV(21)	FEC 1324660
J2	PC-SCREWTERM-3WAY	Phoenix Contact	1727023	Do not insert
J3	Socket terminal block, 3.81 mm pitch	Phoenix Contact	MC 1.5/3-G-3.81	FEC 370-4737
J4	CON\BARREL_SMD_2MM_KLDX-SMT2-0202-A	Mouser	KLDX-SMT2-0202-A	806-KLDX-SMT20202A
J5	SCREWTERM-4	Phoenix Contact	MKDS1/4-3.81	FEC 370-4592
J6	POWER_SKT_3.81MM_4WAY, keep clear of solder	Phoenix Contact	MC1.5/4-G-3.81	Do not insert
J7	SCREWTERM-4, keep clear of solder	Phoenix Contact	MKDS1/4-3.81	Do not insert
J8	POWER_SKT_3.81MM_4WAY	Phoenix Contact	MC1.5/4-G-3.81	FEC 370-4749 and FEC 370-4920

Name	Part Description	Manufacturer	Part Number	Stock Code
J9	SCREWTERM-8_RA, keep clear of solder	Phoenix Contact	1727078	Do not insert
J10	POWER_SKT_3.81MM_8WAY	Phoenix Contact	MC 1,5/ 8-G-3,81	FEC 370-4774 and FEC 370-4956
J11	SCREWTERM-8_RA, keep clear of solder	Phoenix Contact	1727078	Do not insert
J12	POWER_SKT_3.81MM_8WAY	Phoenix Contact	MC 1,5/ 8-G-3,81	FEC 370-4774 and FEC 370-4956
J13	SCREWTERM-6-RA, keep clear of solder	Phoenix Contact	MKDS1/6-3.81	Do not insert
J14	POWER-SKT-3.81MM_6WAY	Phoenix Contact	MC 1,5/ 6-G-3,81	FEC 370-4762 and FEC 370-4944
J15	CON\7HEADER	Samtec	SSW-107-01-T-S	FEC 1803478
J16	CON\7HEADER	Samtec	TLW-107-05-G-S	FEC 1668499
L1 through L4	Ferrite bead, 0.3 $\Omega$ at dc, 1000 $\Omega$ at 100 MHz, 350 mA, 0805	TE Connectivity	BMB2A1000LN2	FEC 119-3421
LK1 through LK2	3-pin (3 $\times$ 1) 0.1" header and shorting block in A	Harwin	M20-9990346 and M7566-05	FEC 1022249 and FEC 150-411
LK5 through LK21	2-pin (2 mm Pitch) header and shorting shunt	Harwin	M22-2010205 and M22-1920005	FEC 671915 and FEC 510944
Q1	SI2304DDS-T1-GE3	Fairchild Semiconductor	2N7002	FEC 1853257
Q2	NPN-BCX19, SOT23	ON Semiconductor	MMBT3904LT1G	FEC 1459100
R1	Resistor, not inserted, 0603	Multicomp	MC 0.063W 0603 0R	Do not insert
R28, R29, R50, R52	Resistor, not inserted, 0402	N/A	N/A	Do not insert
R2 through R4, R7, R48	Resistor, 100 K, 0.063 W, 1%, 0603	Multicomp	MC 0.063W 0603 1% 100 K	FEC 9330402
R5, R6, R8, R42 through R44, R71, R125	Resistor, 1 %, 0603	Multicomp	MC 0.063W 0603 1% 10 K	FEC 933-0399
R45	Resistor, thick film, 10 k $\Omega$ , 62.5 mW, 5 %	Yageo	RC0402JR-1310KL	FEC 179-9316
R9 through R13, R19 through R22, R26 through R27, R30, R32, R34 through R41, R46 through R49, R51, R53, R56 through R59, R62 through R70, R72, R73, R79, R85 through R85, R89, R93, R94, R98 through R101, R104, R108, R111, R113, R119 through R122, R132, R136, R142, R146, R153 through R156	Resistor, 0603, 1 %, 0R	Vishay	CRCW06030000Z0EA	FEC 146-9739
R33, R90, R112, R114	Resistor, 0402	Vishay		Do not insert
R61, R81 through R83, R87, R91 through R92, R95 through R97, R105, R126, R127 through R128, R133, R137 through R139, R143, R147 through R149, R152, R157, R158	Resistor, 0603, 1 %, 0R	Vishay	CRCW06030000Z0EA	Do not insert
R14	Resistor, 0402, 1 %, 39 K	Multicomp	MC 0.063W 0603 1% 39K	FEC 9331158
R15, R17, R18, R24	Resistor, 0603 10 k2 1 %	Vishay	CRCW060310K2FKEA	FEC 1652829
R25, R123	Resistor, 0603, 1 %, 30 k1	Vishay	CRCW060330K1FKEA	FEC 1469798
R80	Resistor, 0603, thick film, 1 %	Vishay	CRCW06031K00FKEA	Do not insert.

Name	Part Description	Manufacturer	Part Number	Stock Code
R31, R78, R88, R107, R135, R145	SMD Resistor, 0603	Not applicable	Not applicable	Do not insert
R54	Resistor, thick film, 4.53 k $\Omega$ , 63 mW, 1 %	Vishay	CRCW06034K53FKEA	FEC 2138399
R55	Resistor, 0603, 1 %, 61R9	Vishay	CRCW060361R9FKEA	FEC 2141253
R60	Resistor, thick film, 2.4 k $\Omega$ , 0603, 100 mW, 1 %	Yageo	RC0603FR-072K4L	FEC 1799329
R66, R75 through R77	Resistor, 0603, thick film, 1 %	Vishay	CRCW06031K00FKEA	FEC 1469740
R74, R103, R106, R131, R134, R141, R144, R151	Resistor, 0603, 1 K	Panasonic	ERA3AEB102V	FEC 1577605
R86	Resistor, 0402, 60 K4	Multicomp	MC 0.0625W 0402 1 % 60K4	FEC 1803729
R102, R129, R140, R150	Resistor, 0603, 10R	Bourns Inc.	CR0603-FX-10R0GLF	FEC 2008331
SL0, SL1	4-way Solder Link (Use Or 0603 Resistor)	Not applicable	Insert in Link Position "A"	FEC 933-1662
SL2, SL3	2-way Solder Link (Use Or 0603 Resistor)	Not applicable	Insert in Link Position "A"	FEC 933-1662
SL4	2-way Solder Link (Use Or 0603 Resistor)	Not applicable	Insert in Link Position "A"	FEC 933-1662
SL5	2-way Solder Link (Use Or 0603 Resistor)	Not applicable	Insert in Link Position "B"	FEC 933-1662
SL6	2-way Solder Link (Use Or 0603 Resistor)	Not applicable	Not applicable	Do not insert
SL7	2-way Solder Link (Use Or 0603 Resistor)	Not applicable	Insert in Link Position "A"	FEC 933-1662
SL8	2-way Solder Link (Use Or 0603 Resistor)	Not applicable	Insert in Link Position "A"	FEC 933-1662
SL9, SL10	2-way Solder Link (Use Or 0603 Resistor)	Not applicable	Insert in Link Position "A"	FEC 933-1662
SL11A	R0603, 0r	Vishay	CRCW06030000Z0EA	FEC 146-9739
SL11B, S11C	R0603, DNI	Vishay	CRCW06030000Z0EA	Do not insert
SL12 through SL15	Resistor, 1206, 0R	Multicomp	MC 0.125W 1206 0R	FEC 9336974
STAR3	Ground link (copper short)	Not applicable	Not applicable	Not applicable
U1	32 K I <sup>2</sup> C Serial EEPROM	Microchip Technology Inc.	24LC32A-I/MS	FEC1331330
U2	Linear Regulator 5 V, 20 V, 500 mA, Ultralow Noise, CMOS	Analog Devices, Inc.	<a href="#">ADP7104ARDZ-5.0</a>	<a href="#">ADP7104ARDZ-5.0</a>
U3	Quad Voltage Monitor and Sequencer	Analog Devices, Inc.	<a href="#">ADM1185ARMZ-1</a>	<a href="#">ADM1185ARMZ-1</a>
U4	5 V XFET Reference	Analog Devices, Inc.	<a href="#">ADR445BRZ</a>	<a href="#">ADR445BRZ</a>
U5	ADC	Analog Devices, Inc.	<a href="#">AD7175-8BCPZ</a>	<a href="#">AD7175-8BCPZ</a>
U6	Dual Op-Amp	Analog Devices, Inc.	<a href="#">AD8656ARZ</a>	<a href="#">AD8656ARZ</a>
U7	Ultra Low Power, Low Distortion ADC Driver, 4nV/rtHz	Analog Devices, Inc.	<a href="#">ADA4940-1ACPZ</a>	<a href="#">ADA4940-1ACPZ</a>
U8	50 mA, High Voltage, Micropower Linear Regulator –5V	Analog Devices, Inc.	<a href="#">ADP1720ARMZ-5-R7</a>	<a href="#">ADP1720ARMZ-5-R7</a>
U9	Fully Differential Funnel Amplifier	Analog Devices, Inc.	<a href="#">AD8475ARMZ</a>	<a href="#">AD8475ARMZ</a>
U10	Dual Op-Amp	Analog Devices, Inc.	<a href="#">AD8656ARZ</a>	<a href="#">AD8656ARZ</a>
U11	Linear Regulator, 50 mA, 3.3 V, MSOP-8	Analog Devices, Inc.	<a href="#">ADP1720ARMZ-3.3-R7</a>	<a href="#">ADP1720ARMZ-3.3-R7</a>

Name	Part Description	Manufacturer	Part Number	Stock Code
U12	50 mA, High Voltage, Micropower Adjustable Linear Regulator	Analog Devices, Inc.	<a href="#">ADP1720ARMZ-R7</a>	<a href="#">ADP1720ARMZ-R7</a>
V1 through V4, X1 through X2	Linear Regulator, 50 mA, 3.3 V, MSOP-8	Analog Devices, Inc.	Not applicable	Do not insert
Y1	Miniature Crystal SMD	Epson	FA-20H, 16 MHz, 10 PPM, 9 PF	FEC 171-2814
Y2	Ceralock Ceramic Resonator	Murata	CSTCE16M0V53-R0	490-1198-1-ND



## NOTES

I<sup>2</sup>C refers to a communications protocol originally developed by Philips Semiconductors (now NXP Semiconductors).



### ESD Caution

**ESD (electrostatic discharge) sensitive device.** Charged devices and circuit boards can discharge without detection. Although this product features patented or proprietary protection circuitry, damage may occur on devices subjected to high energy ESD. Therefore, proper ESD precautions should be taken to avoid performance degradation or loss of functionality.

### Legal Terms and Conditions

By using the evaluation board discussed herein (together with any tools, components documentation or support materials, the "Evaluation Board"), you are agreeing to be bound by the terms and conditions set forth below ("Agreement") unless you have purchased the Evaluation Board, in which case the Analog Devices Standard Terms and Conditions of Sale shall govern. Do not use the Evaluation Board until you have read and agreed to the Agreement. Your use of the Evaluation Board shall signify your acceptance of the Agreement. This Agreement is made by and between you ("Customer") and Analog Devices, Inc. ("ADI"), with its principal place of business at One Technology Way, Norwood, MA 02062, USA. Subject to the terms and conditions of the Agreement, ADI hereby grants to Customer a free, limited, personal, temporary, non-exclusive, non-sublicensable, non-transferable license to use the Evaluation Board FOR EVALUATION PURPOSES ONLY. Customer understands and agrees that the Evaluation Board is provided for the sole and exclusive purpose referenced above, and agrees not to use the Evaluation Board for any other purpose. Furthermore, the license granted is expressly made subject to the following additional limitations: Customer shall not (i) rent, lease, display, sell, transfer, assign, sublicense, or distribute the Evaluation Board; and (ii) permit any Third Party to access the Evaluation Board. As used herein, the term "Third Party" includes any entity other than ADI, Customer, their employees, affiliates and in-house consultants. The Evaluation Board is NOT sold to Customer; all rights not expressly granted herein, including ownership of the Evaluation Board, are reserved by ADI. CONFIDENTIALITY. This Agreement and the Evaluation Board shall all be considered the confidential and proprietary information of ADI. Customer may not disclose or transfer any portion of the Evaluation Board to any other party for any reason. Upon discontinuation of use of the Evaluation Board or termination of this Agreement, Customer agrees to promptly return the Evaluation Board to ADI. ADDITIONAL RESTRICTIONS. Customer may not disassemble, decompile or reverse engineer chips on the Evaluation Board. Customer shall inform ADI of any occurred damages or any modifications or alterations it makes to the Evaluation Board, including but not limited to soldering or any other activity that affects the material content of the Evaluation Board. Modifications to the Evaluation Board must comply with applicable law, including but not limited to the RoHS Directive. TERMINATION. ADI may terminate this Agreement at any time upon giving written notice to Customer. Customer agrees to return to ADI the Evaluation Board at that time. LIMITATION OF LIABILITY. THE EVALUATION BOARD PROVIDED HEREUNDER IS PROVIDED "AS IS" AND ADI MAKES NO WARRANTIES OR REPRESENTATIONS OF ANY KIND WITH RESPECT TO IT. ADI SPECIFICALLY DISCLAIMS ANY REPRESENTATIONS, ENDORSEMENTS, GUARANTEES, OR WARRANTIES, EXPRESS OR IMPLIED, RELATED TO THE EVALUATION BOARD INCLUDING, BUT NOT LIMITED TO, THE IMPLIED WARRANTY OF MERCHANTABILITY, TITLE, FITNESS FOR A PARTICULAR PURPOSE OR NONINFRINGEMENT OF INTELLECTUAL PROPERTY RIGHTS. IN NO EVENT WILL ADI AND ITS LICENSORS BE LIABLE FOR ANY INCIDENTAL, SPECIAL, INDIRECT, OR CONSEQUENTIAL DAMAGES RESULTING FROM CUSTOMER'S POSSESSION OR USE OF THE EVALUATION BOARD, INCLUDING BUT NOT LIMITED TO LOST PROFITS, DELAY COSTS, LABOR COSTS OR LOSS OF GOODWILL. ADI'S TOTAL LIABILITY FROM ANY AND ALL CAUSES SHALL BE LIMITED TO THE AMOUNT OF ONE HUNDRED US DOLLARS (\$100.00). EXPORT. Customer agrees that it will not directly or indirectly export the Evaluation Board to another country, and that it will comply with all applicable United States federal laws and regulations relating to exports. GOVERNING LAW. This Agreement shall be governed by and construed in accordance with the substantive laws of the Commonwealth of Massachusetts (excluding conflict of law rules). Any legal action regarding this Agreement will be heard in the state or federal courts having jurisdiction in Suffolk County, Massachusetts, and Customer hereby submits to the personal jurisdiction and venue of such courts. The United Nations Convention on Contracts for the International Sale of Goods shall not apply to this Agreement and is expressly disclaimed.

©2015–2018 Analog Devices, Inc. All rights reserved. Trademarks and registered trademarks are the property of their respective owners.  
UG13767-0-1/18(A)



www.analog.com