



Is Now Part of



ON Semiconductor®

To learn more about ON Semiconductor, please visit our website at
www.onsemi.com

Please note: As part of the Fairchild Semiconductor integration, some of the Fairchild orderable part numbers will need to change in order to meet ON Semiconductor's system requirements. Since the ON Semiconductor product management systems do not have the ability to manage part nomenclature that utilizes an underscore (_), the underscore (_) in the Fairchild part numbers will be changed to a dash (-). This document may contain device numbers with an underscore (_). Please check the ON Semiconductor website to verify the updated device numbers. The most current and up-to-date ordering information can be found at www.onsemi.com. Please email any questions regarding the system integration to Fairchild_questions@onsemi.com.

ON Semiconductor and the ON Semiconductor logo are trademarks of Semiconductor Components Industries, LLC dba ON Semiconductor or its subsidiaries in the United States and/or other countries. ON Semiconductor owns the rights to a number of patents, trademarks, copyrights, trade secrets, and other intellectual property. A listing of ON Semiconductor's product/patent coverage may be accessed at www.onsemi.com/site/pdf/Patent-Marking.pdf. ON Semiconductor reserves the right to make changes without further notice to any products herein. ON Semiconductor makes no warranty, representation or guarantee regarding the suitability of its products for any particular purpose, nor does ON Semiconductor assume any liability arising out of the application or use of any product or circuit, and specifically disclaims any and all liability, including without limitation special, consequential or incidental damages. Buyer is responsible for its products and applications using ON Semiconductor products, including compliance with all laws, regulations and safety requirements or standards, regardless of any support or applications information provided by ON Semiconductor. "Typical" parameters which may be provided in ON Semiconductor data sheets and/or specifications can and do vary in different applications and actual performance may vary over time. All operating parameters, including "Typicals" must be validated for each customer application by customer's technical experts. ON Semiconductor does not convey any license under its patent rights nor the rights of others. ON Semiconductor products are not designed, intended, or authorized for use as a critical component in life support systems or any FDA Class 3 medical devices or medical devices with a same or similar classification in a foreign jurisdiction or any devices intended for implantation in the human body. Should Buyer purchase or use ON Semiconductor products for any such unintended or unauthorized application, Buyer shall indemnify and hold ON Semiconductor and its officers, employees, subsidiaries, affiliates, and distributors harmless against all claims, costs, damages, and expenses, and reasonable attorney fees arising out of, directly or indirectly, any claim of personal injury or death associated with such unintended or unauthorized use, even if such claim alleges that ON Semiconductor was negligent regarding the design or manufacture of the part. ON Semiconductor is an Equal Opportunity/Affirmative Action Employer. This literature is subject to all applicable copyright laws and is not for resale in any manner.

FSTD16211 24-Bit Bus Switch with Level Shifting

General Description

The Fairchild Switch FSTD16211 provides 24-bits of high-speed CMOS TTL-compatible bus switching. The low On Resistance of the switch allows inputs to be connected to outputs without adding propagation delay or generating additional ground bounce noise. A diode to V_{CC} has been integrated into the circuit to allow for level shifting between 5V inputs and 3.3V outputs.

The device is organized as a 12-bit or 24-bit bus switch. When \overline{OE}_1 is LOW, the switch is ON and Port 1A is connected to Port 1B. When \overline{OE}_2 is LOW, Port 2A is connected to Port 2B. When $\overline{OE}_{1/2}$ is HIGH, a high impedance state exists between the A and B Ports.

Features

- 4Ω switch connection between two ports
- Voltage level shifting
- Minimal propagation delay through the switch
- Low I_{CC}
- Zero bounce in flow-through mode
- Control inputs compatible with TTL level
- Also packaged in plastic Fine-Pitch Ball Grid Array (FBGA)

Ordering Code:

Order Number	Package Number	Package Description
FSTD16211G (Note 1)(Note 2)	BGA54A	54-Ball Fine-Pitch Ball Grid Array (FBGA), JEDEC MO-205, 5.5mm Wide [TAPE and REEL]
FSTD16211MTD (Note 2)	MTD56	56-Lead Thin Shrink Small Outline Package (TSSOP), JEDEC MO-153, 6.1mm Wide

Note 1: Ordering code "G" indicates Trays.

Note 2: Devices also available in Tape and Reel. Specify by appending the suffix letter "X" to the ordering code.

Logic Diagram

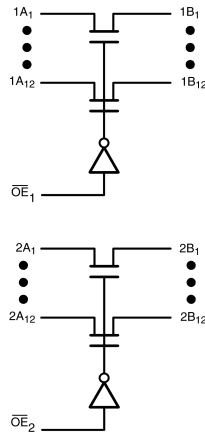

Connection Diagrams

Pin Assignment for TSSOP

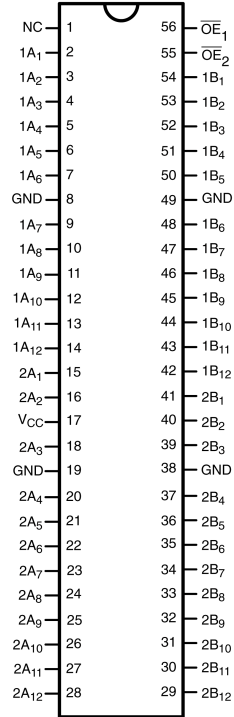

Pin Assignment for FBGA

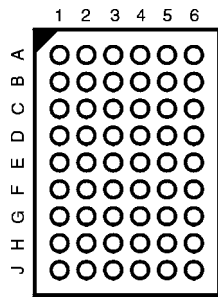

(Top Thru View)

Pin Descriptions

Pin Name	Description
$\overline{OE}_1, \overline{OE}_2$	Bus Switch Enables
1A, 2A	Bus A
1B, 2B	Bus B
NC	No Connect

Pin Assignment for FBGA

	1	2	3	4	5	6
A	1A ₂	1A ₁	NC	OE ₂	1B ₁	1B ₂
B	1A ₄	1A ₃	1A ₇	OE ₁	1B ₃	1B ₄
C	1A ₆	1A ₅	GND	1B ₇	1B ₅	1B ₆
D	1A ₁₀	1A ₉	1A ₈	1B ₈	1B ₉	1B ₁₀
E	1A ₁₂	1A ₁₁	2A ₁	2B ₁	1B ₁₁	1B ₁₂
F	2A ₄	2A ₃	2A ₂	2B ₂	2B ₃	2B ₄
G	2A ₆	2A ₅	V _{CC}	GND	2B ₅	2B ₆
H	2A ₈	2A ₇	2A ₉	2B ₉	2B ₇	2B ₈
J	2A ₁₂	2A ₁₁	2A ₁₀	2B ₁₀	2B ₁₁	2B ₁₂

Truth Table

Inputs		Inputs/Outputs	
\overline{OE}_1	\overline{OE}_2	1A, 1B	2A, 2B
L	L	1A = 1B	2A = 2B
L	H	1A = 1B	Z
H	L	Z	2A = 2B
H	H	Z	Z

Absolute Maximum Ratings (Note 3)

Supply Voltage (V_{CC})	-0.5V to +7.0V
DC Switch Voltage (V_S) (Note 4)	-0.5V to +7.0V
DC Input Control Pin Voltage (V_{IN}) (Note 5)	-0.5V to +7.0V
DC Input Diode Current (I_{IK}) $V_{IN} < 0V$	-50 mA
DC Output (I_{OUT})	128 mA
DC V_{CC}/GND Current (I_{CC}/I_{GND})	+/- 100 mA
Storage Temperature Range (T_{STG})	-65°C to +150 °C

Recommended Operating Conditions (Note 6)

Power Supply Operating (V_{CC})	4.5V to 5.5V
Input Voltage (V_{IN})	0V to 5.5V
Output Voltage (V_{OUT})	0V to 5.5V
Input Rise and Fall Time (t_r, t_f)	
Switch Control Input	0 ns/V to 5 ns/V
Switch I/O	0 ns/V to DC
Free Air Operating Temperature (T_A)	-40 °C to +85 °C

Note 3: The "Absolute Maximum Ratings" are those values beyond which the safety of the device cannot be guaranteed. The device should not be operated at these limits. The parametric values defined in the Electrical Characteristics tables are not guaranteed at the absolute maximum rating. The "Recommended Operating Conditions" table will define the conditions for actual device operation.

Note 4: V_S is the voltage observed/applied at either A or B Ports across the switch.

Note 5: The input and output negative voltage ratings may be exceeded if the input and output diode current ratings are observed.

Note 6: Unused control inputs must be held HIGH or LOW. They may not float.

DC Electrical Characteristics

Symbol	Parameter	V_{CC} (V)	$T_A = -40\text{ °C to }+85\text{ °C}$			Units	Conditions
			Min	Typ (Note 7)	Max		
V_{IK}	Clamp Diode Voltage	4.5			-1.2	V	$I_{IN} = -18\text{ mA}$
V_{IH}	HIGH Level Input Voltage	4.5-5.5	2.0			V	
V_{IL}	LOW Level Input Voltage	4.5-5.5			0.8	V	
V_{OH}	HIGH Level	4.5-5.5	See Figure 3			V	
I_I	Input Leakage Current	5.5			±1.0	µA	$0 \leq V_{IN} \leq 5.5V$
		0			10	µA	$V_{IN} = 5.5V$
I_{OZ}	OFF-STATE Leakage Current	5.5			±1.0	µA	$0 \leq A, B \leq V_{CC}$
R_{ON}	Switch On Resistance (Note 8)	4.5		4	7	Ω	$V_{IN} = 0V, I_{IN} = 64\text{ mA}$
		4.5		4	7	Ω	$V_{IN} = 0V, I_{IN} = 30\text{ mA}$
		4.5		35	50	Ω	$V_{IN} = 2.4V, I_{IN} = 15\text{ mA}$
I_{CC}	Quiescent Supply Current	5.5			1.5	mA	$OE_1 = OE_2 = GND$ $V_{IN} = V_{CC}$ or $GND, I_{OUT} = 0$
					10	µA	$OE_1 = OE_2 = V_{CC}$ $V_{IN} = V_{CC}$ or $GND, I_{OUT} = 0$
I_{CCT}	Increase in I_{CC} per Control Input	5.5			2.5	mA	One Control Input at 3.4V Other Control Inputs at V_{CC} or GND

Note 7: Typical values are at $V_{CC} = 5.0V$ and $T_A = +25\text{ °C}$

Note 8: Measured by the voltage drop between A and B pins at the indicated current through the switch. On Resistance is determined by the lower of the voltages on the two (A or B) pins.

AC Electrical Characteristics

Symbol	Parameter	$T_A = -40\text{ }^\circ\text{C to } +85\text{ }^\circ\text{C}$,		Units	Conditions	Figure Number
		$C_L = 50\text{pF, } R_U = R_D = 500\Omega$				
		$V_{CC} = 4.5 - 5.5\text{V}$				
	Min	Max				
t_{PHL}, t_{PLH}	Propagation Delay Bus to Bus (Note 9)		0.25	ns	$V_I = \text{OPEN}$	Figures 1, 2
t_{PZH}, t_{PZL}	Output Enable Time	1.5	5.5	ns	$V_I = 7\text{V}$ for t_{PZL} $V_I = \text{OPEN}$ for t_{PZH}	Figures 1, 2
t_{PHZ}, t_{PLZ}	Output Disable Time	1.5	6.5	ns	$V_I = 7\text{V}$ for t_{PLZ} $V_I = \text{OPEN}$ for t_{PHZ}	Figures 1, 2

Note 9: This parameter is guaranteed by design but is not tested. The bus switch contributes no propagation delay other than the RC delay of the typical On Resistance of the switch and the 50pF load capacitance, when driven by an ideal voltage source (zero output impedance).

Capacitance (Note 10)

Symbol	Parameter	Typ	Max	Units	Conditions
C_{IN}	Control Pin Input Capacitance	3.5		pF	$V_{CC} = 5.0\text{V}$
$C_{I/O}$	Input/Output Capacitance	5.5		pF	$V_{CC}, \overline{OE} = 5.0\text{V}$

Note 10: $T_A = +25\text{ }^\circ\text{C}$, $f = 1\text{ MHz}$, Capacitance is characterized but not tested.

AC Loading and Waveforms

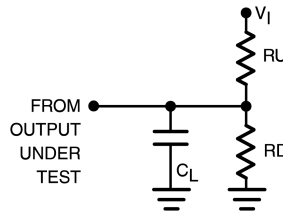

Note: Input driven by 50Ω source terminated in 50Ω

Note: C_L includes load and stray capacitance

Note: Input PRR = 1.0 MHz, $t_W = 500\text{ ns}$

FIGURE 1. AC Test Circuit

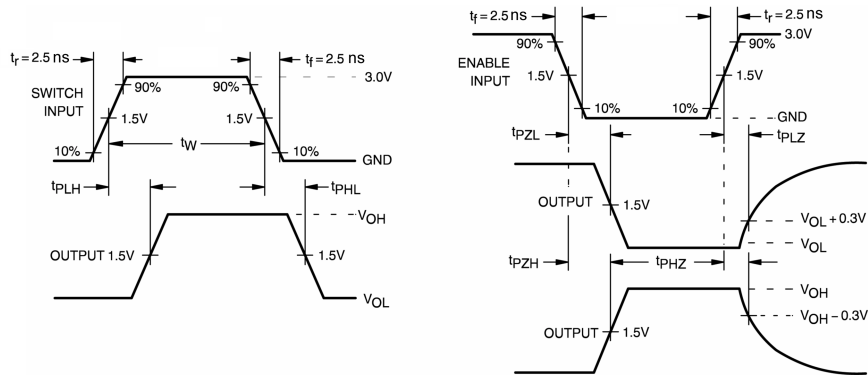

FIGURE 2. AC Waveforms

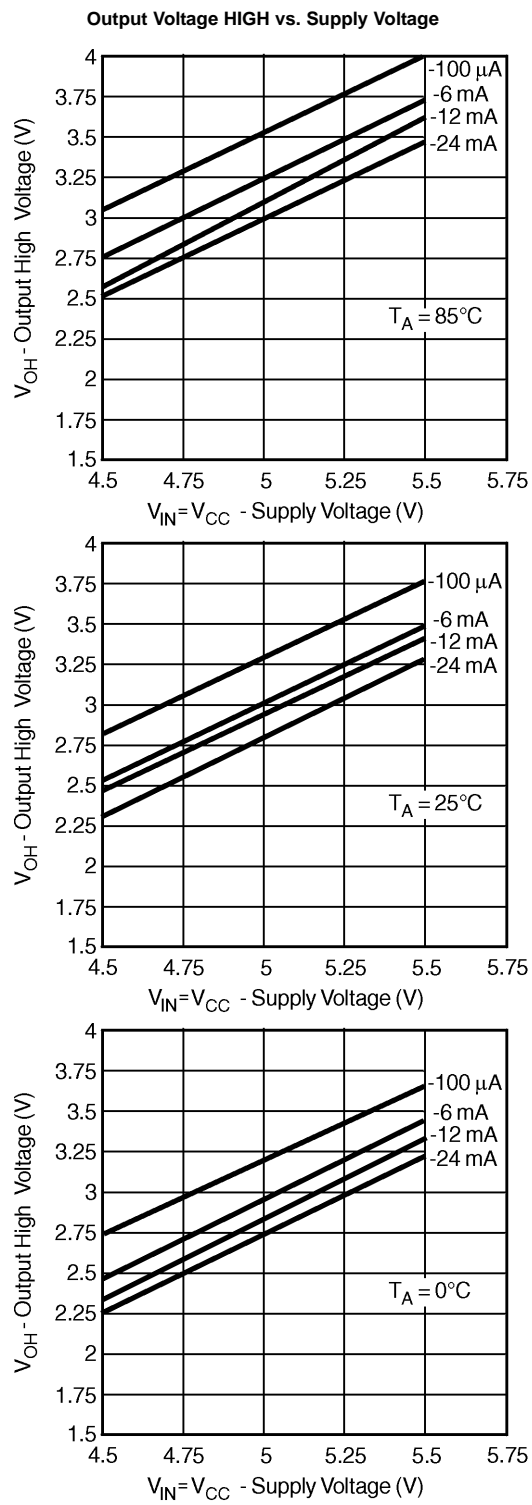
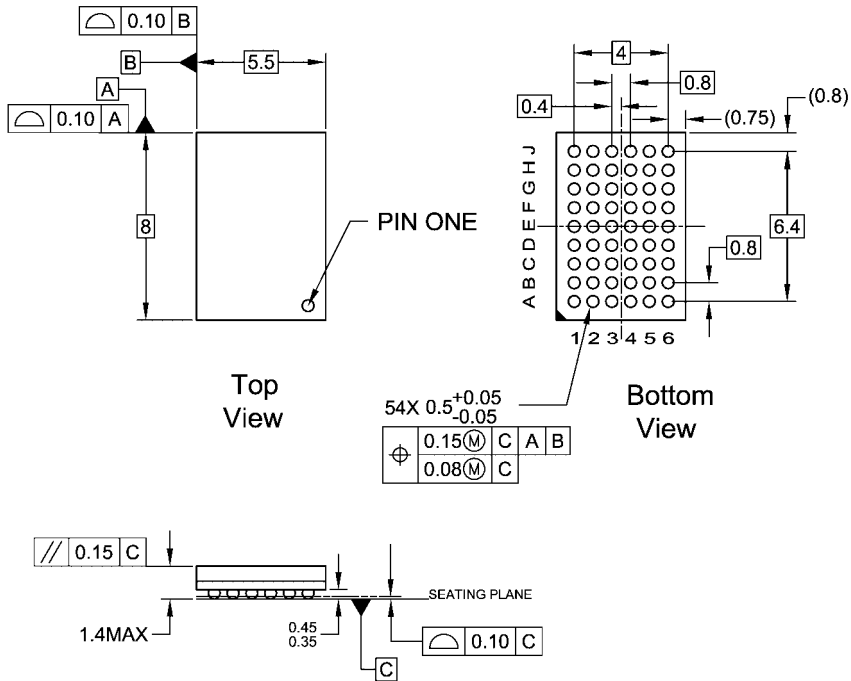

FIGURE 3.

Physical Dimensions inches (millimeters) unless otherwise noted



NOTES:

- A. THIS PACKAGE CONFORMS TO JEDEC M0-205
- B. ALL DIMENSIONS IN MILLIMETERS
- C. LAND PATTERN RECOMMENDATION: NSMD (Non Solder Mask Defined)
.35MM DIA PADS WITH A SOLDERMASK OPENING OF .45MM CONCENTRIC TO PADS
- D. DRAWING CONFORMS TO ASME Y14.5M-1994

BGA54ArevD

**54-Ball Fine-Pitch Ball Grid Array (FBGA), JEDEC MO-205, 5.5mm Wide
Package Number BGA54A**

Physical Dimensions inches (millimeters) unless otherwise noted (Continued)

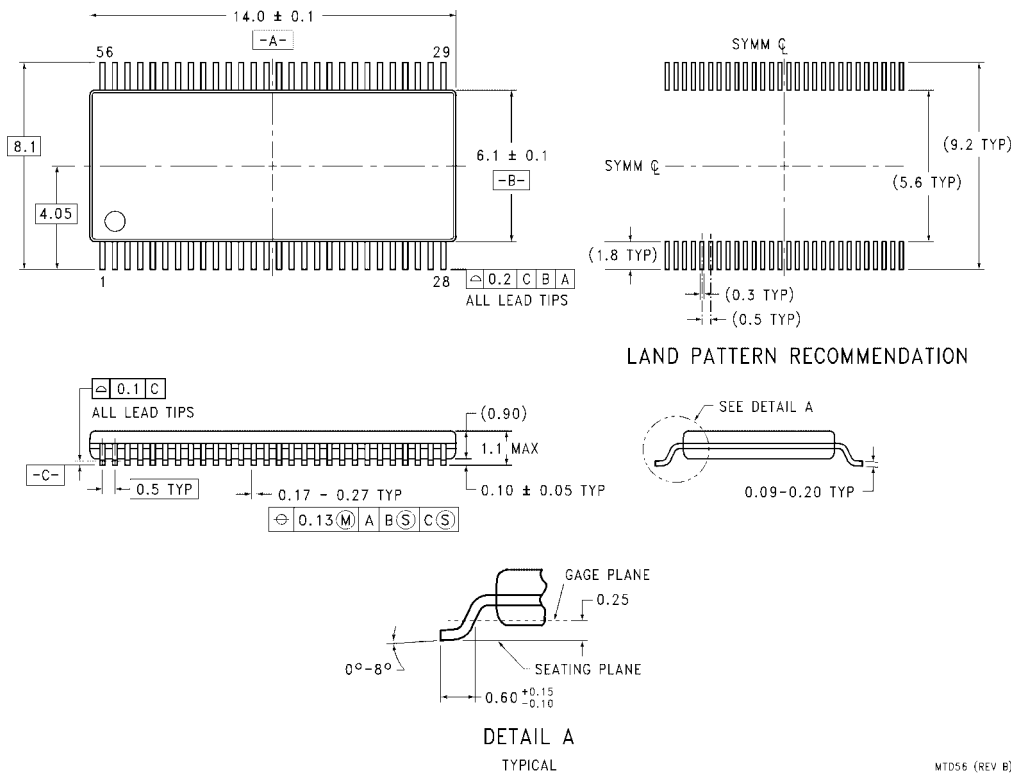

**56-Lead Thin Shrink Small Outline Package (TSSOP), JEDEC MO-153, 6.1mm Wide
Package Number MTD56**

Technology Description

The Fairchild Switch family derives from and embodies Fairchild's proven switch technology used for several years in its 74LVX3L384 (FST3384) bus switch product.

Fairchild does not assume any responsibility for use of any circuitry described, no circuit patent licenses are implied and Fairchild reserves the right at any time without notice to change said circuitry and specifications.

LIFE SUPPORT POLICY

FAIRCHILD'S PRODUCTS ARE NOT AUTHORIZED FOR USE AS CRITICAL COMPONENTS IN LIFE SUPPORT DEVICES OR SYSTEMS WITHOUT THE EXPRESS WRITTEN APPROVAL OF THE PRESIDENT OF FAIRCHILD SEMICONDUCTOR CORPORATION. As used herein:

1. Life support devices or systems are devices or systems which, (a) are intended for surgical implant into the body, or (b) support or sustain life, and (c) whose failure to perform when properly used in accordance with instructions for use provided in the labeling, can be reasonably expected to result in a significant injury to the user.
2. A critical component in any component of a life support device or system whose failure to perform can be reasonably expected to cause the failure of the life support device or system, or to affect its safety or effectiveness.

www.fairchildsemi.com

ON Semiconductor and  are trademarks of Semiconductor Components Industries, LLC dba ON Semiconductor or its subsidiaries in the United States and/or other countries. ON Semiconductor owns the rights to a number of patents, trademarks, copyrights, trade secrets, and other intellectual property. A listing of ON Semiconductor's product/patent coverage may be accessed at www.onsemi.com/site/pdf/Patent-Marking.pdf. ON Semiconductor reserves the right to make changes without further notice to any products herein. ON Semiconductor makes no warranty, representation or guarantee regarding the suitability of its products for any particular purpose, nor does ON Semiconductor assume any liability arising out of the application or use of any product or circuit, and specifically disclaims any and all liability, including without limitation special, consequential or incidental damages. Buyer is responsible for its products and applications using ON Semiconductor products, including compliance with all laws, regulations and safety requirements or standards, regardless of any support or applications information provided by ON Semiconductor. "Typical" parameters which may be provided in ON Semiconductor data sheets and/or specifications can and do vary in different applications and actual performance may vary over time. All operating parameters, including "Typicals" must be validated for each customer application by customer's technical experts. ON Semiconductor does not convey any license under its patent rights nor the rights of others. ON Semiconductor products are not designed, intended, or authorized for use as a critical component in life support systems or any FDA Class 3 medical devices or medical devices with a same or similar classification in a foreign jurisdiction or any devices intended for implantation in the human body. Should Buyer purchase or use ON Semiconductor products for any such unintended or unauthorized application, Buyer shall indemnify and hold ON Semiconductor and its officers, employees, subsidiaries, affiliates, and distributors harmless against all claims, costs, damages, and expenses, and reasonable attorney fees arising out of, directly or indirectly, any claim of personal injury or death associated with such unintended or unauthorized use, even if such claim alleges that ON Semiconductor was negligent regarding the design or manufacture of the part. ON Semiconductor is an Equal Opportunity/Affirmative Action Employer. This literature is subject to all applicable copyright laws and is not for resale in any manner.

PUBLICATION ORDERING INFORMATION

LITERATURE FULFILLMENT:

Literature Distribution Center for ON Semiconductor
19521 E. 32nd Pkwy, Aurora, Colorado 80011 USA
Phone: 303-675-2175 or 800-344-3860 Toll Free USA/Canada
Fax: 303-675-2176 or 800-344-3867 Toll Free USA/Canada
Email: orderlit@onsemi.com

N. American Technical Support: 800-282-9855 Toll Free
USA/Canada
Europe, Middle East and Africa Technical Support:
Phone: 421 33 790 2910
Japan Customer Focus Center
Phone: 81-3-5817-1050

ON Semiconductor Website: www.onsemi.com
Order Literature: <http://www.onsemi.com/orderlit>
For additional information, please contact your local
Sales Representative