



RN-ISP-UM

In-System Programmer

© 2012 Roving Networks. All rights reserved.
RN-ISP-UM-1.1 Version 1.1 1/19/2012

USER MANUAL

OVERVIEW

You use Roving Networks In-System-Programmer (ISP), RN-ISP, to download code to WiFly modules and debug it. The ISP can download code to the WiFly evaluation boards if they have a 16 or 10-pin debug header. The ISP measures current consumption and plots the power profiles of the WiFly modules in different power states. It also exposes the hardware signals and certain GPIO pins for debugging. The ISP has reset and wake buttons that help with debugging applications.

The RN-ISP is part of the RN-SDK, which consists of:

- *RN-IDK*—This board contains the WiFly module, dual power supplies, multiple hardware interfaces (e.g., UART, SDIO/SPI slave, and SPI master), and current measurement capability that allows power profiling of the WiFly module.
- *RN-ISP*—The ISP provides a means to download and debug application code to the WiFly module.
- *USB cable*—This cable connects the RN-ISP to a Linux-based development computer's USB port.
- *16-way ribbon cable*—This cable provides data and power connections between the RN-ISP and the RN-IDK.

PREREQUISITES

Before using the RN-ISP, you must have the following hardware and software:

- Development PC with Linux and a USB port.
- Configuration permissions for the development PC. Developers should have an account on the development PC with either sudo (if using Ubuntu) or root access.
- RN-SDK hardware.
- Jira access to software tools and libraries for developing applications on the WiFly module.

NOTE: The development environment is Linux. You cannot development firmware in the Windows or Mac environments.

CONNECTING THE RN-ISP TO THE DEVELOPMENT PC & RN-IDK

Connect the components of the RN-IDK using the following steps:

1. Connect the USB cable from the RN-ISP to the development PC.
2. Connect the ISP 16-way ribbon cable from the RN-ISP to the RN-IDK's H1 connector.

To install the RN-ISP, follow the instructions in EPSILON-6, EPSILON-1. Also refer to Known Issues (KNOWN-24) for additional information.

Figure 1 shows the connection setup. The RN-ISP provides power to the RN-IDK.

Figure 1. RN-ISP Connected to the Development PC

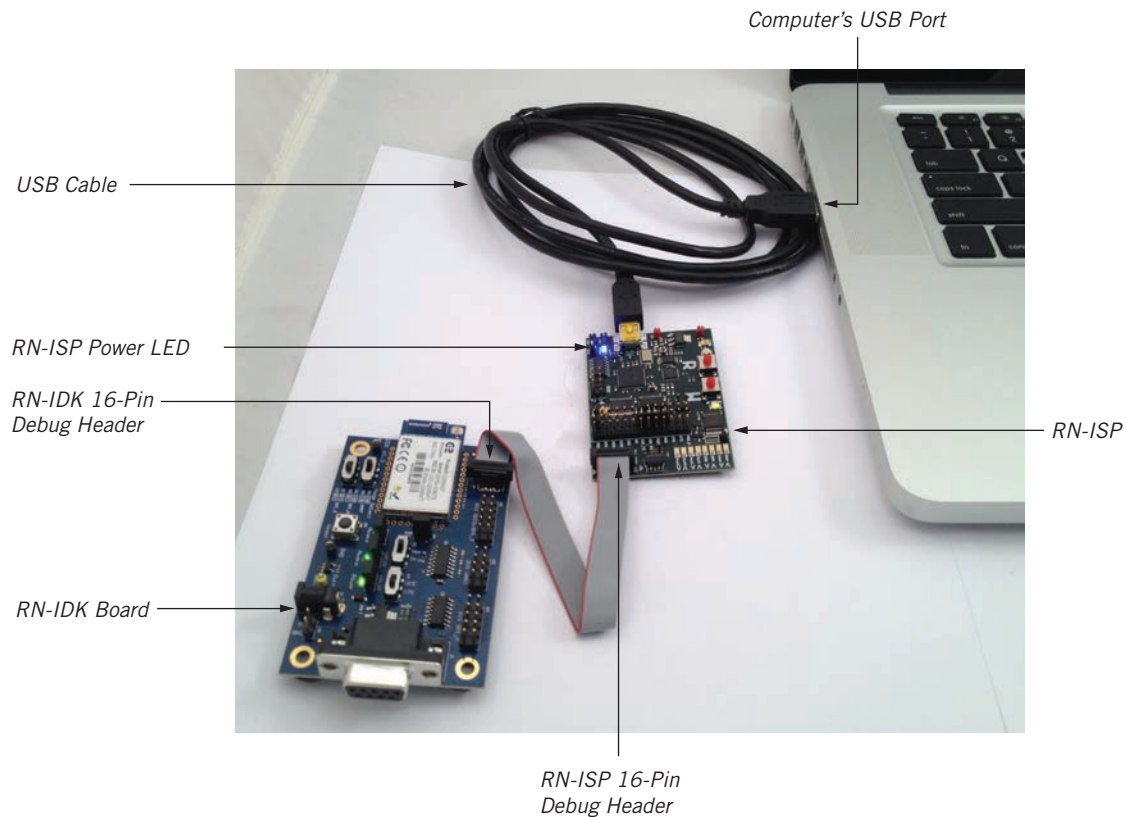

BOARD DESCRIPTION

Figure 2 describes the components on the RN-ISP development board and Figure 3 describes the pins and jumpers. Table 1 provides more detail on the probe hooks.

Figure 2. RN-ISP Board Description

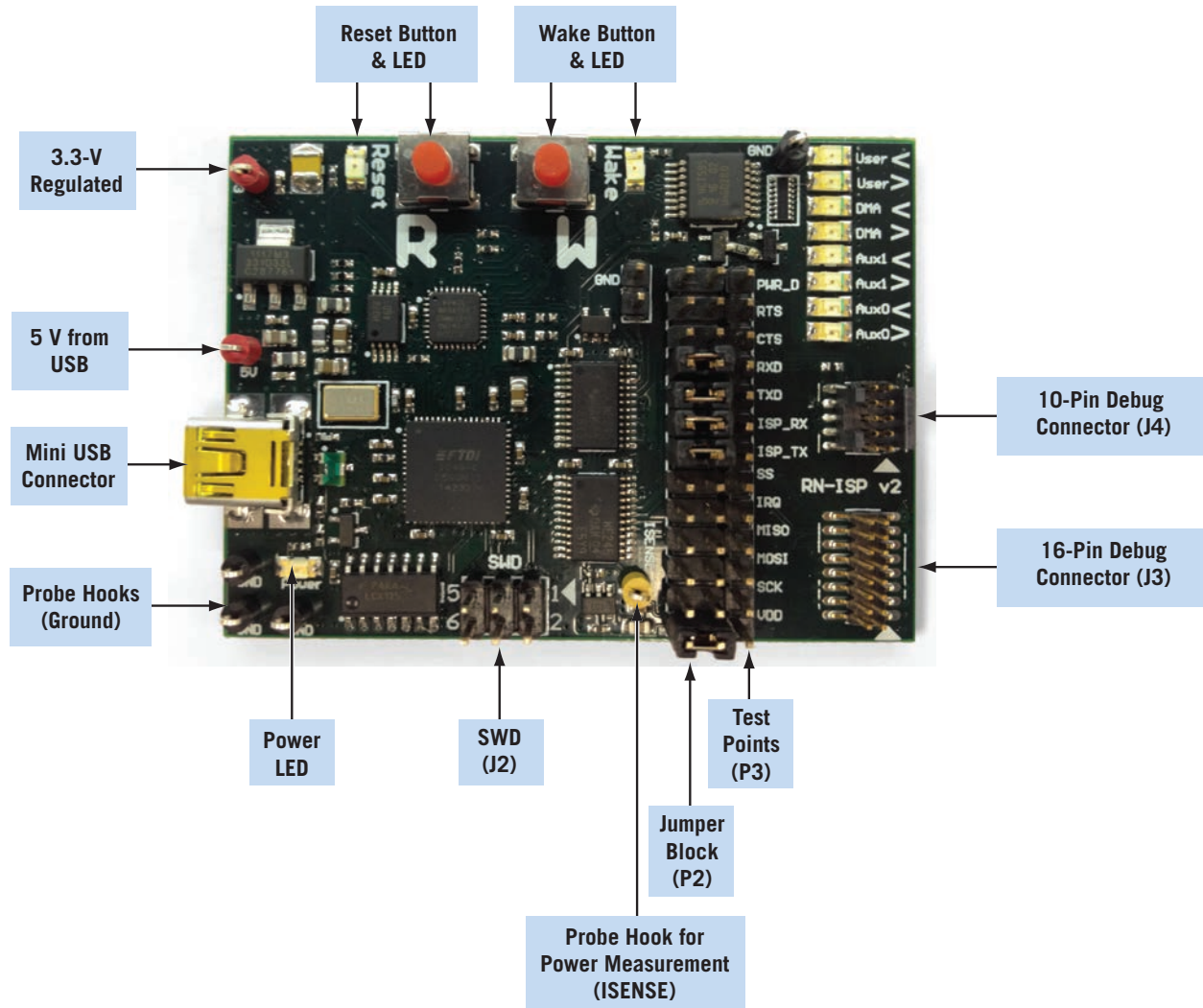
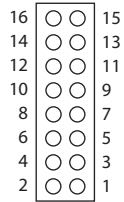

Table 1. Probe Hook Detail

Probe Hook Color	Description
Black	Ground
Red	Power (3.3 or 5 V)
Yellow	ISENSE

Figure 3. RN-ISP Pin Description

16-Pin Debug Connector (J3)



Pin	Description
1	GND
2	VDD_TARGET
3	ISP_DMA_RX
4	ISP_USER_TX
5	ISP_WAKE
6	ISP_RESET
7	ISP_DMA_TX
8	ISP_USER_RX
9	VDD_TARGET
10	GND
11	ISP_SCK
12	ISP_MOSI
13	ISP_MISO
14	ISP_IRQ
15	ISP_SS
16	ISP_PWR_DOWN

Jumper Block (P2)

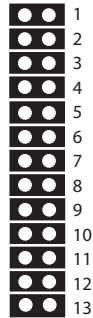

Row	Description
1	PWR_DOWN
2	USER_RTS
3	USER_CTS
4	USER_RX
5	USER_TX
6	DMA_RX
7	DMA_TX
8	SS
9	IRQ
10	MISO
11	MOSI
12	SCK
13	VDD_3V3_SW

10-Pin Debug Connector (J4)

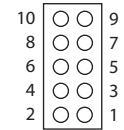

Pin	Description
1	GND
2	VDD_TARGET
3	ISP_DMA_RX
4	ISP_USER_TX
5	ISP_WAKE
6	ISP_RESET
7	ISP_DMA_TX
8	ISP_USER_RX
9	ISP_USER_CTS
10	ISP_USER_RTS

SWD (J2)

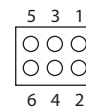

Pins	Description
1	3.3-V VDD
2	SWD_DATA
3	GND
4	GND
5	SWD_CLK
6	No connect

USING CUSTOM FIRMWARE

You can develop custom firmware and load it into the WiFly module's flash memory. The following sections describe how to load and run custom applications.

Load an Application into Flash Memory

Applications are stored in the WiFly module's flash memory. To load applications onto the flash memory, you use the module's **DMA_UART** port. To load the Hello World example application, perform the following steps:

1. Connect the hardware as described previously.
2. Open a terminal window on the development computer.
3. Change directory to the **examples** directory, which contains the Hello World application.
4. Build and load the application image into flash memory using the **make load** <cr> command.

Roving Networks provides a variety of example applications, all of which include a makefile with a make target named **load**.

Run the Application

Once the application has been loaded successfully, open a console window and launch a terminal program such as minicom to monitor the output on the UART port. To start the application, assert the reset momentarily by pressing and releasing the RN-ISP's reset button. Your application begins running. See Figure 4.

Figure 4. Hello World Example Application

```
<SDK Version C-0.3.1>
Hello World.
```

Reset & Wake Buttons

The RN-ISP board has reset and wake buttons to reset and wake the application. To assert the **RESET** signal, press and hold the reset button until the LED turns on, which causes your application to restart. To de-assert the **RESET** signal, press the reset button again and the LED turns off.

To wake the module from sleep, press and hold the wake button. The wake LED turns on indicating that the **WAKE** signal is asserted, causing your application to wake from sleep. To de-assert the **WAKE** signal, press the wake button again. The LED turns off.

CONNECT THE RN-ISP TO EVALUATION BOARDS

Application developers can use the WiFly evaluation boards as a prototyping platform for their applications. You can download application code to the board using a 16 or 10-pin header attached to the 16-way ribbon cable of the RN-ISP.

Connect to the RN-134 Evaluation Board

Pin1 (indicate with a square pad) on the 10-pin debug header on the RN-134 board must align with the 16-way ribbon cable's red wire as shown in Figure 5. You must use a 10-pin header to connect the 16-way ribbon cable and the 10-pin debug port.

Figure 5. Connect the RN-ISP to the RN-134 Board

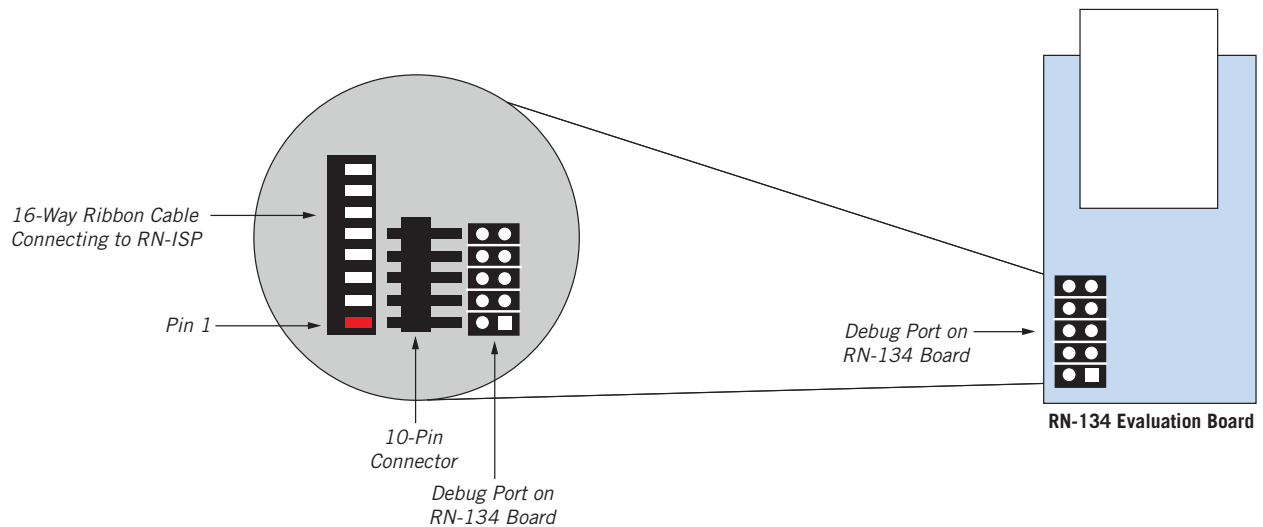

Connect to the RN-174 Evaluation Board

Pin1 (indicate with a square pad) on the 16-pin debug header on the RN-174 board must align with the 16-way ribbon cable's red wire as shown in Figure 6. You must use a 16-pin header to connect the 16-way ribbon cable and the 16-pin debug port.

Figure 6. Connect the RN-ISP to the RN-174 Board

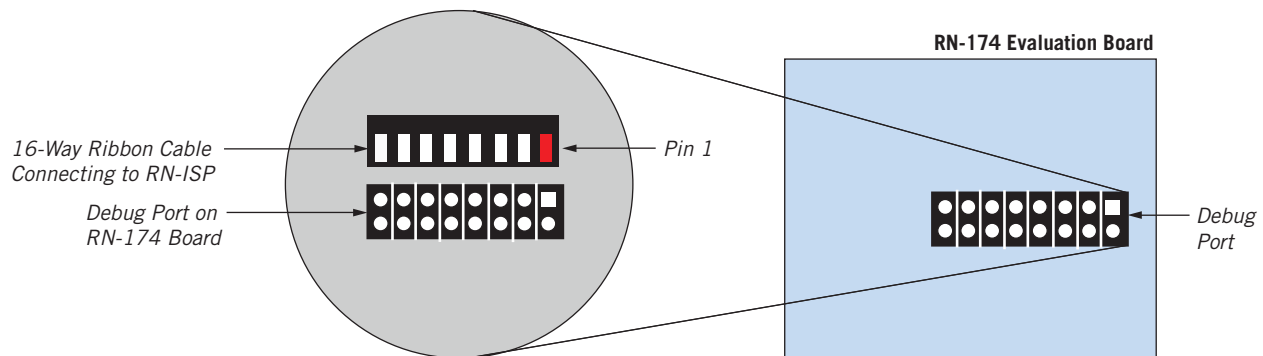

USING ROVING NETWORKS FIRMWARE ON THE WIFLY MODULE

You can use the ISP to monitor and configure the WiFly module while it is running a Roving Networks application. Additionally, you can go into command mode and configure the various parameters using the ASCII command interface. The RN-ISP can be used to configure Roving Networks firmware from a Linux, Windows, or Mac computer. However, before you can use the RN-ISP with a Windows or a Mac computer, you must install FTDI chip drivers from the FTDI website at <http://www.ftdichip.com/Drivers/VCP.htm>. Refer to “Appendix A: Installing FTDI drivers for Windows” on page 9 for installation instructions.

NOTE: You cannot develop firmware on a Windows or Mac computer. However, you can use Windows, Mac, or Linux computers to monitor and configure the firmware.

Launch a terminal emulator program and select the user UART COM port. The default COM port settings are 9,600 baud, 8 bits, no parity, and 1 stop bit. Enter the escape sequence `$$$` to go into command mode. The module returns **CMD** indicating that it is in command mode.

For a complete list of commands, refer to the command reference section in the *WiFly Advanced User Manual*, which is available on the Support page of the Roving Networks web site at http://www.rovingnetworks.com/Support_Overview.

Figure 7 shows how to connect the RN-134 board to a PC.

Figure 7. Connecting the RN-134 to your PC

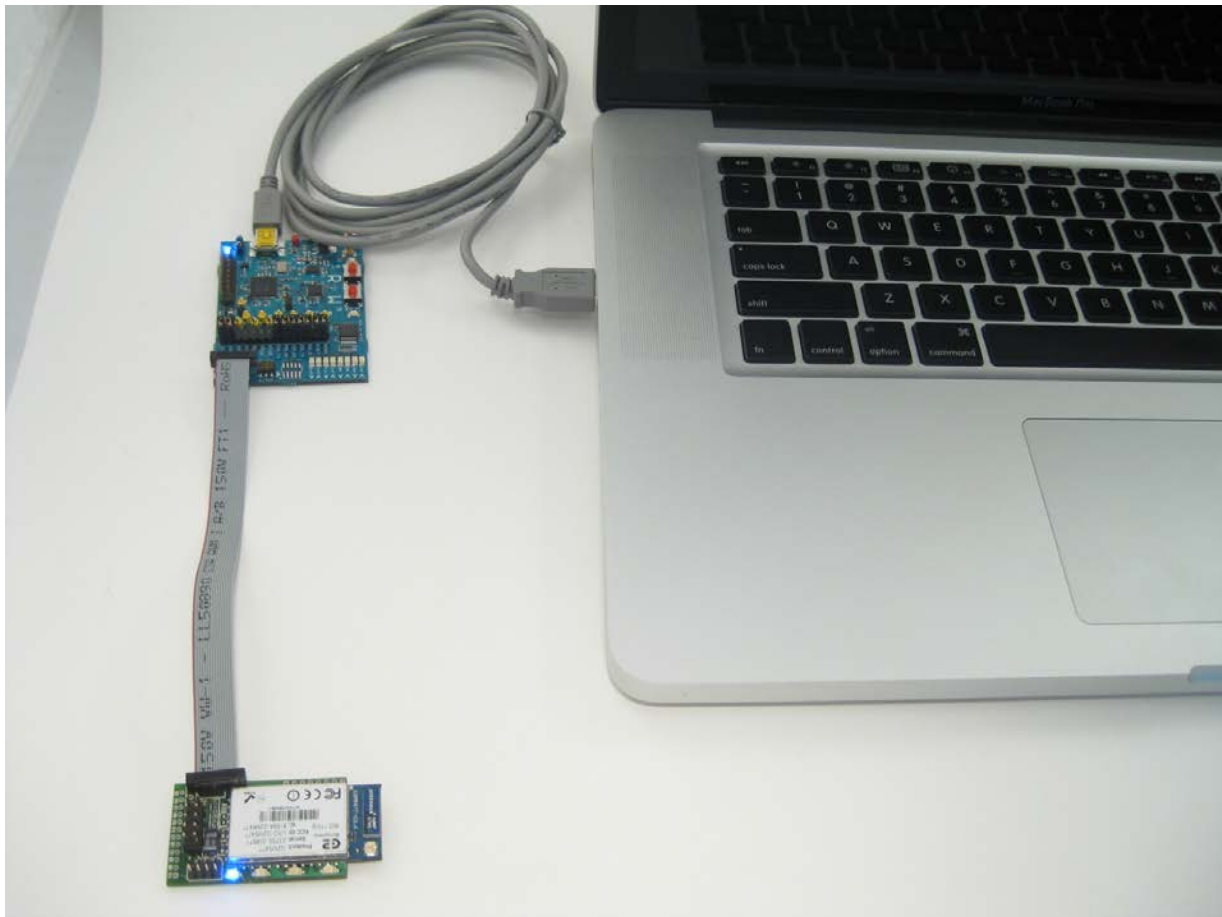

APPENDIX A: INSTALLING FTDI DRIVERS FOR WINDOWS

Before using the RN-ISP to download firmware or configure the RN-131 or RN-171 module using their respective development boards (RN-134 or RN-174), you must first install FTDI drivers. You can download the drivers from the FTDI website at <http://www.ftdichip.com/Drivers/VCP.htm>. After you download the drivers perform these steps to configure the COM ports:

1. Run the FTDI driver executable to install it.
2. When the driver finishes installing, connect the RN-ISP to the USB port of your computer.
3. Open your PC's device manager. You will see four USB serial converter devices: A, B, C, and D as shown in Figure 8.

Figure 8. FTDI Drivers in the Device Manager

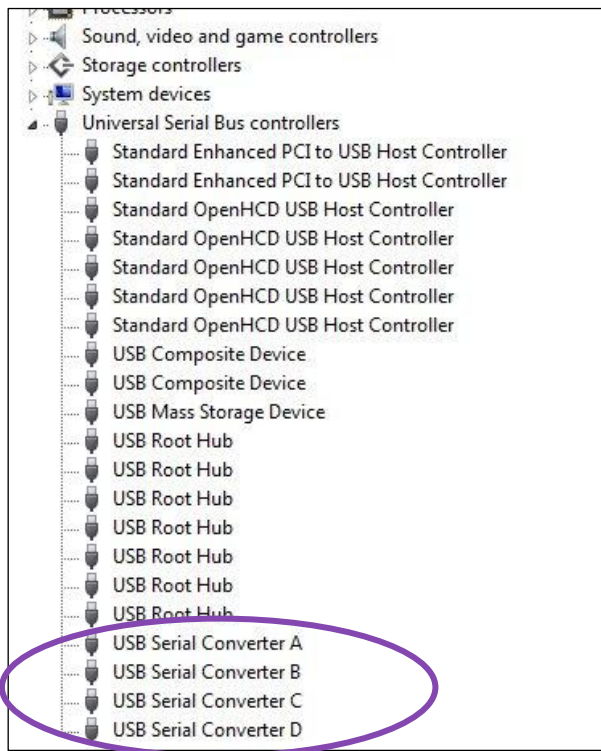

4. Go to the properties menu of each USB serial converter and turn on the **Load VCP** option as shown in Figure 9

Figure 9. Turn On Load VCP Option

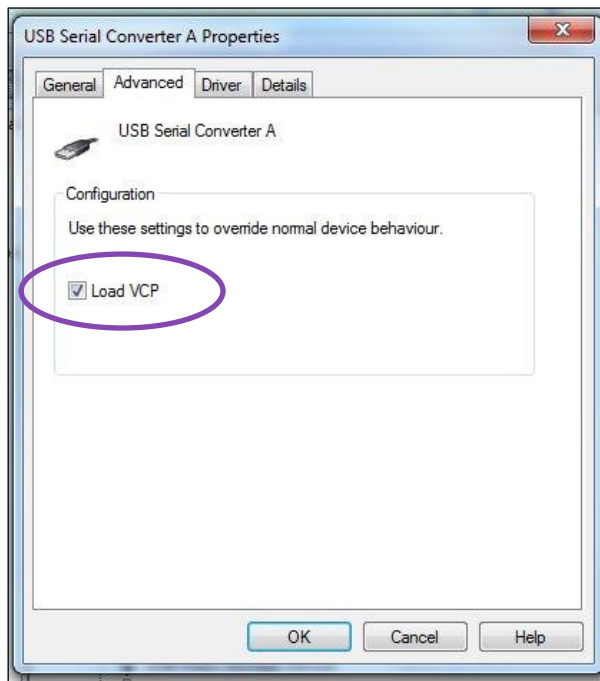

5. Disconnect the RN-ISP from your computer's USB port.
6. Re-connect the RN-ISP to your computer's USB port. The appropriate COM ports are created in the Ports section of the device manager (COM and LPT) as shown in **Error! Reference source not found.**Figure 10. You may need to reboot your Windows machine for the COM ports to be created. Windows typically creates four sequential COM ports (COM 3, 4, 5, and 6 in this example).

The highest COM port is the user UART, which you use to configure the module. In **Error! Reference source not found.**Figure 10, COM 6 is the user UART. The second highest COM port is used to flash firmware to the module using the **flash loader** utility. In this example, COM 5 is used to flash firmware.

Figure 10. RN-ISP COM Ports

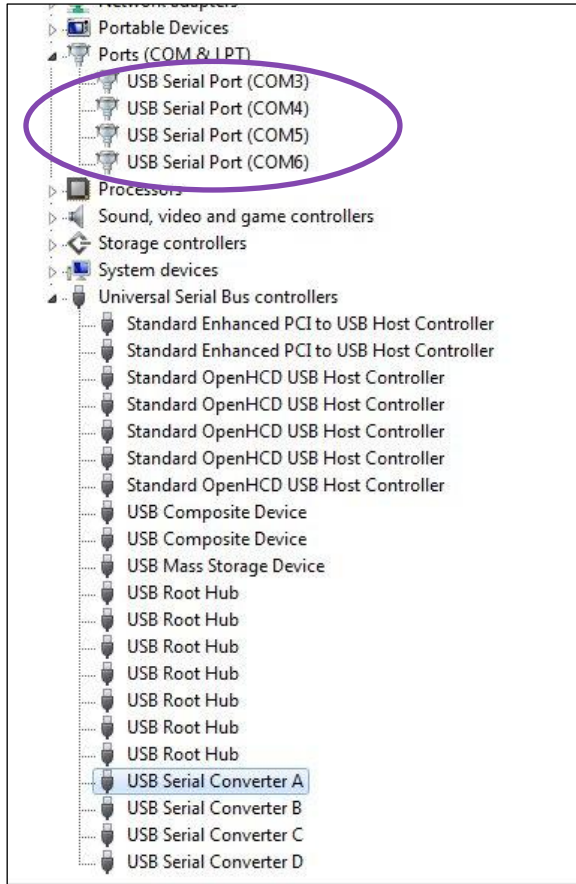

APPENDIX B: USING THE RN-ISP TO MEASURE THE POWER PROFILE

You can use the RN-ISP to measure the power profile of the application that is running on the WiFly module. This tool is very useful for plotting the current drawn by the module in different states, such as sleep, idle, and receiving and transmitting data.

To use this tool, you must have licensed the SDK from Roving Networks and installed it on a Linux computer. When the SDK is running on the development machine, follow these steps to start the power profile application:

1. Connect the RN_G2ISP to the development machine.
2. Connect the target board (RN-174 or RN-SDK) to the RN-ISP.
3. Open a command prompt on the development machine.
4. Go to the **SDK/release/tools/dcom_interface** directory.
5. Type **python g2isp_gui.py <cr>**. The power profile application launches as shown in Figure 11.

Figure 11. RN-ISP Power Profile Application

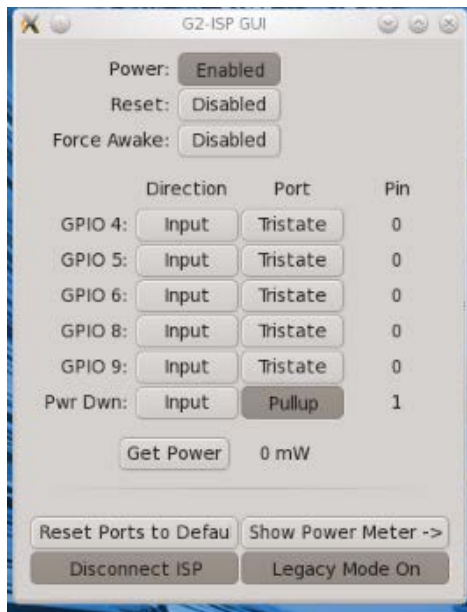

6. Click **Show Power Meter** to obtain a detailed interface.
7. Set the threshold value to start capturing the power profile.
8. Press the board's reset button to reload the application running on the WiFly module.
9. Press the board's wake button to wake the WiFly module from sleep.

To capture the power profile on the RN-ISP, press **Capture** in the power profile application. Figure 12 shows an example power profile.

Figure 12. Example Power Profile

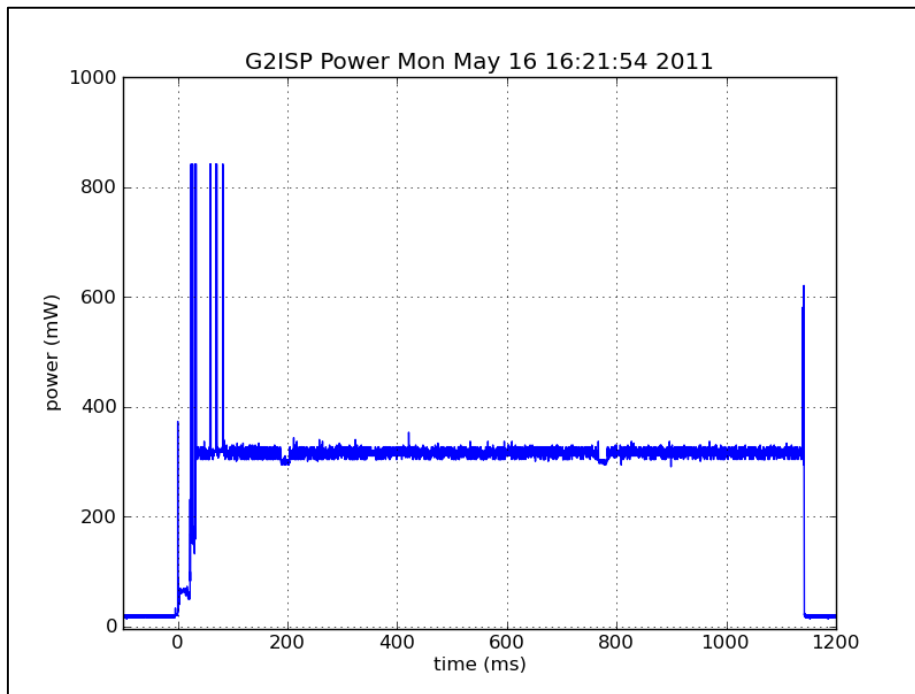

The power profile in Figure 12 shows the power consumed by the module in various states, such as sleep, wake up and load an application from flash, power on the transmitter to send data, put the transmitter in idle (receiving) mode, and go back to sleep.

The regions in Figure 12 is are:

- Start to 0 ms—The module is asleep.
- 0 to 10 ms—The module boots and loads the application into RAM from flash.
- 10 to 100 ms—The module is sending data and the the transmitter is on intermittently.
- 100 to 1,170 ms—The module is idle; it is associated with the access point and is in a receive state.
- 1,170 ms and onwards—The module is asleep.

FLASH LOADER UTILITY

It is sometimes convenient to load a binary image without installing and using the SDK. With the flash loader utility, you can flash the firmware onto the module using a PC. To use the flash loader utility, you must have the RN-ISP and a target board with a 16-pin debug header.

To set up the hardware, first, connect the target board to the RN-ISP using a 16-pin ribbon cable. Then, connect the RN-ISP to the PC using a USB cable.

Before using the flash loader utility, you must first locate the DMA COM port associated with the utility. The DMA port is usually the second highest of the four COM ports that are created for the ISP. For example, if the COM ports are labeled COM3, COM4, COM5, and COM6, COM 5 is the DMA port. See Figure 13.

Figure 13. COM Ports in Device Manager

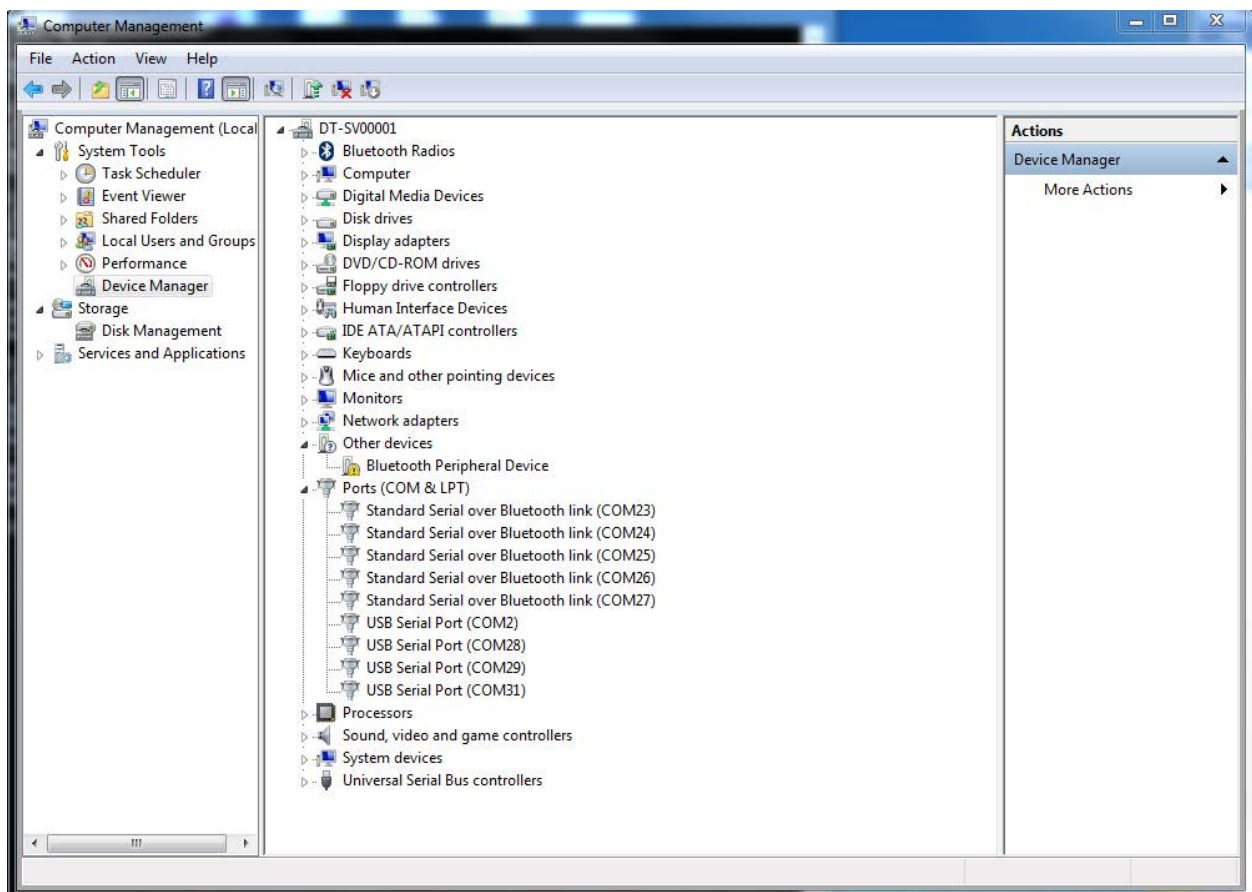

If the COM port is higher than 10, re-assign the DMA COM port to a number below 10 using the device manager. For example, to change COM31 to COM3 in Windows, perform the following steps:

1. Double click COM31 in the device manager under **Ports (COM & LPT)**. The **USB Serial Port (COM31) Properties** window opens. See Figure 14.

Figure 14. USB Serial Port (COM31) Properties Window

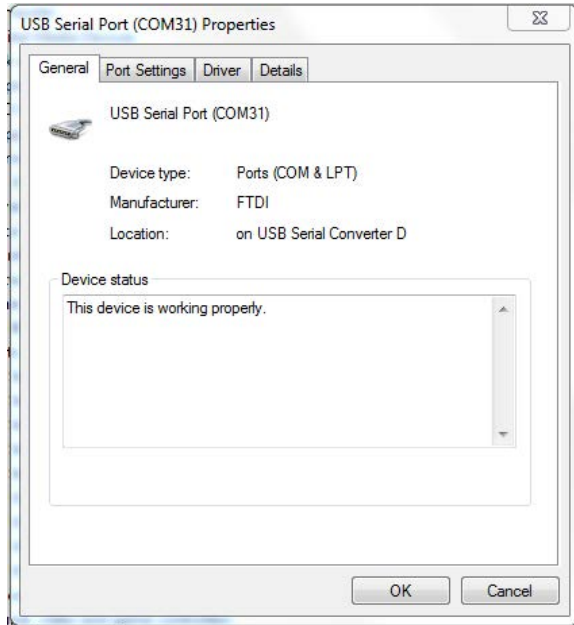

2. In the **USB Serial Port (COM31) Properties** window, click the **Port Settings** tab.
3. Click **Advanced**. Select **COM3** in the **COM Port Number** drop-down list box to change the COM port number to COM3. See Figure 15.

Figure 15. Advanced COM Port Settings

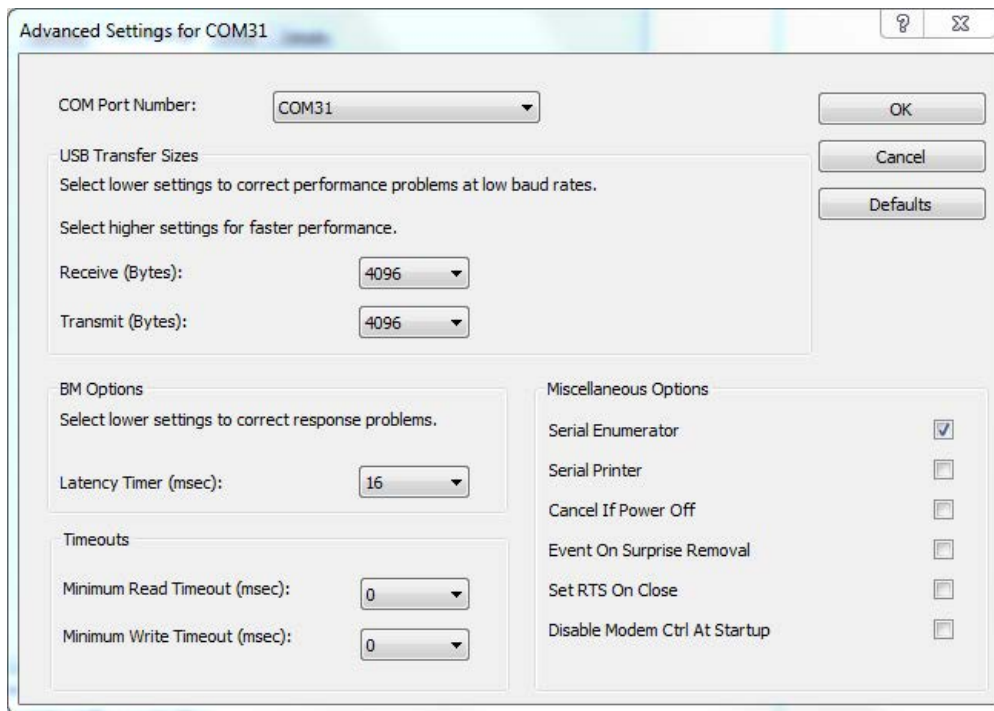

NOTE: If all ports from COM1 through COM10 are in use, follow the instructions in the COM port reset application note to clear out the COM ports. The application note is available on the Roving Networks Documentation & Resources web page at <http://www.rovingnetworks.com/resources/show/>.

To run the flash loader utility on a Windows PC, perform the following steps:

1. Open a command prompt window.
2. Change to the **flash_load_32** directory.
3. Ensure that the binary image file you want to load is in the same directory.
4. Type **flash_load -d /dev/com<number> -i <binary file name> -f <cr>**.

The binary image is loaded into the flash memory. See Figure 16.

Figure 16. Loading the Binary Image to Flash

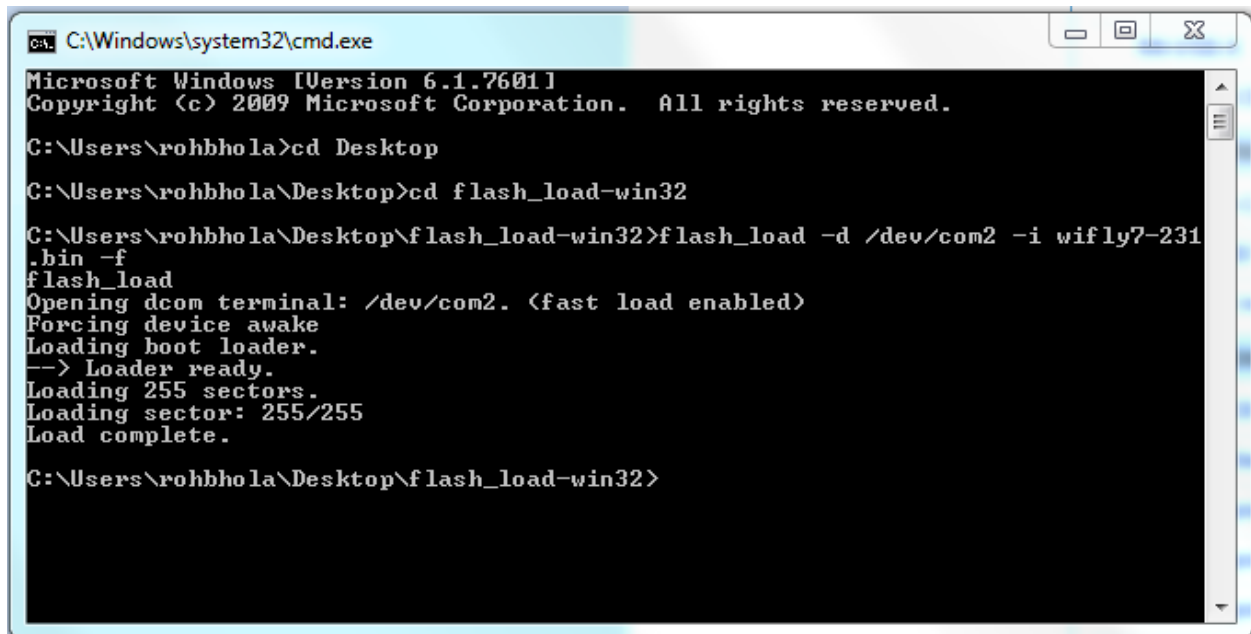

```

C:\Windows\system32\cmd.exe
Microsoft Windows [Version 6.1.7601]
Copyright (c) 2009 Microsoft Corporation. All rights reserved.

C:\Users\rohbhola>cd Desktop
C:\Users\rohbhola\Desktop>cd flash_load-win32
C:\Users\rohbhola\Desktop\flash_load-win32>flash_load -d /dev/com2 -i wifly7-231
.bin -f
flash_loader
Opening dcom terminal: /dev/com2. <fast load enabled>
Forcing device awake
Loading boot loader.
--> Loader ready.
Loading 255 sectors.
Loading sector: 255/255
Load complete.

C:\Users\rohbhola\Desktop\flash_load-win32>
  
```

APPENDIX D: LEGACY BOARD DIAGRAM

Figure 17 shows the components and pin description of a legacy version of the ISP.

Figure 17. Legacy ISP Components & Pin Description

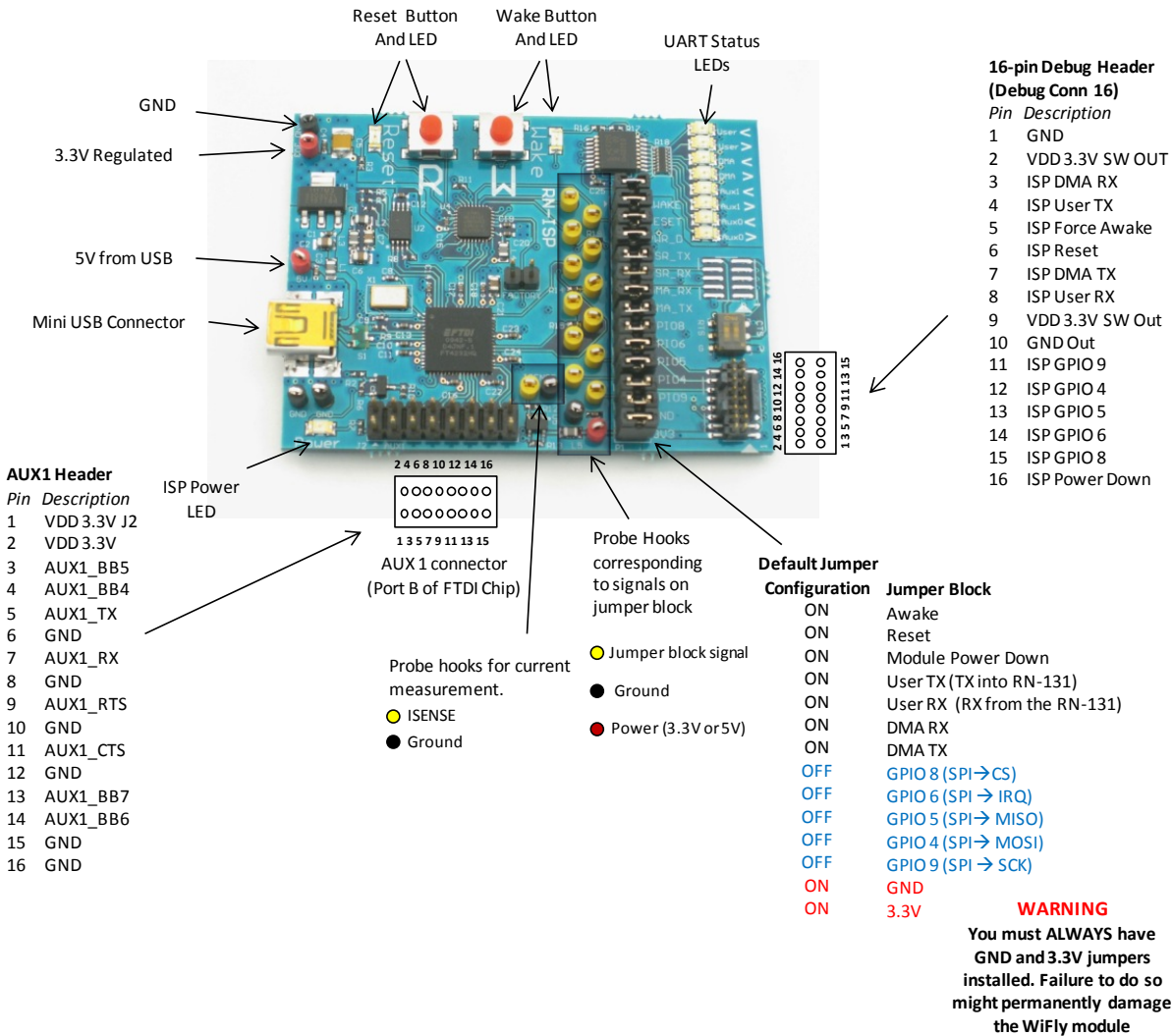

RESOURCES & RELATED DOCUMENTS

For more information, refer to the following sources, which are available on the Support page on the Roving Networks website at <http://www.rovingnetworks.com/support.php>:

- *RN-131 Data Sheet*
- *RN-134 Data Sheet*
- *RN-171 Data Sheet*
- *RN-174 Data Sheet*
- *Advanced User Manual*
- *COM Port Reset Application Note*
- <http://www.ftdichip.com/Drivers/VCP.htm> (FTDI drivers)

NOTES

Roving Networks, Inc.
102 Cooper Court
Los Gatos, CA 95032
+1 (408) 395-5300
www.rovingnetworks.com

Copyright © 2012 Roving Networks. All rights reserved. Roving Networks is a registered trademark of Roving Networks. Apple Inc., iPhone, iPad, iTunes, Made for iPhone are registered trademarks of Apple Computer.

Roving Networks reserves the right to make corrections, modifications, and other changes to its products, documentation and services at any time. Customers should obtain the latest relevant information before placing orders and should verify that such information is current and complete.

Roving Networks assumes no liability for applications assistance or customer's product design. Customers are responsible for their products and applications which use Roving Networks components. To minimize customer product risks, customers should provide adequate design and operating safeguards.

Roving Networks products are not authorized for use in safety-critical applications (such as life support) where a failure of the Roving Networks product would reasonably be expected to cause severe personal injury or death, unless officers of the parties have executed an agreement specifically governing such use.