

LT8643S 42V, 6A Synchronous Step-Down Silent Switcher 2

DESCRIPTION

Demonstration circuit 2658A is a 42V, 6A synchronous step-down second generation SILENT SWITCHER with spread spectrum frequency modulation featuring the LT[®]8643S. The demo board is designed for 5V output from a 5.8V to 42V input. The wide input range allows a variety of input sources, such as automotive batteries and industrial supplies. The LT8643S is a compact, ultralow emission, high efficiency, and high speed synchronous monolithic step-down switching regulator. The integrated bypass capacitors optimize all the fast current loops and make it easier to minimize EMI/EMC emissions by reducing layout sensitivity. Selectable spread spectrum mode can further improve EMI/EMC performance. Fast minimum on-time of 30ns enables high V_{IN} to low V_{OUT} conversion at high frequency.

The LT8643S switching frequency can be programmed either via oscillator resistor or external clock over a 200kHz to 3MHz range. The default frequency of demo circuit 2658A is 2MHz. The SYNC pin on the demo board is grounded (JP1 at BURST position) by default for low ripple burst mode operation. To synchronize to an external clock, move JP1 to SYNC and apply the external clock to the SYNC terminal. Spread spectrum mode and forced continuous mode can be selected respectively by moving JP1 shunt. Figure 1 shows the efficiency of the circuit at 12V input and 24V input in Burst Mode Operation (input from V_{IN} terminal to bypass the EMI filter). Figure 2 shows

the LT8643S temperature rising on DC2658A demo board under different load conditions. The rated maximum load current is 6A, while derating is necessary for certain input voltage and thermal conditions.

The demo board has an EMI filter installed. The EMI performance of the board (with EMI filter) is shown on Figure 3. The red line in Radiated EMI Performance is CISPR25 Class 5 peak limit. The figure shows that the circuit passes the test with a wide margin. To achieve EMI/EMC performance as shown in Figure 3, the input EMI filter is required and the input voltage should be applied at V_{IN_EMI} terminal. An inductor can be added in the EMI filter to further reduce the conducted emission. The EMI filter can be bypassed by applying the input voltage at V_{IN} terminal.

The LT8643S data sheet gives a complete description of the part, operation and application information. The data sheet must be read in conjunction with this demo manual for DC2658A. The LT8643S is assembled in a 4mm × 4mm LQFN package with exposed pads for low thermal resistance. The layout recommendations for low EMI operation and maximum thermal performance are available in the data sheet section Low EMI PCB Layout and Thermal Considerations and Peak Output Current.

Design files for this circuit board are available at <http://www.linear.com/demo/DC2658A>

LT, LT, LTC, LTM, Linear Technology and the Linear logo are registered trademarks of Linear Technology Corporation. All other trademarks are the property of their respective owners.

PERFORMANCE SUMMARY Specifications are at $T_A = 25^\circ\text{C}$

SYMBOL	PARAMETER	CONDITIONS	MIN	TYP	MAX	UNITS
V_{IN_EMI}	Input Supply Range with EMI Filter		5.8		42	V
V_{OUT}	Output Voltage		4.85	5	5.15	V
I_{OUT}	Maximum Output Current	Derating Is Necessary for Certain V_{IN} and Thermal Conditions	6			A
f_{SW}	Switching Frequency		1.85	2	2.15	MHz
EFF	Efficiency	$V_{IN} = 12\text{V}, I_{OUT} = 3\text{A}$		94.2		%

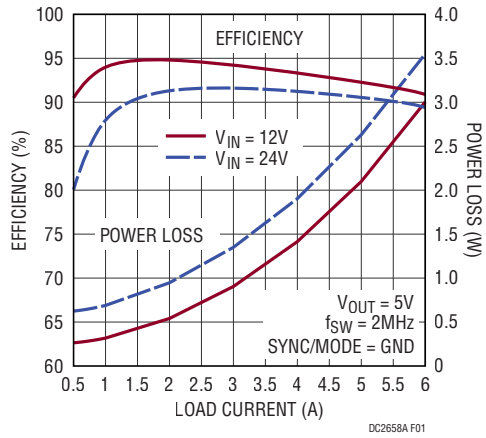

Figure 1. LT8643S DC2658A Efficiency vs Load Current (Input from VIN Terminal)

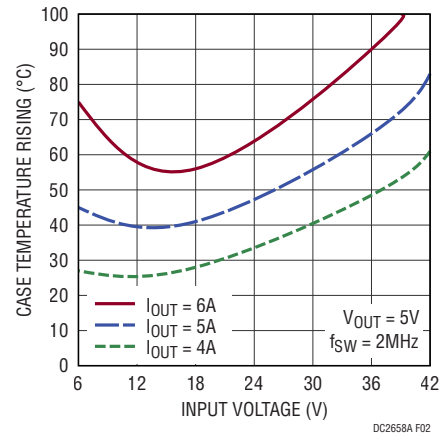
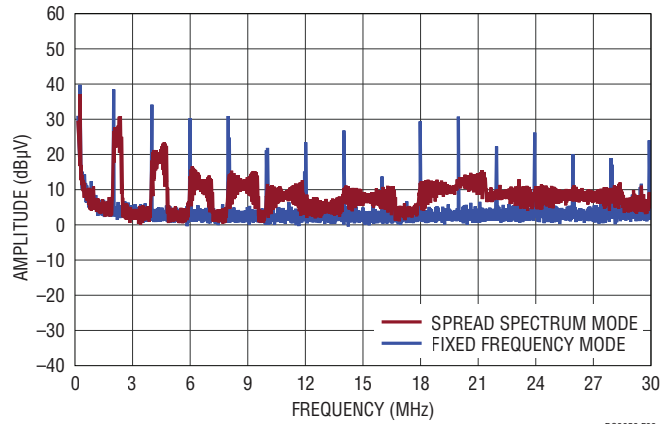

Figure 2. LT8643S DC2658A Case Temperature Rising vs Input Voltage

Conducted EMI Performance



(WITH EMI FILTER INSTALLED)
14V INPUT TO 5V OUTPUT AT 4A, $f_{SW} = 2\text{MHz}$

DC2658 F03a

Radiated EMI Performance (CISPR25 Radiated Emission Test with Class 5 Peak Limits)

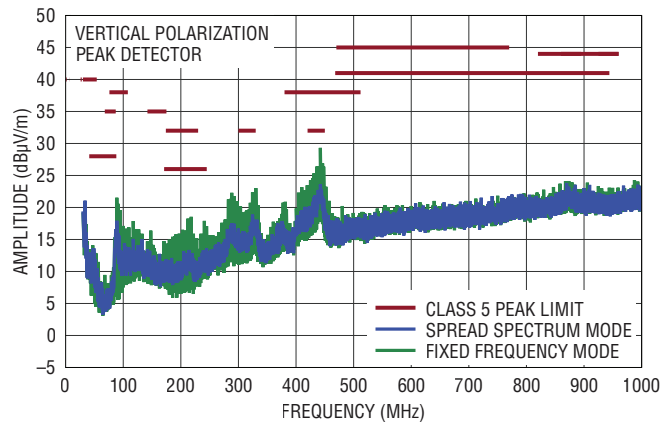

DC2658 F03b

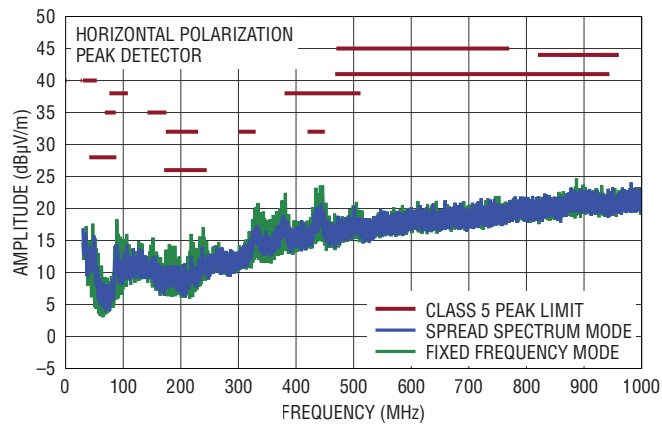

DC2658 F03c

(WITH EMI FILTER INSTALLED)
14V INPUT TO 5V OUTPUT AT 4A, $f_{SW} = 2\text{MHz}$

**Figure 3. LT8643S Demo Circuit DC2658A EMI Performance
(14V Input from V_{IN_EMI} , with EMI Filter, $I_{OUT} = 4\text{A}$)**

QUICK START PROCEDURE

Demonstration circuit 2658A is easy to set up to evaluate the performance of the LT8643S. Refer to Figure 4 for proper measurement equipment setup and follow the procedure below:

NOTE: When measuring the input or output voltage ripple, care must be taken to avoid a long ground lead on the oscilloscope probe. Measure the output voltage ripple by touching the probe tip directly across the output capacitor. See Figure 5 for the proper scope technique. Figure 6 shows the output voltage ripple measured at the output capacitor C9.

1. Place JP1 on BURST position.
2. With power off, connect the input power supply to VIN_EMI and GND. If the input EMI filter is not desired, connect the input power supply to V_{IN} and GND.
3. With power off, connect the load from V_{OUT} to GND.
4. Turn on the power at the input.

NOTE: Make sure that the input voltage does not exceed 42V.

5. Check for the proper output voltage ($V_{OUT} = 5V$).

NOTE: If there is no output, temporarily disconnect the load to make sure that the load is not set too high or is shorted.

6. Once the proper output voltage is established, adjust the load within the operating ranges and observe the output voltage regulation, ripple voltage, efficiency and other parameters.
7. An external clock can be added to the SYNC terminal when SYNC function is used (JP1 on the SYNC position). Please make sure that R2 should be chose to set the LT8643S switching frequency equal to or below the lowest SYNC frequency. JP1 can also set LT8643S in spread spectrum mode (JP1 on the SPREAD-SPECTRUM position) or forced continuous mode (JP1 on the FCM position).

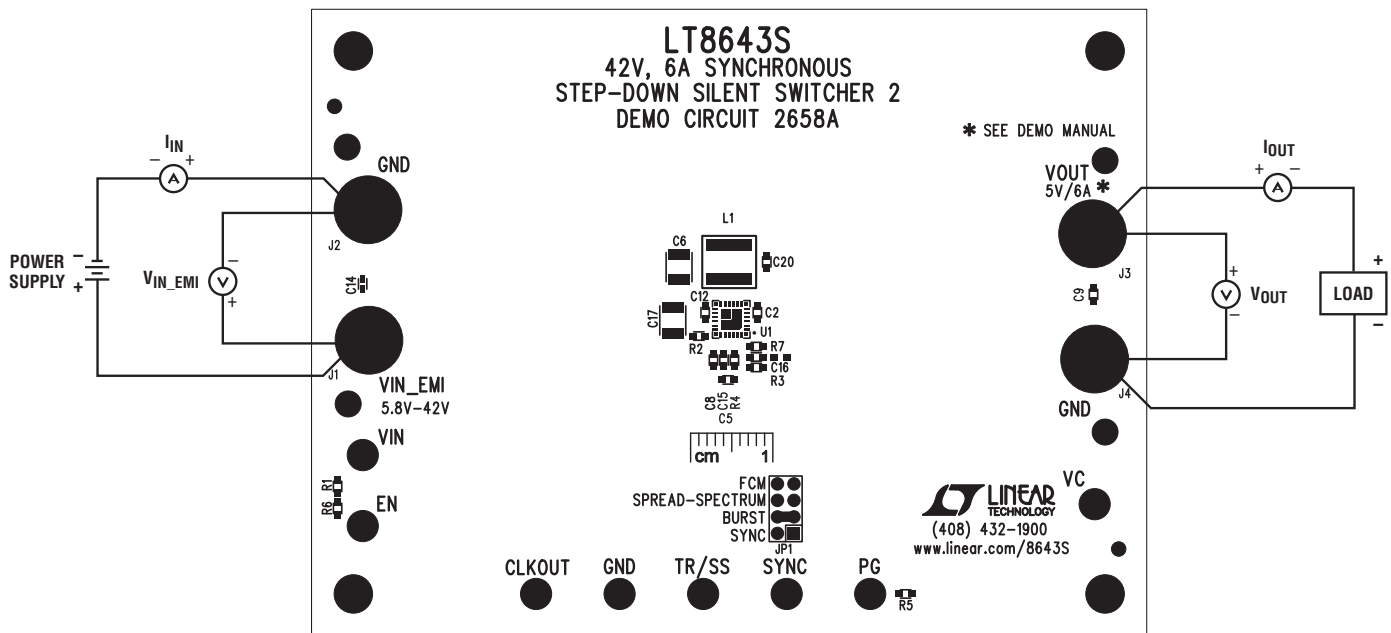

Figure 4. Proper Measurement Equipment Setup

QUICK START PROCEDURE

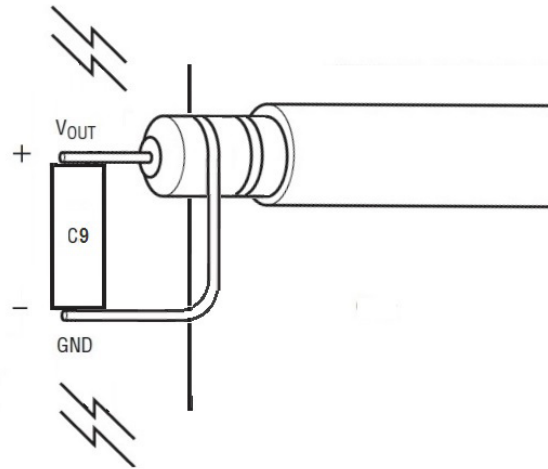

Figure 5. Measuring Output Ripple at Output Capacitor C9

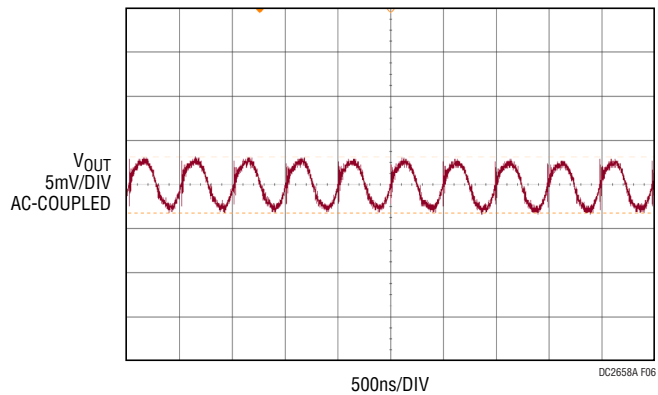

Figure 6. LT8643S Demo Circuit DC2658A Output Voltage Ripple (12V Input, $I_{OUT} = 6A$, Full BW)

DEMO MANUAL DC2658A

PARTS LIST

ITEM	QTY	REFERENCE	PART DESCRIPTION	MANUFACTURER/PART NUMBER
Required Circuit Components				
1	2	C2, C12	CAP., X5R, 1 μ F, 50V, 10%, 0603	MURATA, GRM188R61H105KAALD
2	1	C5	CAP., COG, 330pF, 50V, 5%, 0603	MURATA, GRM1885C1H331JA01D
3	1	C6	CAP., X5R, 100 μ F, 10V, 20% 1210	MURATA, GRM32ER61A107ME20L
4	1	C8	CAP., X7R, 0.1 μ F, 16V, 10%, 0603	MURATA, GRM188R71C104KA01D
5	1	C9	CAP., X5R, 22 μ F, 10V, 20%, 0603	SAMSUNG, CL10A226MPMNUBE
6	1	C16	CAP., COG, 4.7pF, 50V, \pm 0.1pF, 0603	MURATA, GRM1885C1H4R7BA01D
7	1	C17	CAP., X7R, 10 μ F, 50V, 10%, 1210	MURATA, GRM32ER71H106KA12L
8	1	C20	CAP., X7R, 1 μ F, 10V, 10%, 0603	MURATA, GRM188R71A105KA61D
9	1	L1	INDUCTOR, 1.5 μ H	COILCRAFT, XEL6030-152ME
10	2	R1, R5	RES., CHIP, 100k, 1/10W, 1% 0603	VISHAY, CRCW0603100KFKEA
11	1	R2	RES., CHIP, 17.8k, 1/10W, 1% 0603	VISHAY, CRCW060317K8FKEA
12	1	R3	RES., CHIP, 243k, 1/10W, 1%, 0603	VISHAY, CRCW0603243KFKEA
13	1	R4	RES., CHIP, 8.45k, 1/10W, 1%, 0603	VISHAY, CRCW06038K45FKEA
14	1	R7	RES., CHIP, 1M, 1/10W, 1%, 0603	VISHAY, CRCW06031M00FKEA
15	1	U1	I.C., STEP-DOWN SWITCHER, 4mm \times 4mm LQFN	LINEAR TECH., LT8643SEV#PBF
Additional Demo Board Circuit Components				
1	1	C1	CAP., ALUM 22 μ F, 63V	SUN ELECT., 63CE22BS
2	2	C3, C10	CAP., X7R, 10 μ F, 50V, 10%, 1210	MURATA, GRM32ER71H106KA12L
3	2	C14, C21	CAP., X7R, 0.1 μ F, 50V, 10%, 0402	MURATA, GRM155R71H104KE14D
4	0	C15, C18 (OPT)	CAP., OPTION, 0603	
5	1	FB1	BEAD, FERRITE, 100 Ω , 1812	WURTH ELEKTRONIK, 74279226101
6	0	R6 (OPT)	RES., OPTION, 0603	
7	1	R8	RES., CHIP, 0 Ω , 1/10W, 1%, 0603	VISHAY, CRCW06030000Z0EA
Hardware: For Demo Board Only				
1	8	E1, E5-E9, E11, E14	TESTPOINT, TURRET, .094"	MILL-MAX, 2501-2-00-80-00-00-07-0
2	4	E2, E10, E12, E13	TESTPOINT, TURRET, .064"	MILL-MAX, 2308-2-00-80-00-00-07-0
3	1	JP1	2 \times 4, 0.079 DOUBLE ROW HEADER	WURTH ELEKTRONIK, 62000821121
4	1	XJP1	SHUNT, .079" CENTER	WURTH ELEKTRONIK, 60800213421
5	4	J1-J4	JACK BANANA	KEYSTONE, 575-4
6	4	MH1-MH4	STAND-OFF, NYLON 0.50" TALL	WURTH ELEKTRONIK, 702935000

SCHEMATIC DIAGRAM

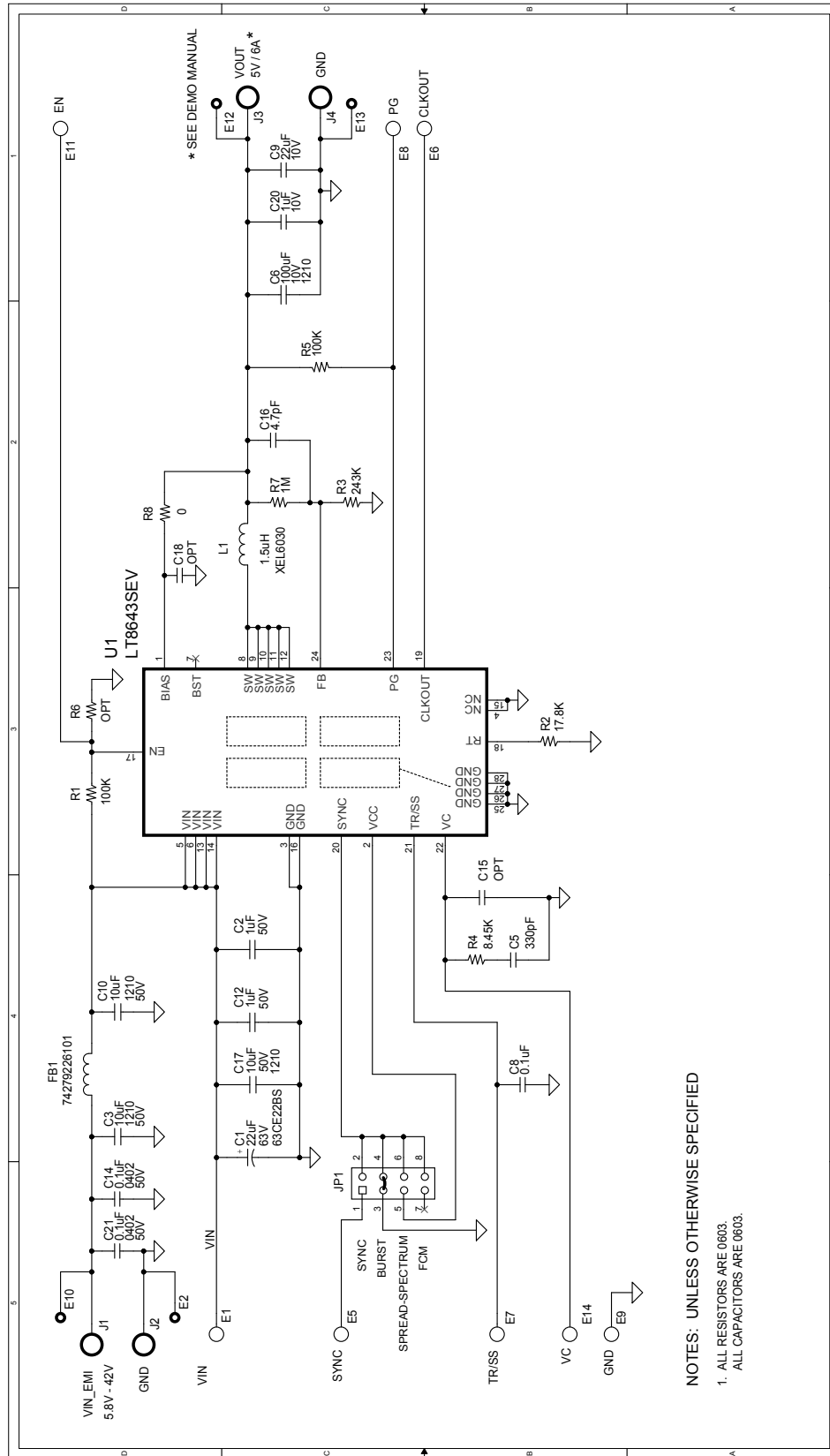

DEMO MANUAL DC2658A

DEMONSTRATION BOARD IMPORTANT NOTICE

Linear Technology Corporation (LTC) provides the enclosed product(s) under the following **AS IS** conditions:

This demonstration board (DEMO BOARD) kit being sold or provided by Linear Technology is intended for use for **ENGINEERING DEVELOPMENT OR EVALUATION PURPOSES ONLY** and is not provided by LTC for commercial use. As such, the DEMO BOARD herein may not be complete in terms of required design-, marketing-, and/or manufacturing-related protective considerations, including but not limited to product safety measures typically found in finished commercial goods. As a prototype, this product does not fall within the scope of the European Union directive on electromagnetic compatibility and therefore may or may not meet the technical requirements of the directive, or other regulations.

If this evaluation kit does not meet the specifications recited in the DEMO BOARD manual the kit may be returned within 30 days from the date of delivery for a full refund. **THE FOREGOING WARRANTY IS THE EXCLUSIVE WARRANTY MADE BY THE SELLER TO BUYER AND IS IN LIEU OF ALL OTHER WARRANTIES, EXPRESSED, IMPLIED, OR STATUTORY, INCLUDING ANY WARRANTY OF MERCHANTABILITY OR FITNESS FOR ANY PARTICULAR PURPOSE. EXCEPT TO THE EXTENT OF THIS INDEMNITY, NEITHER PARTY SHALL BE LIABLE TO THE OTHER FOR ANY INDIRECT, SPECIAL, INCIDENTAL, OR CONSEQUENTIAL DAMAGES.**

The user assumes all responsibility and liability for proper and safe handling of the goods. Further, the user releases LTC from all claims arising from the handling or use of the goods. Due to the open construction of the product, it is the user's responsibility to take any and all appropriate precautions with regard to electrostatic discharge. Also be aware that the products herein may not be regulatory compliant or agency certified (FCC, UL, CE, etc.).

No License is granted under any patent right or other intellectual property whatsoever. **LTC assumes no liability for applications assistance, customer product design, software performance, or infringement of patents or any other intellectual property rights of any kind.**

LTC currently services a variety of customers for products around the world, and therefore this transaction **is not exclusive**.

Please read the DEMO BOARD manual prior to handling the product. Persons handling this product must have electronics training and observe good laboratory practice standards. **Common sense is encouraged.**

This notice contains important safety information about temperatures and voltages. For further safety concerns, please contact a LTC application engineer.

Mailing Address:

Linear Technology
1630 McCarthy Blvd.
Milpitas, CA 95035

Copyright © 2004, Linear Technology Corporation