

# SpectraBright Series

## 0606 Package Size

### SMD RGB and Bi-Color LEDs

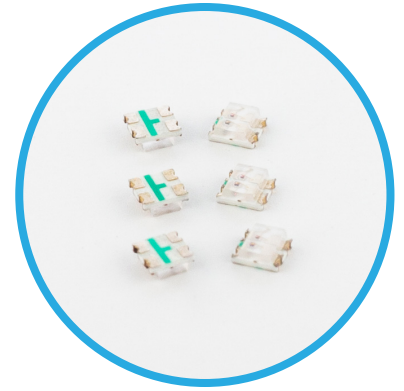

Space-Saving, Multi-Status Indication and Multicolor/Brightness Options Enhance Design Possibilities.



#### Application

- Automated Guided Vehicles
- EV Charging Stations
- Navigations Systems
- Industrial Controls
- IoT/Smart Home Systems
- Medical Devices
- Mil-Aero
- Telecom
- Status Indicator

#### Key Features

- Package size 0606
- Tape and reel packaged for high-speed auto insertion
- Through-hole, SMD
- Clear lens
- Tri-color: RGB
- Bi-color: Red/Green
- Enjoy high visibility in a range of working environments thanks to a wide, 120° viewing angle
- High and low intensity options available. Mcd ranging from 15 to 160 mcd
- For custom LED color contact VCC
- MIL-STD-750 D:1026, and MIL-STD-883 D:1005 Standards
- RoHS, REACH Compliant

## Ordering Data

Part Number	Color	Brightness	Lens Type	Viewing Angle (deg)	Mil	Size L x W (mm)	Height (mm)
SB0606WC01-RGB	RGB	High	Water Clear	120	1616	1.6 x 1.6	0.6
SB0606WC02-RGB	RGB	Low	Water Clear	120	1616	1.6 x 1.6	0.6
SB0606WC01-RG	Red/Green	High	Water Clear	120	1616	1.6 x 1.6	0.6

# Product Dimensions

## SB0606WC01-RG

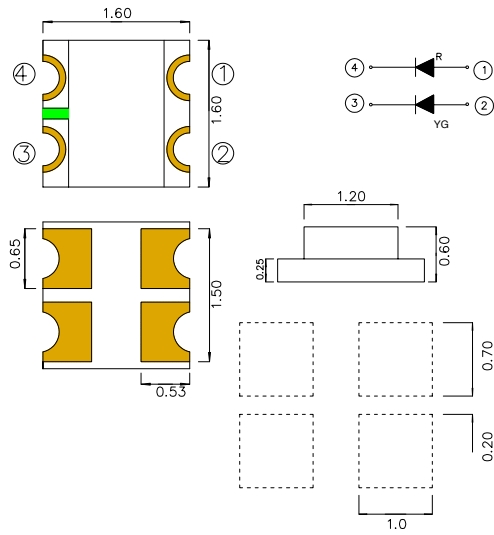

## SB0606WC02-RGB

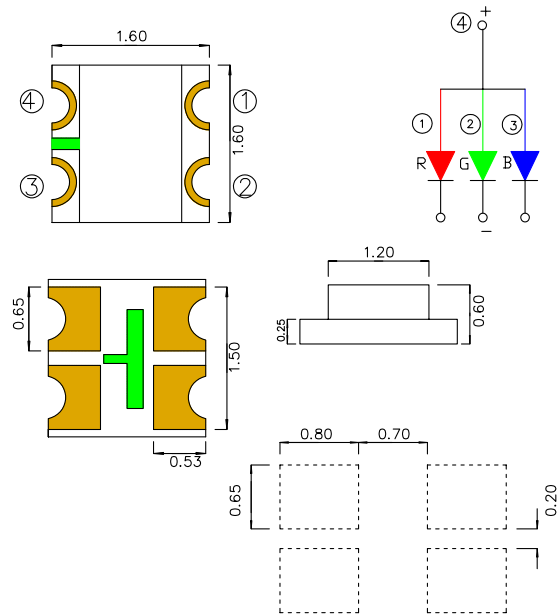

## SB0606WC01-RGB

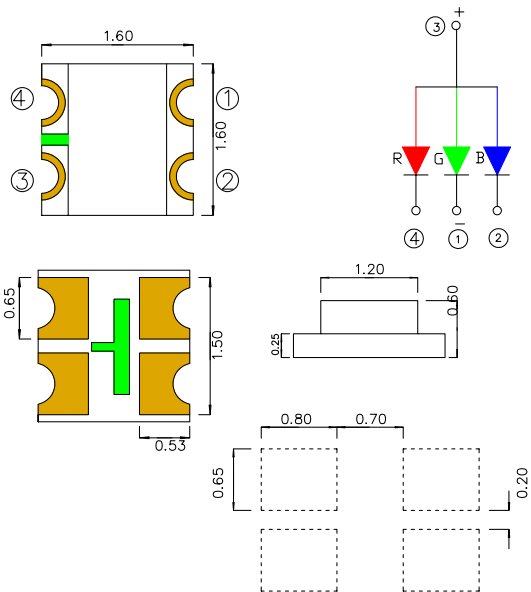

### Notes:

1. All dimensions are in mm
2. Tolerance is  $\pm 0.1$  mm unless otherwise noted
3. The specifications, characteristics and technical data described in the datasheet are subject to change without prior notice.

## Product Specifications

Part Number	Color	Dominant Wavelength (nm) @ IF=20mA	Luminous Intensity (mcd) IF=20mA	Forward Voltage (Vf) @ If=20mA	Viewing Angle (deg)
SB0606WC01-RGB	RGB	R=635, G=518, B=460	R=160, G=600, B=125	R=2V, G=3V, B=3V	120
SB0606WC02-RGB	RGB	R=635, G=518, B=460	R=35, G=75, B=20	R=3V, G=3V, B=3V	120
SB0606WC01-RG	Red/Green	R=625, G=568	R=160, G=40	R=2V, G=2V	120

# Product Specifications

## SB0606WC01-RG

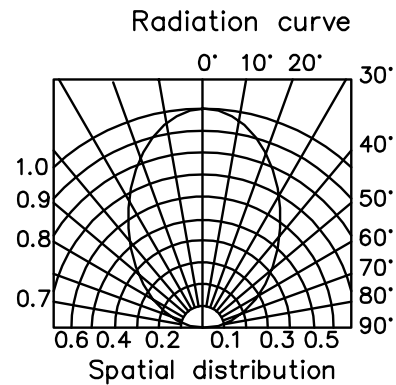
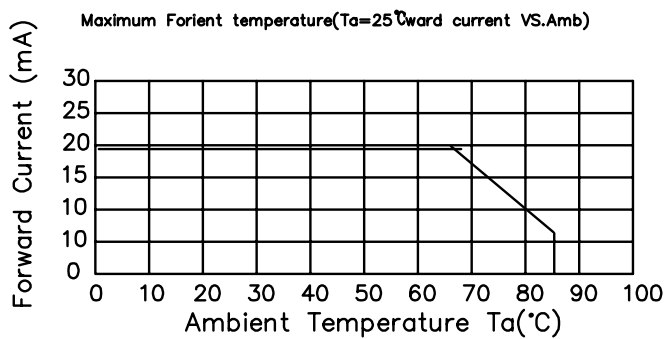
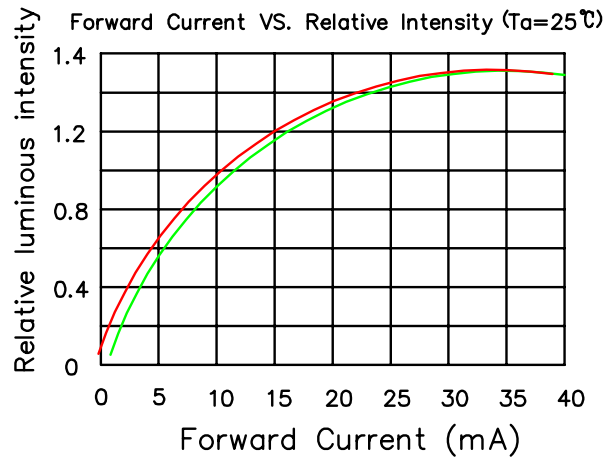
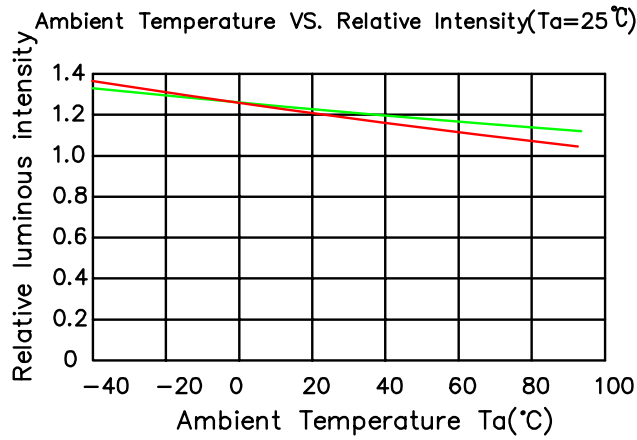
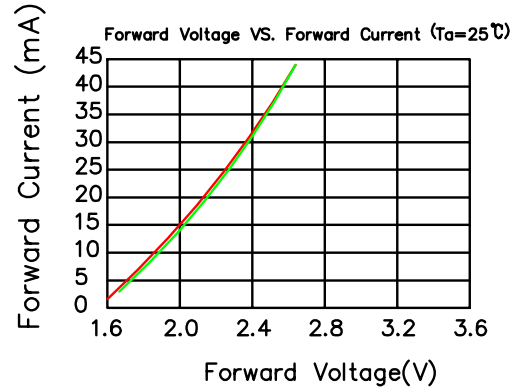
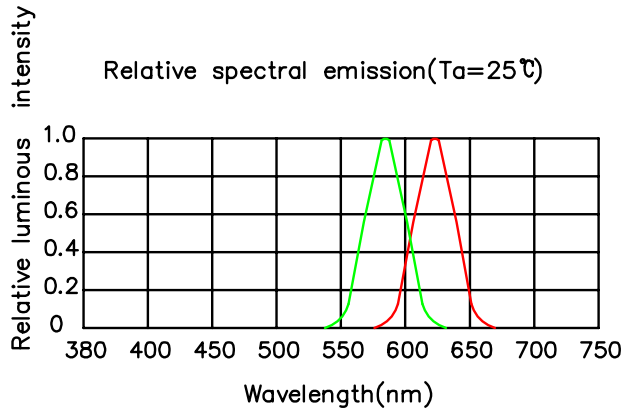

# Product Specifications

## SB0606WC02-RGB

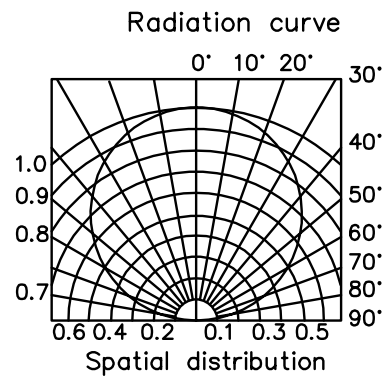
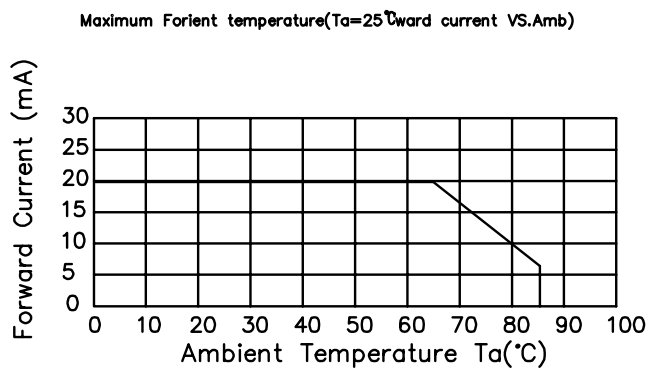
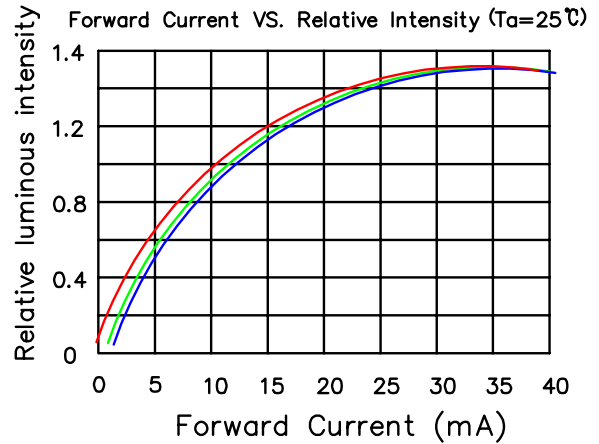
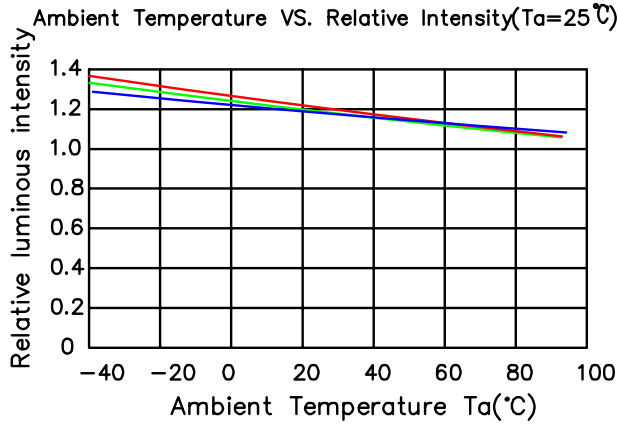
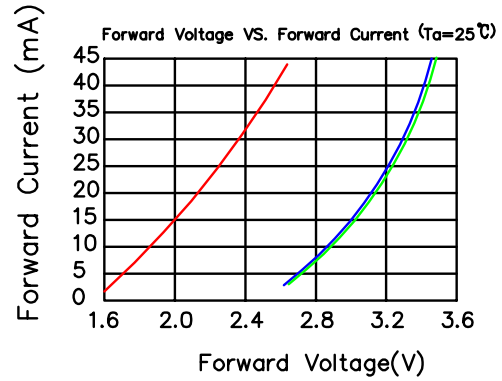
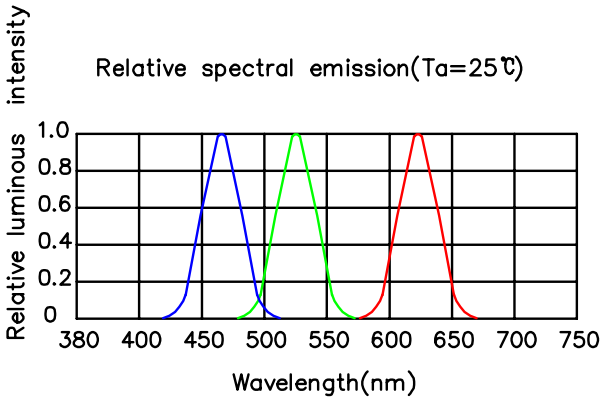

# Product Specifications

## SB0606WC01-RGB

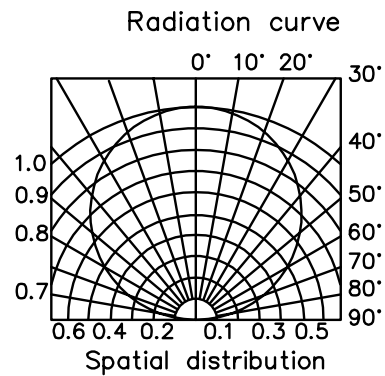
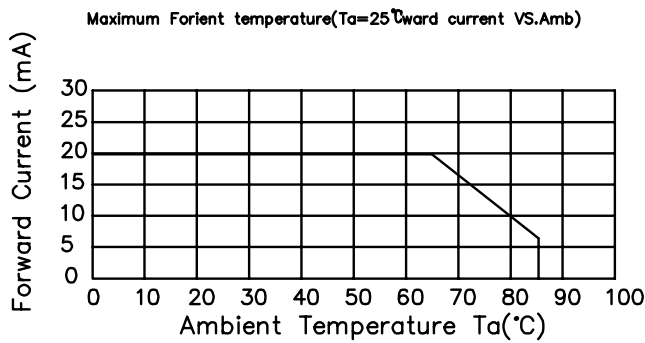
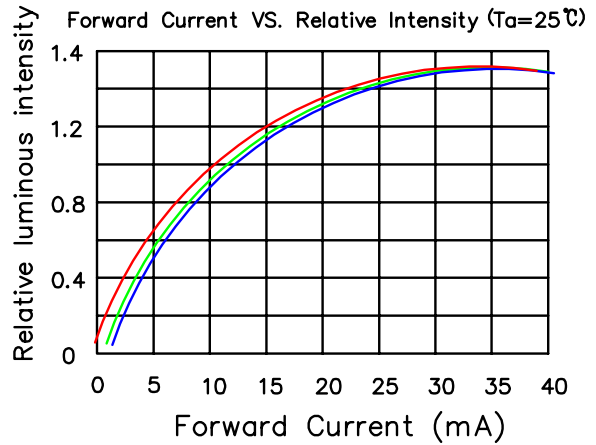
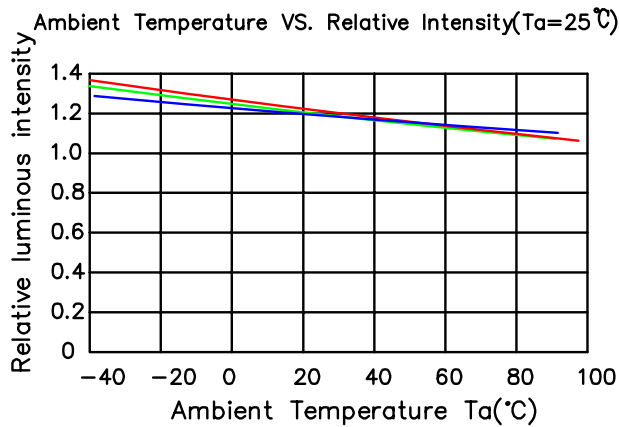
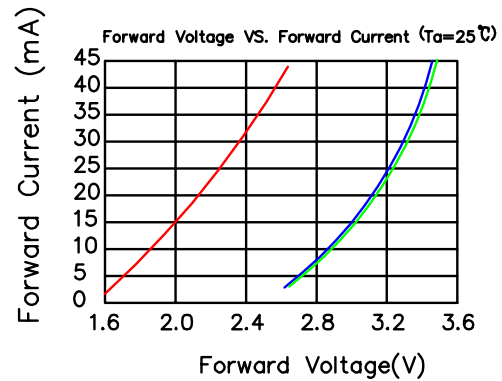
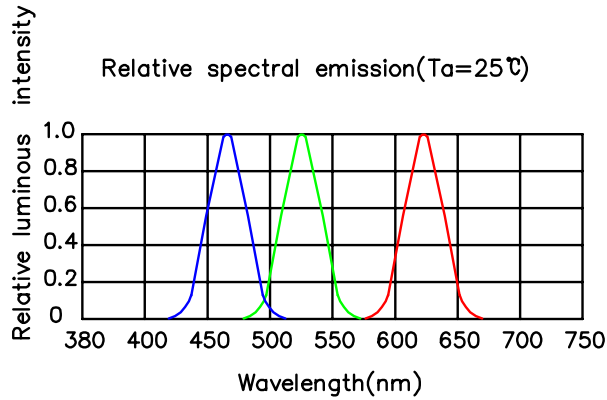

# Precautions

## Reliability Test

Classification	Test Item	Test Condition	Test Time	Reference Standard
Endurance Test	Operation Life	25ma Ta= Under Room Temperature As Per Datasheet Maximum Rating	1000 HRS (-24 HRS, +72 HRS)	MIL-STD-750 D:1026 MIL-STD-883 D:1005
	High Temperature, High Humidity Storage	IR-Reflow In-Board, 2 Times Ta=85? °C RH=85%IR-Reflow In-Board, 2 Times Ta=85? °C RH=85%	1000 HRS (±2 HRS)	JESD22-A101
	High Temperature Storage	Ta=105±5°C	1000 HRS (-24 HRS, +72 HRS)	MIL-STD-883 D:1008 JIS C 7021:B-10
	Low Temperature Storage	Ta=-40±5°C	1000 HRS (-24 HRS, +72 HRS)	JIS C 7021:B-10
	Temperature Cycling	100°C ~ 25°C ~ -40°C ~ 25°C 30mins 5mins 30mins 5mins	100/Cycles	MIL-STD-202F:107D MIL-STD-750D:1051
	Thermal Shock	IR-Reflow In-Board, 2 Times 100 ± 5°C ~ -40°C ± 5°C 10mins 10mins	100/Cycles	MIL-STD-202F:107D MIL-STD-750D:1051
	ReflowPb Free Process	260°C: 10 Peak temperature range 260°C 10s max	-----	MIL-STD-750 D:2031.2 J-STD-020C

## Soldering Profile

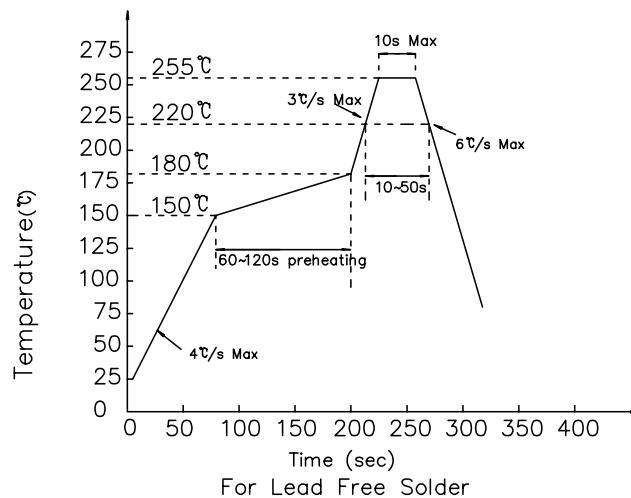



## Precautions

### Soldering

- Reflow soldering should not be done more than 2 times.
- Manual soldering is only suggested on repair and rework. The maximum soldering temperature should not exceed 300°C within 3 sec. And the maximum capacity of soldering iron is 30W in power.
- During the soldering process, do not touch the lens at high temperature.
- After soldering, any mechanical force on the lens or any excessive vibration shall not be accepted to apply, also the circuit board shall not be bent as well.

### Application

- A LED is a current-operated device. The slight shift of voltage will cause big change of current, which will damage LEDs. Customer should use resistors in series for the Over-Current-Proof.
- In order to ensure intensity uniformity on multiple LEDs connected in parallel in an application, it is recommended to use individual resistor separately, as shown in Circuit A below. The brightness of each LED shown in Circuit B might appear difference due to the differences in the I-V characteristics of those LEDs

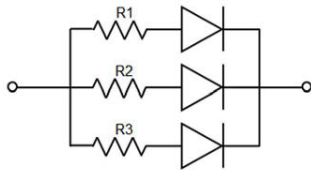

Circuit model A

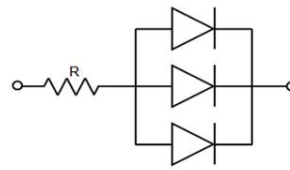

Circuit model B

- High temperature may reduce LEDs' intensity and other performances, so keeping it away from heat source to get good performance is necessary.

### Rank Tolerance

REF / VF:  $\pm 0.02V$

CAT / IV:  $\pm 10\%$

X / Y:  $\pm 0.005$

### Storage

- Before opening original package, it is recommended to store them in the following environment: Temperature: 5°C~30°C, Humidity: 85%RH max. When the inventory over 3 months, Should be done before treatment using dehumidification, Temperature: 60°C/8 hours.
- 5~ 30°C ; 60% after opening original package, the storage ambient for the LEDs should be in 5~30°C temperature and 60% or less relative humidity.
- In order to avoid moisture absorption, it is recommended that the LEDs that out of the original package should be stored in a sealed container with appropriate desiccant, or in desiccators with nitrogen ambient.
- The LEDs should be used within 168hrs (7days) after opening the package. Once been mounted, soldering should be quick.
- If the moisture absorbent material (silica gel) has faded away or the LEDs stored out of original package for more than 168hrs (7 days), baking treatment should be performed using the conditions: 60°C at least 24 hours.

## Tape and Reel Specifications

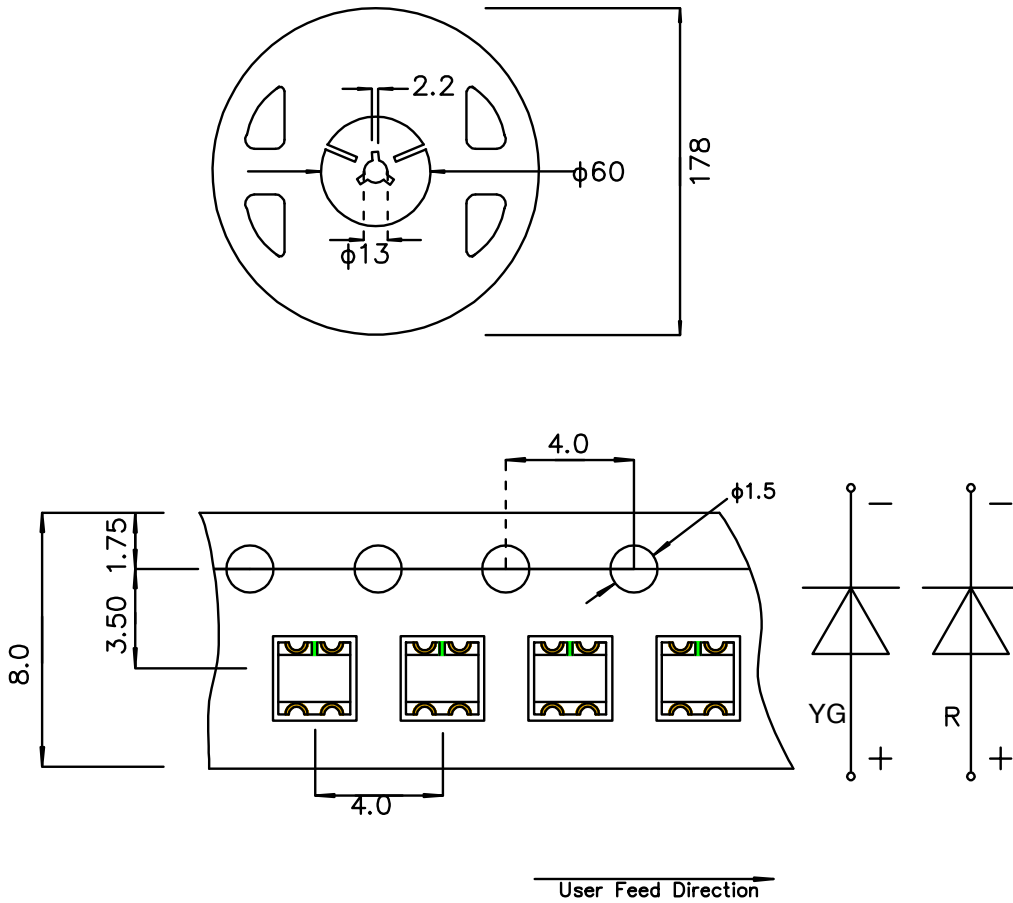

4000 pieces per reel

### Notes:

1. All dimensions are in mm
2. Tolerance is  $\pm 0.1$  mm unless otherwise noted
3. The specifications, characteristics and technical data described in the datasheet are subject to change without prior notice.

## Compliances and Approvals

