

Datasheet

Self-Contained Indicator for Bin-Picking Operations

To view or download the latest technical information about this product, including specifications, dimensions, accessories, and wiring, see www.bannerengineering.com.

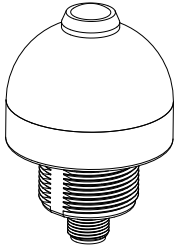

- Rugged, cost-effective and easy-to-install solutions for error-proofing and parts verification applications
- Compact devices are completely self-contained — no controller needed
- Illuminated dome provides a big, easy-to-see green job light, some models also light red for alternate operation
- Push-button and passive-actuation models available
- Fully encapsulated IP67 construction — ideal for use in abusive environments rated to IP69K, depending on installation
- Immune to ambient light, EMI and RFI interference
- AS-i module compatible
- 12 V dc to 30 V dc operation



WARNING: Not To Be Used for Personnel Protection

Never use this device as a sensing device for personnel **protection**. Doing so could lead to serious injury or death. This device does not include the self-checking redundant circuitry necessary to allow its use in personnel safety applications. A sensor failure or malfunction can cause either an energized or de-energized sensor output condition.

Standard Models - Single Color

- Job light is ON at all times while job input is active
- Presence of hand (or pressing push button) activates output

Model	Sensing Mode / LED	Housing	Range	Connection ¹	Output ²	Job Light	
K50APLPGXDQ	Polarized retroreflective, visible red, 680 nm	50 mm dome 30 mm mount polycarbonate	2 m (6 ft)	Integral 4-pin M12/Euro-style QD	PNP, N.O.	Green	
K50RPLPGXDQ					PNP, N.C.		
K50ANLPGXDQ					NPN, N.O.		
K50RNLPGXDX					NPN, N.C.		
K50APFF50GXDX	Fixed field, infrared, 880 nm		50 mm cutoff		100 mm cutoff		PNP, N.O.
K50RPFF50GXDX							PNP, N.C.
K50ANFF50GXDX							NPN, N.O.
K50RNFF50GXDX							NPN, N.C.
K50APFF100GXDX							PNP, N.O.
K50RPFF100GXDX							PNP, N.C.
K50ANFF100GXDX							NPN, N.O.
K50RNFF100GXDX							NPN, N.C.
K50APPBGXDQ	Push button	—	—	PNP, N.O.			

¹ Integral 4-pin M12/Euro-style quick disconnect models are listed.

- To order the 2 m (6.5 ft) PVC cable model, omit the suffix "Q" in the model number. For example, K50APLPGXD.
- To order the 9 m (30 ft) PVC cable model, add the suffix "W/30" to the cabled model number. For example, K50APLPGXD W/30.
- To order the 150 mm (6 in) PVC cable model with a 4-pin M12/Euro-style quick disconnect, replace the suffix "Q" with "QP" in the model number. For example, K50APLPGXDQP.
- Models with a quick disconnect require a mating cordset.

² N.O. = Normally Open; N.C. = Normally Closed



Model	Sensing Mode / LED	Housing	Range	Connection ¹	Output ²	Job Light
K50RPPBGXDQ					PNP, N.C.	
K50ANPBGXDQ					NPN, N.O.	
K50RNPBGXDQ					NPN, N.C.	

Specialty C-Series — Two-Color Models, 12 V dc to 30 V dc

- Job light is green while the job input is active (unless a hand is present)
- Presence of hand (or pressing push button) activates output and overrides job light (turns red) for visual verification that action was sensed
- Retroreflective models: To simplify alignment, the sensor provides a red signal when the retroreflective target is incorrectly aligned

Model	Sensing Mode / LED	Range	Cable ¹	Output ²	Job Light
K50RPLPGRCQ	Polarized retroreflective, Visible red, 680 nm	2 m (6 ft)	Integral 4-pin M12/ Euro-style QD	PNP, N.C.	Green (Red)
K50RNLPGRQCQ				NPN, N.C.	
K50APFF50GRCQ	Fixed-field, Infrared, 880 nm	50 mm cutoff		PNP, N.O.	
K50ANFF50GRCQ				NPN, N.O.	
K50APFF100GRCQ		100 mm cutoff		PNP, N.O.	
K50ANFF100GRCQ				NPN, N.O.	
K50APPBGRCQ	Push button	—		PNP, N.O.	
K50ANPBGRCQ				NPN, N.O.	

Specialty E-Series — Two-Color Models

- Job light is green at all times while job input is active
- Presence of hand (or pressing push button) activates output
- Presence of hand (or pressing push button) while job input is inactive causes unit to light red, for visual verification that sensor is functioning properly

Model	Sensing Mode / LED	Range	Cable ¹	Output ²	Job Light
K50RPLPGREQ	Polarized retroreflective, visible red, 680 nm	2 m (6 ft)	Integral 4-pin M12/Euro- style QD	PNP, N.C.	Green (Red)
K50RNLPGREQ				NPN, N.C.	
K50APFF50GREQ	Fixed field infrared, 880 nm	50 mm cutoff		PNP, N.O.	
K50ANFF50GREQ				NPN, N.O.	
K50APFF100GREQ		100 mm cutoff		PNP, N.O.	
K50ANFF100GREQ				NPN, N.O.	
K50APPBGREQ	Push button	—		PNP, N.O.	
K50ANPBGREQ				NPN, N.O.	

¹ Integral 4-pin M12/Euro-style quick disconnect models are listed.

- To order the 2 m (6.5 ft) PVC cable model, omit the suffix "Q" in the model number. For example, K50APLPGXD.
- To order the 9 m (30 ft) PVC cable model, add the suffix "W/30" to the cabled model number. For example, K50APLPGXD W/30.
- To order the 150 mm (6 in) PVC cable model with a 4-pin M12/Euro-style quick disconnect, replace the suffix "Q" with "QP" in the model number. For example, K50APLPGXDQP.
- Models with a quick disconnect require a mating cordset.

² N.O. = Normally Open; N.C. = Normally Closed

Installation

For push-button models, install the sensor at such a height and in a location that will be easy for the user and/or supervisor to see the indicator and will be comfortable for the user to press the push-button.

For other models, install the sensor in a location that will be comfortable for the user to break the beam when reaching for the required part. When multiple sensors will be located in close proximity, to monitor multiple bins for example, mount all the sensors in a similar sensing position (all mounted at the tops of the bins and pointing down, for example). This may reduce potential optical crosstalk, where one sensor detects another sensor's beam.

Wiring Diagrams

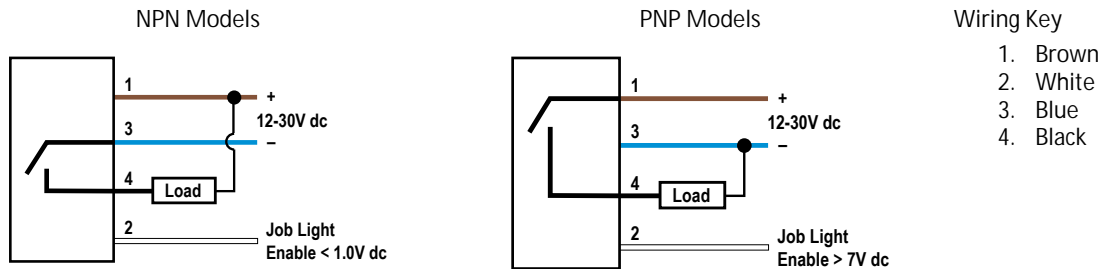

Note: Cabled wiring diagrams are shown. Quick disconnect (QD) wiring diagrams are functionally identical.

Specifications

Supply Voltage and Current

- 12 V dc to 30 V dc
- < 75 mA max current at 12 V dc (exclusive of load)
- < 40 mA max current at 30 V dc (exclusive of load)
- AS-i compatible

Supply Protection Circuitry

Protected against reverse polarity and transient voltages (fast-transient and overvoltage)

Output Configuration

PNP or NPN, depending on model

Output Rating

- Maximum load: 150 mA
- OFF-state leakage current: <math>< 10\ \mu A</math> at 30 V dc
- ON-state saturation voltage: <math>< 2\ V\ dc</math> at 10 mA; <math>< 2.5\ V\ dc</math> at 150 mA

Output Protection Circuitry

Protected against output short-circuit, continuous overload, and false pulse on power-up

Output Response Time

3 milliseconds On and Off

Power-Up Output Delay Time

300 milliseconds

Job Light Enable Input

- Input impedance: 8000 ohms
- PNP Input low <math>< 1.5\ V</math>
- NPN Input high > 7 V

Construction

- Base: polycarbonate
- Translucent dome: polycarbonate
- Push button: thermoplastic
- Lense: polycarbonate or acrylic

Connections

Depending on model: 4-wire, 2 m (6.5 ft) integral cable; 4-pin M12/Euro-style quick disconnect fitting; 150 mm PVC cable with quick disconnect; accessory cordset required for QD models

Ambient Light Immunity

Up to 5,000 lux

EMI-RFI Immunity

Immune to EMI and RFI noise sources, per IEC 947-5-2

Indicators

Entire translucent dome provides indicator light; either job or pick sensed indicator inhibits the other light, depend on model
 Job (pick) indicator: Green
 Pick sensed indicator: Red or unilluminated, depending on model

Environmental Rating

Fully encapsulated; IEC IP67
 Integral QD models: DIN 40050 (IP69K) when using IP69K-rated cables
 Cable models: IP69K when mounted with conduit
 NEMA/UL Type 4X, 13

Operating Conditions

-40 °C to +50 °C (-40 °F to +122 °F)
 90% at +50 °C maximum relative humidity (non-condensing)

Certifications



Required Overcurrent Protection



WARNING: Electrical connections must be made by qualified personnel in accordance with local and national electrical codes and regulations.

Overcurrent protection is required to be provided by end product application per the supplied table.
 Overcurrent protection may be provided with external fusing or via Current Limiting, Class 2 Power Supply.
 Supply wiring leads < 24 AWG shall not be spliced.
 For additional product support, go to www.bannerengineering.com.

Supply Wiring (AWG)	Required Overcurrent Protection (Amps)
20	5.0
22	3.0
24	2.0
26	1.0
28	0.8
30	0.5

Dimensions

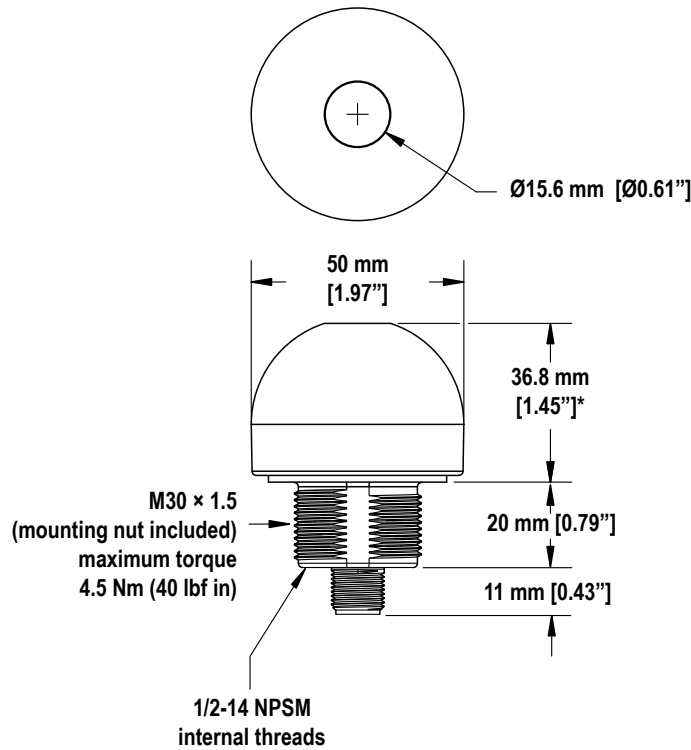

*For push-button models, this dimension is 44.2 mm (1.74 in)

Accessories

Brackets

SMB30A

- Right-angle bracket with curved slot for versatile orientation
- Clearance for M6 (¼ in) hardware
- Mounting hole for 30 mm sensor
- 12-ga. stainless steel

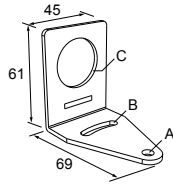

Hole center spacing: A to B=40
 Hole size: A=ø 6.3, B= 27.1 x 6.3, C=ø 30.5

SMB30FA

- Swivel bracket with tilt and pan movement for precise adjustment
- Mounting hole for 30 mm sensor
- 12-ga. 304 stainless steel
- Easy sensor mounting to extrude rail T-slot
- Metric and inch size bolt available

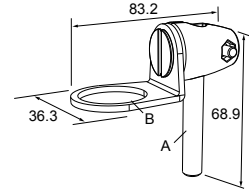

Bolt thread: SMB30FA, A= 3/8 - 16 x 2 in; SMB30FAM10, A= M10 - 1.5 x 50
 Hole size: B= ø 30.1

SMB30FVK

- V-clamp, flat bracket and fasteners for mounting to pipe or extensions
- Clamp accommodates 28 mm dia. tubing or 1 in. square extrusions
- 30 mm hole for mounting sensors

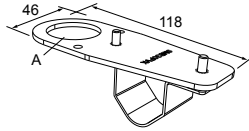

Hole size: A= ø 31

SMB30RAVK

- V-clamp, right-angle bracket and fasteners for mounting sensors to pipe or extrusion
- Clamp accommodates 28 mm dia. tubing or 1 in. square extrusions
- 30 mm hole for mounting sensors

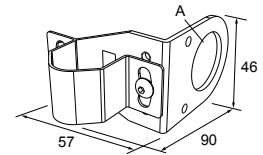

Hole size: A= ø 30.5

Cordsets

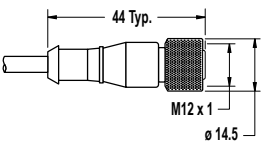
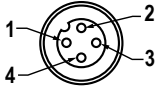
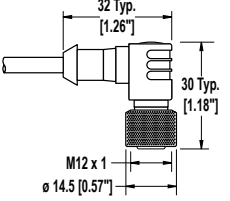
4-Pin Threaded M12/Euro-Style Cordsets				
Model	Length	Style	Dimensions	Pinout (Female)
MQDC-406	1.83 m (6 ft)	Straight		
MQDC-415	4.57 m (15 ft)			
MQDC-430	9.14 m (30 ft)			
MQDC-450	15.2 m (50 ft)			
MQDC-406RA	1.83 m (6 ft)	Right-Angle		<p>1 = Brown 2 = White 3 = Blue 4 = Black</p>
MQDC-415RA	4.57 m (15 ft)			
MQDC-430RA	9.14 m (30 ft)			
MQDC-450RA	15.2 m (50 ft)			

Banner Engineering Corp. Limited Warranty

Banner Engineering Corp. warrants its products to be free from defects in material and workmanship for one year following the date of shipment. Banner Engineering Corp. will repair or replace, free of charge, any product of its manufacture which, at the time it is returned to the factory, is found to have been defective during the warranty period. This warranty does not cover damage or liability for misuse, abuse, or the improper application or installation of the Banner product.

THIS LIMITED WARRANTY IS EXCLUSIVE AND IN LIEU OF ALL OTHER WARRANTIES WHETHER EXPRESS OR IMPLIED (INCLUDING, WITHOUT LIMITATION, ANY WARRANTY OF MERCHANTABILITY OR FITNESS FOR A PARTICULAR PURPOSE), AND WHETHER ARISING UNDER COURSE OF PERFORMANCE, COURSE OF DEALING OR TRADE USAGE.

This Warranty is exclusive and limited to repair or, at the discretion of Banner Engineering Corp., replacement. IN NO EVENT SHALL BANNER ENGINEERING CORP. BE LIABLE TO BUYER OR ANY OTHER PERSON OR ENTITY FOR ANY EXTRA COSTS, EXPENSES, LOSSES, LOSS OF PROFITS, OR ANY INCIDENTAL, CONSEQUENTIAL OR SPECIAL DAMAGES RESULTING FROM ANY PRODUCT DEFECT OR FROM THE USE OR INABILITY TO USE THE PRODUCT, WHETHER ARISING IN CONTRACT OR WARRANTY, STATUTE, TORT, STRICT LIABILITY, NEGLIGENCE, OR OTHERWISE.

Banner Engineering Corp. reserves the right to change, modify or improve the design of the product without assuming any obligations or liabilities relating to any product previously manufactured by Banner Engineering Corp. Any misuse, abuse, or improper application or installation of this product or use of the product for personal protection applications when the product is identified as not intended for such purposes will void the product warranty. Any modifications to this product without prior express approval by Banner Engineering Corp will void the product warranties. All specifications published in this document are subject to change; Banner reserves the right to modify product specifications or update documentation at any time. Specifications and product information in English supersede that which is provided in any other language. For the most recent version of any documentation, refer to: www.bannerengineering.com.