

●Lineup

Maximum output current (Max.)	Shutdown Switch	Package		Output voltage (Typ.)	Orderable Part Number
500mA	With Switch	TO252-5	Reel of 2000	1.0V	BD10KA5WFP-E2
				1.2V	BD12KA5WFP-E2
				1.5V	BD15KA5WFP-E2
				1.8V	BD18KA5WFP-E2
				2.5V	BD25KA5WFP-E2
				3.0V	BD30KA5WFP-E2
				3.3V	BD33KA5WFP-E2
				Variable	BD00KA5WFP-E2
		SOP8	Reel of 2500	1.0V	BD10KA5WF-E2
				1.2V	BD12KA5WF-E2
				1.5V	BD15KA5WF-E2
				1.8V	BD18KA5WF-E2
				2.5V	BD25KA5WF-E2
				3.0V	BD30KA5WF-E2
	3.3V			BD33KA5WF-E2	
	Variable	BD00KA5WF-E2			
	No Switch	TO252-3	Reel of 2000	1.0V	BD10KA5FP-E2
				1.2V	BD12KA5FP-E2
				1.5V	BD15KA5FP-E2
				1.8V	BD18KA5FP-E2
				2.5V	BD25KA5FP-E2
3.0V				BD30KA5FP-E2	
3.3V				BD33KA5FP-E2	

●Block Diagrams / Standard Example Application Circuits / Pin Configurations / Pin Descriptions

[BD00KA5WFP]

* Output voltage configuration
 $V_{OUT} = V_{ADJ} \times (R1+R2) \div R1 (V)$
 : $V_{ADJ} = 0.75V (Typ.)$
 : A value of approximately 30kΩ is recommended for R1.

TO252-5(BD00KA5WFP)

Fig.1

Pin No.	PinName	Function
1	CTL	Output voltage ON/OFF control
2	Vcc	Power supply voltage input
3	N.C.	Unconnected terminal
4	OUT	Voltage output
5	ADJ	Output voltage configuration terminal
FIN	GND	GND

[BD00KA5WF]

* Output voltage configuration
 $V_{OUT} = V_{ADJ} \times (R1+R2) \div R1 (V)$
 : $V_{ADJ} = 0.75V (Typ.)$
 : A value of approximately 30kΩ is recommended for R1.

SOP8(BD00KA5WF)

Fig.4

Pin No.	Pin Name	Function
1	OUT	Voltage output
2	ADJ	Output voltage configuration terminal
3	N.C.	Unconnected terminal
4	N.C.	Unconnected terminal
5	CTL	Output voltage ON/OFF control
6	GND	GND
7	GND	GND
8	Vcc	Power supply voltage input

[BDxxKA5WFP]

TO252-5(BDxxKA5WFP)

Fig.2

Pin No.	Pin Name	Function
1	CTL	Output voltage ON/OFF control
2	Vcc	Power supply voltage input
3	N.C.	Unconnected terminal
4	OUT	Voltage output
5	N.C.	Unconnected terminal
FIN	GND	GND

[BDxxKA5WF]

SOP8(BDxxKA5WF)

Fig.5

Pin No.	Pin Name	Function
1	OUT	Voltage output
2	N.C.	Unconnected terminal
3	N.C.	Unconnected terminal
4	N.C.	Unconnected terminal
5	CTL	Output voltage ON/OFF control
6	GND	GND
7	GND	GND
8	Vcc	Power supply voltage input

[BDxxKA5FP]

TO252-3(BDxxKA5FP)

Fig.3

Pin No.	Pin Name	Function
1	Vcc	Power supply voltage input
2	N.C.	Unconnected terminal
3	OUT	Voltage output
FIN	GND	GND

N.C. pins are electrically open to the inside of the IC chip.

● Absolute Maximum Ratings (Ta=25°C)

Parameter	Symbol	Limits	Unit.
Power Supply Voltage	Vcc	-0.3 to +7.0 ^{*1}	V
Output Control Terminal Voltage	VCTL	-0.3 to Vcc ^{*1}	V
Power Dissipation	TO252-3	1200 ^{*2}	mW
	TO252-5	1300 ^{*3}	
	SOP8	687.6 ^{*4}	
Operating Temperature Range	Topr	-40 to +105	°C
Ambient Storage Temperature	Tstg	-55 to +150	°C
Maximum Junction Temperature	Tjmax	150	°C

*1 Must not exceed Pd

*2 When a 70mm×70mm×1.6mm glass epoxy board is used. Reduce by 9.6 mW/°C over 25°C.

*3 When a 70mm×70mm×1.6mm glass epoxy board is used. Reduce by 10.4mW/°C over 25°C.

*4 When a 70mm×70mm×1.6mm glass epoxy board is used. Reduce by 5.5 mW/°C over 25°C.

● Recommended Operating Ratings (Ta=25°C)

Parameter	Symbol	Min.	Max.	Unit.
Input Power Supply Voltage	Vcc	2.3	5.5	V
Output Current	Io	0	500	mA
Output Voltage Configuration Range ^{*5}	Vo	1.0	4.0	V
Output Control Terminal Voltage	VCTL	0	Vcc	V

*5 Only BD00KA5WFP and BD00KA5WF

● Electrical Characteristics

BDxxKA5 Series BDxxKA5W Series

(Unless otherwise specified, Ta=25°C, VCTL=2V, Vcc=2.5V(Vo=1.0V,1.2V,1.5V,1.8V), Vcc=3.3V(Vo=2.5V), Vcc=5.0V(Vo=3.0V,3.3V))

Parameter	Symbol	Limit			Unit	Conditions
		Min	Typ	Max		
Output Voltage	Vo	Vo(T)-0.015	Vo(T)	Vo(T)+0.015	V	Io=200mA (Vo=1.0V,1.2V)
		Vo(T) × 0.99	Vo(T)	Vo(T) × 1.01		Io=200mA (Vo ≥ 1.5V)
Shut Down Current	I _{sd}	—	0	1	μA	VCTL=0V, Io=0mA (OFFmode)
Bias Current	I _b	—	350	550	μA	Io=0mA
Dropout Voltage ^{*6}	ΔV _d	—	0.12	0.20	V	Io=200mA, Vcc=0.95 × Vo
Peak Output Current	Io	500	—	—	mA	
Ripple Rejection	R.R.	—	50	—	dB	f=120Hz, ein ^{*9} =-10dBV, Io=100mA
Line Regulation ^{*7}	Reg.I	—	10	35	mV	Vcc=Vo+0.5V→5.5V, Io=200mA
Load Regulation	Reg.L	—	25	75	mV	Io=0mA→500mA
Temperature Coefficient of Output Voltage ^{*8}	Tcvo	—	±100	—	ppm/°C	Io=5mA, Tj=0 to 125°C
CTL ON Mode Voltage	VCTLON	2.0	—	—	V	ACTIVE MODE, Io=0mA
CTL OFF Mode Voltage	VCTL _{OFF}	—	—	0.8	V	OFF MODE, Io=0mA
CTL Input Current	I _{CTL}	20	40	60	μA	Io=0mA

Vo(T) : Output Voltage

*6 Vo ≥ 2.5V

*7 1.0 ≤ Vo ≤ 1.8V, Vcc=2.3V→5.5V

*8 Not 100% tested

*9 ein : Input Voltage Ripple

●Electrical Characteristics – continued

BD00KA5W Series

(Unless otherwise specified, $T_a=25^{\circ}\text{C}$, $V_{CC}=2.5\text{V}$, $V_{CTL}=2\text{V}$, $V_o=1.5\text{V}$)

Parameter	Symbol	Limit			Unit	Conditions
		Min	Typ	Max		
Shut Down Current	I _{sd}	—	0	1	μA	V _{CTL} =0V, I _o =0mA (OFFmode)
Bias Current	I _b	—	350	550	μA	I _o =0mA
Reference Voltage	V _{ADJ}	0.742	0.750	0.758	V	I _o =50mA
Dropout Voltage ^{*10}	ΔV _d	—	0.12	0.20	V	I _o =200mA, V _{CC} =0.95 × V _o
Peak Output Current	I _o	500	—	—	mA	
Ripple Rejection	R.R.	—	50	—	dB	f=120Hz, e _{in} ^{*12} =-10dBV, I _o =100mA
Line Regulation	Reg.I	—	10	35	mV	V _{CC} =V _o +0.5V→5.5V, I _o =200mA
Load Regulation	Reg.L	—	25	75	mV	I _o =0mA→500mA
Temperature Coefficient of Output Voltage ^{*11}	T _{cv}	—	±100	—	ppm/°C	I _o =5mA, T _j =0 to 125°C
CTL ON Mode Voltage	V _{CTLON}	2.0	—	—	V	ACTIVE MODE, I _o =0mA
CTL OFF Mode Voltage	V _{CTLOFF}	—	—	0.8	V	OFF MODE, I _o =0mA
CTL Input Current	I _{CTL}	20	40	60	μA	I _o =0mA

^{*10} V_o ≥ 2.5V^{*11} Not 100% tested^{*12} e_{in} : Input Voltage Ripple

● Typical Performance Curves

(Unless specified otherwise, $V_{CC}=25V, V_{CTL}=2V,$ and $I_o=0mA$)

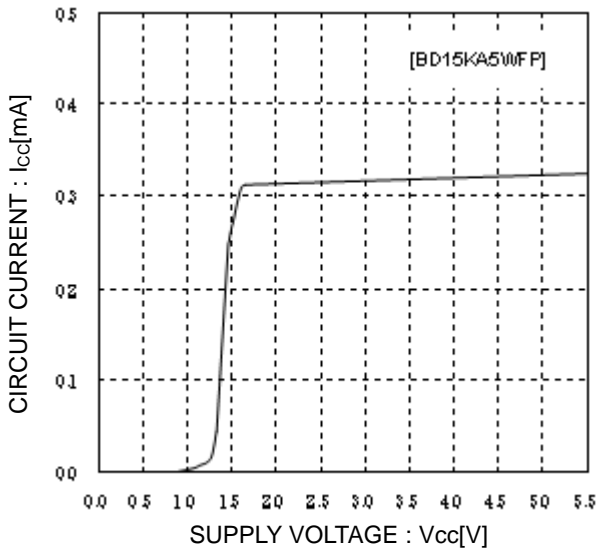

Fig.6
Circuit current

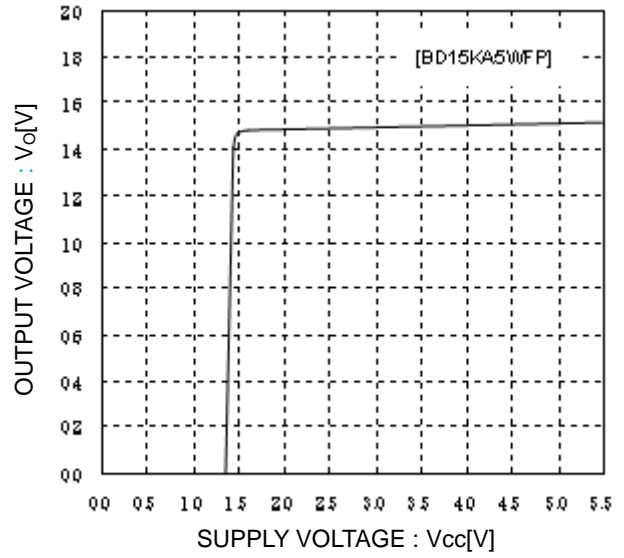

Fig.7
Input Stability (I_o=0mA)

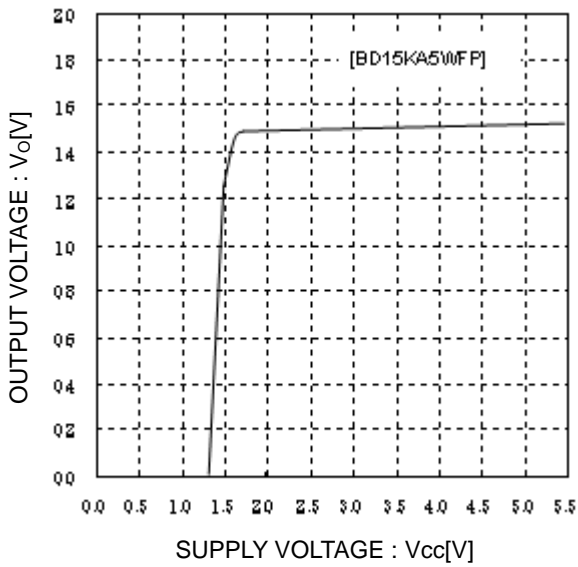

Fig.8
Input Stability
(I_o=500mA)

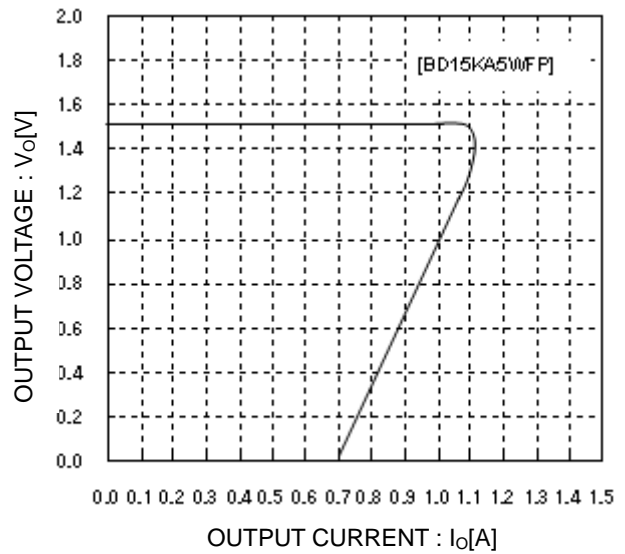

Fig.9
Load Stability

● Typical Performance Curves - continued

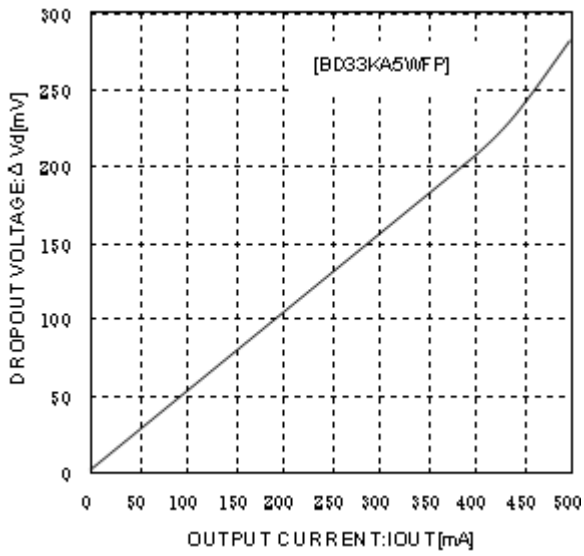

Fig.10
Input/Output Voltage Difference
(V_{CC}=3.135V)

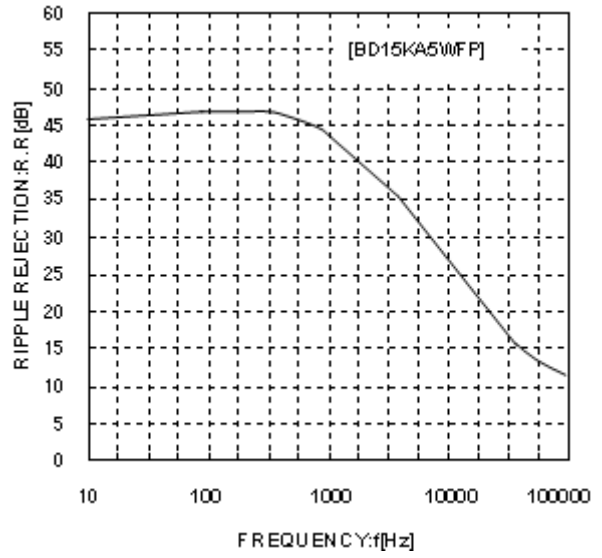

Fig.11
Ripple Rejection
(e_{in}=10dBV, I_o=100mA)

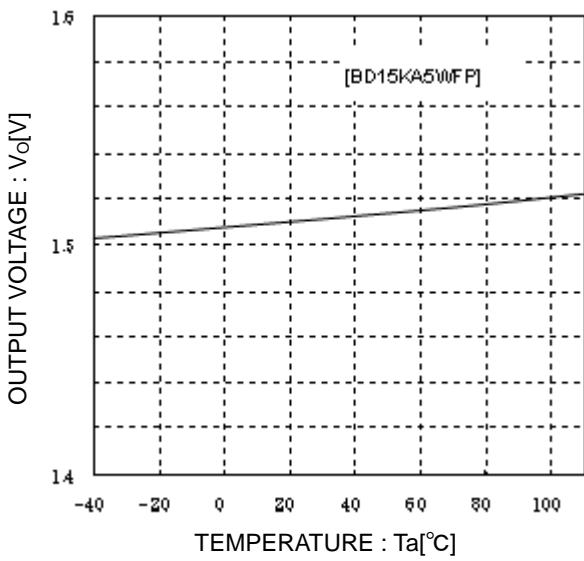

Fig.12
Output Voltage
(I_o=5mA)

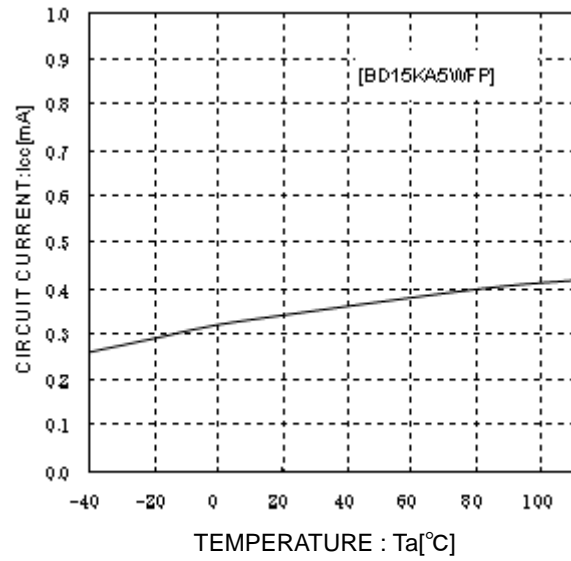

Fig.13
Circuit Current
Temperature Characteristics

● Typical Performance Curves - continued

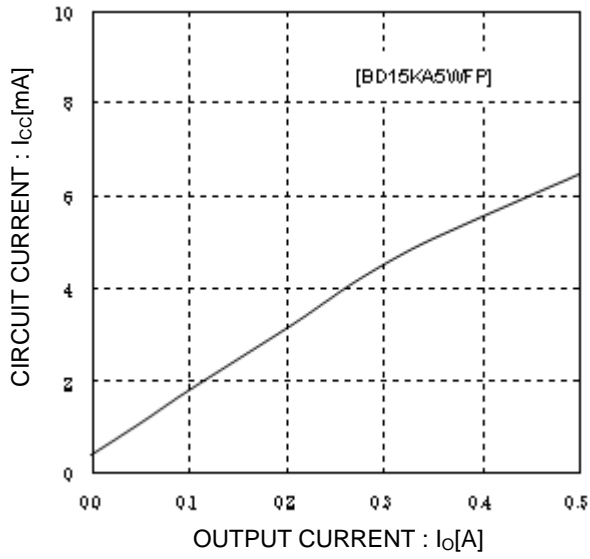

Fig.14
Circuit Current by load Level

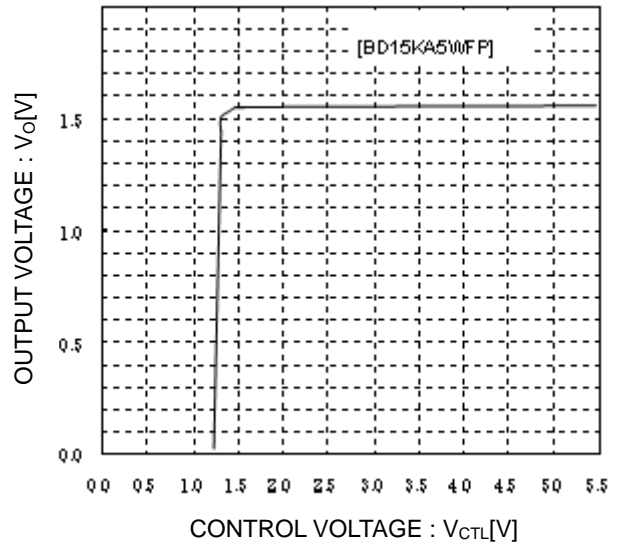

Fig.15
CTL Voltage vs. Output Voltage

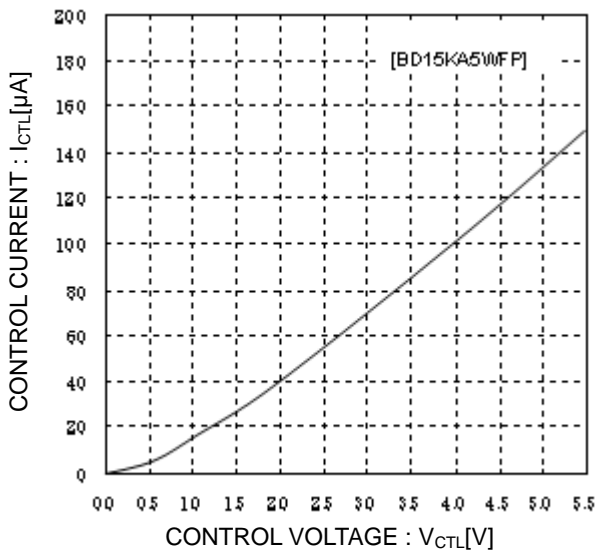

Fig.16
CTL Voltage vs. Output Current

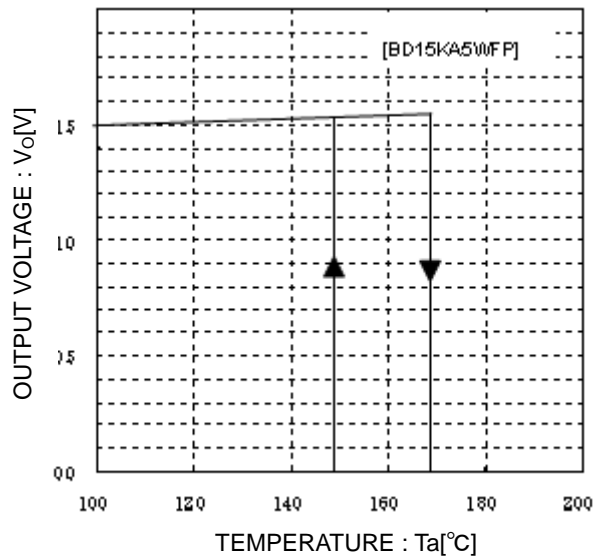

Fig.17
Thermal Shutdown
Circuit Characteristics ($I_o=5mA$)

● I/O equivalence circuit

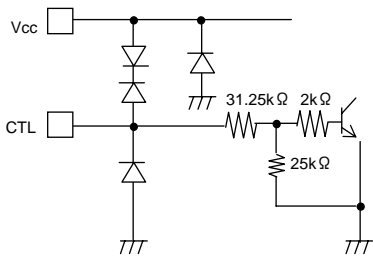

Fig.18

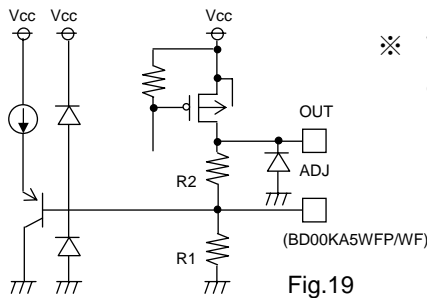

Fig.19

※ With BD00KA5WFP/WF, R1 and R2 are connected outside the IC between ADJ and GND and between OUT and ADJ.

● Power Dissipation

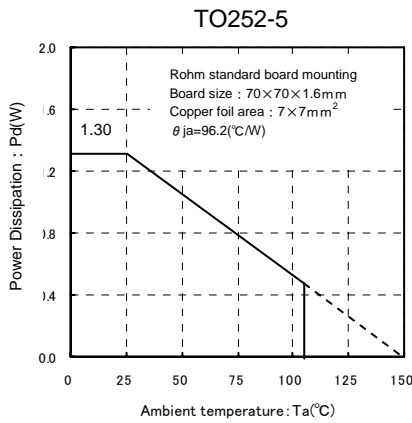

Fig.20 Power Dissipation heat reducing characteristics

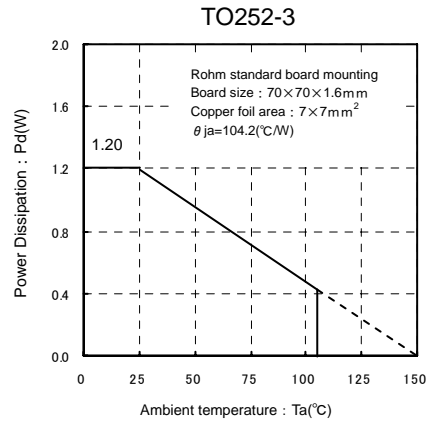

Fig.21 Power Dissipation heat reducing characteristics

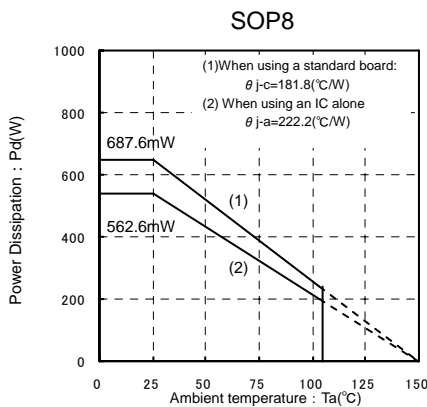

Fig.22 Power Dissipation heat reducing characteristics

When using at temperatures over $T_a=25^\circ\text{C}$, please refer to the power dissipation shown in Fig.20 through 22.

The IC characteristics are closely related to the temperature at which the IC is used, so if the temperature exceeds the maximum junction temperature $T_{j\text{MAX}}$, the device may malfunction or be destroyed. The heat of the IC requires sufficient consideration regarding instantaneous destruction and long-term operation reliability. In order to protect the IC from thermal damage, it is necessary to operate it at temperatures less than the maximum junction temperature $T_{j\text{MAX}}$.

Even when the ambient temperature T_a is a normal temperature (25°C), the chip(junction) temperature T_j may be quite high, so please operate the IC at temperatures less than the acceptable loss Pd.

The calculation method for power consumption Pc(W) is as follows :

$$Pc = (V_{cc}-V_o) \times I_o + V_{cc} \times I_{cca}$$

Acceptable loss $P_d \geq Pc$

V_{cc} : Input voltage
 V_o : Output voltage
 I_o : Load current
 I_{cca} : Circuit current

Solving for the load current I_o in order to operate within the acceptable loss,

$$I_o \leq \frac{P_c - V_{cc} \times I_{cca}}{V_{cc} - V_o}$$

It is then possible to find the maximum load current I_{oMAX} with respect to the applied voltage V_{cc} at the time of thermal design.

Calculation Example

Example 1) When Ta=85°C, V_{cc}=2.5V, V_o=1.0V

$$I_o \leq \frac{0.676 - 2.5 \times I_{cca}}{2.5 - 1.0}$$

$I_o \leq 440\text{mA}$ (I_{cca} : 6mA)

BA10KA5WFP (TO252-5 packaging)

$\theta_{ja} = 96.2^\circ\text{C/W} \rightarrow -10.4\text{mW}/^\circ\text{C}$
 $25^\circ\text{C} = 1300\text{mW} \rightarrow 85^\circ\text{C} = 676\text{mW}$

Please refer to the above information and keep thermal designs within the scope of acceptable loss for all operating temperature ranges.

The power consumption Pc of the IC when there is a short circuit (short between V_o and GND) is :

$$P_c = V_{cc} \times (I_{cca} + I_{short})$$

*I_{short} : Short circuit current

●Terminal Vicinity Settings and Cautions

- V_{cc} Terminal
 Please attach a capacitor (greater than 1μF) between V_{cc} and GND.
 The capacitance values differ depending on the application, so chose a capacitor with sufficient margin and verify the operation on actual board.
- GND Terminal
 Please be sure to keep the set ground and IC ground at the same potential level so that a potential difference does not arise between them. If a potential difference arises between the set ground and the IC ground, the preset voltage will not be output properly, causing the system to become unstable. Please reduce the impedance by making the ground patterns as wide as possible and reducing the distance between the set ground and the IC ground as much as possible.
- CTL Terminal

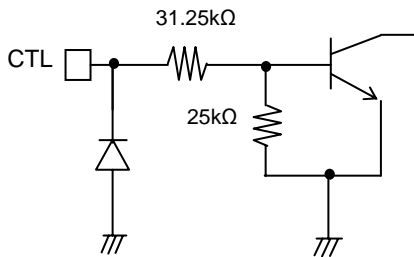

Fig.23 Input equivalent circuit

The CTL terminal is turned ON at 2.0V and higher, and OFF at 0.8V and lower, within the operating power supply voltage range. The power supply and the CTL terminal may be started up and shut down in any order without problems.

●Vo Terminal

Please be sure to attach an anti-oscillation capacitor between Vo and GND.

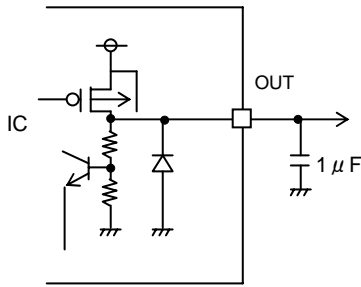

Fig.24 Output Equivalent Circuit

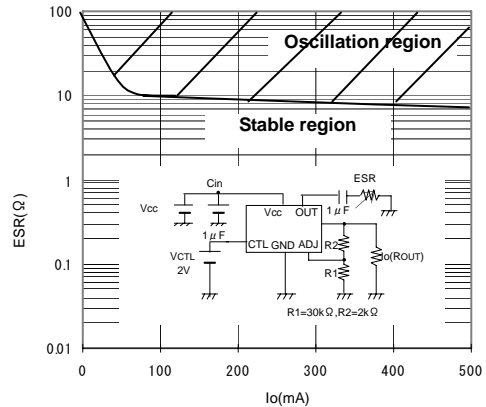
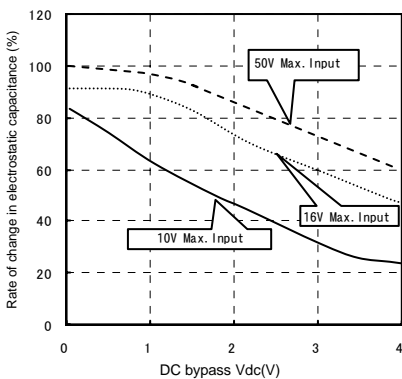
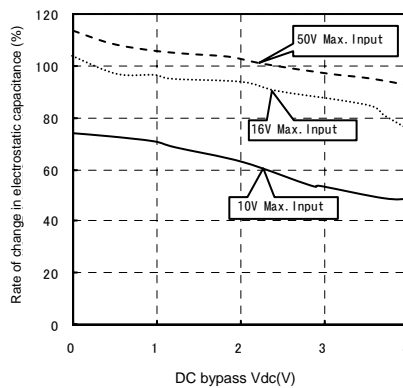

Fig.25 ESR-Io Characteristics

Be sure to place an anti-oscillation capacitor between the output terminal and the GND. Oscillations may arise if the capacitance value changes, due to factors such as temperature changes. A 1μF capacitor with small internal series resistance (ESR) such as a ceramic capacitor is recommended as an anti-oscillation capacitor. Ceramic capacitors generally have favorable temperature characteristics and DC bypass characteristics. When selecting a ceramic capacitor, a high voltage capacitor (good DC bypass characteristics) with temperature characteristics that are superior to those of X5R or X7R, is recommended. In applications where input voltage and load fluctuations are rapid, please decide on a capacitor after sufficiently confirming its properties according to its specifications in the actual application.



(a) Capacitance-bypass characteristics (Y5V)



(b) Capacitance-bypass characteristics (X5R, X7R)

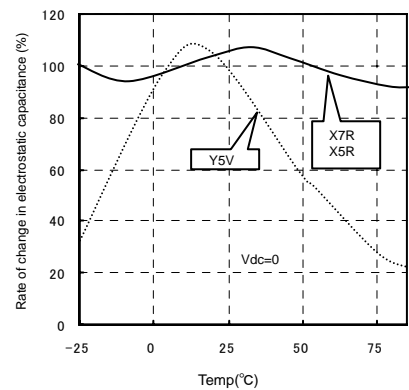

(c) Capacitance-temperature characteristics (X5R, X7R, Y5V)

Fig.26 General characteristics of ceramic capacitors

●Operational Notes

○Protection Circuits

Over-current Protection Circuit

A built-in over-current protection circuit corresponding to the current capacity prevents the destruction of the IC when there are load shorts. This protection circuit is a “7”-shaped current control circuit that is designed such that the current is restricted and does not latch even when a large current momentarily flows through the system with a high-capacitance capacitor. However, while this protection circuit is effective for the prevention of destruction due to unexpected accidents, it is not suitable for continuous operation or transient use. Please be aware when creating thermal designs that the over-current protection circuit has negative current capacity characteristics with regard to temperature.

○Thermal Shutdown Circuit (Thermal Protection)

This system has a built-in temperature protection circuit for the purpose of protecting the IC from thermal damage. As shown in Fig. 20-22, this must be used within the range of acceptable loss, but if the acceptable loss is continuously exceeded, the chip temperature T_j increases, causing the thermal shutdown circuit to operate. When the thermal shutdown circuit operates, the operation of the circuit is suspended. The circuit resumes operation immediately after the chip temperature T_j decreases, so the output repeats the ON and OFF states (Please refer to Fig.17 for the temperatures at which the temperature protection circuit operates).

There are cases in which the IC is destroyed due to thermal runaway when it is left in the overloaded state. Be sure to avoid leaving the IC in the overloaded state.

○Reverse Current

In order to prevent the destruction of the IC when a reverse current flows through the IC, it is recommended that a diode be placed between the Vcc and Vo and a pathway be created so that the current can escape (Refer to Fig.27).

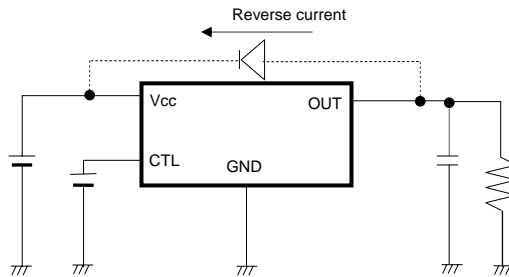

Fig.27 Bypass diode

○This IC is BI-CMOS IC that has a P-board (substrate) and P+ isolation between each element, as shown in Fig.28. A P-N junction is formed between this P-layer and the N-layer of each element, and the P-N junction operates as :

- a parasitic diode when the electric potential relationship is GND > Pin A, GND > Pin B, or
- a parasitic transistor when the electric potential relationship is Pin B > GND > Pin A.

Parasitic elements are structurally inevitable in the IC. The operation of parasitic elements induces mutual interference between circuits, causing malfunctions and eventually the destruction of the IC. Take precaution as not to use the IC in ways that would cause parasitic elements to operate. For example, applying a voltage that is lower than the GND (P-board) to the input terminal.

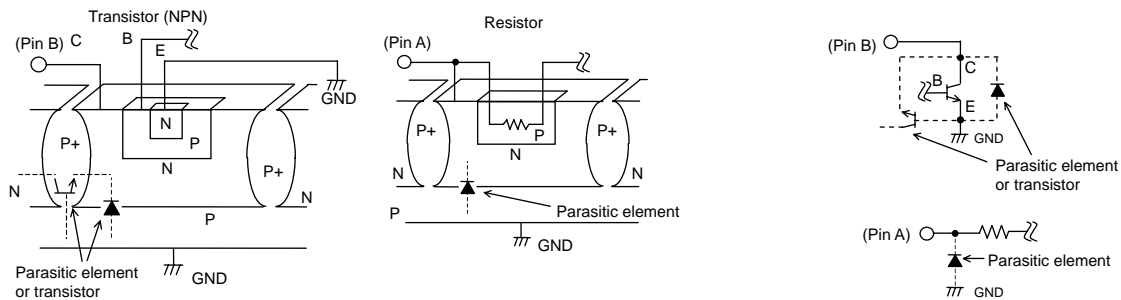

Fig.28 Basic structure example

Status of this document

The Japanese version of this document is formal specification. A customer may use this translation version only for a reference to help reading the formal version.

If there are any differences in translation version of this document formal version takes priority.

●Physical Dimension Tape and Reel Information

SOP8

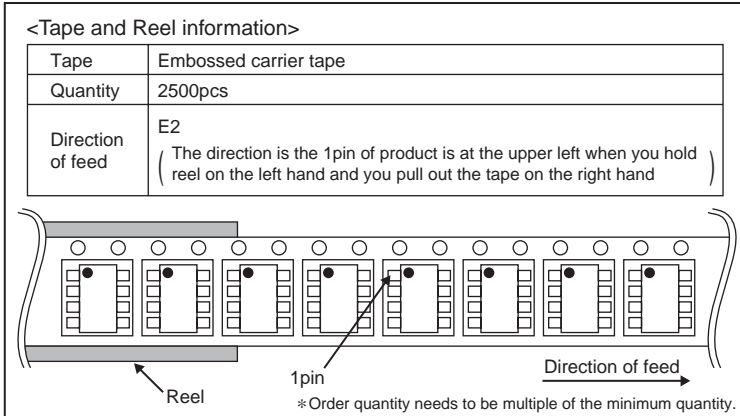
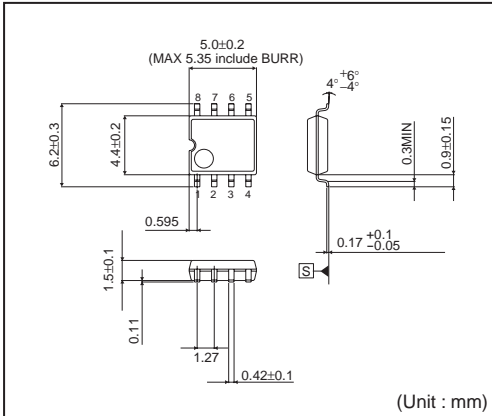

TO252-3

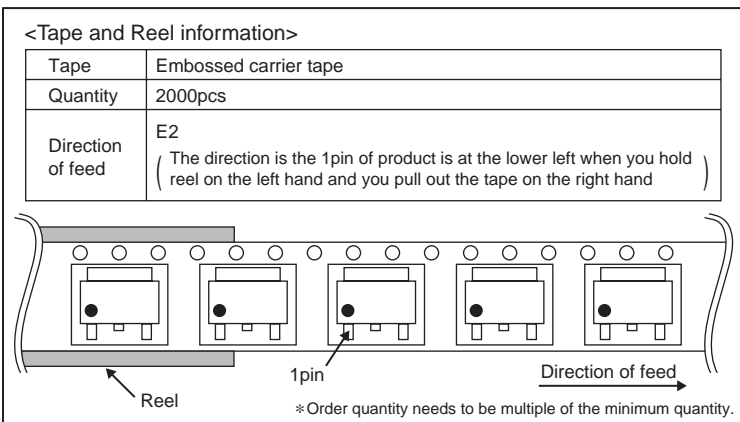
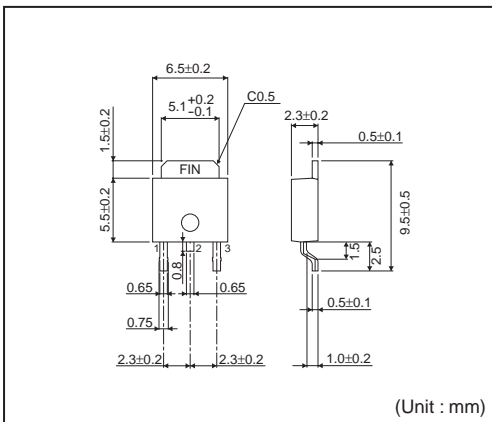

TO252-5

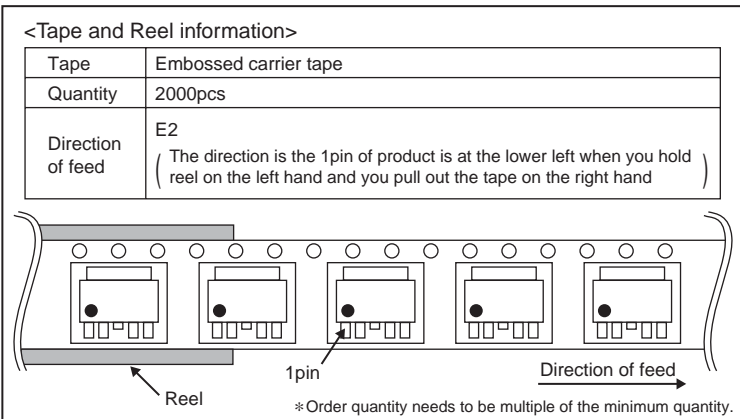
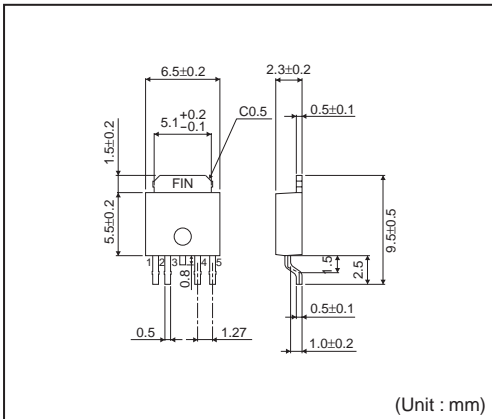

●Marking Diagrams

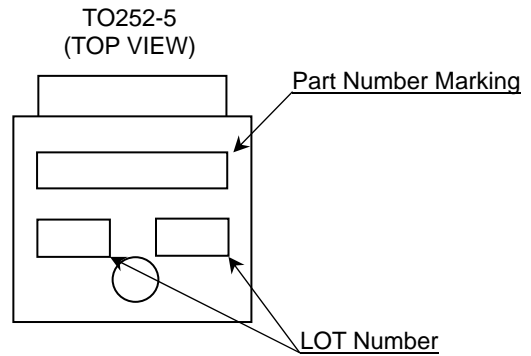
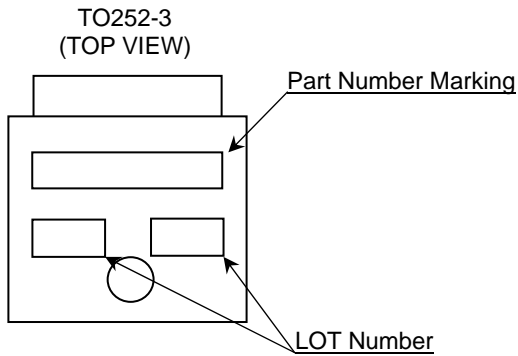
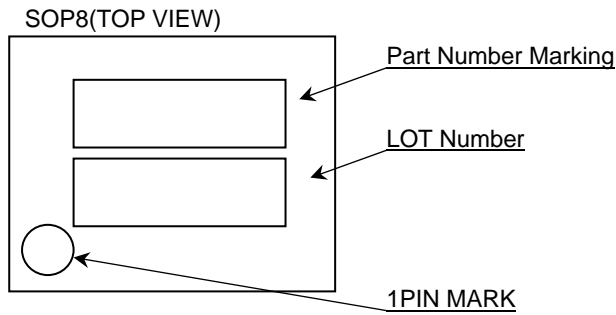

Orderable Part Number	Package	Part Number Marking
BD10KA5WFP-E2	TO252-5	10KA5W
BD12KA5WFP-E2		12KA5W
BD15KA5WFP-E2		15KA5W
BD18KA5WFP-E2		18KA5W
BD25KA5WFP-E2		25KA5W
BD30KA5WFP-E2		30KA5W
BD33KA5WFP-E2		33KA5W
BD00KA5WFP-E2		00KA5W
BD10KA5WF-E2	SOP8	10KA5W
BD12KA5WF-E2		12KA5W
BD15KA5WF-E2		15KA5W
BD18KA5WF-E2		18KA5W
BD25KA5WF-E2		25KA5W
BD30KA5WF-E2		30KA5W
BD33KA5WF-E2		33KA5W
BD00KA5WF-E2		00KA5W
BD10KA5FP-E2	TO252-3	10KA5
BD12KA5FP-E2		12KA5
BD15KA5FP-E2		15KA5
BD18KA5FP-E2		18KA5
BD25KA5FP-E2		25KA5
BD30KA5FP-E2		30KA5
BD33KA5FP-E2		33KA5

●Revision History

Date	Revision	Changes
26.Jun.2012	001	New Release

Notice

Precaution on using ROHM Products

- Our Products are designed and manufactured for application in ordinary electronic equipments (such as AV equipment, OA equipment, telecommunication equipment, home electronic appliances, amusement equipment, etc.). If you intend to use our Products in devices requiring extremely high reliability (such as medical equipment ^(Note 1), transport equipment, traffic equipment, aircraft/spacecraft, nuclear power controllers, fuel controllers, car equipment including car accessories, safety devices, etc.) and whose malfunction or failure may cause loss of human life, bodily injury or serious damage to property ("Specific Applications"), please consult with the ROHM sales representative in advance. Unless otherwise agreed in writing by ROHM in advance, ROHM shall not be in any way responsible or liable for any damages, expenses or losses incurred by you or third parties arising from the use of any ROHM's Products for Specific Applications.

(Note1) Medical Equipment Classification of the Specific Applications

JAPAN	USA	EU	CHINA
CLASS III	CLASS III	CLASS II b	CLASS III
CLASS IV		CLASS III	

- ROHM designs and manufactures its Products subject to strict quality control system. However, semiconductor products can fail or malfunction at a certain rate. Please be sure to implement, at your own responsibilities, adequate safety measures including but not limited to fail-safe design against the physical injury, damage to any property, which a failure or malfunction of our Products may cause. The following are examples of safety measures:
 - Installation of protection circuits or other protective devices to improve system safety
 - Installation of redundant circuits to reduce the impact of single or multiple circuit failure
- Our Products are designed and manufactured for use under standard conditions and not under any special or extraordinary environments or conditions, as exemplified below. Accordingly, ROHM shall not be in any way responsible or liable for any damages, expenses or losses arising from the use of any ROHM's Products under any special or extraordinary environments or conditions. If you intend to use our Products under any special or extraordinary environments or conditions (as exemplified below), your independent verification and confirmation of product performance, reliability, etc. prior to use, must be necessary:
 - Use of our Products in any types of liquid, including water, oils, chemicals, and organic solvents
 - Use of our Products outdoors or in places where the Products are exposed to direct sunlight or dust
 - Use of our Products in places where the Products are exposed to sea wind or corrosive gases, including Cl₂, H₂S, NH₃, SO₂, and NO₂
 - Use of our Products in places where the Products are exposed to static electricity or electromagnetic waves
 - Use of our Products in proximity to heat-producing components, plastic cords, or other flammable items
 - Sealing or coating our Products with resin or other coating materials
 - Use of our Products without cleaning residue of flux (even if you use no-clean type fluxes, cleaning residue of flux is recommended); or Washing our Products by using water or water-soluble cleaning agents for cleaning residue after soldering
 - Use of the Products in places subject to dew condensation
- The Products are not subject to radiation-proof design.
- Please verify and confirm characteristics of the final or mounted products in using the Products.
- In particular, if a transient load (a large amount of load applied in a short period of time, such as pulse. is applied, confirmation of performance characteristics after on-board mounting is strongly recommended. Avoid applying power exceeding normal rated power; exceeding the power rating under steady-state loading condition may negatively affect product performance and reliability.
- De-rate Power Dissipation (Pd) depending on Ambient temperature (Ta). When used in sealed area, confirm the actual ambient temperature.
- Confirm that operation temperature is within the specified range described in the product specification.
- ROHM shall not be in any way responsible or liable for failure induced under deviant condition from what is defined in this document.

Precaution for Mounting / Circuit board design

- When a highly active halogenous (chlorine, bromine, etc.) flux is used, the residue of flux may negatively affect product performance and reliability.
- In principle, the reflow soldering method must be used; if flow soldering method is preferred, please consult with the ROHM representative in advance.

For details, please refer to ROHM Mounting specification

Precautions Regarding Application Examples and External Circuits

1. If change is made to the constant of an external circuit, please allow a sufficient margin considering variations of the characteristics of the Products and external components, including transient characteristics, as well as static characteristics.
2. You agree that application notes, reference designs, and associated data and information contained in this document are presented only as guidance for Products use. Therefore, in case you use such information, you are solely responsible for it and you must exercise your own independent verification and judgment in the use of such information contained in this document. ROHM shall not be in any way responsible or liable for any damages, expenses or losses incurred by you or third parties arising from the use of such information.

Precaution for Electrostatic

This Product is electrostatic sensitive product, which may be damaged due to electrostatic discharge. Please take proper caution in your manufacturing process and storage so that voltage exceeding the Products maximum rating will not be applied to Products. Please take special care under dry condition (e.g. Grounding of human body / equipment / solder iron, isolation from charged objects, setting of Ionizer, friction prevention and temperature / humidity control).

Precaution for Storage / Transportation

1. Product performance and soldered connections may deteriorate if the Products are stored in the places where:
 - [a] the Products are exposed to sea winds or corrosive gases, including Cl₂, H₂S, NH₃, SO₂, and NO₂
 - [b] the temperature or humidity exceeds those recommended by ROHM
 - [c] the Products are exposed to direct sunshine or condensation
 - [d] the Products are exposed to high Electrostatic
2. Even under ROHM recommended storage condition, solderability of products out of recommended storage time period may be degraded. It is strongly recommended to confirm solderability before using Products of which storage time is exceeding the recommended storage time period.
3. Store / transport cartons in the correct direction, which is indicated on a carton with a symbol. Otherwise bent leads may occur due to excessive stress applied when dropping of a carton.
4. Use Products within the specified time after opening a humidity barrier bag. Baking is required before using Products of which storage time is exceeding the recommended storage time period.

Precaution for Product Label

QR code printed on ROHM Products label is for ROHM's internal use only.

Precaution for Disposition

When disposing Products please dispose them properly using an authorized industry waste company.

Precaution for Foreign Exchange and Foreign Trade act

Since our Products might fall under controlled goods prescribed by the applicable foreign exchange and foreign trade act, please consult with ROHM representative in case of export.

Precaution Regarding Intellectual Property Rights

1. All information and data including but not limited to application example contained in this document is for reference only. ROHM does not warrant that foregoing information or data will not infringe any intellectual property rights or any other rights of any third party regarding such information or data. ROHM shall not be in any way responsible or liable for infringement of any intellectual property rights or other damages arising from use of such information or data.:
2. No license, expressly or implied, is granted hereby under any intellectual property rights or other rights of ROHM or any third parties with respect to the information contained in this document.

Other Precaution

1. This document may not be reprinted or reproduced, in whole or in part, without prior written consent of ROHM.
2. The Products may not be disassembled, converted, modified, reproduced or otherwise changed without prior written consent of ROHM.
3. In no event shall you use in any way whatsoever the Products and the related technical information contained in the Products or this document for any military purposes, including but not limited to, the development of mass-destruction weapons.
4. The proper names of companies or products described in this document are trademarks or registered trademarks of ROHM, its affiliated companies or third parties.

General Precaution

1. Before you use our Products, you are requested to carefully read this document and fully understand its contents. ROHM shall not be in any way responsible or liable for failure, malfunction or accident arising from the use of any ROHM's Products against warning, caution or note contained in this document.
2. All information contained in this document is current as of the issuing date and subject to change without any prior notice. Before purchasing or using ROHM's Products, please confirm the latest information with a ROHM sales representative.
3. The information contained in this document is provided on an "as is" basis and ROHM does not warrant that all information contained in this document is accurate and/or error-free. ROHM shall not be in any way responsible or liable for any damages, expenses or losses incurred by you or third parties resulting from inaccuracy or errors of or concerning such information.