

# UNIFIVE

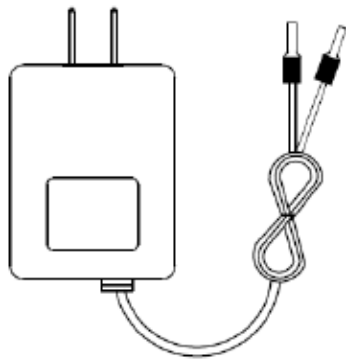

# UNI

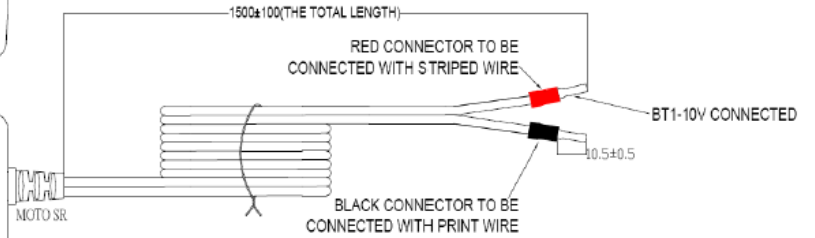
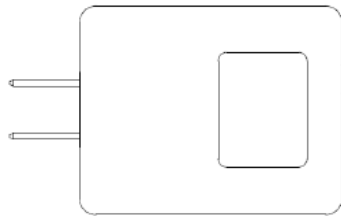
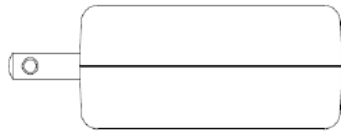
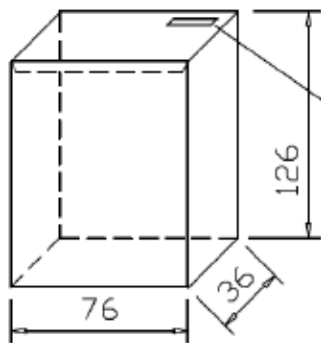

**WHITE BOX LABEL**  
 COLOR: BLACK WORD ON WHITE BASE  
 MATERIAL: COPPER PLATE PAPER

Model: UN315-2485 (US)  
 Atop part: 50500161240002G

銅板紙+光膜

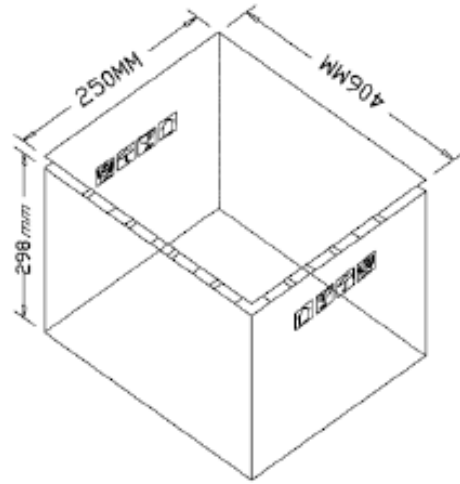
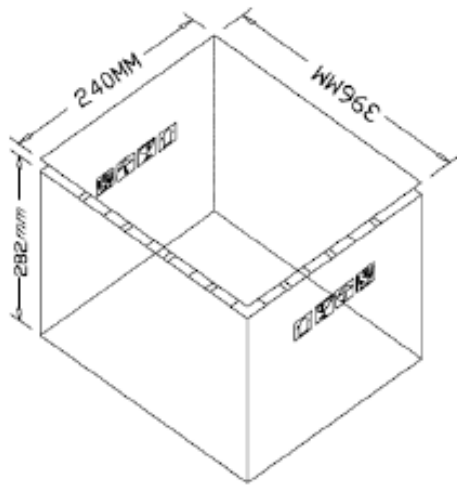

TOLERANCE:  $\pm 5\text{mm}$