

150 mA LDO Regulator for Industrial Applications

NO.EA-340-220531

OUTLINE

The R1180x is a CMOS-based voltage regulator IC with high output voltage accuracy, extremely low supply current, and low ON-resistance. This IC consists of a voltage reference unit, an error amplifier, resistor-net for voltage setting, a current limit circuit which prevents the destruction by excess current, and so on.

The output voltage is fixed with high accuracy. B version has a chip enable pin, therefore ultra-low consumption current standby mode can be realized with the pin.

The R1180x is available in SOT-23-5 and SON1612-6 package which is possible to mount at high density.

This is a high-reliability semiconductor device for industrial applications (-Y) that has passed both the screening at high temperature and the reliability test with extended hours. This line of products operate in a wide temperature range from low temperature to high temperature to support harsh environment applications.

FEATURES

- Input Voltage (Maximum Rating)..... 1.7V to 6.0V (6.5V)
- Operating Temperature Range -50°C to 105°C
- Supply Current..... Typ. 1.0μA
(Except the current through CE pull-down circuit)
- Standby Mode..... Typ. 0.1μA
- Dropout Voltage Typ. 0.25V (I_{OUT}=150mA 3.0V Output type)
- Temperature-Drift Coefficient of Output Voltage Typ. ±100ppm/°C
- Line Regulation Typ. 0.05%/V
- Output Voltage Accuracy..... ±2.0%
- Output Voltage Range..... 1.2V, 1.5V, 1.8V, 1.85V, 2.0V, 2.3V, 2.5V, 2.8V, 3.0V, 3.3V, 3.4V
Contact our sales representatives for other voltages.
- Package SOT-23-5, SON1612-6
- Built-in Fold Back Protection Circuit Typ. 40mA (Current at short mode)
- Recommended Ceramic Capacitor to IC 0.1μF or more

APPLICATIONS

- Industrial equipments such as FAs and smart meters
- Equipments used under high-temperature conditions such as surveillance camera and vending machine
- Equipments accompanied by self-heating such as motor and lighting

BLOCK DIAGRAMS

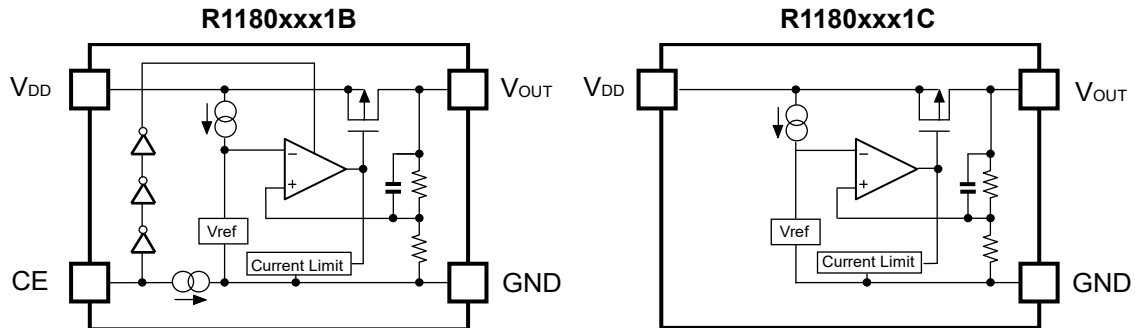

SELECTION GUIDE

The output voltage and CE pin polarity for the ICs can be selected at the user's request.

Product Name	Package	Quantity per Reel	Pb Free	Halogen Free
R1180Nxx1*-TR-YE	SOT-23-5	3,000 pcs	Yes	Yes
R1180Dxx1*-TR-YE	SON1612-6	4,000 pcs	Yes	Yes

xx: The set output voltage (V_{SET}) can be designated by 1.2V (12), 1.5V (15), 1.8V (18), 1.85V (181*5), 2.0V (20), 2.3V (23), 2.5V (25), 2.8V (28), 3.0V (30), 3.3V (33), and 3.4V (34).

* Contact our sales representatives for other voltages.

* : CE pin polarity is options as follows.

- (B) "H" Active
- (C) without CE pin

PIN DESCRIPTIONS

● SOT-23-5

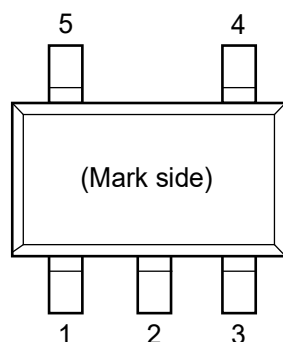

● SON1612-6

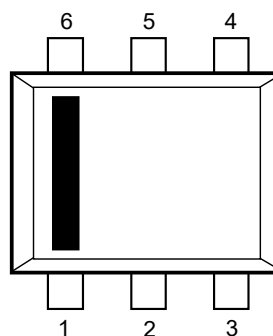

● SOT-23-5

Pin No	Symbol	Pin Description
1	V_{DD}	Input Pin
2	GND	Ground Pin
3	CE or NC	Chip Enable Pin or No Connection
4	NC	No Connection
5	V_{OUT}	Output pin

● SON1612-6

Pin No	Symbol	Pin Description
1	V_{DD}	Input Pin
2	GND	Ground Pin
3	V_{OUT}	Output pin
4	NC	No Connection
5	GND	Ground Pin
6	CE or NC	Chip Enable Pin or No Connection

ABSOLUTE MAXIMUM RATINGS

Symbol	Item	Rating	Unit		
V_{IN}	Input Voltage	6.5	V		
V_{CE}	Input Voltage (CE Pin)	6.5	V		
V_{OUT}	Output Voltage	-0.3 to $V_{IN}+0.3$	V		
I_{OUT}	Output Current	180	mA		
P_D	Power Dissipation*1	SOT-23-5	Standard Land Pattern	525	mW
		SON1612-6	Standard Land Pattern	625	
T_j	Junction Temperature	-50 to 150	°C		
T_{stg}	Storage Temperature Range	-55 to 150	°C		

*1 For Power Dissipation, please refer to *PACKAGE INFORMATION*.

ABSOLUTE MAXIMUM RATINGS

Electronic and mechanical stress momentarily exceeded absolute maximum ratings may cause permanent damage and may degrade the life time and safety for both device and system using the device in the field.
The functional operation at or over these absolute maximum rating is not assured.

RECOMMENDED OPERATING CONDITIONS

Symbol	Item	Rating	Unit
V_{IN}	Input Voltage	1.7 to 6.0	V
T_a	Operating Temperature Range	-50 to 105	°C

RECOMMENDED OPERATING CONDITIONS

All of electronic equipment should be designed that the mounted semiconductor devices operate within the recommended operating conditions. The semiconductor devices cannot operate normally over the recommended operating conditions, even if they are used over such conditions by momentary electronic noise or surge. And the semiconductor devices may receive serious damage when they continue to operate over the recommended operating conditions.

ELECTRICAL CHARACTERISTICS

$V_{IN}=V_{SET}+1.0V$, $C_{IN}=1.0\mu F$, $C_{OUT}=0.1\mu F$, unless otherwise noted.

The specifications surrounded by are guaranteed by design engineering at $-50^{\circ}C \leq T_a \leq 105^{\circ}C$.

• R1180xxx1B/C

($T_a=25^{\circ}C$)

Symbol	Item	Conditions	Min.	Typ.	Max.	Unit	
V_{OUT}	Output Voltage	$1\mu A \leq I_{OUT} \leq 30mA$	$T_a=25^{\circ}C$	$\times 0.980$		$\times 1.020$	V
			$-50^{\circ}C \leq T_a \leq 105^{\circ}C$	 $\times 0.965$		 $\times 1.035$	
I_{OUT}	Output Current	$V_{IN}=V_{SET}+1.0V (V_{SET} \geq 1.4V)$ $V_{IN}=2.4V (V_{SET} < 1.4V)$	 150			mA	
$\Delta V_{OUT}/\Delta I_{OUT}$	Load Regulation	$V_{IN}=V_{SET}+1.0V (V_{SET} \geq 1.4V)$ $V_{IN}=2.4V (V_{SET} < 1.4V)$ $1\mu A \leq I_{OUT} \leq 150mA$		20	 50	mV	
V_{DIF}	Dropout Voltage	$I_{OUT}=150mA$	Refer to the <i>Product-specific Electrical Characteristics</i>				
I_{SS}	Supply Current	$I_{OUT}=0mA$		1.0	 1.85	μA	
$I_{standby}$	Supply Current (Standby)	$V_{CE}=GND$		0.1	 1.0	μA	
$\Delta V_{OUT}/\Delta V_{IN}$	Line Regulation	$I_{OUT}=30mA$ $V_{SET} + 0.5V \leq V_{IN} \leq 6.0V$ ($V_{SET} \geq 1.5V$) $2.0V \leq V_{IN} \leq 6.0V$ ($1.2V \leq V_{SET} \leq 1.4V$)		0.05	 0.20	%/V	
I_{SC}	Short Current Limit	$V_{OUT}=0V$		40		mA	
I_{PD}	CE Pull-down Constant Current	(R1180xxx1B)		0.35		μA	
V_{CEH}	CE Input Voltage "H"	(R1180xxx1B)	 1.2		6	V	
V_{CEL}	CE Input Voltage "L"	(R1180xxx1B)	0		 0.3	V	

All test items listed under Electrical Characteristics are done under the pulse load condition ($T_j \approx T_a = 25^{\circ}C$).

Product-specific Electrical Characteristics

The specifications surrounded by are guaranteed by design engineering at $-50^{\circ}\text{C} \leq T_a \leq 105^{\circ}\text{C}$.

($T_a = 25^{\circ}\text{C}$)

Product Name	V_{OUT} [V]					V_{DIF} [V]	
	$(T_a = 25^{\circ}\text{C})$			$(-50^{\circ}\text{C} \leq T_a \leq 105^{\circ}\text{C})$		TYP.	MAX.
	MIN.	TYP.	MAX.	MIN.	MAX.		
R1180x121x	1.176	1.200	1.224	1.158	1.242	0.85	1.20
R1180x151x	1.470	1.500	1.530	1.448	1.553	0.60	0.90
R1180x181x	1.764	1.800	1.836	1.737	1.863	0.50	0.75
R1180x181x5	1.813	1.850	1.887	1.786	1.914	0.50	0.75
R1180x201x	1.960	2.000	2.040	1.930	2.070	0.40	0.65
R1180x231x	2.254	2.300	2.346	2.220	2.380	0.35	0.55
R1180x251x	2.450	2.500	2.550	2.413	2.588		
R1180x281x	2.744	2.800	2.856	2.702	2.898	0.25	0.40
R1180x301x	2.940	3.000	3.060	2.895	3.105		
R1180x331x	3.234	3.300	3.366	3.185	3.416		
R1180x341x	3.332	3.400	3.468	3.281	3.519		

TYPICAL APPLICATION

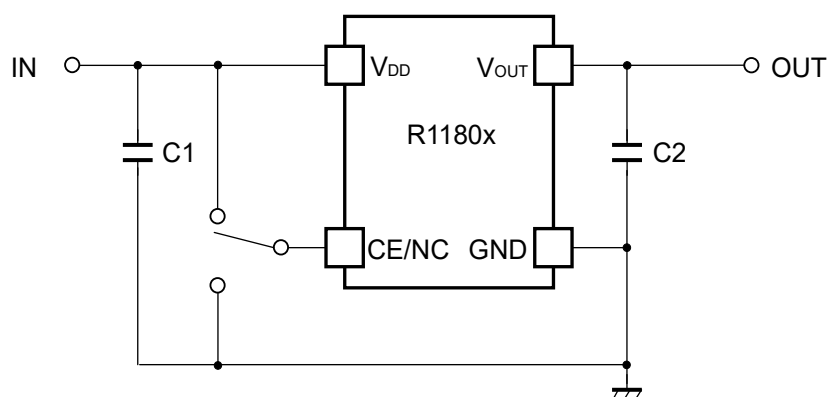

External Parts Example:

C1	1.0 μ F (Ceramic)
C2	0.1 μ F (Ceramic)

TECHNICAL NOTES

When using these ICs, consider the following points:

Phase Compensation

In this device, phase compensation is made for securing stable operation even if the load current is varied. For this purpose, use a capacitor C2 with good frequency characteristics and ESR (Equivalent Series Resistance). (Note: If additional ceramic capacitors are connected with parallel to the output pin with an output capacitor for phase compensation, the operation might be unstable. Because of this, test this device with as same external components as ones to be used on the PCB.)

PCB Layout

Ensure the V_{DD} and GND lines are sufficiently robust. If their impedance is too high, noise pickup or unstable operation may result. Connect a 1.0 μ F input capacitor (C1) between the V_{DD} and GND pins, and as close as possible to the pins. Connect C2 as close as possible to the IC to make the wiring as short as possible. Please refer to the Basic Circuit Diagram as above.

TYPICAL APPLICATION FOR IC CHIP BREAKDOWN PREVENTION

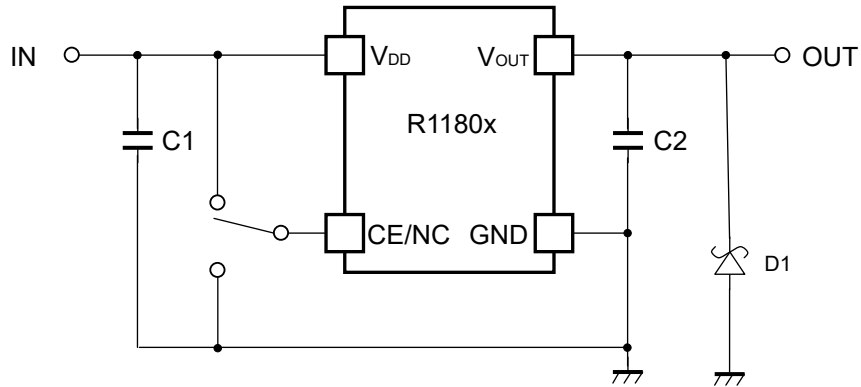

When a sudden surge of electrical current travels along the V_{OUT} pin and GND due to a short-circuit, electrical resonance of a circuit involving an output capacitor (C2) and a short circuit inductor generates a negative voltage and may damage the device or the load devices. Connecting a schottky diode (D1) between the V_{OUT} pin and GND has the effect of preventing damage to them.

PACKAGE INFORMATION

POWER DISSIPATION (SOT-23-5)

The power dissipation of the package is dependent on PCB material, layout, and environmental conditions. The following conditions are used in this measurement.

Measurement Conditions

	Standard Test Land Pattern
Environment	Mounting on Board (Wind Velocity = 0 m/s)
Board Material	Glass Cloth Epoxy Plastic (Double-Sided Board)
Board Dimensions	40 mm × 40 mm × 1.6 mm
Copper Ratio	Top Side: Approx. 50% Bottom Side: Approx. 50%
Through-holes	φ 0.5 mm × 44 pcs

Measurement Result

(Ta = 25°C, Tjmax = 150°C)

	Standard Test Land Pattern	Free Air
Power Dissipation	525 mW	310 mW
Thermal Resistance	$\theta_{ja} = (150 - 25^\circ\text{C}) / 0.525 \text{ W} = 238^\circ\text{C/W}$	400°C/W

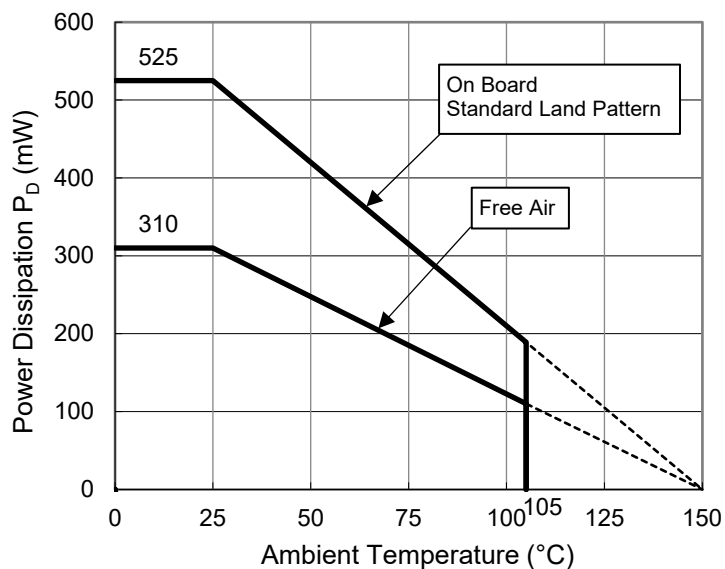

Power Dissipation vs. Ambient Temperature

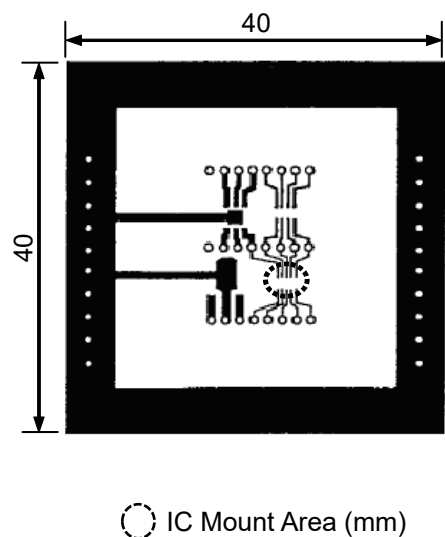

Measurement Board Pattern

PACKAGE DIMENSIONS (SOT-23-5)

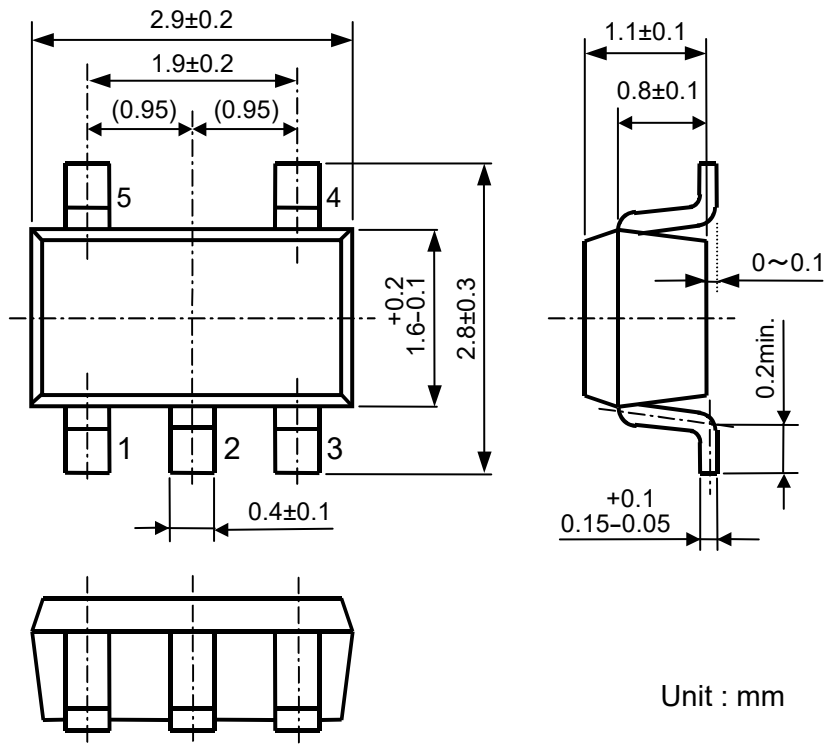

MARK SPECIFICATION (SOT-23-5)

- ①②③: Product Code ... Refer to *R1180N MARK SPECIFICATION TABLE*
- ④⑤: Lot Number ... Alphanumeric Serial Number

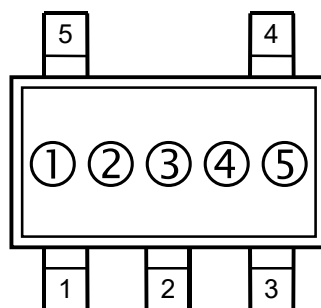

R1180N MARK SPECIFICATION TABLE (SOT-23-5)

Product Name	① ② ③	V _{SET}
R1180N121B	C 1 2	1.2 V
R1180N151B	C 1 5	1.5 V
R1180N181B	C 1 8	1.8 V
R1180N181B5	C 3 7	1.85 V
R1180N201B	C 2 0	2.0 V
R1180N231B	C 2 3	2.3 V
R1180N251B	C 2 5	2.5 V
R1180N281B	C 2 8	2.8 V
R1180N301B	C 3 0	3.0 V
R1180N331B	C 3 3	3.3 V
R1180N341B	C 3 4	3.4 V

Product Name	① ② ③	V _{SET}
R1180N121C	D 1 2	1.2 V
R1180N151C	D 1 5	1.5 V
R1180N181C	D 1 8	1.8 V
R1180N181C5	D 3 7	1.85V
R1180N201C	D 2 0	2.0 V
R1180N231C	D 2 3	2.3 V
R1180N251C	D 2 5	2.5 V
R1180N281C	D 2 8	2.8 V
R1180N301C	D 3 0	3.0 V
R1180N331C	D 3 3	3.3 V
R1180N341C	D 3 4	3.4 V

POWER DISSIPATION (SON1612-6)

The power dissipation of the package is dependent on PCB material, layout, and environmental conditions. The following conditions are used in this measurement.

Measurement Conditions

	Standard Test Land Pattern
Environment	Mounting on Board (Wind Velocity = 0 m/s)
Board Material	Glass Cloth Epoxy Plastic (Double-Sided Board)
Board Dimensions	40 mm × 40 mm × 1.6 mm
Copper Ratio	Top Side: Approx. 50% Bottom Side: Approx. 50%
Through-holes	φ 0.5 mm × 24 pcs

Measurement Result

(Ta = 25°C, Tjmax = 150°C)

	Standard Test Land Pattern
Power Dissipation	625 mW
Thermal Resistance	$\theta_{ja} = (150 - 25^\circ\text{C}) / 0.625 \text{ W} = 200^\circ\text{C/W}$

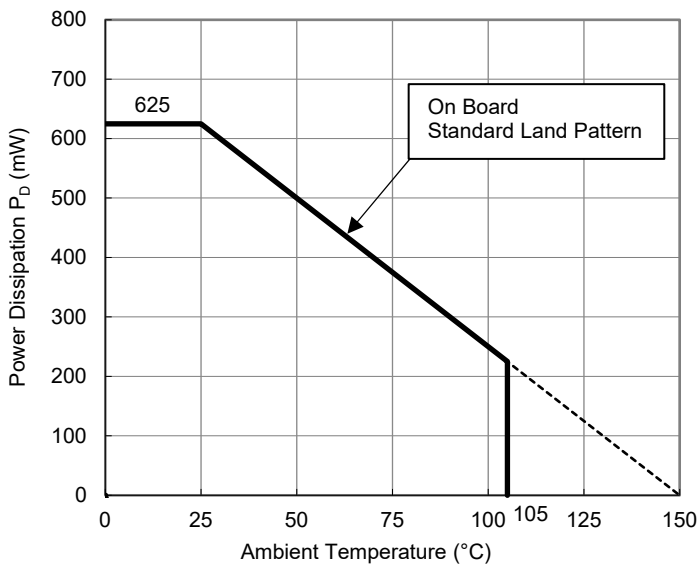

Power Dissipation vs. Ambient Temperature

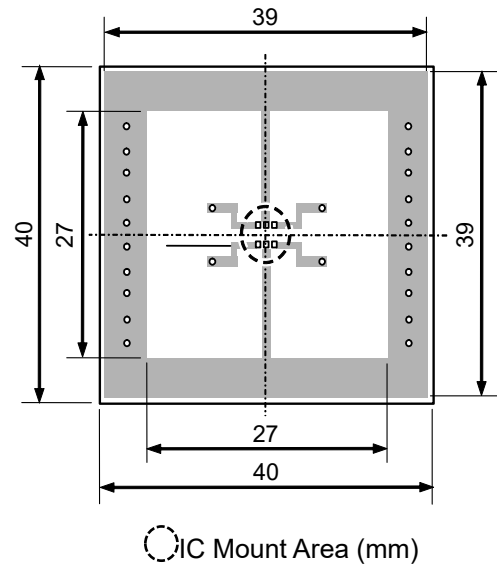

Measurement Board Pattern

PACKAGE DIMENSIONS (SON1612-6)

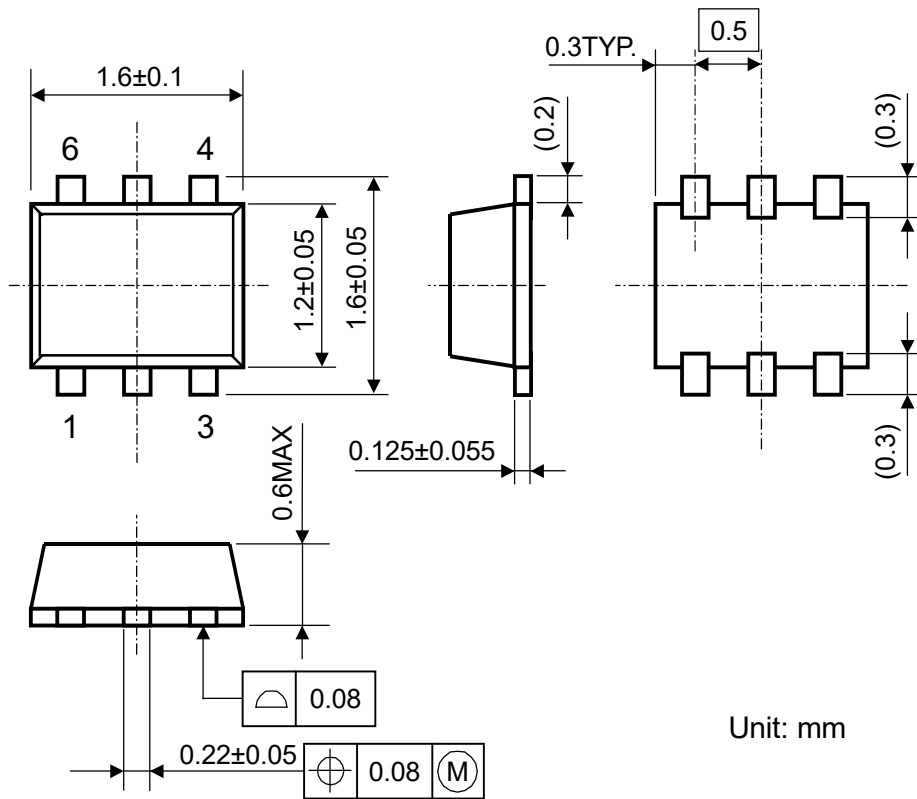

MARK SPECIFICATION (SON1612-6)

①②③④: Product Code ... Refer to *R1180D MARK SPECIFICATION TABLE*

⑤⑥: Lot Number ... Alphanumeric Serial Number

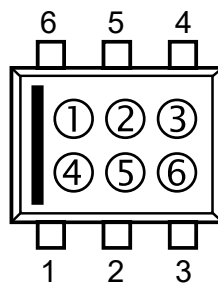

R1180D MARK SPECIFICATION TABLE (SON1612-6)

Product Name	①	②	③	④	V _{SET}
R1180D121B	G	1	2	B	1.2 V
R1180D151B	G	1	5	B	1.5 V
R1180D181B	G	1	8	B	1.8 V
R1180D181B5	G	0	0	B	1.85 V
R1180D201B	G	2	0	B	2.0 V
R1180D231B	G	2	3	B	2.3 V
R1180D251B	G	2	5	B	2.5 V
R1180D281B	G	2	8	B	2.8 V
R1180D301B	G	3	0	B	3.0 V
R1180D331B	G	3	3	B	3.3 V
R1180D341B	G	3	4	B	3.4 V

Product Name	①	②	③	④	V _{SET}
R1180D121C	G	1	2	C	1.2 V
R1180D151C	G	1	5	C	1.5 V
R1180D181C	G	1	8	C	1.8 V
R1180D181C5	G	0	0	C	1.85 V
R1180D201C	G	2	0	C	2.0 V
R1180D231C	G	2	3	C	2.3 V
R1180D251C	G	2	5	C	2.5 V
R1180D281C	G	2	8	C	2.8 V
R1180D301C	G	3	0	C	3.0 V
R1180D331C	G	3	3	C	3.3 V
R1180D341C	G	3	4	C	3.4 V

TYPICAL CHARACTERISTICS

Note: Typical Characteristics are intended to be used as reference data; they are not guaranteed.

1) Output Voltage vs. Output Current (Ta=25°C)

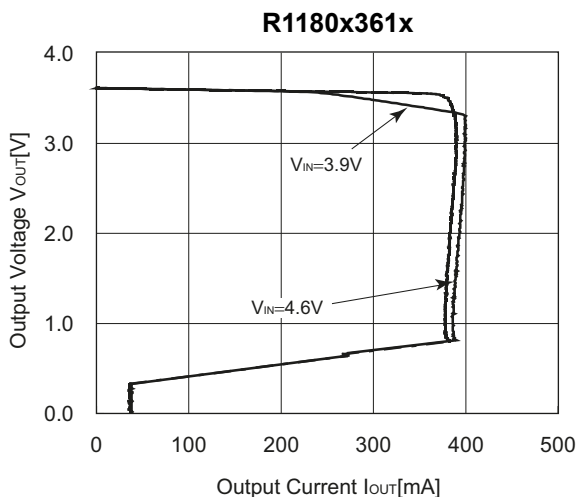
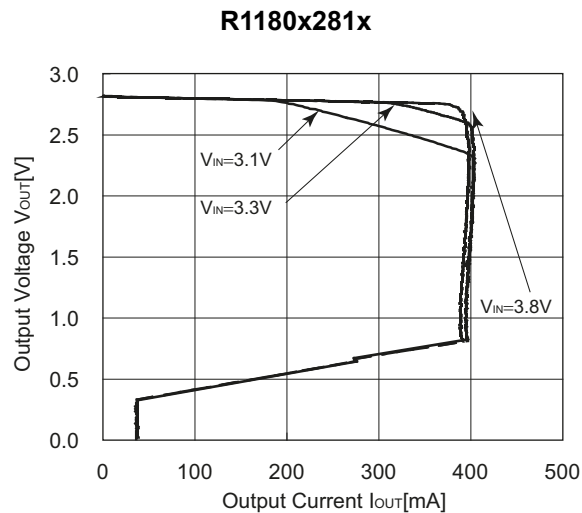
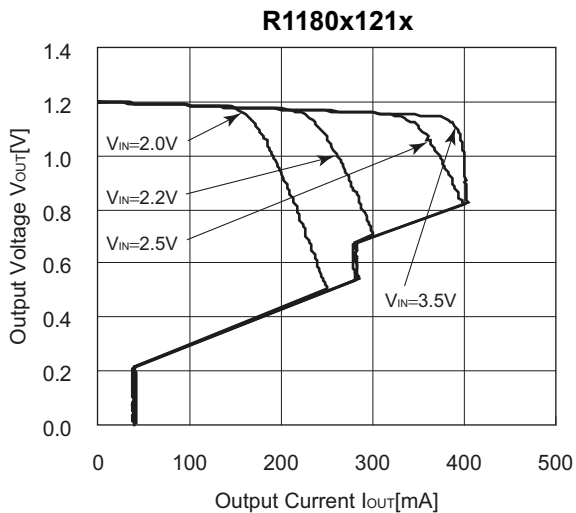

2) Output Voltage vs. Input Voltage (Ta=25°C)

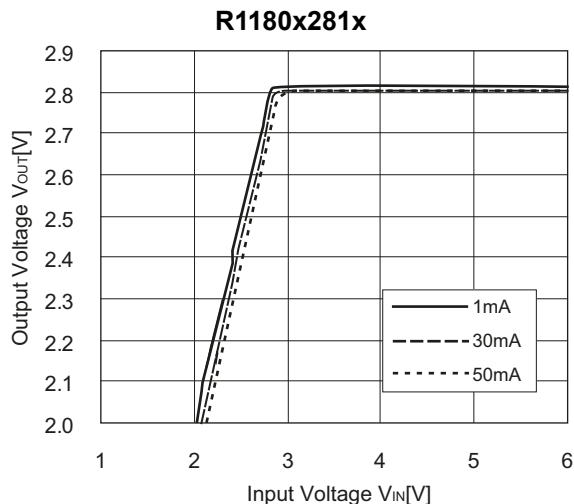
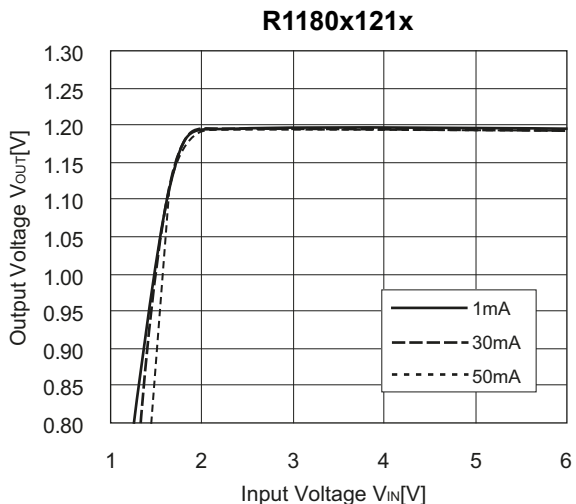

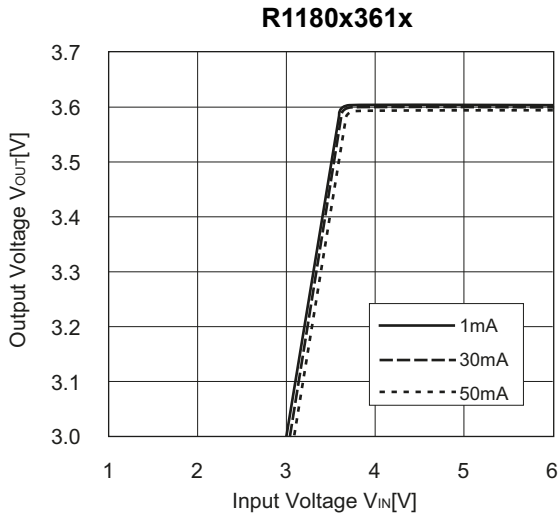

3) Dropout Voltage vs. Output Current

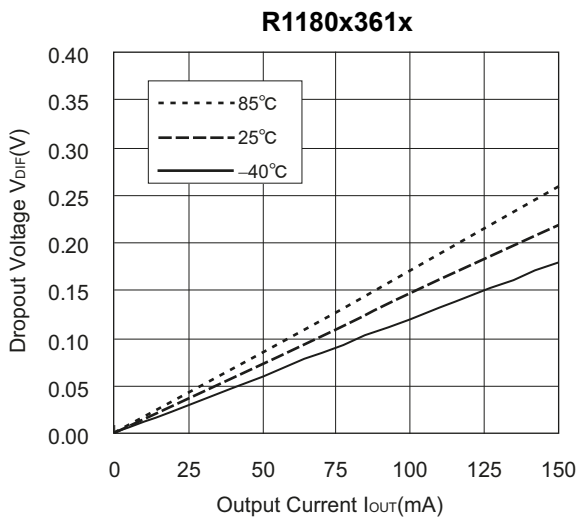
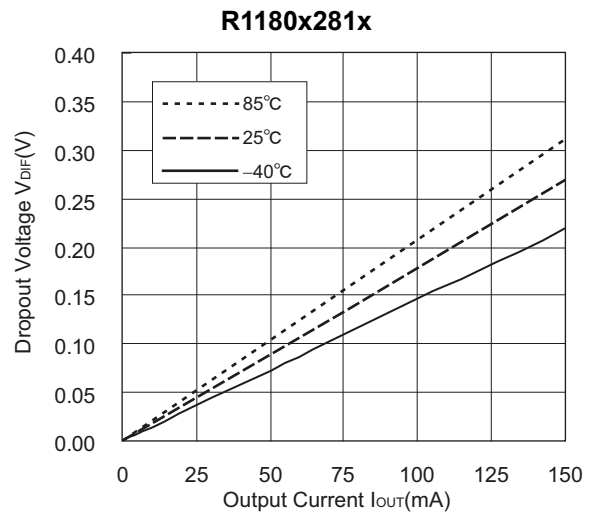
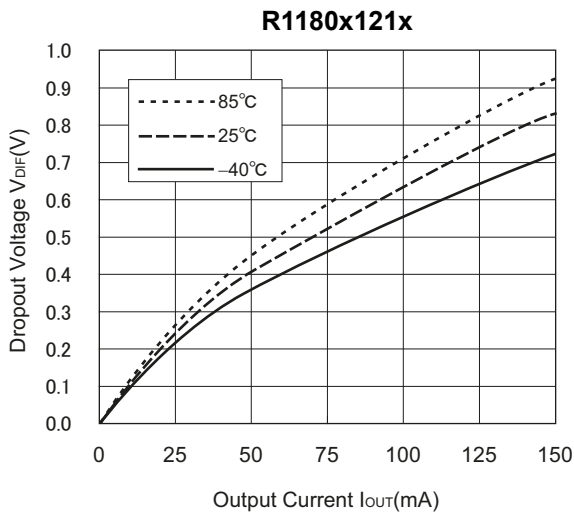

4) Output Voltage vs. Temperature ($I_{OUT}=30mA$)

R1180x121x ($V_{IN}=2.2V$)

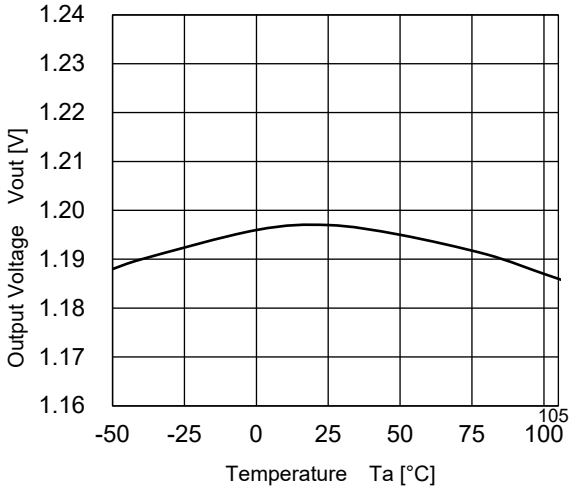

R1180x281x ($V_{IN}=3.8V$)

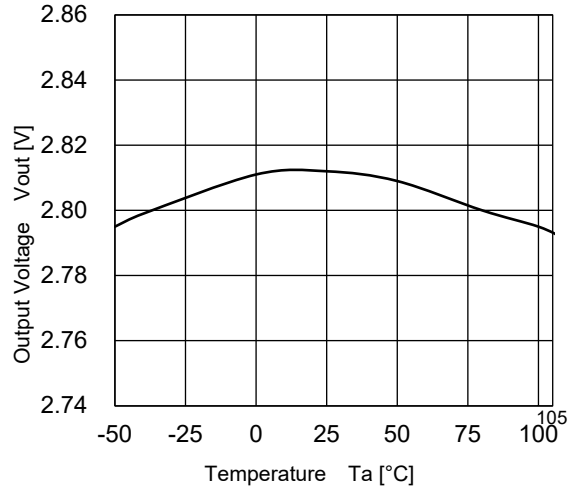

R1180x361x ($V_{IN}=4.6V$)

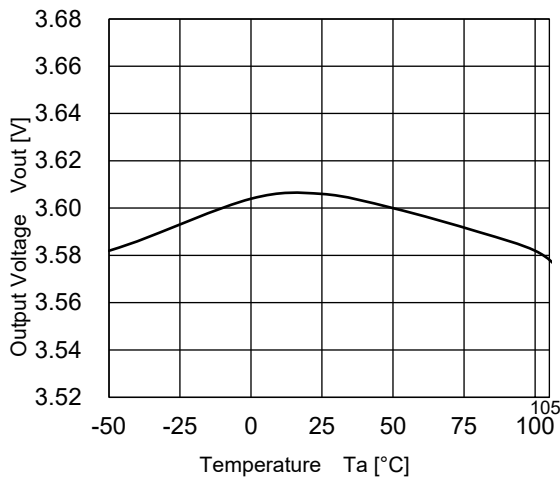

5) Supply Current vs. Input Voltage ($T_a=25^\circ C$)

R1180x121x

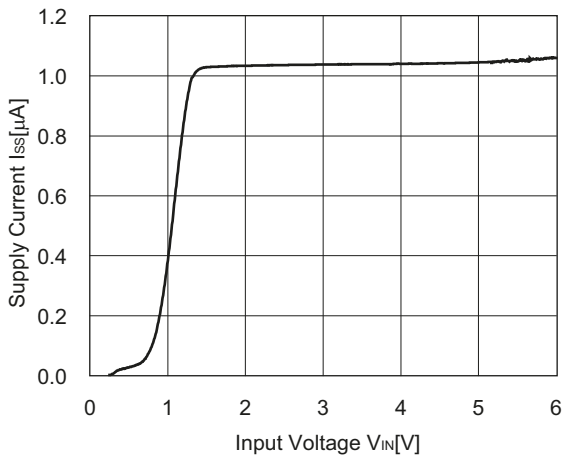

R1180x281x

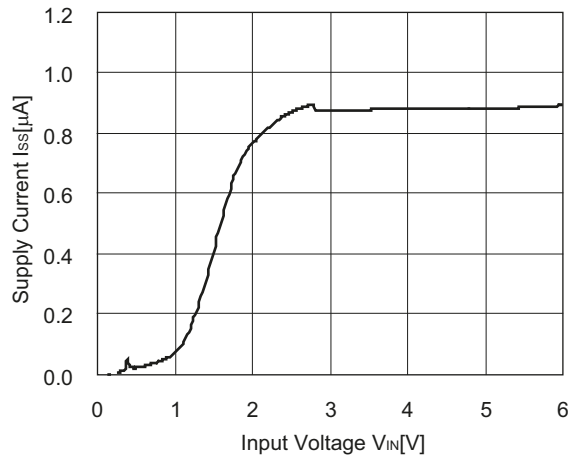

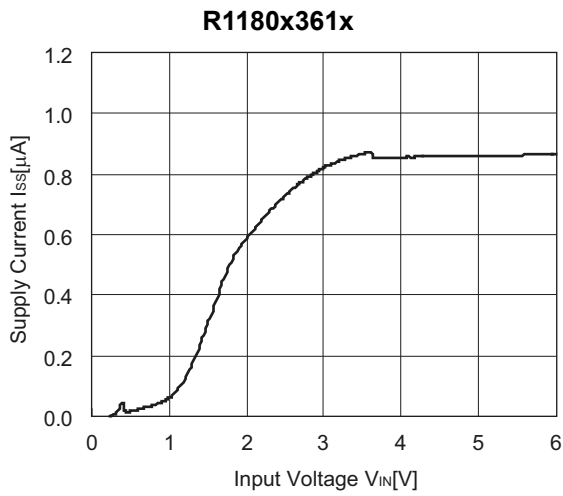

6) Supply Current vs. Temperature

R1180x121x ($V_{IN}=2.2V$)

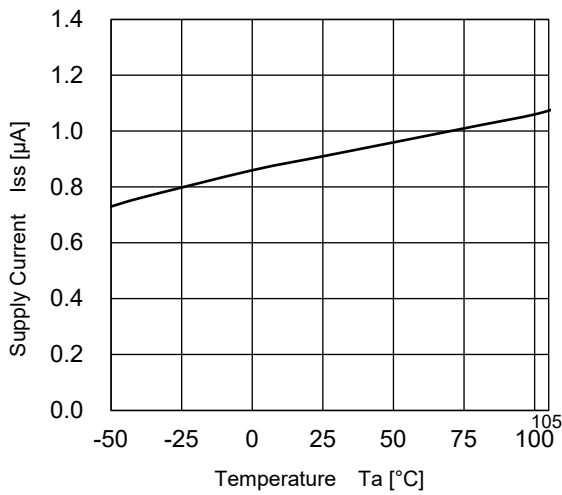

R1180x281x ($V_{IN}=3.8V$)

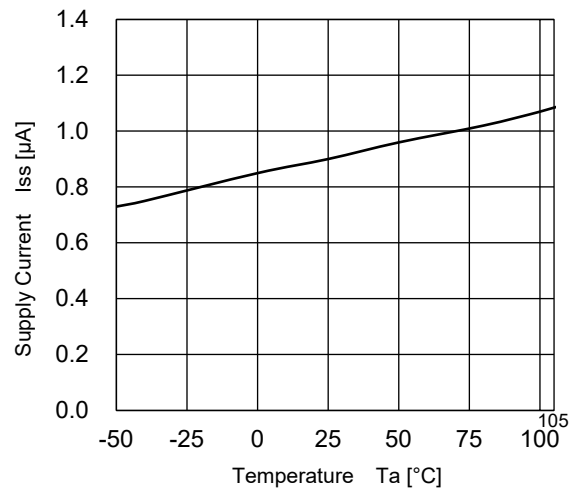

R1180x361x ($V_{IN}=4.6V$)

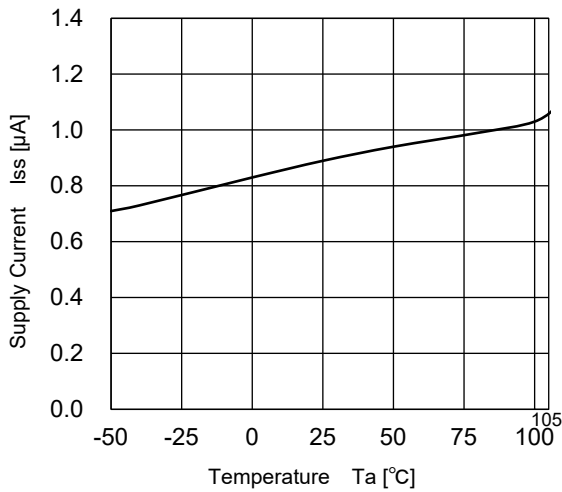

7) Dropout Voltage vs. Set Output Voltage (Ta=25°C)

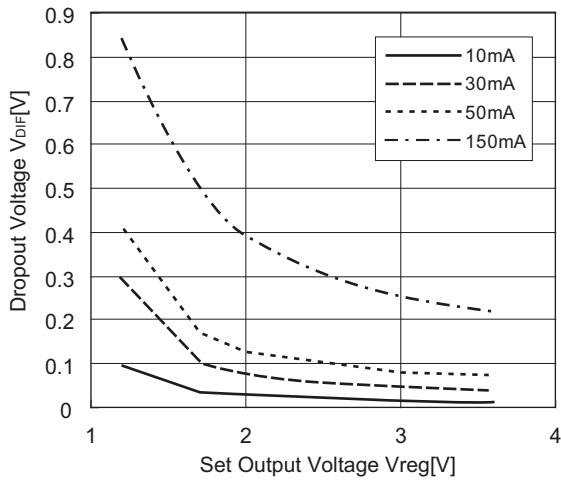

8) Ripple Rejection vs. Frequency (C1=none)

R1180x121x

V_{IN}=2.4V_{DC}+0.5p-p
C_{OUT}=Ceramic0.1μF

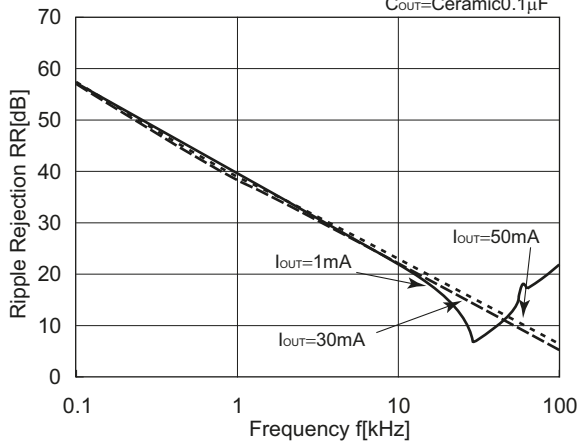

R1180x121x

V_{IN}=2.4V_{DC}+0.5p-p
C_{OUT}=Ceramic1μF

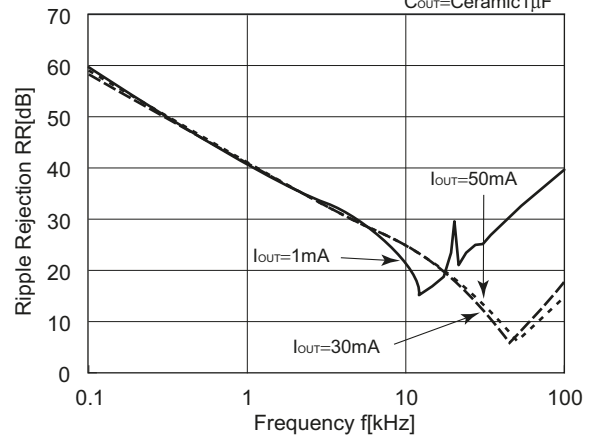

R1180x281x

V_{IN}=3.8V_{DC}+0.5p-p
C_{OUT}=Ceramic0.1μF

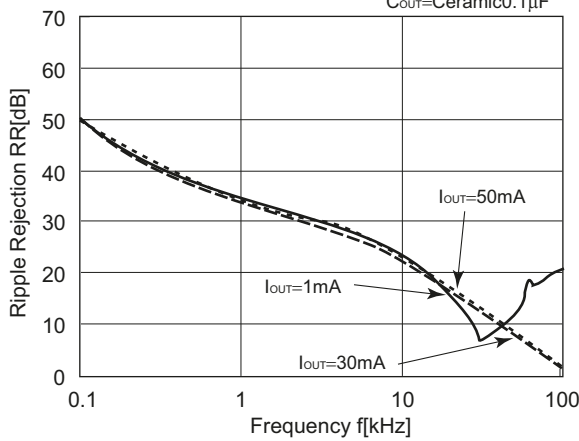

R1180x281x

V_{IN}=3.8V_{DC}+0.5p-p
C_{OUT}=Ceramic1μF

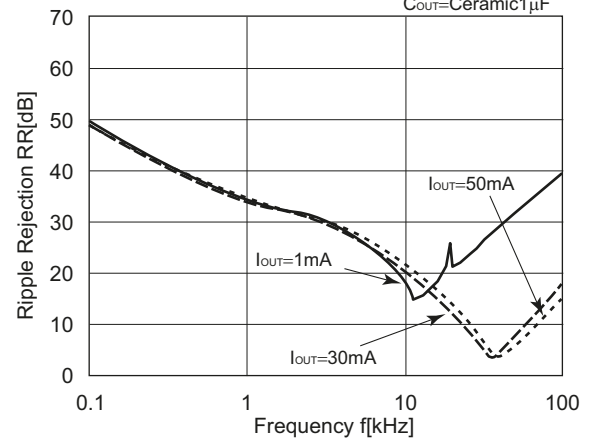

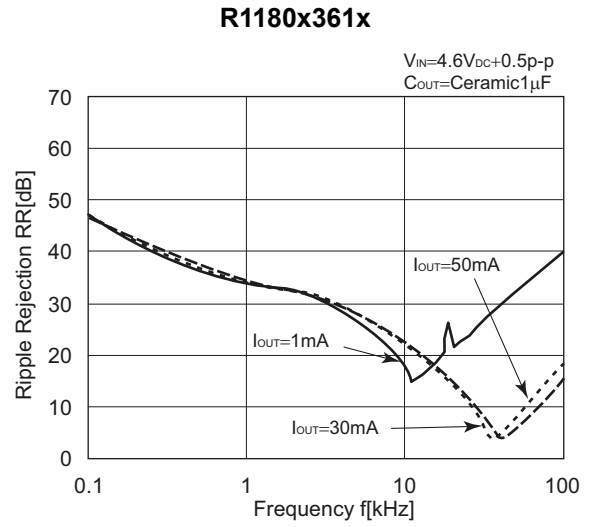
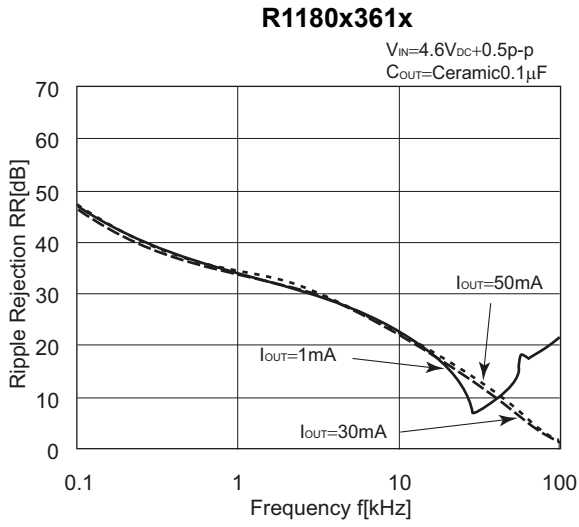

9) Ripple Rejection vs. Input Bias Voltage ($T_a=25^\circ C$, $C1=\text{none}$, $C2=\text{Ceramic}0.1\mu F$)

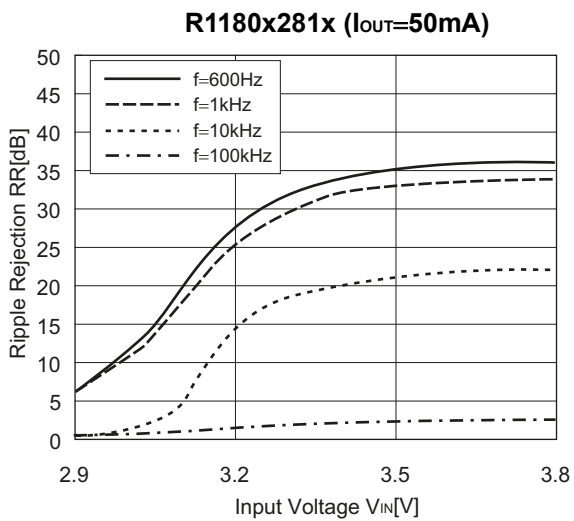
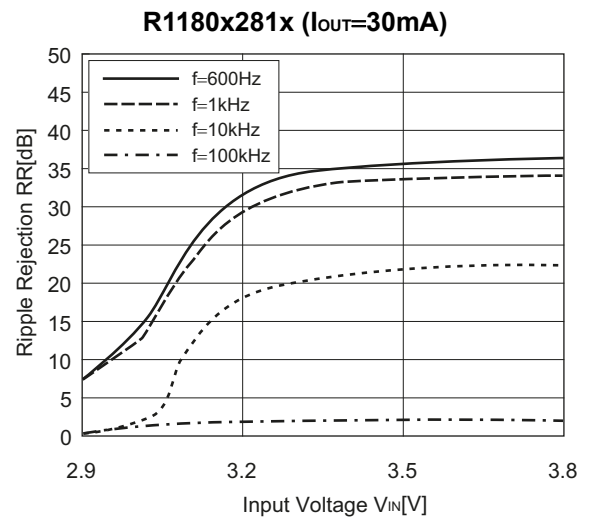
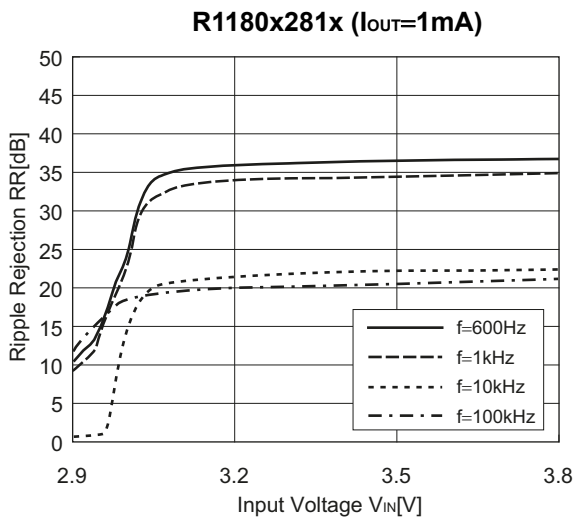

10) Input Transient Response (C1=none, $t_r=t_f=5\mu s$)

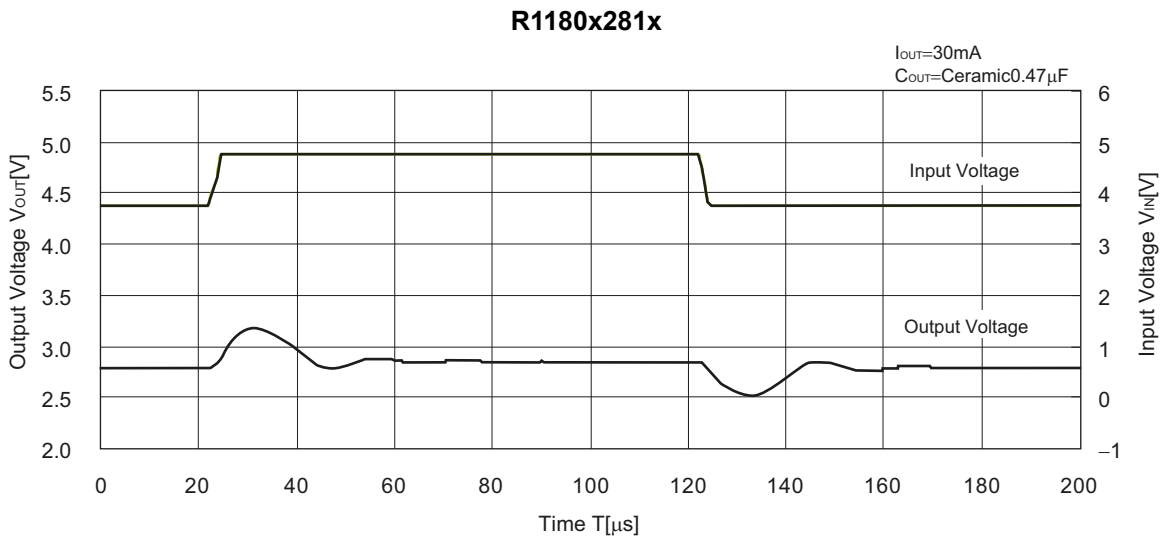
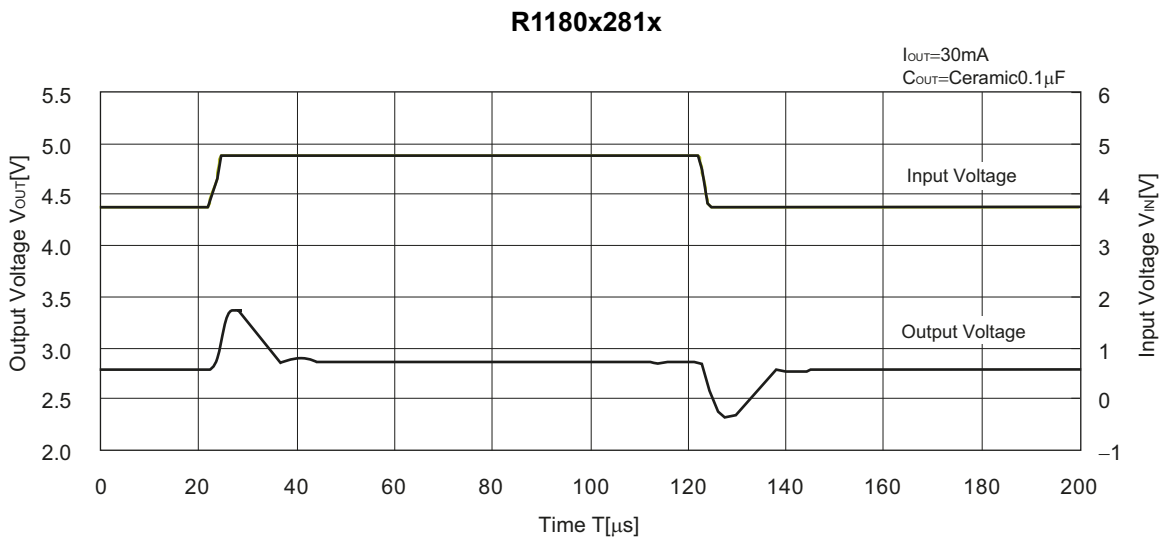
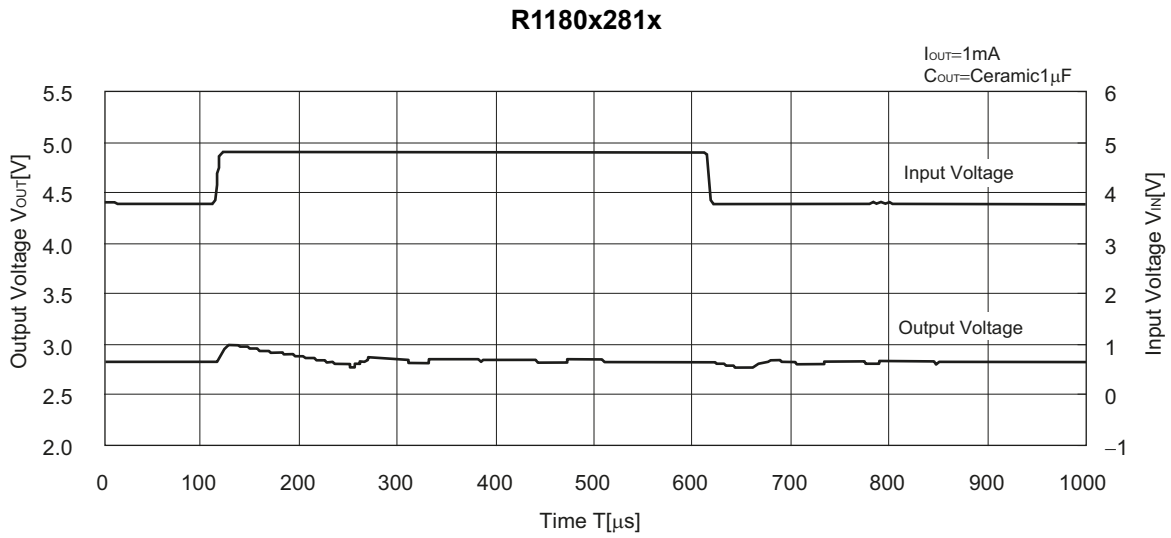

R1180x281x

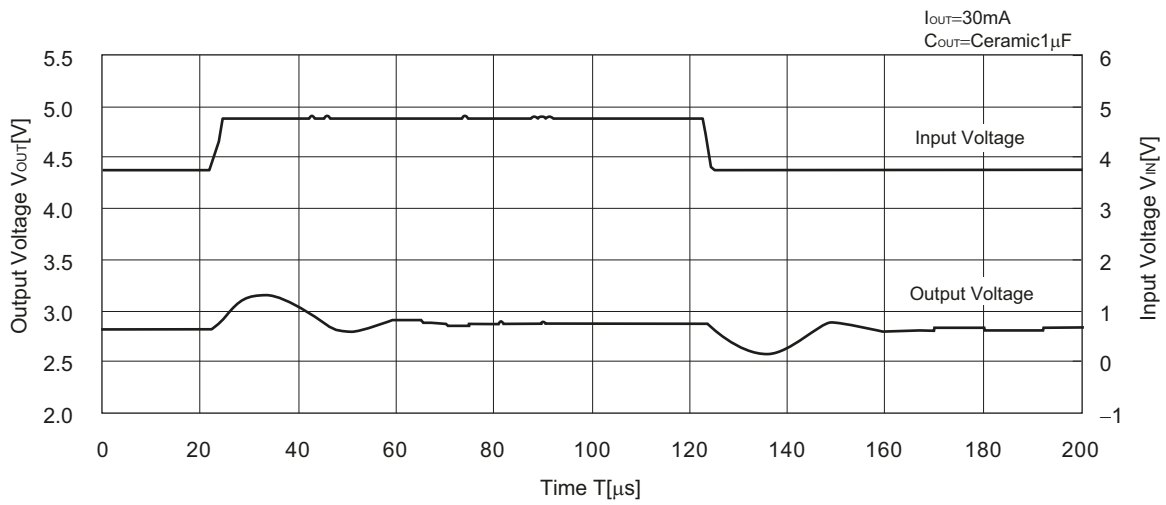

11) Load Transient Response ($t_r=t_f=0.5\mu s$ $V_{IN}=3.8V$)

R1180x281x

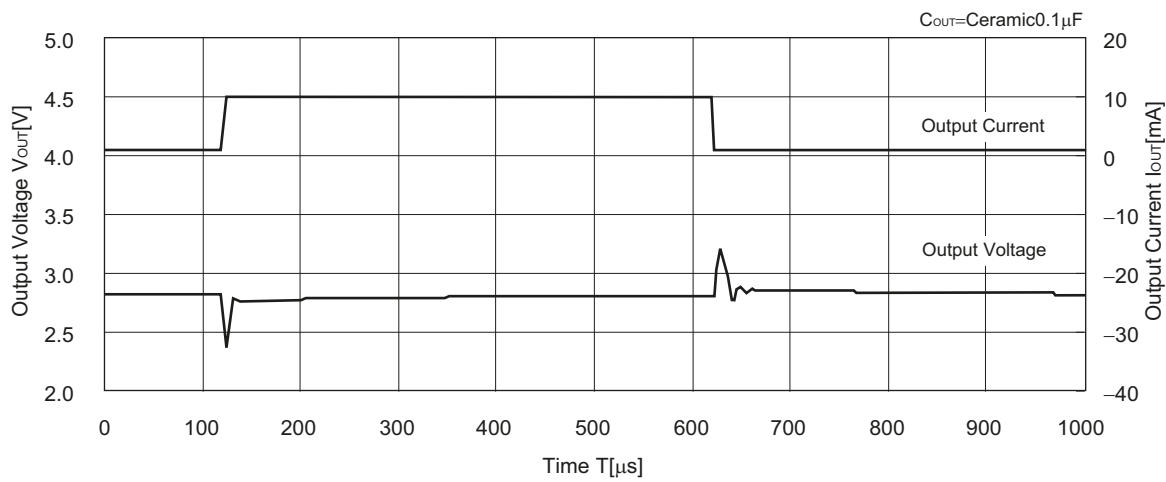

R1180x281x

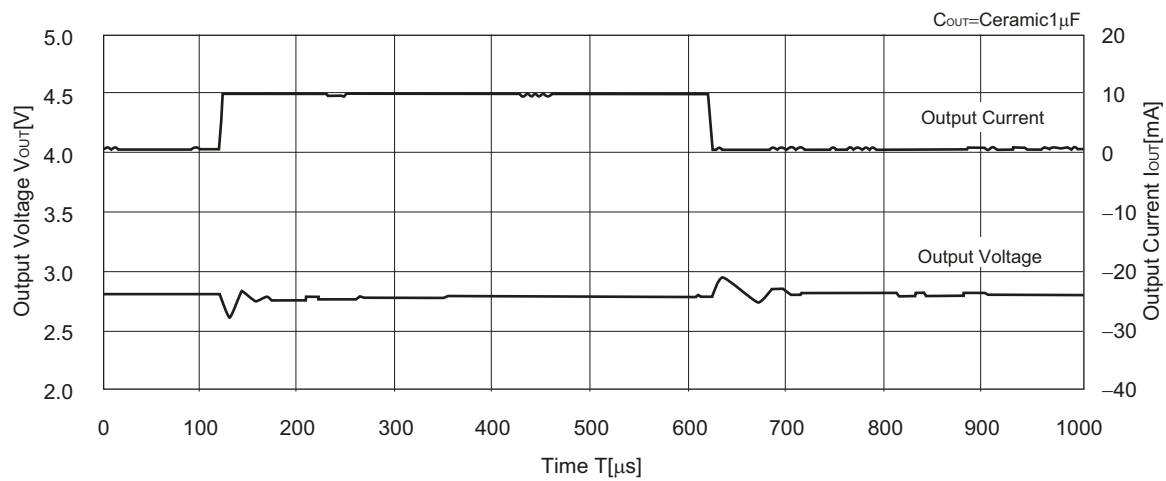

R1180x281x

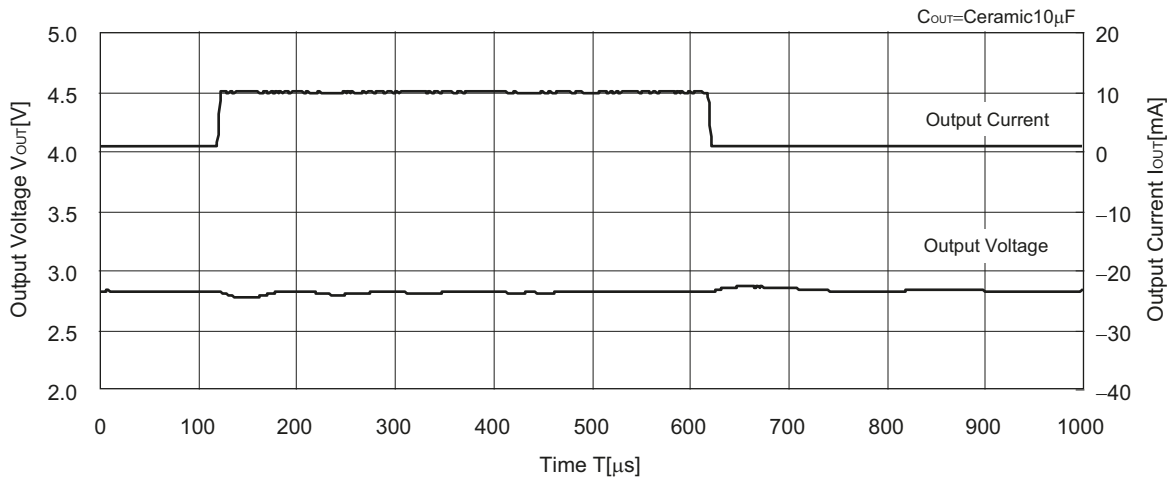

R1180x281x

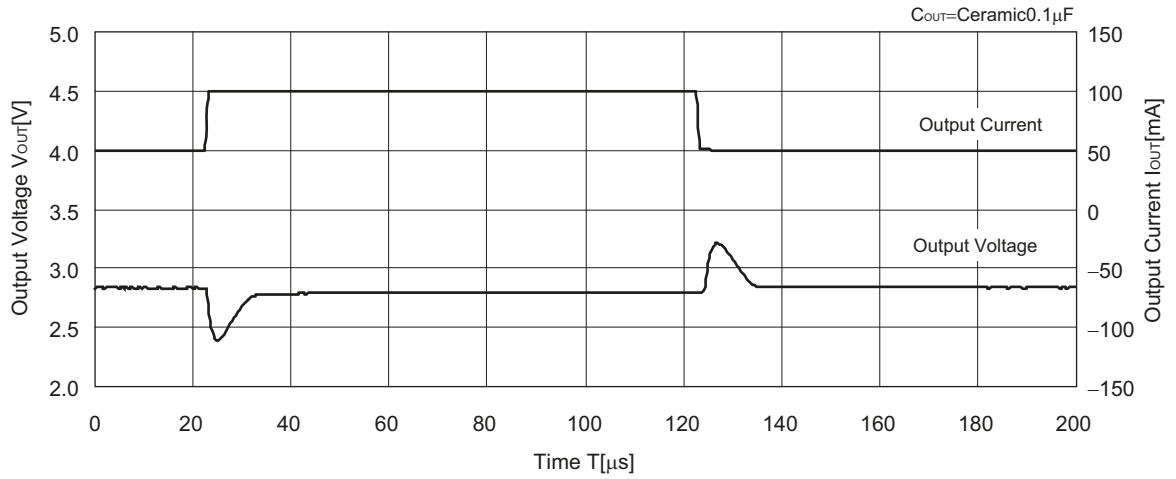

R1180x281x

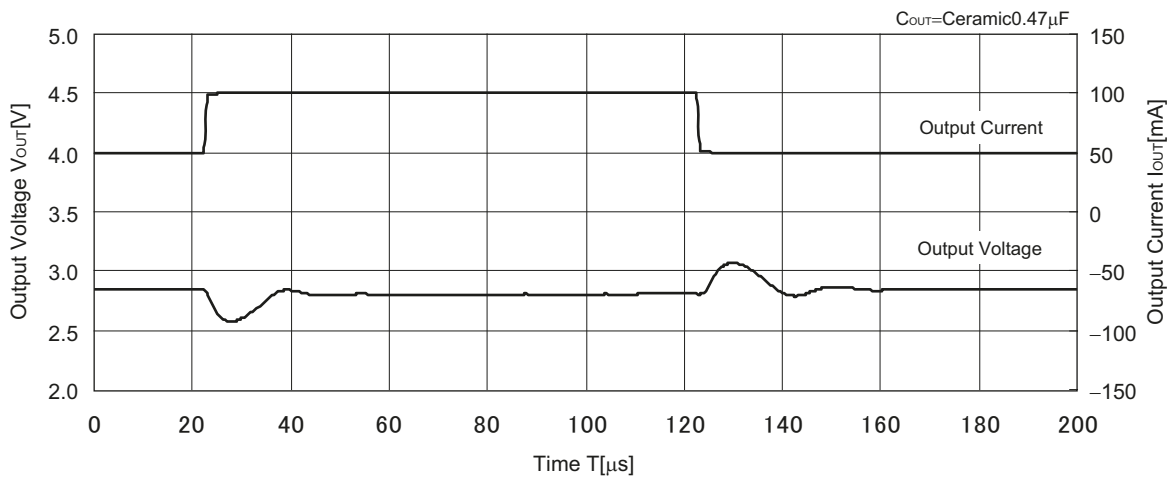

R1180x281x

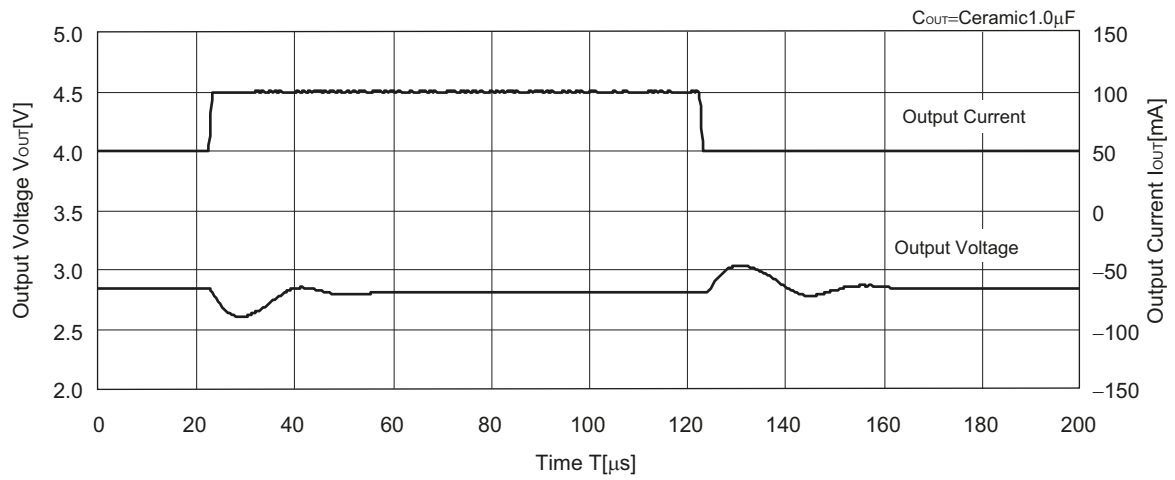

ESR vs. Output Current

The relations between I_{OUT} (Output Current) and ESR of an output capacitor are shown below. The conditions when the white noise level is under $40\mu V$ (Avg.) are marked as the hatched area in the graph.

<Measurement conditions>

- (1) $V_{IN}=V_{OUT}+1V$
- (2) Frequency Band: 10Hz to 2MHz (BW=30Hz)
- (3) Temperature: $-40^{\circ}C$ to $85^{\circ}C$

R1180x121x

C1 = Ceramic 1.0 μ A, C2 = Ceramic 0.1 μ F

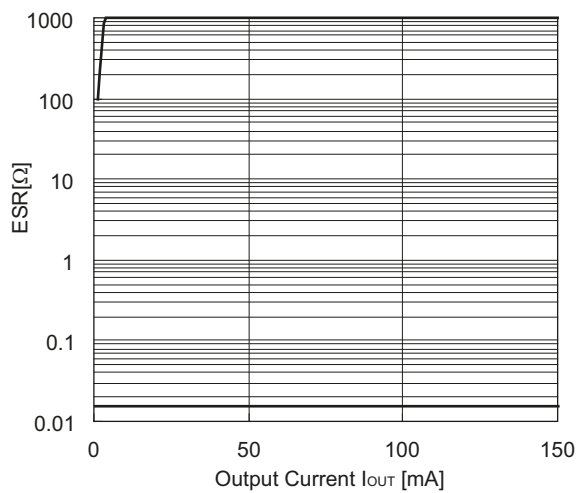

R1180x281x

C1 = Ceramic 1.0 μ A, C2 = Ceramic 0.1 μ F

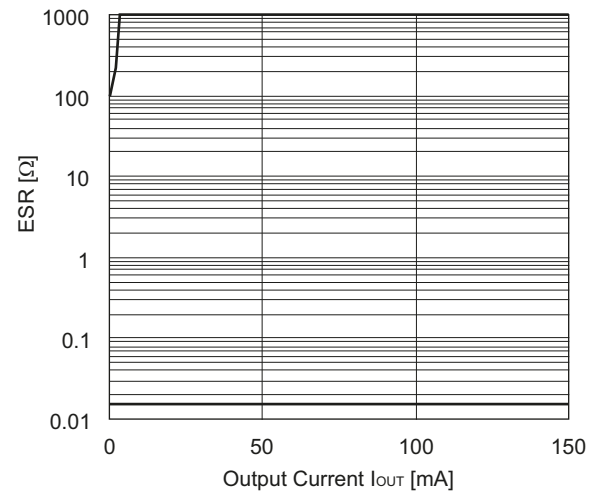

1. The products and the product specifications described in this document are subject to change or discontinuation of production without notice for reasons such as improvement. Therefore, before deciding to use the products, please refer to our sales representatives for the latest information thereon.
2. The materials in this document may not be copied or otherwise reproduced in whole or in part without the prior written consent of us.
3. This product and any technical information relating thereto are subject to complementary export controls (so-called KNOW controls) under the Foreign Exchange and Foreign Trade Law, and related politics ministerial ordinance of the law. (Note that the complementary export controls are inapplicable to any application-specific products, except rockets and pilotless aircraft, that are insusceptible to design or program changes.) Accordingly, when exporting or carrying abroad this product, follow the Foreign Exchange and Foreign Trade Control Law and its related regulations with respect to the complementary export controls.
4. The technical information described in this document shows typical characteristics and example application circuits for the products. The release of such information is not to be construed as a warranty of or a grant of license under our or any third party's intellectual property rights or any other rights.
5. The products listed in this document are intended and designed for use as general electronic components in standard applications (office equipment, telecommunication equipment, measuring instruments, consumer electronic products, amusement equipment etc.). Those customers intending to use a product in an application requiring extreme quality and reliability, for example, in a highly specific application where the failure or misoperation of the product could result in human injury or death should first contact us.
 - Aerospace Equipment
 - Equipment Used in the Deep Sea
 - Power Generator Control Equipment (nuclear, steam, hydraulic, etc.)
 - Life Maintenance Medical Equipment
 - Fire Alarms / Intruder Detectors
 - Vehicle Control Equipment (automotive, airplane, railroad, ship, etc.)
 - Various Safety Devices
 - Traffic control system
 - Combustion equipment

In case your company desires to use this product for any applications other than general electronic equipment mentioned above, make sure to contact our company in advance. Note that the important requirements mentioned in this section are not applicable to cases where operation requirements such as application conditions are confirmed by our company in writing after consultation with your company.

6. We are making our continuous effort to improve the quality and reliability of our products, but semiconductor products are likely to fail with certain probability. In order to prevent any injury to persons or damages to property resulting from such failure, customers should be careful enough to incorporate safety measures in their design, such as redundancy feature, fire containment feature and fail-safe feature. We do not assume any liability or responsibility for any loss or damage arising from misuse or inappropriate use of the products.
7. The products have been designed and tested to function within controlled environmental conditions. Do not use products under conditions that deviate from methods or applications specified in this datasheet. Failure to employ the products in the proper applications can lead to deterioration, destruction or failure of the products. We shall not be responsible for any bodily injury, fires or accident, property damage or any consequential damages resulting from misuse or misapplication of the products.
8. **Quality Warranty**
 - 8-1. **Quality Warranty Period**

In the case of a product purchased through an authorized distributor or directly from us, the warranty period for this product shall be one (1) year after delivery to your company. For defective products that occurred during this period, we will take the quality warranty measures described in section 8-2. However, if there is an agreement on the warranty period in the basic transaction agreement, quality assurance agreement, delivery specifications, etc., it shall be followed.
 - 8-2. **Quality Warranty Remedies**

When it has been proved defective due to manufacturing factors as a result of defect analysis by us, we will either deliver a substitute for the defective product or refund the purchase price of the defective product.

Note that such delivery or refund is sole and exclusive remedies to your company for the defective product.
 - 8-3. **Remedies after Quality Warranty Period**

With respect to any defect of this product found after the quality warranty period, the defect will be analyzed by us. On the basis of the defect analysis results, the scope and amounts of damage shall be determined by mutual agreement of both parties. Then we will deal with upper limit in Section 8-2. This provision is not intended to limit any legal rights of your company.
9. Anti-radiation design is not implemented in the products described in this document.
10. The X-ray exposure can influence functions and characteristics of the products. Confirm the product functions and characteristics in the evaluation stage.
11. WLCSP products should be used in light shielded environments. The light exposure can influence functions and characteristics of the products under operation or storage.
12. Warning for handling Gallium and Arsenic (GaAs) products (Applying to GaAs MMIC, Photo Reflector). These products use Gallium (Ga) and Arsenic (As) which are specified as poisonous chemicals by law. For the prevention of a hazard, do not burn, destroy, or process chemically to make them as gas or power. When the product is disposed of, please follow the related regulation and do not mix this with general industrial waste or household waste.
13. Please contact our sales representatives should you have any questions or comments concerning the products or the technical information.



Nisshinbo Micro Devices Inc.

Official website

<https://www.nisshinbo-microdevices.co.jp/en/>

Purchase information

<https://www.nisshinbo-microdevices.co.jp/en/buy/>