

### FEATURES (All Devices)

- Significant Performance Advantages over LF155, 156 and 157 Devices.
- Low Input Offset Voltage ..... 500 $\mu$ V Max
- Low Input Offset Voltage Drift ..... 2.0 $\mu$ V/ $^{\circ}$ C
- Minimum Slew Rate Guaranteed on All Models
- Temperature-Compensated Input Bias Currents
- Guaranteed Input Bias Current @ 125 $^{\circ}$ C
- Bias Current Specified WARMED UP Over Temperature
- Internal Compensation
- Low Input Noise Current ..... 0.01 $\mu$ A/ $\sqrt$ Hz
- High Common-Mode Rejection Ratio ..... 100dB
- Models With MIL-STD-883 Processing Available
- 125 $^{\circ}$ C Temperature Tested DICE

### OP-15

- 156 Speed With 155 Dissipation ..... (50mW Typ)
- Wide Bandwidth ..... 6MHz
- High Slew Rate ..... 13V/ $\mu$ s
- Fast Settling to  $\pm$ 0.1% ..... 1200ns
- Available in Die Form

### OP-16

- Higher Slew Rate ..... 25V/ $\mu$ s
- Faster Settling to  $\pm$ 0.1% ..... 900ns
- Wider Bandwidth ..... 8MHz
- Available in Die Form

### OP-17

- Highest Slew Rate ..... 60V/ $\mu$ s
- Fastest Settling to  $\pm$ 0.1% ..... 600ns
- Highest Gain Bandwidth Product ( $A_{VCL} = 5$  Min) ..... 30MHz
- Available in Die Form

### GENERAL DESCRIPTION

The PMI JFET-input series of devices offer clear advantages over industry-generic devices and are superior in both cost and performance to many dielectrically-isolated and hybrid op amps. All devices offer offset voltages as low as 0.5mV with  $TCV_{OS}$  guaranteed to 5 $\mu$ V/ $^{\circ}$ C. A unique input bias cancellation circuit reduces the  $I_B$  by a factor of 10 over conventional designs. In addition, PMI specifies  $I_B$  and  $I_{OS}$  with the devices warmed up and operating at 25 $^{\circ}$ C ambient.

These devices were designed to provide real precision performance along with high speed. Although they can be nulled, the design objective was to provide low offset-voltage without nulling. Systems generally become more cost effective as the number of trim circuits is decreased. PMI achieves this performance by use of an improved Bipolar compatible JFET process coupled with on-chip, zener-zap offset trimming.

The OP-15 provides an excellent combination of high speed and low input offset voltage. In addition, the OP-15 offers the speed of the 156A op amp with the power dissipation of a 155A. The combination of a low input offset voltage of 500 $\mu$ V, slew rate of 13V/ $\mu$ s, and settling time of 1200ns to 0.1% makes the OP-15 an op amp of both precision and speed. The additional features of low supply current coupled with an input bias current of 9nA at 125 $^{\circ}$ C ambient (hot junction) temperature makes the OP-15 ideal for a wide range of applications.

The OP-16 features a slew rate of 25V/ $\mu$ s and a settling time of 900ns to 0.1% which represents a significant improvement in speed over the 156. Also, the OP-16 has all the DC features of the OP-15.

The OP-17 has a slew rate of 60V/ $\mu$ s and is the best choice for applications requiring high closed-loop gain with high speed. See the OP-42 data sheet for unity gain applications and the OP-215 data sheet for a dual configuration of the OP-15.

### SIMPLIFIED SCHEMATIC

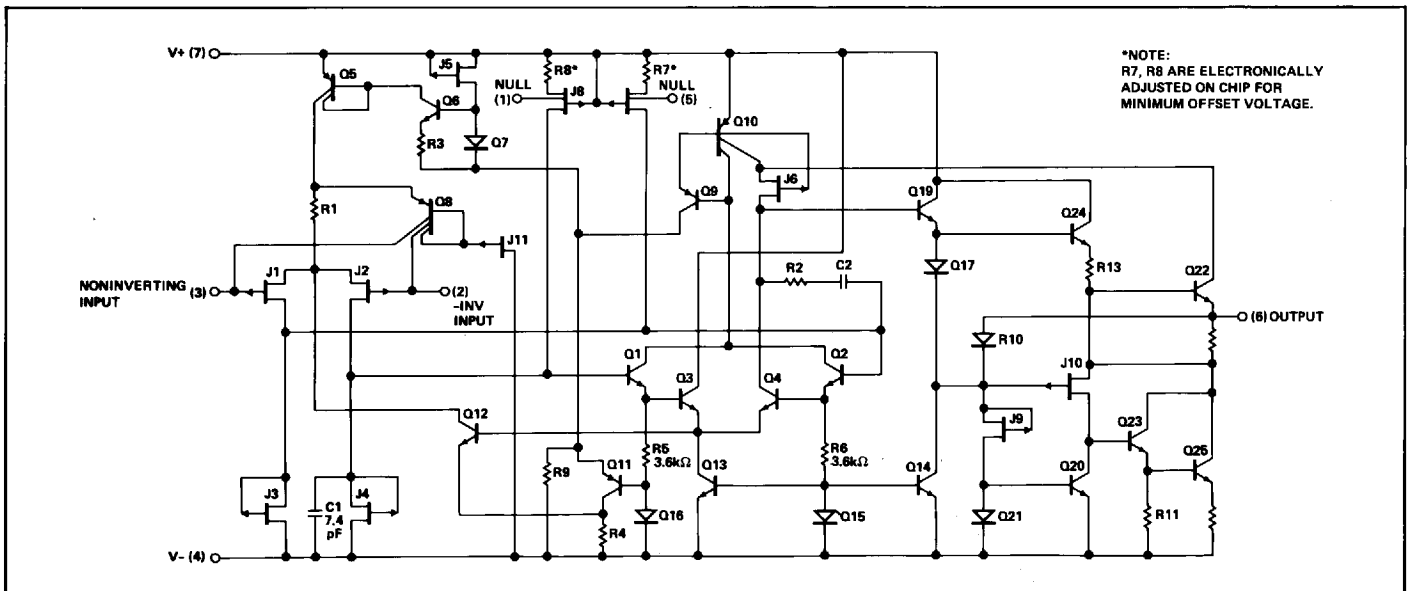

# OP-15/OP-16/OP-17

## ORDERING INFORMATION †

T <sub>a</sub> = +25°C V <sub>OS</sub> MAX (mV)	PACKAGE				OPERATING TEMPERATURE RANGE
	TO-99	CERDIP 8-PIN	PLASTIC 8-PIN	SO 8-PIN	
0.5	OP15AJ*	OP15AZ*	-	-	MIL
	OP16AJ*	-	-	-	
	OP17AJ*	OP17AZ*	-	-	
0.5	OP15EJ	OP15EZ	-	-	COM
	OP16EJ	OP16EZ	-	-	
	OP17EJ	OP17EZ	-	-	
1.0	OP15BJ/883	OP15BZ/883	-	-	MIL
	OP16BJ/883	OP16BZ/883	-	-	
	OP17BJ*	OP17BZ	-	-	
1.0	OP15FJ	OP15FZ	OP15FP	-	COM
	OP16FJ	OP16FZ	OP16FP	-	
	-	-	OP17FP	-	
3.0	-	OP17CZ/883	-	-	MIL
	OP17CJ/883C	-	-	-	
3.0	OP15GJ	OP15GZ	OP15GP	OP15GS	XIND
	OP16GJ	OP16GZ	OP16GP	OP16GS	
	OP17GJ	OP17GZ	OP17GP	OP17GS	

\* For devices processed in total compliance to MIL-STD-883, add /883 after part number. Consult factory for 883 data sheet.

† Burn-in is available on commercial and industrial temperature range parts in CerDIP, plastic DIP, and TO-can packages.

## ABSOLUTE MAXIMUM RATINGS (Note 1)

### Supply Voltage

All Devices Except C, G (Packaged) & GR Grades ..... ±22V  
 C, G (Packaged) & GR Grades ..... ±18V

### Operating Temperature

A, B, & C Grades ..... -55°C to +125°C  
 E & F Grades ..... 0°C to +70°C  
 G Grade ..... -40°C to +85°C

Maximum Junction Temperature ..... +150°C

DICE Junction Temperature (T<sub>j</sub>) ..... -65°C to +150°C

### Differential Input Voltage

All Devices Except C, G (Packaged) & GR Grades ..... ±40V  
 C, G (Packaged) & GR Grades ..... ±30V

### Input Voltage (Note 2)

All Devices Except C, G (Packaged) & GR Grades ..... ±20V  
 C, G (Packaged) & GR Grades ..... ±16V

### Input Voltage

OP-15A, OP-15B, OP-15E, OP-15F ..... ±20V  
 OP-15G ..... ±16V  
 OP-16A, OP-16B, OP-16E, OP-16F ..... ±20V  
 OP-16C, OP-16G ..... ±16V  
 OP-17A, OP-17B, OP-17E, OP-17F ..... ±20V  
 OP-17C, OP-17G ..... ±16V

Output Short-Circuit Duration ..... Indefinite

Storage Temperature/Range ..... -65°C to +150°C

Lead Temperature Range (Soldering, 60 sec) ..... +300°C

PACKAGE TYPE	θ <sub>JA</sub> (Note 3)	θ <sub>JC</sub>	UNITS
TO-99 (J)	150	18	°C/W
8-Pin Hermetic DIP (Z)	148	16	°C/W
8-Pin Plastic DIP (P)	103	43	°C/W
8-Pin SO (S)	158	43	°C/W

### NOTES:

1. Absolute maximum ratings apply to both DICE and packaged parts, unless otherwise noted.
2. Unless otherwise specified the absolute maximum negative input voltage is equal to the negative power-supply voltage.
3. θ<sub>JA</sub> is specified for worst case mounting conditions, i.e., θ<sub>JA</sub> is specified for device in socket for TO, CerDIP and P-DIP packages; θ<sub>JA</sub> is specified for device soldered to printed circuit board for SO package.

## PIN CONNECTIONS

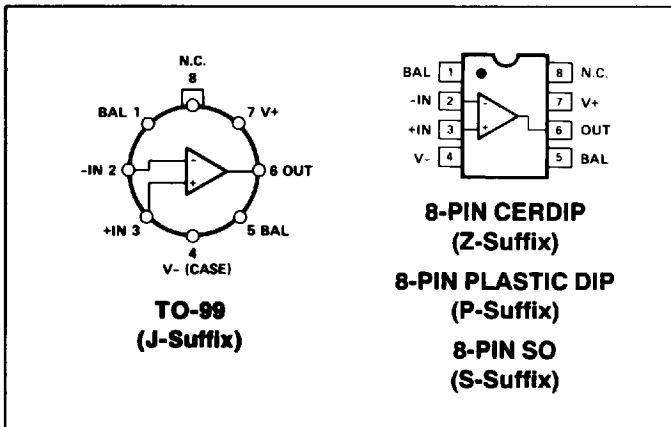

## BURN-IN CIRCUIT

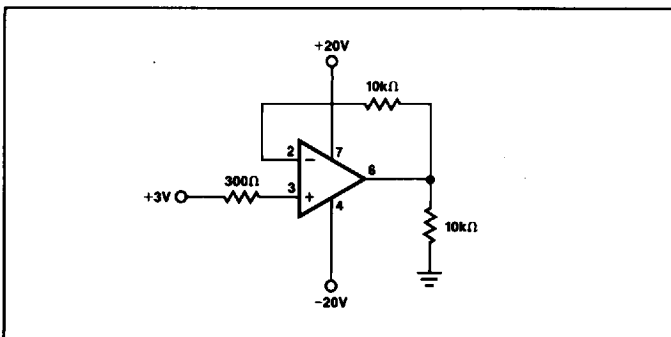

# OP-15/OP-16/OP-17

**ELECTRICAL CHARACTERISTICS** at  $V_S = \pm 15V$ ,  $T_A = 25^\circ C$ , unless otherwise noted.

PARAMETER	SYMBOL	CONDITIONS	OP-15A/E OP-16A/E OP-17A/E			OP-15B/F OP-16B/F OP-17B/F			OP-15G OP-16C/G OP-17C/G			UNITS	
			MIN	TYP	MAX	MIN	TYP	MAX	MIN	TYP	MAX		
Input Offset Voltage	$V_{OS}$	$R_S = 50\Omega$	—	0.2	0.5	—	0.4	1.0	—	0.5	3.0	mV	
Input Offset Current	$I_{OS}$	$T_J = 25^\circ C$ (Note 1) Device Operating	OP-15	—	3	10	—	6	20	—	12	50	pA
		$T_J = 25^\circ C$ (Note 1) Device Operating	OP-16/OP-17	—	5	22	—	10	40	—	20	100	
Input Bias Current	$I_B$	$T_J = 25^\circ C$ (Note 1) Device Operating	OP-15	—	$\pm 15$	$\pm 50$	—	$\pm 30$	$\pm 100$	—	$\pm 60$	$\pm 200$	pA
		$T_J = 25^\circ C$ (Note 1) Device Operating	OP-16/OP-17	—	$\pm 18$	$\pm 110$	—	$\pm 40$	$\pm 200$	—	$\pm 80$	$\pm 400$	
Input Resistance	$R_{IN}$		—	$10^{12}$	—	—	$10^{12}$	—	—	$10^{12}$	—	$\Omega$	
Large-Signal Voltage Gain	$A_{VO}$	$R_L \geq 2k\Omega$ $V_O = \pm 10V$		100	240	—	75	220	—	50	200	—	V/mV
Output Voltage Swing	$V_O$	$R_L = 10k\Omega$		$\pm 12$	$\pm 13$	—	$\pm 12$	$\pm 13$	—	$\pm 12$	$\pm 13$	—	V
		$R_L = 2k\Omega$		$\pm 11$	$\pm 12.7$	—	$\pm 11$	$\pm 12.7$	—	$\pm 11$	$\pm 12.7$	—	V
Supply Current	$I_{SV}$		OP-15	—	2.7	4.0	—	2.7	4.0	—	2.8	5.0	mA
			OP-16/OP-17	—	4.6	7.0	—	4.6	7.0	—	4.8	8.0	
Slew Rate	SR	$A_{VCL} = +1$ (Note 3)	OP-15	10	13	—	7.5	11	—	5	9	—	V/ $\mu s$
		$A_{VCL} = +5$ (Note 3)	OP-16	18	25	—	12	21	—	9	17	—	
		$A_{VCL} = +5$ (Note 3)	OP-17	45	60	—	35	50	—	25	40	—	
Gain Bandwidth Product	GBW	(Note 3)	OP-15	4.0	6.0	—	3.5	5.7	—	3.0	5.4	—	MHz
			OP-16	6.0	8.0	—	5.5	7.6	—	5.0	7.2	—	
			OP-17	20	30	—	15	28	—	11	26	—	
Closed-Loop Bandwidth	CLBW	$A_{VCL} = +1$	OP-15	—	14	—	—	13	—	—	12	—	MHz
		$A_{VCL} = +5$	OP-16	—	19	—	—	18	—	—	17	—	
		$A_{VCL} = +5$	OP-17	—	11	—	—	10	—	—	9	—	
Settling Time	$t_S$	to 0.01%	OP-15	—	4.5	—	—	4.5	—	—	4.7	—	$\mu s$
		to 0.05% (Note 2)	OP-15	—	1.5	—	—	1.5	—	—	1.6	—	
		to 0.10%	OP-15	—	1.2	—	—	1.2	—	—	1.3	—	
		to 0.01%	OP-16	—	3.8	—	—	3.8	—	—	4.0	—	
		to 0.05% (Note 2)	OP-16	—	1.2	—	—	1.2	—	—	1.3	—	
		to 0.10%	OP-16	—	0.9	—	—	0.9	—	—	1.0	—	
Settling Time	$t_S$	to 0.01%	OP-17	—	1.5	—	—	1.5	—	—	1.6	—	$\mu s$
		to 0.05% (Note 4)	OP-17	—	0.7	—	—	0.7	—	—	0.8	—	
		to 0.10%	OP-17	—	0.6	—	—	0.6	—	—	0.7	—	
Input Voltage Range	IVR		$\pm 10.5$	—	—	$\pm 10.5$	—	—	$\pm 10.3$	—	—	V	
Common-Mode Rejection Ratio	CMRR	$V_{CM} = \pm 10.5V$		86	100	—	86	100	—	—	—	—	dB
		$V_{CM} = \pm 10.3V$		—	—	—	—	—	—	82	96	—	
Power Supply Rejection Ratio	PSRR	$V_S = \pm 10V$ to $\pm 18V$ $V_S = \pm 10V$ to $\pm 15V$		—	10	51	—	10	51	—	—	—	$\mu V/V$
Input Noise Voltage Density	$e_n$	$f_O = 100Hz$		—	20	—	—	20	—	—	20	—	$nV/\sqrt{Hz}$
		$f_O = 1000Hz$		—	15	—	—	15	—	—	15	—	
Input Noise Current Density	$i_n$	$f_O = 100Hz$		—	0.01	—	—	0.01	—	—	0.01	—	$pA/\sqrt{Hz}$
		$f_O = 1000Hz$		—	0.01	—	—	0.01	—	—	0.01	—	
Input Capacitance	$C_{IN}$		—	3	—	—	3	—	—	3	—	pF	

**NOTES:**

- Input bias current is specified for two different conditions. The  $T_J = 25^\circ C$  specification is with the junction at ambient temperature; the Device Operating specification is with the device operating in a warmed-up condition at  $25^\circ C$  ambient. The warmed-up bias current value is correlated to the junction temperature value via the curves of  $I_B$  vs  $T_J$  and  $I_B$  vs  $T_A$ . PMI has a bias current compensation circuit which gives improved bias current over the standard JFET input op amps.  $I_B$  and  $I_{OS}$  are measured at  $V_{CM} = 0$ .
- Settling time is defined here for a unity gain inverter connection using  $2k\Omega$  resistors. It is the time required for the error voltage (the voltage at the

- inverting input pin on the amplifier) to settle to within a specified percent of its final value from the time a 10V step input is applied to the inverter. See settling time test circuit.
- Sample tested.
- Settling time is defined here for a  $A_V = -5$  connection with  $R_F = 2k\Omega$ . It is the time required for the error voltage (the voltage at the inverting input pin on the amplifier) to settle to within 0.01% of its final value from the time a 2V step input is applied to the inverter. See settling time test circuit.

# OP-15/OP-16/OP-17

**ELECTRICAL CHARACTERISTICS** at  $V_S = \pm 15V$ ,  $-55^\circ C \leq T_A \leq 125^\circ C$ , unless otherwise noted.

PARAMETER	SYMBOL	CONDITIONS	OP-15A OP-16A OP-17A			OP-15B OP-16B OP-17B			OP-16C OP-17C			UNITS
			MIN	TYP	MAX	MIN	TYP	MAX	MIN	TYP	MAX	
Input Offset Voltage	$V_{OS}$	$R_S = 50\Omega$	—	0.4	0.9	—	0.7	2.0	—	0.9	4.5	mV
Average Input												
Offset Voltage Drift		(Note 2)										
Without External Trim	$TCV_{OS}$		—	2	5	—	3	10	—	4	15	$\mu V/^\circ C$
With External Trim	$TCV_{OSn}$	$R_P = 100k\Omega$	—	2	—	—	3	—	—	4	—	
Input Offset Current (Note 1)	$I_{OS}$	$T_j = 125^\circ C$	—	0.6	4.0	—	0.8	6.0	—	1.0	9.0	nA
		$T_A = 125^\circ C$	—	0.8	7.0	—	1.2	11	—	1.5	17	
		Device Operating	—	0.6	4.0	—	0.8	6.0	—	1.0	9.0	
		Device Operating	—	1.0	8.5	—	1.3	14.5	—	1.7	22	
Input Bias Current (Note 1)	$I_B$	$T_j = 125^\circ C$	—	$\pm 1.2$	$\pm 5.0$	—	$\pm 1.5$	$\pm 7.5$	—	$\pm 1.8$	$\pm 10$	nA
		$T_A = 125^\circ C$	—	$\pm 1.7$	$\pm 9.0$	—	$\pm 2.2$	$\pm 14$	—	$\pm 2.7$	$\pm 19$	
		Device Operating	—	$\pm 1.2$	$\pm 5.0$	—	$\pm 1.5$	$\pm 7.5$	—	$\pm 1.8$	$\pm 10$	
		Device Operating	—	$\pm 2.0$	$\pm 11$	—	$\pm 2.5$	$\pm 18$	—	$\pm 3.0$	$\pm 25$	
Input Voltage Range	IVR		$\pm 10.4$	—	—	$\pm 10.4$	—	—	$\pm 10.25$	—	—	V
Common-Mode Rejection Ratio	CMRR	$V_{CM} = \pm 10.4V$	85	97	—	85	97	—	—	—	—	dB
		$V_{CM} = \pm 10.25V$	—	—	—	—	—	—	80	93	—	
Power Supply Rejection Ratio	PSRR	$V_S = \pm 10V$ to $\pm 18V$	—	15	57	—	15	57	—	—	—	$\mu V/V$
		$V_S = \pm 10V$ to $\pm 15V$	—	—	—	—	—	—	—	23	100	
Large-Signal Voltage Gain	$A_{VO}$	$R_L \geq 2k\Omega$ $V_O = \pm 10V$	35	120	—	30	110	—	25	100	—	V/mV
Output Voltage Swing	$V_O$	$R_L \geq 10k\Omega$	$\pm 12$	$\pm 13$	—	$\pm 12$	$\pm 13$	—	$\pm 12$	$\pm 13$	—	V

**NOTES:**

- Input bias current is specified for two different conditions. The  $T_j = 25^\circ C$  specification is with the junction at ambient temperature; the Device Operating specification is with the device operating in a warmed-up condition at  $25^\circ C$  ambient. The warmed-up bias current value is correlated to the junction temperature value via the curves of  $I_B$  vs  $T_j$  and  $I_B$  vs  $T_A$ . PMI has a bias current compensation circuit which gives improved bias current over the standard JFET input op amps.  $I_B$  and  $I_{OS}$  are measured at  $V_{CM} = 0$ .
- Sample tested.

# OP-15/OP-16/OP-17

**ELECTRICAL CHARACTERISTICS** at  $V_S = \pm 15V$ ,  $0^\circ C \leq T_A \leq 70^\circ C$  for E and F,  $-40 \leq T_A \leq +85^\circ C$  for G grade, unless otherwise noted.

PARAMETER	SYMBOL	CONDITIONS	OP-15E OP-16E OP-17E			OP-15F OP-16F OP-17F			OP-15G OP-16G OP-17G			UNITS
			MIN	TYP	MAX	MIN	TYP	MAX	MIN	TYP	MAX	
Input Offset Voltage	$V_{OS}$	$R_S = 50\Omega$	—	0.3	0.75	—	0.55	1.5	—	0.7	3.8	mV
Average Input												
Offset Voltage Drift												(Note 2)
Without External Trim	$TCV_{OS}$		—	2	5	—	3	10	—	4	30	$\mu V/^\circ C$
With External Trim	$TCV_{OSn}$	$R_P = 100k\Omega$	—	2	—	—	3	—	—	4	—	
Input Offset Current (Note 1)	$I_{OS}$	$T_J = 70^\circ C$	—	0.04	0.30	—	0.06	0.45	—	0.08	0.65	nA
		$T_A = 70^\circ C$	—	0.06	0.55	—	0.08	0.80	—	0.10	1.2	
		Device Operating	—	0.04	0.30	—	0.06	0.45	—	0.08	0.65	
		Device Operating	—	0.07	0.70	—	0.10	1.1	—	0.15	1.7	
Input Bias Current (Note 1)	$I_B$	$T_J = 70^\circ C$	—	$\pm 0.10$	$\pm 0.40$	—	$\pm 0.12$	$\pm 0.60$	—	$\pm 0.14$	$\pm 0.80$	nA
		$T_A = 70^\circ C$	—	$\pm 0.13$	$\pm 0.75$	—	$\pm 0.16$	$\pm 1.1$	—	$\pm 0.19$	$\pm 1.5$	
		Device Operating	—	$\pm 0.10$	$\pm 0.40$	—	$\pm 0.12$	$\pm 0.60$	—	$\pm 0.14$	$\pm 0.80$	
		Device Operating	—	$\pm 0.15$	$\pm 0.90$	—	$\pm 0.20$	$\pm 1.4$	—	$\pm 0.25$	$\pm 2.0$	
Input Voltage Range	IVR		$\pm 10.4$	—	—	$\pm 10.4$	—	—	$\pm 10.25$	—	—	V
Common-Mode Rejection Ratio	CMRR	$V_{CM} = \pm 10.4V$	85	98	—	85	98	—	—	—	—	dB
		$V_{CM} = \pm 10.25V$	—	—	—	—	—	—	80	94	—	
Power Supply Rejection Ratio	PSRR	$V_S = \pm 10V$ to $\pm 18V$	—	13	57	—	13	57	—	—	—	$\mu V/V$
		$V_S = \pm 10V$ to $\pm 15V$	—	—	—	—	—	—	—	20	100	
Large-Signal Voltage Gain	$A_{VO}$	$R_L \geq 2k\Omega$ $V_O = \pm 10V$	65	200	—	50	180	—	35	160	—	V/mV
Output Voltage Swing	$V_O$	$R_L \geq 10k\Omega$	$\pm 12$	$\pm 13$	—	$\pm 12$	$\pm 13$	—	$\pm 12$	$\pm 13$	—	V

**NOTES:**

- Input bias current is specified for two different conditions. The  $T_J = 25^\circ C$  specification is with the junction at ambient temperature; the Device Operating specification is with the device operating in a warmed-up condition at  $25^\circ C$  ambient. The warmed-up bias current value is correlated to the junction temperature value via the curves of  $I_B$  vs  $T_J$  and  $I_B$  vs  $T_A$ . PMI has a bias current compensation circuit which gives improved bias current over the standard JFET input op amps.  $I_B$  and  $I_{OS}$  are measured at  $V_{CM} = 0$ .
- Sample tested.

# OP-15/OP-16/OP-17

## DICE CHARACTERISTICS (125° C TESTED DICE AVAILABLE)

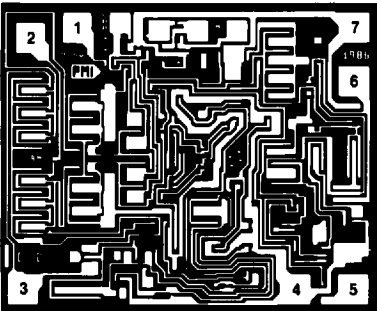

**OP-15**

DIE SIZE 0.068 × 0.056 inch, 3808 sq. mils  
(1.73 × 1.42mm, 2.46 sq. mm)

1. BALANCE
2. INVERTING INPUT
3. NONINVERTING INPUT
4. V-
5. BALANCE
6. OUTPUT
7. V+

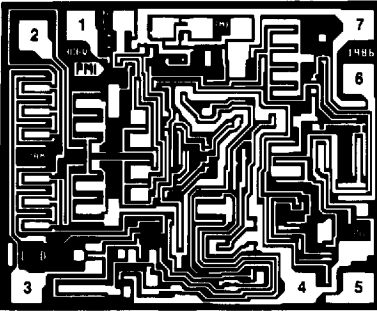

**OP-16**

DIE SIZE 0.068 × 0.056 inch, 3808 sq. mils  
(1.73 × 1.42mm, 2.46 sq. mm)

1. BALANCE
2. INVERTING INPUT
3. NONINVERTING INPUT
4. V-
5. BALANCE
6. OUTPUT
7. V+

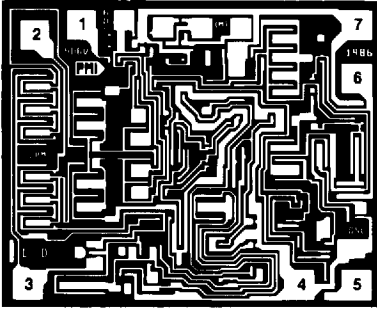

**OP-17**

DIE SIZE 0.068 × 0.056 inch, 3808 sq. mils  
(1.73 × 1.42mm, 2.46 sq. mm)

1. BALANCE
2. INVERTING INPUT
3. NONINVERTING INPUT
4. V-
5. BALANCE
6. OUTPUT
7. V+

**WAFER TEST LIMITS** at  $V_S = \pm 15V$ ,  $T_A = 25^\circ C$  for OP-15/16/17N, OP-15/16/17G and OP-15/16/17GR devices;  $T_A = 125^\circ C$  for OP-15/16/17NT and OP-15/16/17GT devices, unless otherwise noted.

PARAMETER	SYMBOL	CONDITIONS	OP-15NT OP-16NT OP-17NT LIMIT	OP-15N OP-16N OP-17N LIMIT	OP-15GT OP-16GT OP-17GT LIMIT	OP-15G OP-16G OP-17G LIMIT	OP-15GR OP-16GR OP-17GR LIMIT	UNITS
Input Offset Voltage	$V_{OS}$	$R_S = 50\Omega$	0.9	0.5	2.0	1.0	3.0	mV MAX
Large-Signal Voltage Gain	$A_{VO}$	$V_O = \pm 10V$ $R_L = 2k\Omega$	35	100	30	75	50	V/mV MIN
Input Voltage Range	IVR		$\pm 10.4$	$\pm 10.5$	$\pm 10.4$	$\pm 10.5$	$\pm 10.3$	V MIN
Common-Mode Rejection Ratio	CMRR	$V_{CM} = \pm IVR$	85	86	85	86	82	dB MIN
Power Supply Rejection Ratio	PSRR	$V_S = \pm 10V$ to $\pm 20V$ $V_S = \pm 10V$ to $\pm 15V$	57 —	51 —	57 —	51 —	— 80	$\mu V/V$ MAX
Output Voltage Swing	$V_O$	$R_L = 10k\Omega$ $R_L = 2k\Omega$	$\pm 12$ —	$\pm 12$ $\pm 11$	$\pm 12$ —	$\pm 12$ $\pm 11$	$\pm 12$ $\pm 11$	V MIN
Supply Current	$I_{SV}$	OP-15 OP-16, OP-17	— —	4 7	— —	4 7	5 8	mA MAX
Input Bias Current	$I_B$	OP-15 OP-16, OP-17	$\pm 9$ $\pm 11$	— —	$\pm 14$ $\pm 18$	— —	— —	nA MAX
Input Offset Current	$I_{OS}$	OP-15 OP-16, OP-17	7.0 8.5	— —	11.0 14.5	— —	— —	nA MAX

**NOTES:**  
For 25°C characteristics of OP-15/16/17NT and OP-15/16/17GT, see OP-15/16/17N and OP-15/16/17G characteristics, respectively.

Electrical tests are performed at wafer probe to the limits shown. Due to variations in assembly methods and normal yield loss, yield after packaging is not guaranteed for standard product dice. Consult factory to negotiate specifications based on dice lot qualification through sample lot assembly and testing.

# OP-15/OP-16/OP-17

**TYPICAL ELECTRICAL CHARACTERISTICS** at  $V_S = \pm 15V$ ,  $T_A = +25^\circ C$ , unless otherwise noted.

PARAMETER	SYMBOL	CONDITIONS	OP-15NT OP-16NT OP-17NT TYPICAL	OP-15N OP-16N OP-17N TYPICAL	OP-15GT OP-16GT OP-17GT TYPICAL	OP-15G OP-16G OP-17G TYPICAL	OP-15GR OP-16GR OP-17GR TYPICAL	UNITS
Average Input Offset Drift Unnull'd	$TCV_{OS}$		2	2	3	3	4	$\mu V/^\circ C$
Average Input Offset Drift Null'd	$TCV_{OSn}$	$R_P = 100k\Omega$	2	2	3	3	4	$\mu V/^\circ C$
Input Offset Current	$I_{OS}$		3	3	3	3	3	pA
Input Bias Current	$I_B$		$\pm 15$	$\pm 15$	$\pm 15$	$\pm 15$	$\pm 15$	pA
Slew Rate	SR	$A_{VCL} = +1$	OP-15 13	OP-16 13	OP-17 11	OP-15G 11	OP-16G 9	$V/\mu s$
		$A_{VCL} = +5$	OP-15 25	OP-16 25	OP-17 21	OP-15G 21	OP-16G 17	
		to 0.01%	OP-15 4.5	OP-16 4.5	OP-17 4.5	OP-15G 4.5	OP-16G 4.7	
		to 0.05%	OP-15 1.5	OP-16 1.5	OP-17 1.5	OP-15G 1.5	OP-16G 1.6	
Settling Time (see settling time test circuits)	$t_s$	to 0.10%	OP-15 1.2	OP-16 1.2	OP-17 1.2	OP-15G 1.2	OP-16G 1.3	$\mu s$
		to 0.01%	OP-15 3.8	OP-16 3.8	OP-17 3.8	OP-15G 3.8	OP-16G 4.0	
		to 0.05%	OP-15 1.2	OP-16 1.2	OP-17 1.2	OP-15G 1.2	OP-16G 1.3	
		to 0.10%	OP-15 0.9	OP-16 0.9	OP-17 0.9	OP-15G 0.9	OP-16G 1.0	
Gain Bandwidth Product	GBW	to 0.01%	OP-15 1.5	OP-16 1.5	OP-17 1.5	OP-15G 1.5	OP-16G 1.6	MHz
		to 0.05%	OP-15 0.7	OP-16 0.7	OP-17 0.7	OP-15G 0.7	OP-16G 0.8	
		to 0.10%	OP-15 0.6	OP-16 0.6	OP-17 0.6	OP-15G 0.6	OP-16G 0.7	
		OP-15 6.0	OP-16 8.0	OP-17 30	OP-15G 5.7	OP-16G 7.2		
Closed-Loop Bandwidth	CLBW	$A_{VCL} = +1$	OP-15 14	OP-16 14	OP-17 13	OP-15G 13	OP-16G 12	MHz
		$A_{VCL} = +5$	OP-15 19	OP-16 19	OP-17 18	OP-15G 18	OP-16G 17	
		OP-15 11	OP-16 11	OP-17 10	OP-15G 10	OP-16G 9		
Input Noise Voltage Density	$e_n$	$f = 100Hz$	20	20	20	20	20	$nV/\sqrt{Hz}$
		$f = 1000Hz$	15	15	15	15	15	
Input Noise Current Density	$i_n$	$f = 100Hz$	0.01	0.01	0.01	0.01	0.01	$pA/\sqrt{Hz}$
		$f = 1000Hz$	0.01	0.01	0.01	0.01	0.01	
Input Capacitance	$C_{IN}$		3	3	3	3	3	pF

**NOTES:**

For  $25^\circ C$  characteristics of OP-15/16/17NT and OP-15/16/17GT, see OP-15/16/17N and OP-15/16/17G characteristics, respectively.

# OP-15/OP-16/OP-17

## TYPICAL PERFORMANCE CHARACTERISTICS (OP-15/OP-16/OP-17)

### MAXIMUM OUTPUT SWING vs LOAD RESISTANCE

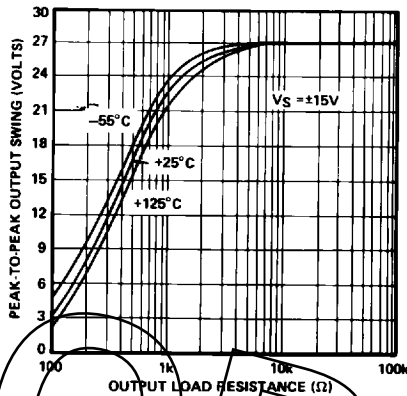

### COMMON-MODE INPUT VOLTAGE RANGE vs SUPPLY VOLTAGE

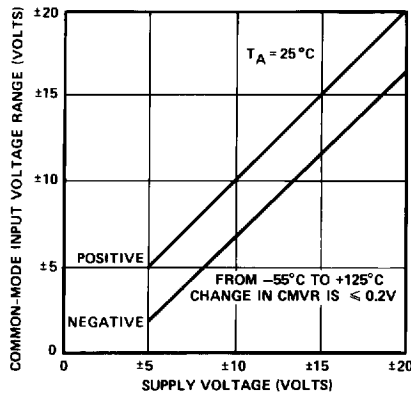

### VOLTAGE NOISE vs SOURCE RESISTANCE

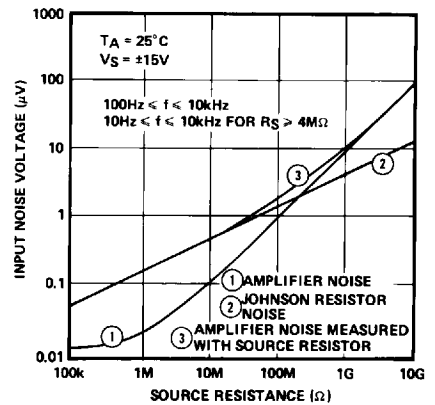

### INPUT BIAS CURRENT vs COMMON-MODE VOLTAGE

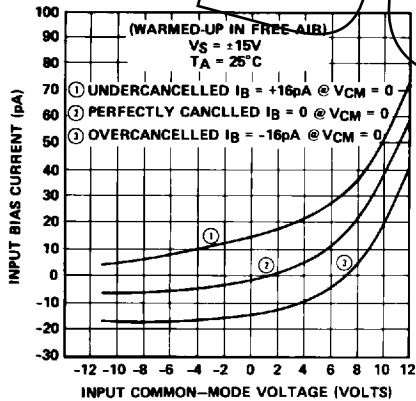

### OPEN-LOOP VOLTAGE GAIN vs SUPPLY VOLTAGE

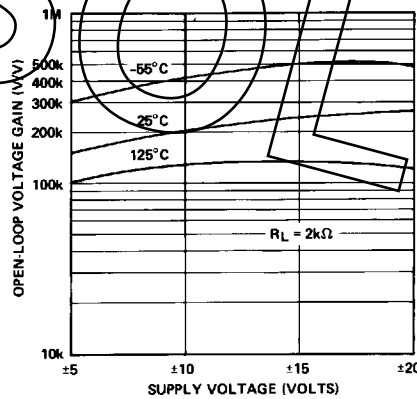

### OUTPUT VOLTAGE SWING vs SUPPLY VOLTAGE

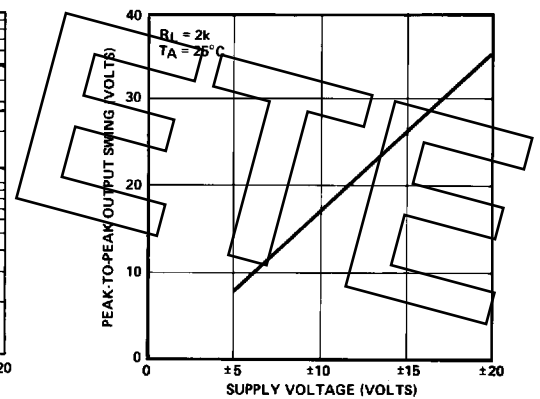

### NULLED OFFSET VOLTAGE DRIFT vs POTENTIOMETER SIZE

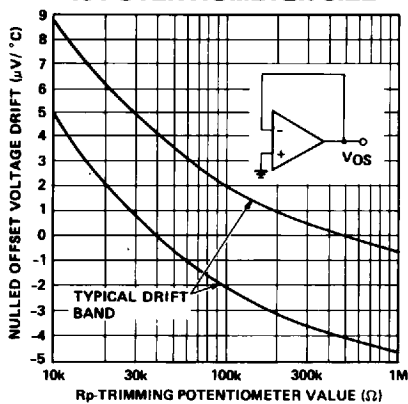

### OFFSET VOLTAGE DRIFT vs TEMPERATURE OF REPRESENTATIVE UNITS

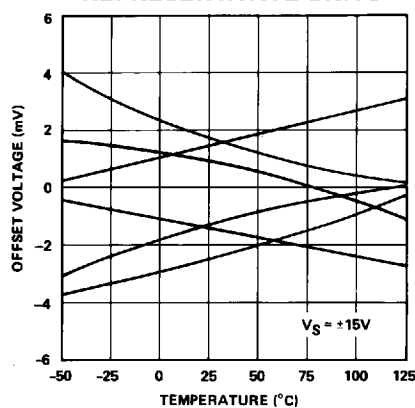

### INPUT BIAS CURRENT vs AMBIENT TEMPERATURE (UNITS ARE WARMED-UP IN FREE AIR)

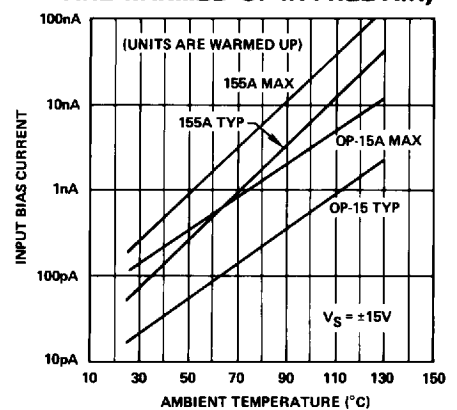



TYPICAL PERFORMANCE CHARACTERISTICS (OP-15/OP-16/OP-17)

BIAS CURRENT vs TIME  
IN FREE AIR  
(OP-15)

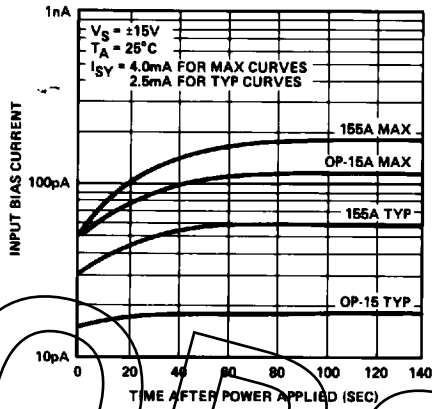

BIAS CURRENT vs TIME  
IN FREE AIR  
(OP-16/OP-17)

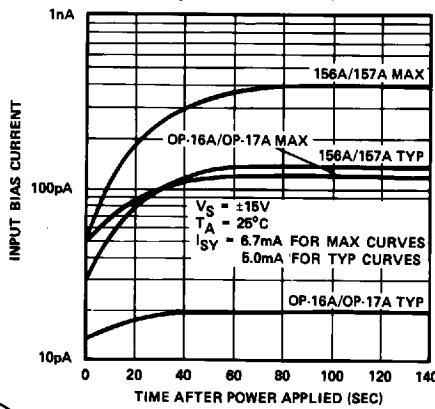

INPUT BIAS CURRENT vs  
AMBIENT TEMPERATURE (UNITS  
ARE WARMED-UP IN FREE AIR)  
(OP-15)

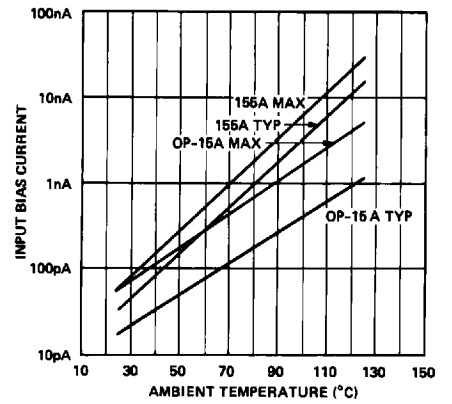

INPUT BIAS CURRENT vs  
AMBIENT TEMPERATURE (UNITS  
ARE WARMED-UP IN FREE AIR)  
(OP-16/OP-17)

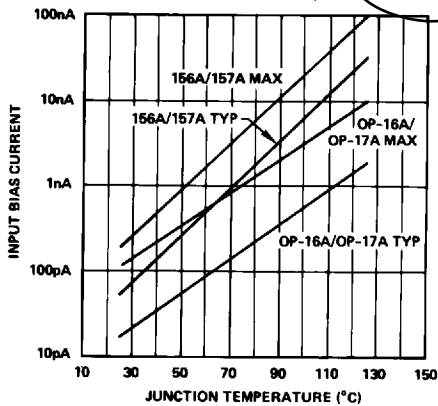

SUPPLY CURRENT  
vs SUPPLY VOLTAGE  
(OP-15)

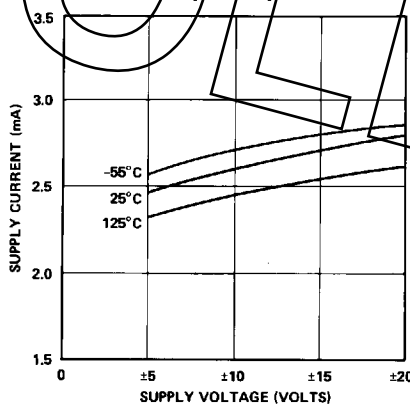

SUPPLY CURRENT  
vs SUPPLY VOLTAGE  
(OP-16/OP-17)

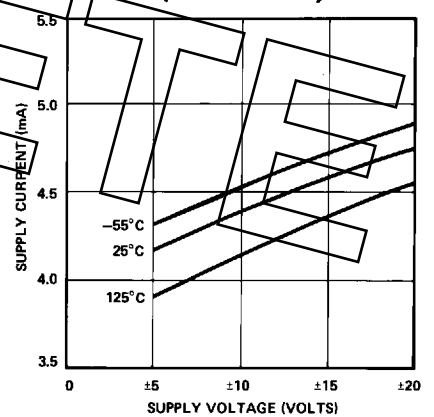

TYPICAL PERFORMANCE CHARACTERISTICS (OP-15)

LARGE-SIGNAL  
TRANSIENT RESPONSE

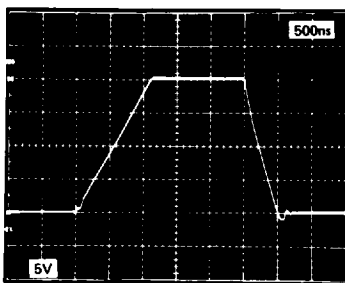

SMALL-SIGNAL  
TRANSIENT RESPONSE

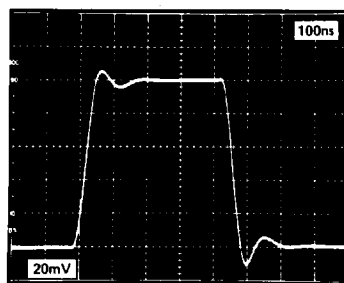

SETTLING TIME

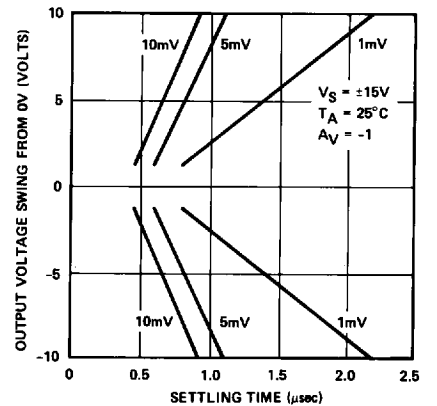

# OP-15/OP-16/OP-17

## TYPICAL PERFORMANCE CHARACTERISTICS (OP-15)

**CLOSED-LOOP BANDWIDTH AND PHASE SHIFT vs FREQUENCY**

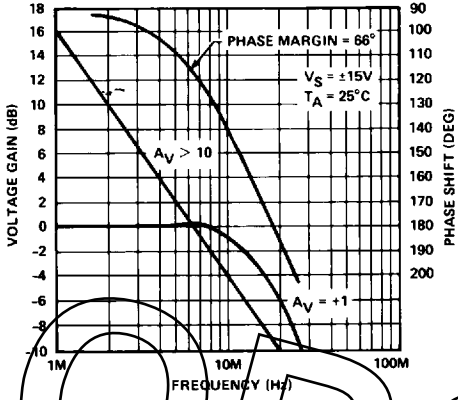

**BANDWIDTH vs TEMPERATURE**

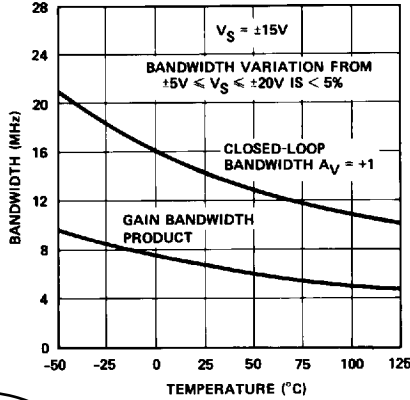

**OPEN-LOOP GAIN vs FREQUENCY**

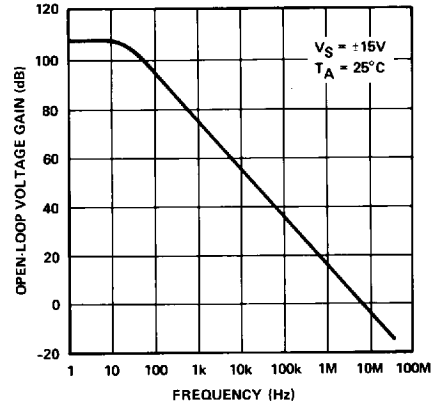

**MAXIMUM OUTPUT SWING vs FREQUENCY**

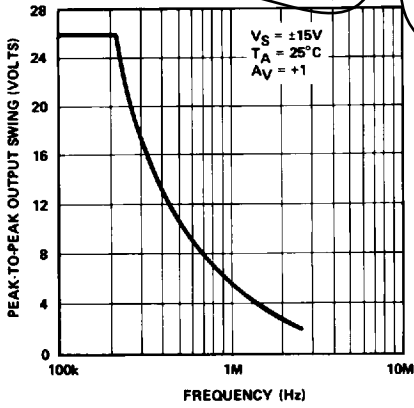

**SLEW RATE vs TEMPERATURE**

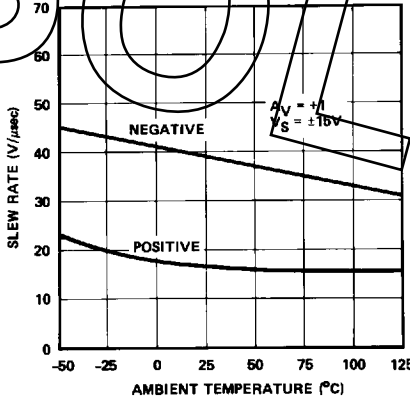

**COMMON-MODE REJECTION RATIO vs FREQUENCY**

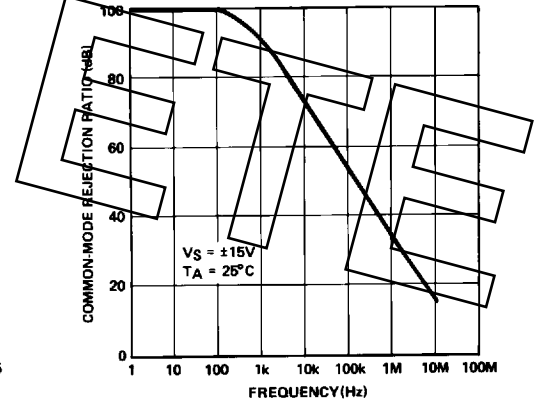

**POWER-SUPPLY REJECTION RATIO vs FREQUENCY**

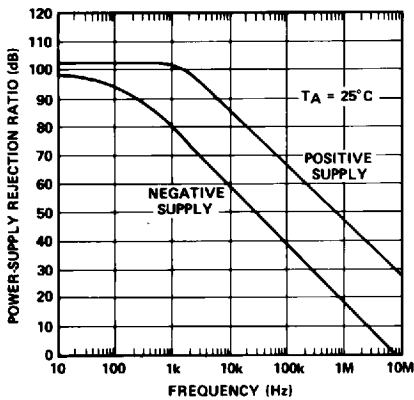

**OUTPUT IMPEDANCE vs FREQUENCY**

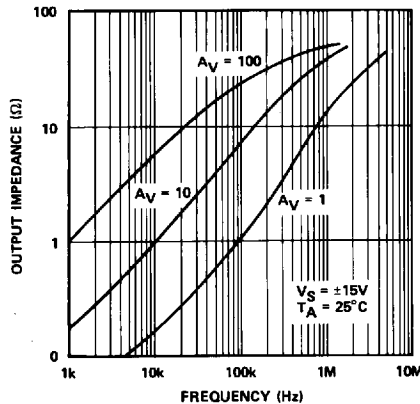

**VOLTAGE NOISE DENSITY vs FREQUENCY**

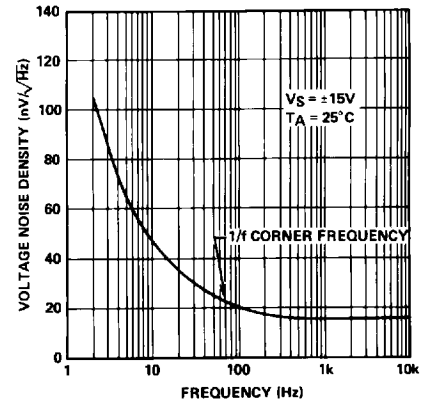

TYPICAL PERFORMANCE CHARACTERISTICS (OP-16)

LARGE-SIGNAL TRANSIENT RESPONSE

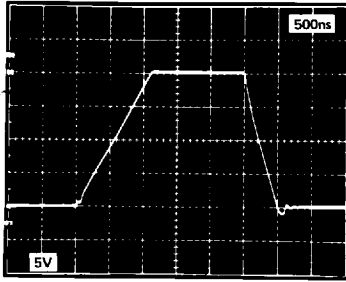

SMALL-SIGNAL TRANSIENT RESPONSE

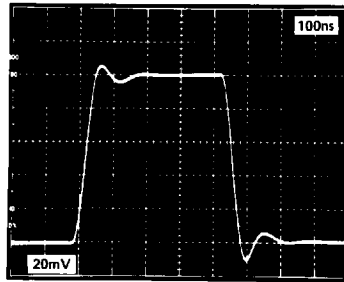

SETTLING TIME

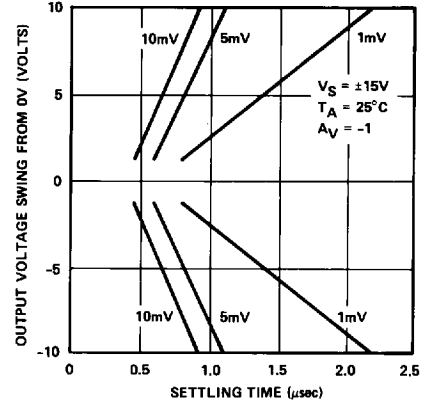

CLOSED-LOOP BANDWIDTH AND PHASE SHIFT vs FREQUENCY

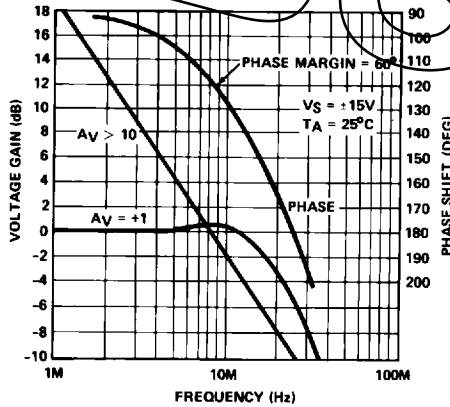

BANDWIDTH vs TEMPERATURE

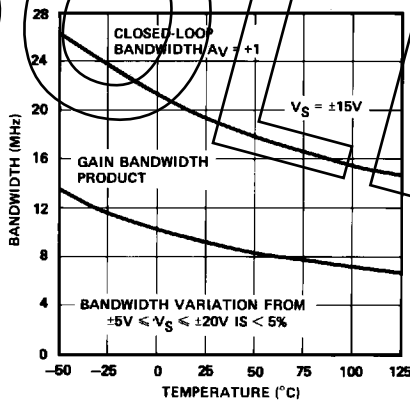

OPEN-LOOP GAIN vs FREQUENCY

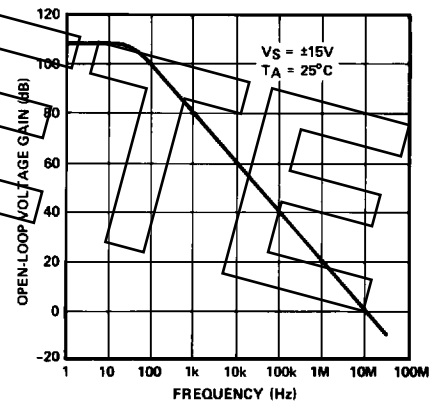

MAXIMUM OUTPUT SWING vs FREQUENCY

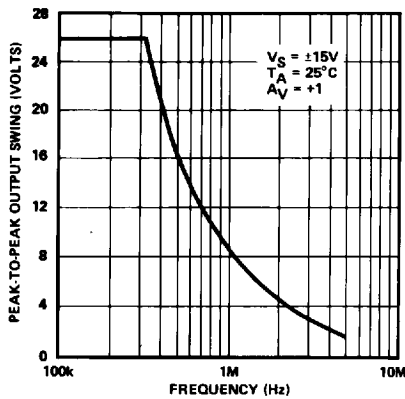

SLEW RATE vs TEMPERATURE

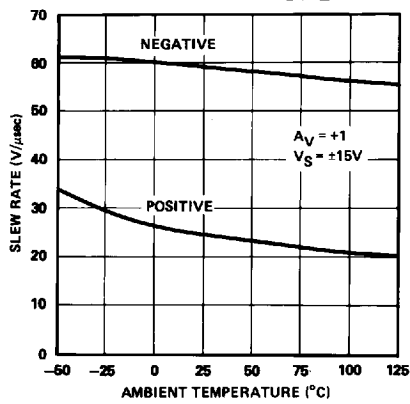

COMMON-MODE REJECTION RATIO vs FREQUENCY

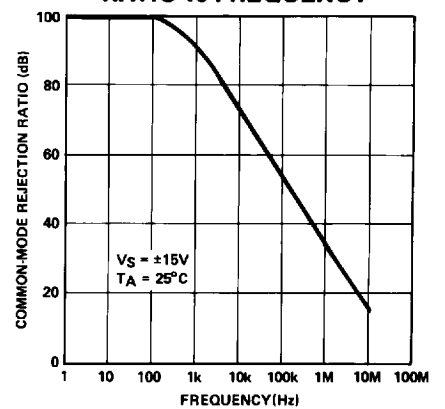

# OP-15/OP-16/OP-17

## TYPICAL PERFORMANCE CHARACTERISTICS (OP-16)

**POWER-SUPPLY REJECTION RATIO vs FREQUENCY**

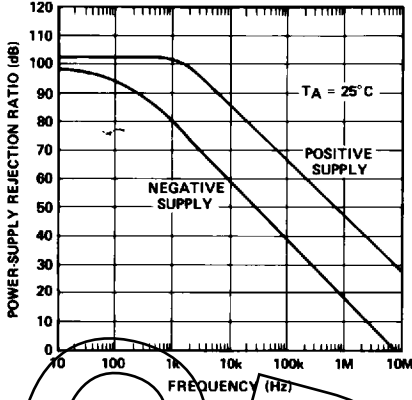

**OUTPUT IMPEDANCE vs FREQUENCY**

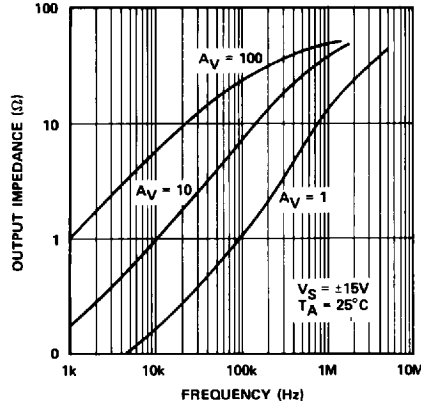

**VOLTAGE NOISE DENSITY vs FREQUENCY**

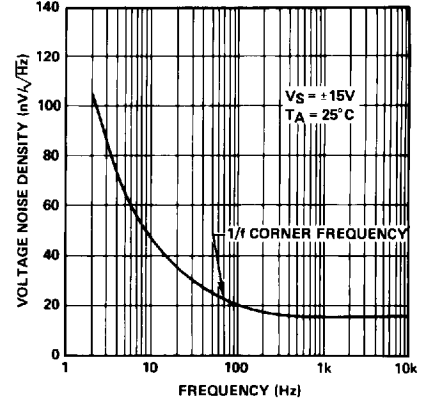

## TYPICAL PERFORMANCE CHARACTERISTICS (OP-17)

**LARGE-SIGNAL TRANSIENT RESPONSE**

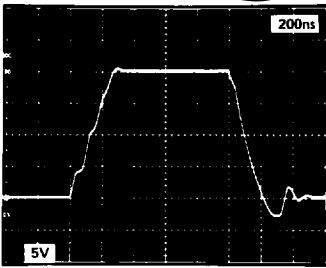

**SMALL-SIGNAL TRANSIENT RESPONSE**

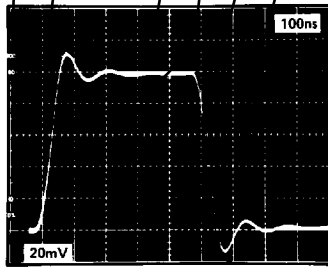

**SETTLING TIME**

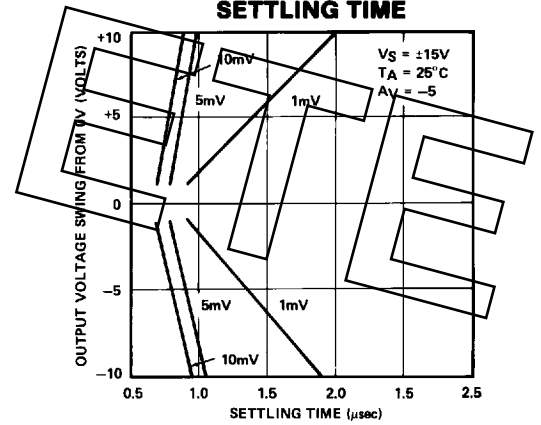

**CLOSED-LOOP BANDWIDTH AND PHASE SHIFT vs FREQUENCY**

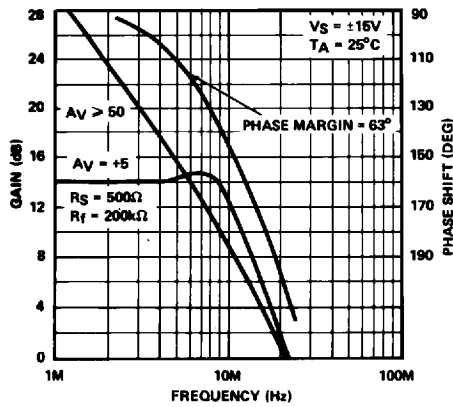

**BANDWIDTH vs TEMPERATURE**

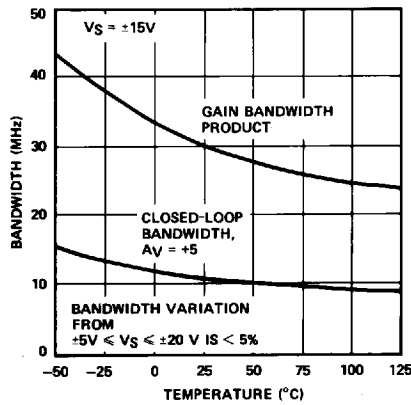

**OPEN-LOOP FREQUENCY RESPONSE**

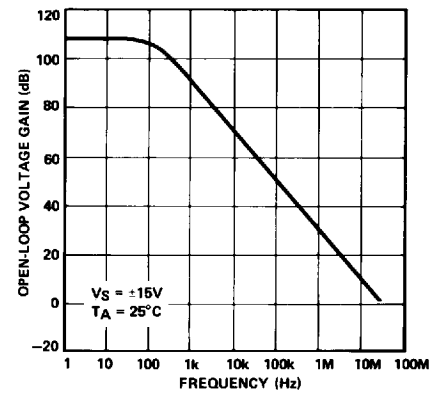

TYPICAL PERFORMANCE CHARACTERISTICS (OP-17)

MAXIMUM OUTPUT SWING vs FREQUENCY

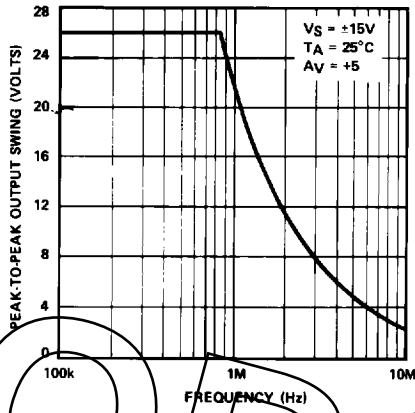

SLEW RATE vs TEMPERATURE

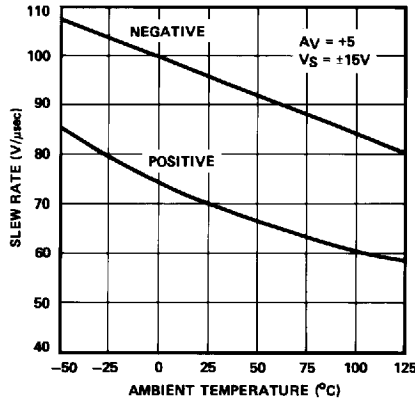

COMMON-MODE REJECTION RATIO vs FREQUENCY

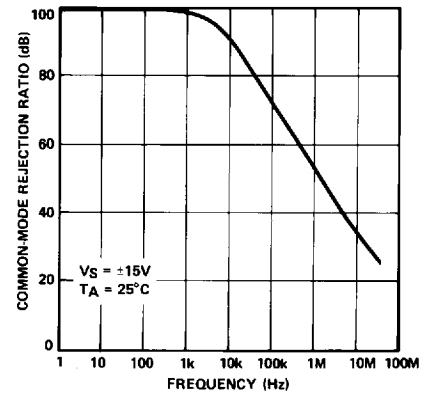

POWER-SUPPLY REJECTION RATIO vs FREQUENCY

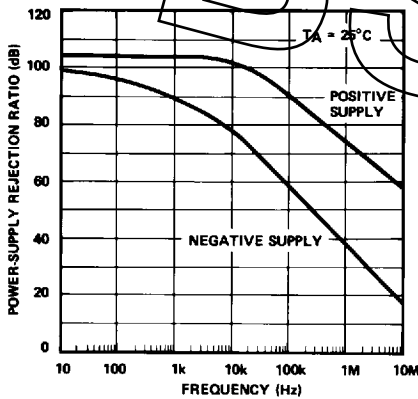

OUTPUT IMPEDANCE vs FREQUENCY

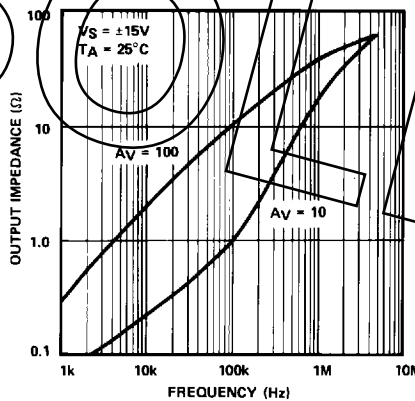

VOLTAGE NOISE vs FREQUENCY

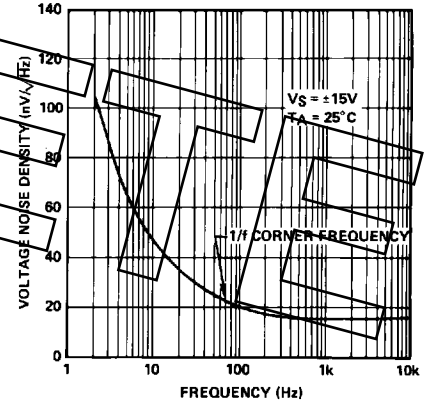

BASIC CONNECTIONS

INPUT OFFSET VOLTAGE NULLING

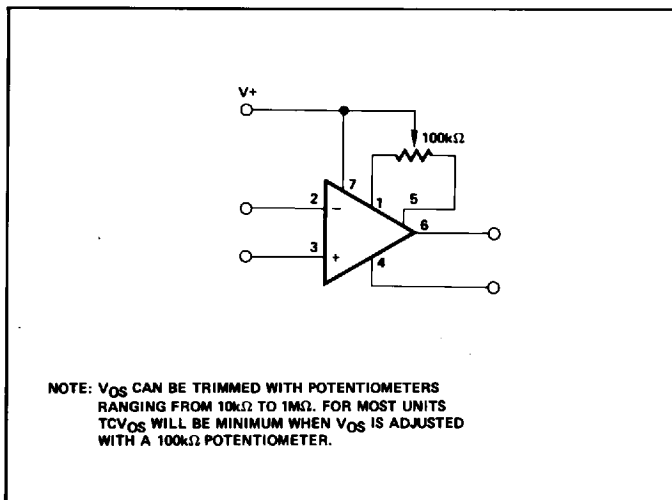

SETTLING-TIME TEST CIRCUIT — OP-15/OP-16

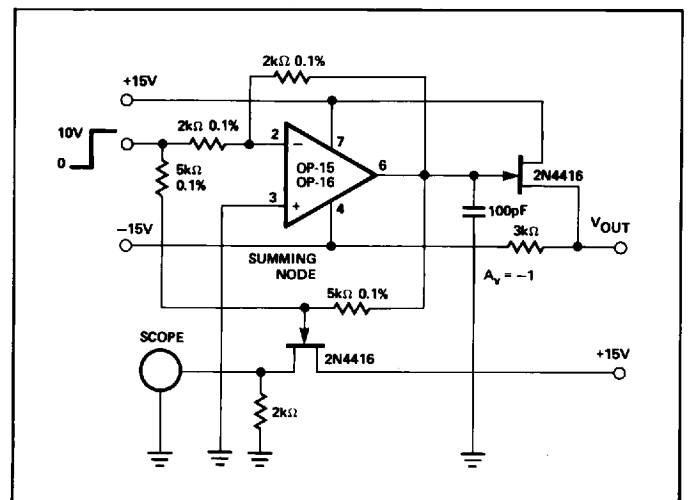

# OP-15/OP-16/OP-17

## SETTLING-TIME TEST CIRCUIT — OP-17

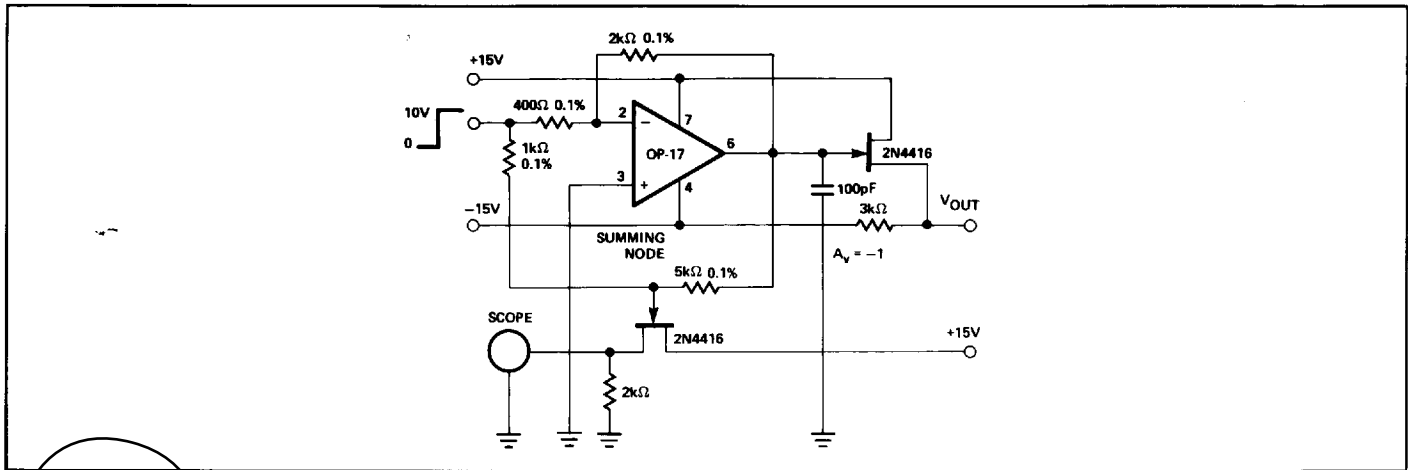

## TYPICAL APPLICATIONS

### CURRENT-TO-VOLTAGE AMPLIFIER OUTPUT

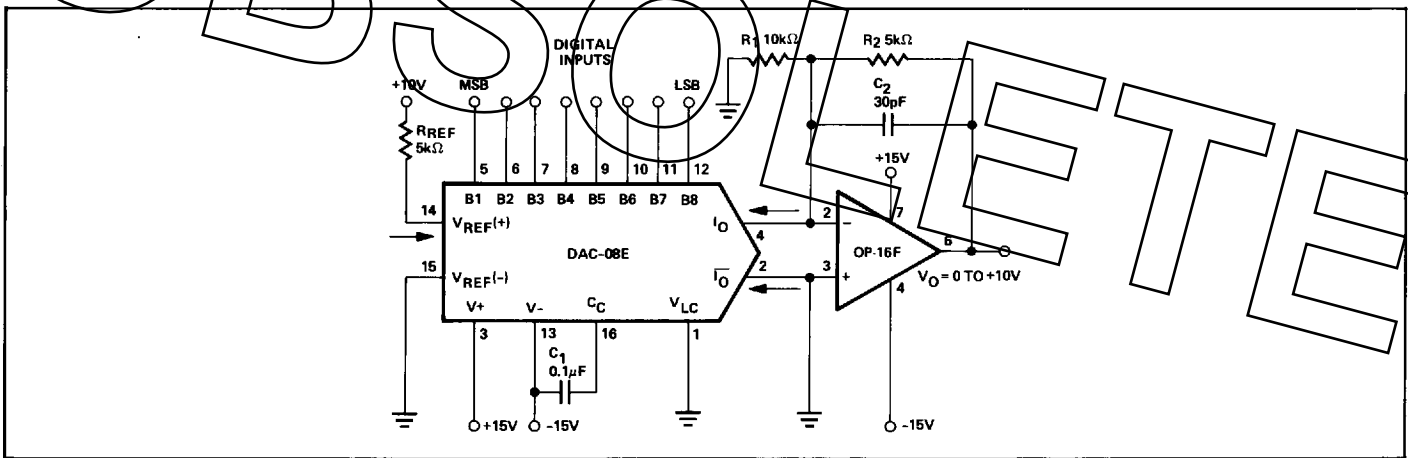

## APPLICATIONS INFORMATION

### DYNAMIC OPERATING CONSIDERATIONS

As with most amplifiers, care should be taken with lead dress, component placement, and supply decoupling in order to ensure stability. For example, resistors from the output to an input should be placed with the body close to the input to minimize "pick-up" and maximize the frequency of the feedback pole by minimizing the capacitance from the input to ground.

A feedback pole is created when the feedback around any amplifier is resistive. The parallel resistance and capacitance

from the input of the device (usually the inverting input) to AC ground set the frequency of the pole. In many instances the frequency of this pole is much greater than the expected 3dB frequency of the closed-loop gain and consequently there is negligible effect on stability margin. However, if the feedback pole is less than approximately six times the expected 3dB frequency, a lead capacitor should be placed from the output to the negative input of the op amp. The value of the added capacitor should be such that the RC time-constant of this capacitor and the resistance it parallels is greater than, or equal to, the original feedback pole time constant.