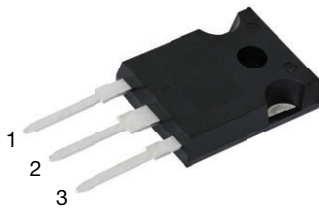
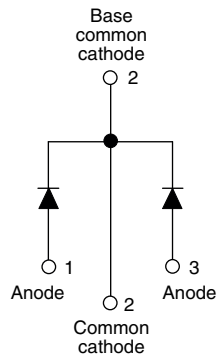

High Performance Schottky Rectifier, 2 x 20 A

TO-247AC 3L

FEATURES

- 150 °C T_J operation
- Very low forward voltage drop
- High frequency operation
- High purity, high temperature epoxy encapsulation for enhanced mechanical strength and moisture resistance
- Guard ring for enhanced ruggedness and long term reliability
- Designed and qualified according to JEDEC®-JESD 47
- Material categorization: for definitions of compliance please see www.vishay.com/doc?99912

RoHS
 COMPLIANT
HALOGEN
FREE

PRIMARY CHARACTERISTICS

$I_{F(AV)}$	2 x 20 A
V_R	60 V
V_F at I_F	0.62 V
I_{RM} typ.	100 mA at 125 °C
T_J max.	150 °C
E_{AS}	13 mJ
Package	TO-247AC 3L
Circuit configuration	Common cathode

DESCRIPTION

The VS-MBR4060WT... center tap Schottky rectifier has been optimized for very low forward voltage drop, with moderate leakage. The proprietary barrier technology allows for reliable operation up to 150 °C junction temperature. Typical applications are in switching power supplies, converters, freewheeling diodes, and reverse battery protection.

MAJOR RATINGS AND CHARACTERISTICS

SYMBOL	CHARACTERISTICS	VALUES	UNITS
$I_{F(AV)}$	Rectangular waveform	40	A
V_{RRM}		60	V
I_{FSM}	$t_p = 5 \mu s$ sine	1020	A
V_F	20 A_{pk} , $T_J = 125$ °C (per leg)	0.62	V
T_J	Range	-55 to +150	°C

VOLTAGE RATINGS

PARAMETER	SYMBOL	VS-MBR4060WT-N3	UNITS
Maximum DC reverse voltage	V_R	60	V
Maximum working peak reverse voltage	V_{RWM}		

ABSOLUTE MAXIMUM RATINGS

PARAMETER	SYMBOL	TEST CONDITIONS	VALUES	UNITS
Maximum average forward current per leg per device	$I_{F(AV)}$	$T_C = 108$ °C, 50 % duty cycle, rectangular waveform	20	A
			40	
Maximum peak one cycle non-repetitive surge current per leg	I_{FSM}	5 μs sine or 3 μs rect. pulse	1020	
		10 ms sine or 6 ms rect. pulse	265	
Non-repetitive avalanche energy per leg	E_{AS}	$T_J = 25$ °C, $I_{AS} = 1.5$ A, $L = 11.5$ mH	13	mJ
Repetitive avalanche current per leg	I_{AR}	Current decaying linearly to zero in 1 μs Frequency limited by T_J maximum $V_A = 1.5 \times V_R$ typical	1.5	A



ELECTRICAL SPECIFICATIONS					
PARAMETER	SYMBOL	TEST CONDITIONS		VALUES	UNITS
Maximum forward voltage drop	$V_{FM}^{(1)}$	20 A	$T_J = 25\text{ }^\circ\text{C}$	0.72	V
			$T_J = 125\text{ }^\circ\text{C}$	0.62	
Maximum instantaneous reverse current	I_{RM}	Rated DC voltage	$T_J = 25\text{ }^\circ\text{C}$	1.0	mA
			$T_J = 125\text{ }^\circ\text{C}$	160	
Typical reverse leakage current per leg	$I_{RM}^{(1)}$	$T_J = 125\text{ }^\circ\text{C}$	$V_R = \text{Rated } V_R$	100	mA
Maximum junction capacitance	C_T	$V_R = 5 V_{DC}$, (test signal range 100 kHz to 1 MHz) $25\text{ }^\circ\text{C}$		720	pF
Typical series inductance	L_S	Measured from top of terminal to mounting plane		7.5	nH
Maximum voltage rate of change	dV/dt	Rated V_R		10 000	V/ μs

Note

(1) Pulse width < 300 μs , duty cycle < 2 %

THERMAL - MECHANICAL SPECIFICATIONS					
PARAMETER	SYMBOL	TEST CONDITIONS		VALUES	UNITS
Maximum junction and storage temperature range	T_J, T_{Stg}			-55 to 150	$^\circ\text{C}$
Maximum thermal resistance, junction to case per package	R_{thJC}	DC operation		2.20	$^\circ\text{C/W}$
Typical thermal resistance, case to heatsink	R_{thCS}	Mounting surface, smooth, and greased		1.10	
Maximum thermal resistance, junction to ambient	R_{thJA}	DC operation		50	
Approximate weight				6	g
				0.21	oz.
Mounting torque	minimum			6 (5)	kgf · cm (lbf · in)
	maximum			12 (10)	
Marking device		Case style TO-247AC 3L		MBR4060WT	

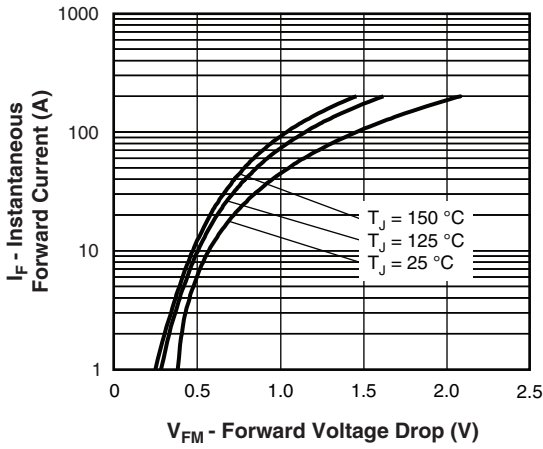

Fig. 1 - Maximum Forward Voltage Drop Characteristics

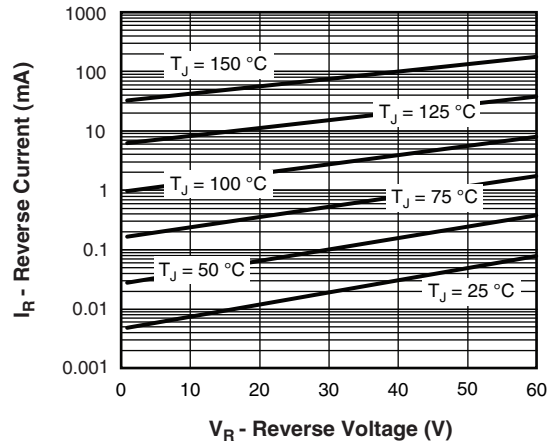

Fig. 2 - Typical Values of Reverse Current vs. Reverse Voltage

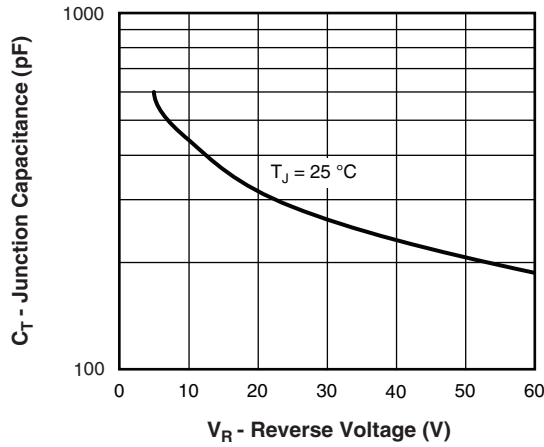

Fig. 3 - Typical Junction Capacitance vs. Reverse Voltage

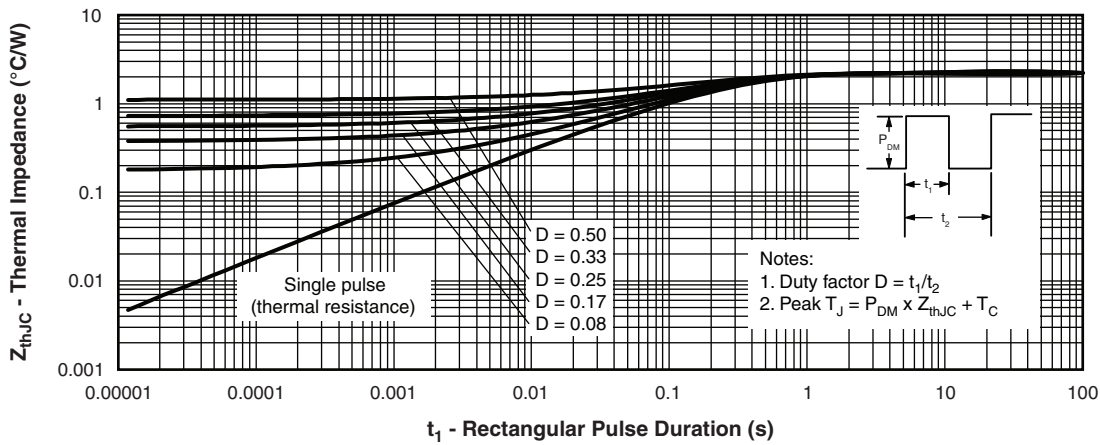

Fig. 4 - Maximum Thermal Impedance Z_{thJC} Characteristics

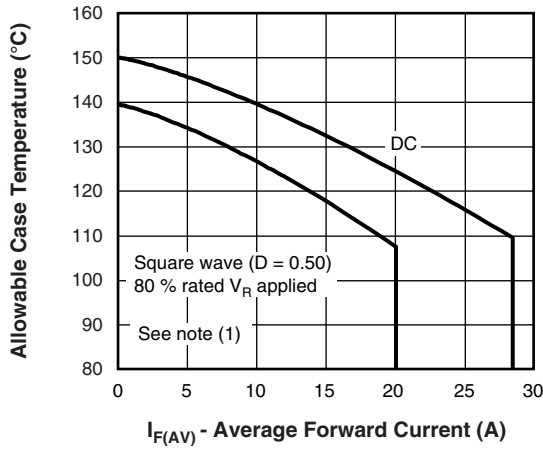

Fig. 5 - Maximum Allowable Case Temperature vs. Average Forward Current

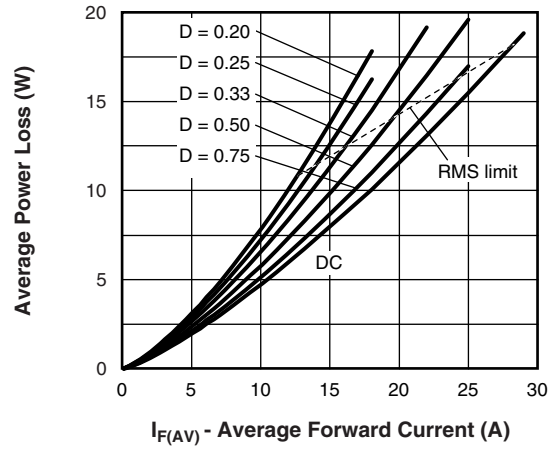

Fig. 6 - Forward Power Loss Characteristics

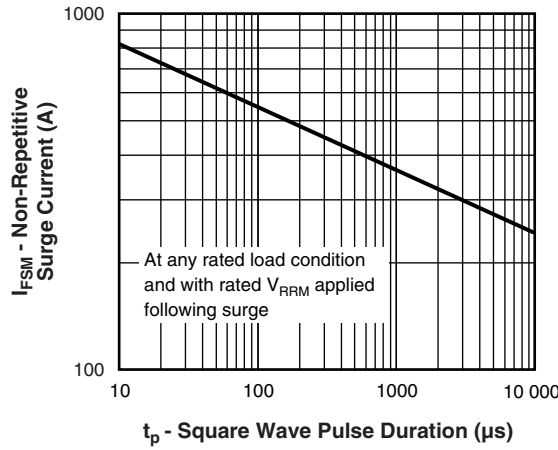

Fig. 7 - Maximum Non-Repetitive Surge Current

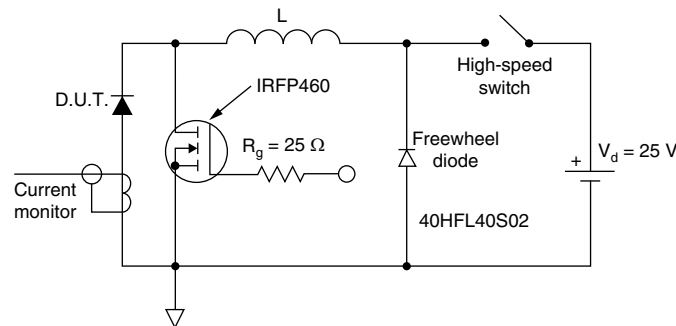

Fig. 8 - Unclamped Inductive Test Circuit

Note

- (1) Formula used: $T_C = T_J - (P_d + P_{dREV}) \times R_{thJC}$;
- P_d = forward power loss = $I_{F(AV)} \times V_{FM}$ at $(I_{F(AV)}/D)$ (see fig. 6);
- P_{dREV} = inverse power loss = $V_{R1} \times I_R (1 - D)$; I_R at $V_{R1} = 80\%$ rated V_R



ORDERING INFORMATION TABLE

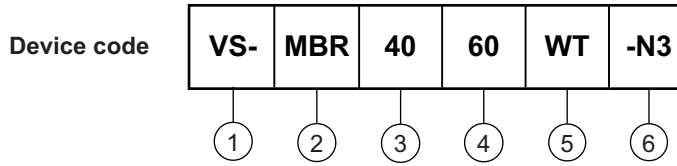

- 1 - Vishay Semiconductors product
- 2 - Schottky MBR series
- 3 - Current rating (40 = 40 A)
- 4 - Voltage rating (60 = 60 V)
- 5 - Circuit configuration:
Center tap (dual) TO-247
- 6 - Environmental digit
-N3 = halogen-free, RoHS-compliant, and totally lead (Pb)-free

ORDERING INFORMATION (Example)			
PREFERRED P/N	QUANTITY PER T/R	MINIMUM ORDER QUANTITY	PACKAGING DESCRIPTION
VS-MBR4060WT-N3	25	500	Antistatic plastic tube

LINKS TO RELATED DOCUMENTS	
Dimensions	www.vishay.com/doc?96138
Part marking information	www.vishay.com/doc?95007



TO-247AC 3L

DIMENSIONS in millimeters and inches



SYMBOL	MILLIMETERS		INCHES		NOTES	SYMBOL	MILLIMETERS		INCHES		NOTES
	MIN.	MAX.	MIN.	MAX.			MIN.	MAX.	MIN.	MAX.	
A	4.65	5.31	0.183	0.209		D2	0.51	1.35	0.020	0.053	
A1	2.21	2.59	0.087	0.102		E	15.29	15.87	0.602	0.625	3
A2	1.17	1.37	0.046	0.054		E1	13.46	-	0.53	-	
b	0.99	1.40	0.039	0.055		e	5.46 BSC		0.215 BSC		
b1	0.99	1.35	0.039	0.053		Ø K	0.254		0.010		
b2	1.65	2.39	0.065	0.094		L	14.20	16.10	0.559	0.634	
b3	1.65	2.34	0.065	0.092		L1	3.71	4.29	0.146	0.169	
b4	2.59	3.43	0.102	0.135		Ø P	3.56	3.66	0.14	0.144	
b5	2.59	3.38	0.102	0.133		Ø P1	-	7.39	-	0.291	
c	0.38	0.89	0.015	0.035		Q	5.31	5.69	0.209	0.224	
c1	0.38	0.84	0.015	0.033		R	4.52	5.49	0.178	0.216	
D	19.71	20.70	0.776	0.815	3	S	5.51 BSC		0.217 BSC		
D1	13.08	-	0.515	-	4						

Notes

- (1) Dimensioning and tolerancing per ASME Y14.5M-1994
- (2) Contour of slot optional
- (3) Dimension D and E do not include mold flash. Mold flash shall not exceed 0.127 mm (0.005") per side. These dimensions are measured at the outermost extremes of the plastic body
- (4) Thermal pad contour optional with dimensions D1 and E1
- (5) Lead finish uncontrolled in L1
- (6) Ø P to have a maximum draft angle of 1.5 to the top of the part with a maximum hole diameter of 3.91 mm (0.154")
- (7) Outline conforms to JEDEC® outline TO-247 with exception of dimension Q



Disclaimer

ALL PRODUCT, PRODUCT SPECIFICATIONS AND DATA ARE SUBJECT TO CHANGE WITHOUT NOTICE TO IMPROVE RELIABILITY, FUNCTION OR DESIGN OR OTHERWISE.

Vishay Intertechnology, Inc., its affiliates, agents, and employees, and all persons acting on its or their behalf (collectively, "Vishay"), disclaim any and all liability for any errors, inaccuracies or incompleteness contained in any datasheet or in any other disclosure relating to any product.

Vishay makes no warranty, representation or guarantee regarding the suitability of the products for any particular purpose or the continuing production of any product. To the maximum extent permitted by applicable law, Vishay disclaims (i) any and all liability arising out of the application or use of any product, (ii) any and all liability, including without limitation special, consequential or incidental damages, and (iii) any and all implied warranties, including warranties of fitness for particular purpose, non-infringement and merchantability.

Statements regarding the suitability of products for certain types of applications are based on Vishay's knowledge of typical requirements that are often placed on Vishay products in generic applications. Such statements are not binding statements about the suitability of products for a particular application. It is the customer's responsibility to validate that a particular product with the properties described in the product specification is suitable for use in a particular application. Parameters provided in datasheets and / or specifications may vary in different applications and performance may vary over time. All operating parameters, including typical parameters, must be validated for each customer application by the customer's technical experts. Product specifications do not expand or otherwise modify Vishay's terms and conditions of purchase, including but not limited to the warranty expressed therein.

Hyperlinks included in this datasheet may direct users to third-party websites. These links are provided as a convenience and for informational purposes only. Inclusion of these hyperlinks does not constitute an endorsement or an approval by Vishay of any of the products, services or opinions of the corporation, organization or individual associated with the third-party website. Vishay disclaims any and all liability and bears no responsibility for the accuracy, legality or content of the third-party website or for that of subsequent links.

Except as expressly indicated in writing, Vishay products are not designed for use in medical, life-saving, or life-sustaining applications or for any other application in which the failure of the Vishay product could result in personal injury or death. Customers using or selling Vishay products not expressly indicated for use in such applications do so at their own risk. Please contact authorized Vishay personnel to obtain written terms and conditions regarding products designed for such applications.

No license, express or implied, by estoppel or otherwise, to any intellectual property rights is granted by this document or by any conduct of Vishay. Product names and markings noted herein may be trademarks of their respective owners.