

MAX2664/MAX2665

VHF/UHF Low-Noise Amplifiers

General Description

The MAX2664 and MAX2665 are ultra-compact LNAs for VHF/UHF applications. These devices incorporate a broadband LNA with an integrated bypass switch. The MAX2664 covers the UHF frequency range from 470MHz to 860MHz, and the MAX2665 covers the VHF frequency range from 75MHz to 230MHz.

Each device has a zero-power bypass mode for improved high-signal-level handling conditions. Additionally, the output port is internally matched to 50Ω while a single external inductor is used to match the input port to 50Ω.

The MAX2664 and MAX2665 are available in a 4-bump (0.8mm x 0.8mm x 0.64mm), lead-free, wafer-level package (WLP).

Applications

- Smartphones/Handsets
- MP3 Players
- Home Audio/Video
- Portable Navigation Devices

Features

- UHF and VHF Frequency Range
 - MAX2664: 470MHz to 860MHz
 - MAX2665: 75MHz to 230MHz
- Low Noise Figure
 - MAX2664: 1.2dB
 - MAX2665: 1.1dB
- High Gain: 15dB
- Zero-Power Bypass Mode
- Single +2.4V to +3.5V Supply Voltage
- Low Current: 3.3mA
- Small Footprint: 0.8mm x 0.8mm
- Thin Profile: 0.64mm

Ordering Information

PART	TEMP RANGE	PIN-PACKAGE
MAX2664EWS+	-40°C to +85°C	4 WLP
MAX2665EWS+	-40°C to +85°C	4 WLP

+Denotes a lead(Pb)-free/RoHS-compliant package.

Functional Diagram

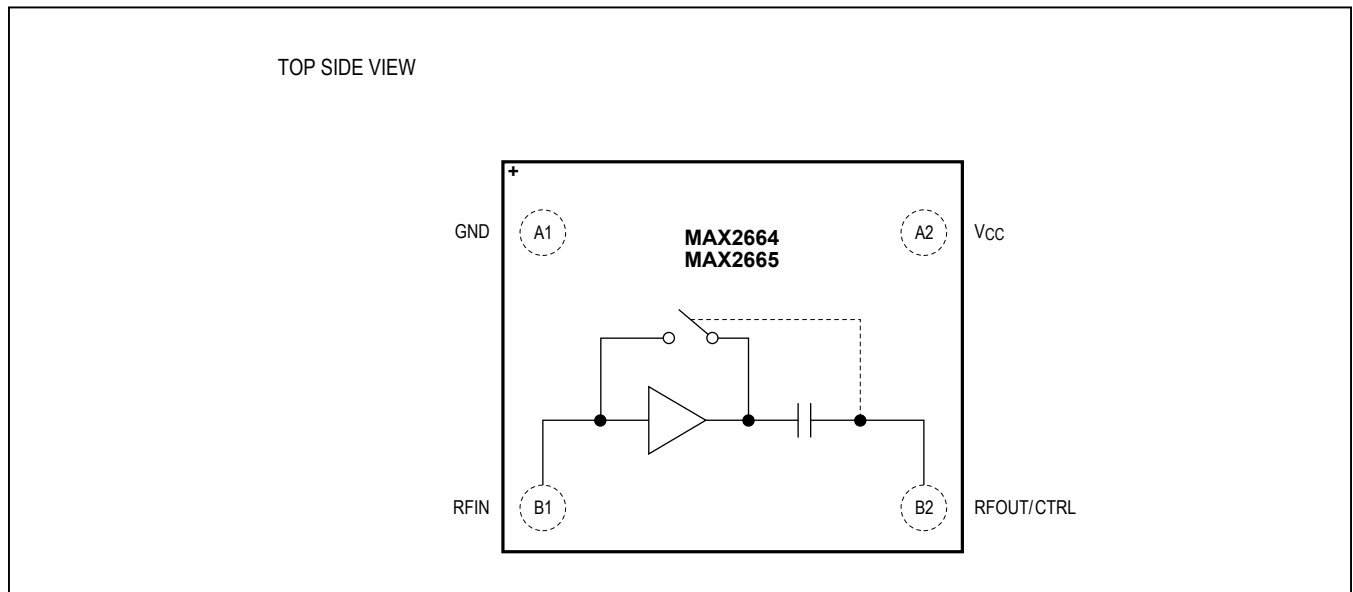

Absolute Maximum Ratings

V_{CC} to GND -0.3V to +3.6V
 Other Pins to GND -0.3V to (Operating V_{CC} + 0.3V)
 Maximum RF Input Power +10dBm
 Short-Circuit Duration: RFIN, RFOUT/CTRL 10s
 Continuous Power Dissipation (T_A = +70°C)
 WLP (derates 9.7mW/°C above +70°C) 776mW

Operating Temperature Range -40°C to +85°C
 Junction Temperature +150°C
 Storage Temperature Range -65°C to +160°C
 Soldering Temperature (reflow) +260°C

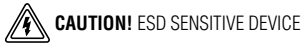

Stresses beyond those listed under "Absolute Maximum Ratings" may cause permanent damage to the device. These are stress ratings only, and functional operation of the device at these or any other conditions beyond those indicated in the operational sections of the specifications is not implied. Exposure to absolute maximum rating conditions for extended periods may affect device reliability.

DC Electrical Characteristics

(MAX2664 and MAX2665 EV kits. V_{CC} = 2.4V to 3.5V, T_A = -40°C to +85°C, no RF signals are applied, RFIN and RFOUT/CTRL are open circuit. Typical values are at V_{CC} = 2.7V and T_A = +25°C, unless otherwise noted.) (Note 1)

PARAMETER	CONDITIONS	MIN	TYP	MAX	UNITS
Supply Voltage		2.4	2.7	3.5	V
Supply Current	Active mode		3.3		mA
	Bypass mode, logic-low = 0V		1		µA
Digital Input Logic-High		0.7 x V _{CC}			V
Digital Input Logic-Low				0.3 x V _{CC}	V
Digital Input Current		-10		+10	µA

AC Electrical Characteristics

(MAX2664 EV kit. V_{CC} = 2.4V to 3.5V, T_A = -40°C to +85°C, UHF f_{RFIN} = 670MHz. Typical values are at V_{CC} = 2.7V and T_A = +25°C, unless otherwise noted.) (Note 1)

PARAMETER	CONDITIONS	MIN	TYP	MAX	UNITS
MAX2664					
Power Gain	Normal mode	11.8	14.8	18	dB
	Bypass mode	-8	-6	-3	
Noise Figure	Normal mode		1.2		dB
	Bypass mode		6		
Third-Order Input Intercept Point (IIP3)	Normal mode (Note 2)		-10		dBm
	Bypass mode (Note 3)		+26		
Input 1dB Compression Point	Normal mode		-5		dBm
	Bypass mode		+7		

AC Electrical Characteristics (continued)

(MAX2664 EV kit. $V_{CC} = 2.4V$ to $3.5V$, $T_A = -40^{\circ}C$ to $+85^{\circ}C$, UHF $f_{RFIN} = 670MHz$. Typical values are at $V_{CC} = 2.7V$ and $T_A = +25^{\circ}C$, unless otherwise noted.) (Note 1)

PARAMETER	CONDITIONS	MIN	TYP	MAX	UNITS
MAX2665					
Power Gain	Normal mode	11.8	15.1	18	dB
	Bypass mode	-8	-5.5	-3	
Noise Figure	Normal mode		1.1		dB
	Bypass mode		5.5		
Third-Order Input Intercept Point (IIP3)	Normal mode (Note 4)		-12		dBm
	Bypass mode (Note 5)		+26		
Input 1dB Compression Point	Normal mode		-11		dBm
	Bypass mode		+6		

Note 1: Min and max limits guaranteed by test at $T_A = +25^{\circ}C$ and guaranteed by design and characterization at $T_A = -40^{\circ}C$ and $T_A = +85^{\circ}C$.

Note 2: Tone-1 = 670MHz (-25dBm), Tone-2 = 676MHz (-25dBm).

Note 3: Tone-1 = 670MHz (0dBm), Tone-2 = 676MHz (0dBm).

Note 4: Tone-1 = 150MHz (-25dBm), Tone-2 = 156MHz (-25dBm).

Note 5: Tone-1 = 150MHz (0dBm), Tone-2 = 156MHz (0dBm).

Typical Operating Characteristics

($T_A = +25^{\circ}C$, unless otherwise noted. MAX2664 and MAX2665 EV kits.)

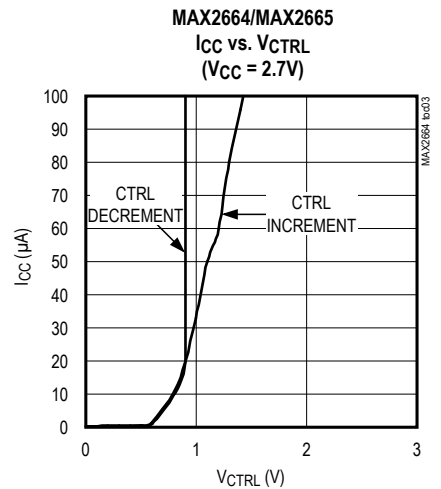
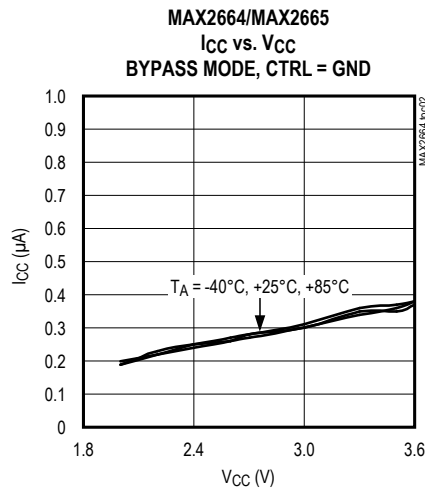
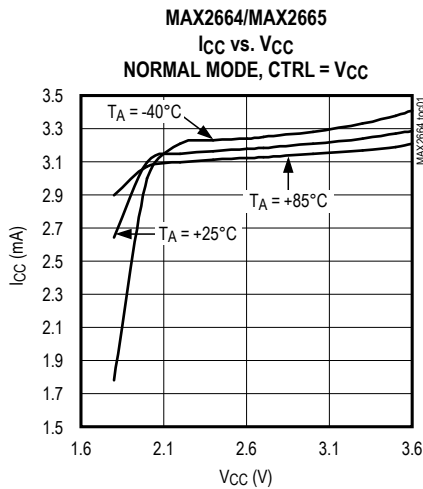

Typical Operating Characteristics (continued)

($T_A = +25^\circ\text{C}$, unless otherwise noted. MAX2664 and MAX2665 EV kits.)

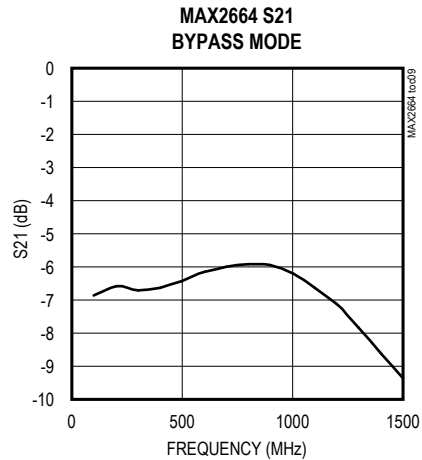
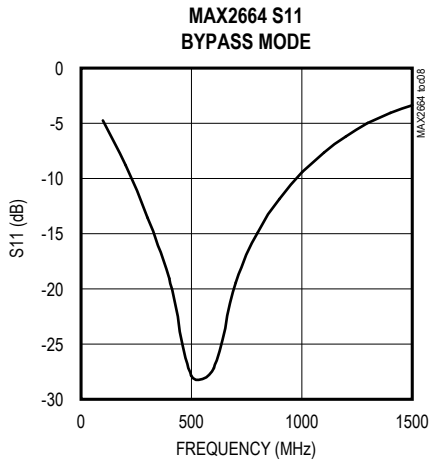
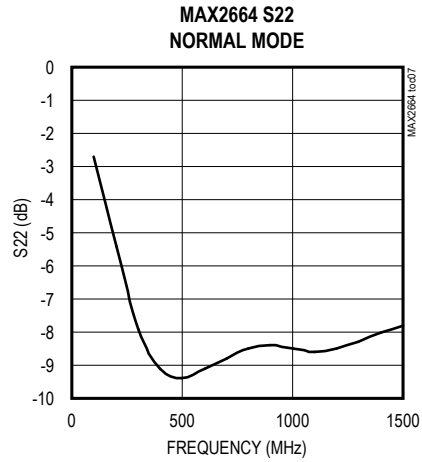
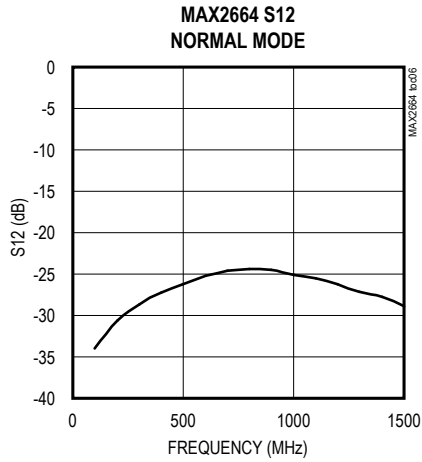
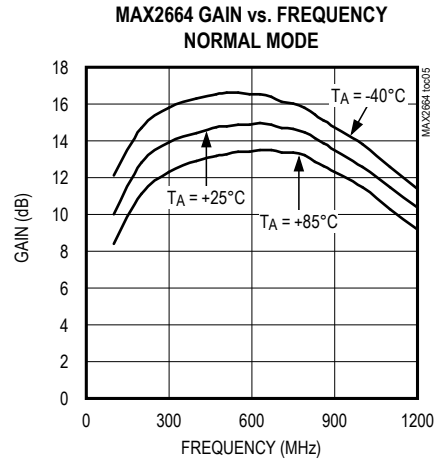
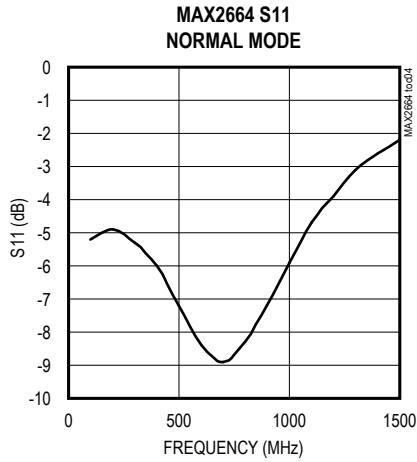

Typical Operating Characteristics (continued)

($T_A = +25^\circ\text{C}$, unless otherwise noted. MAX2664 and MAX2665 EV kits.)

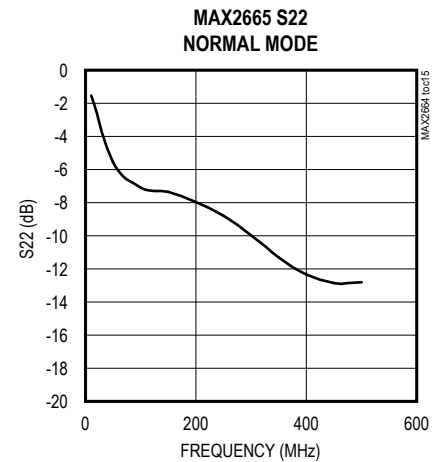
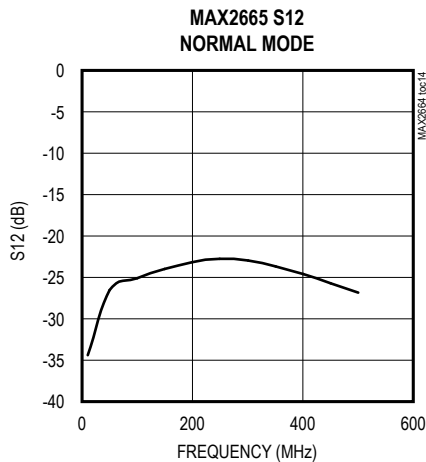
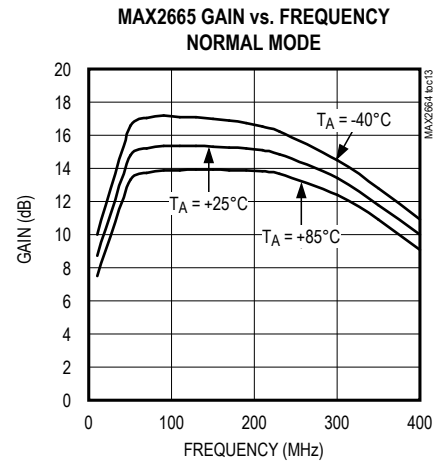
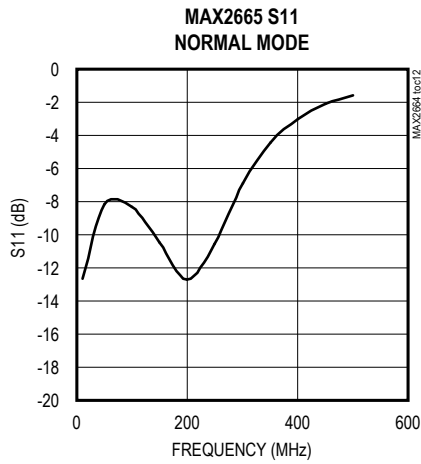
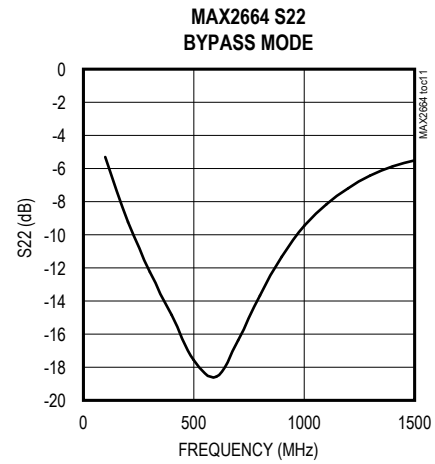
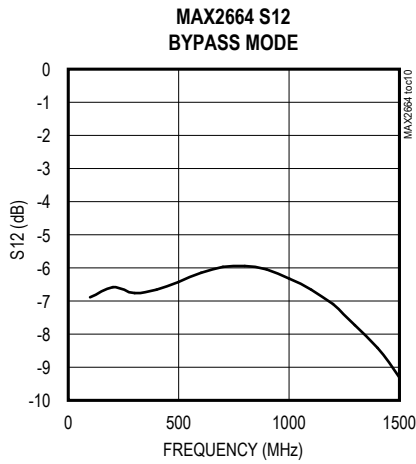

Typical Operating Characteristics (continued)

(T_A = +25°C, unless otherwise noted. MAX2664 and MAX2665 EV kits.)

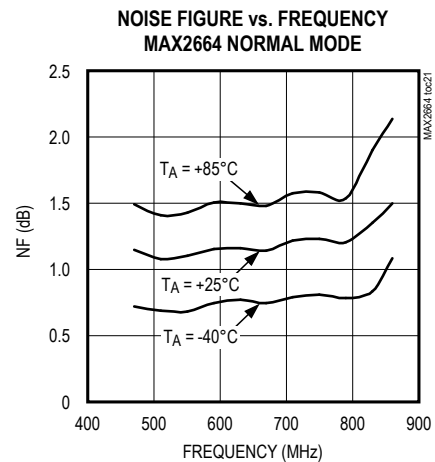
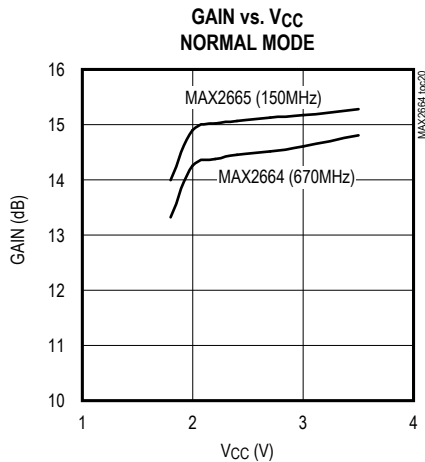
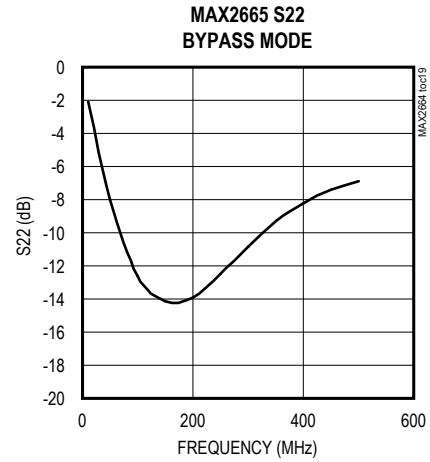
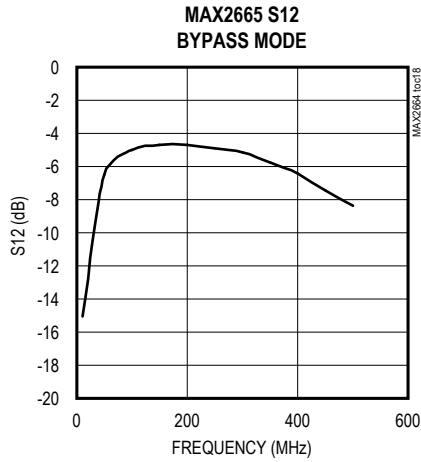
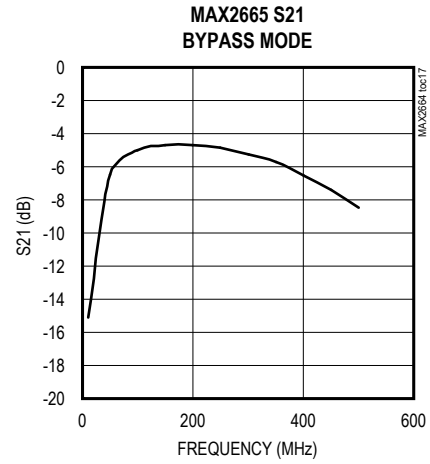
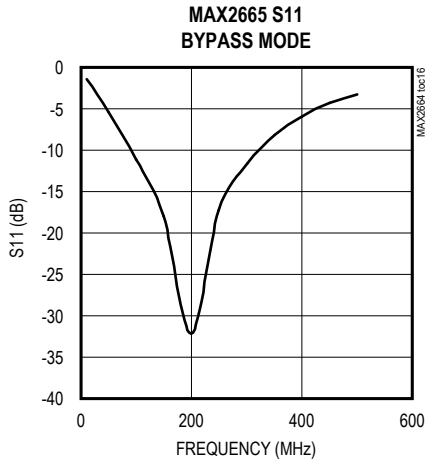

Typical Operating Characteristics (continued)

($T_A = +25^\circ\text{C}$, unless otherwise noted. MAX2664 and MAX2665 EV kits.)

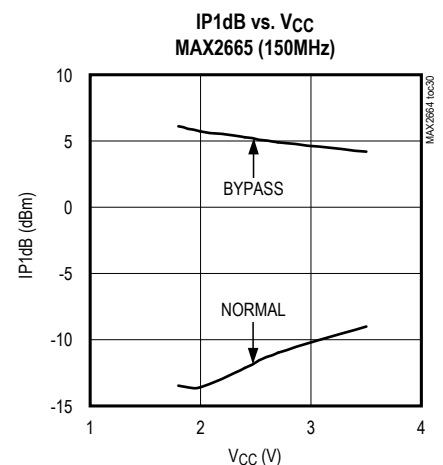
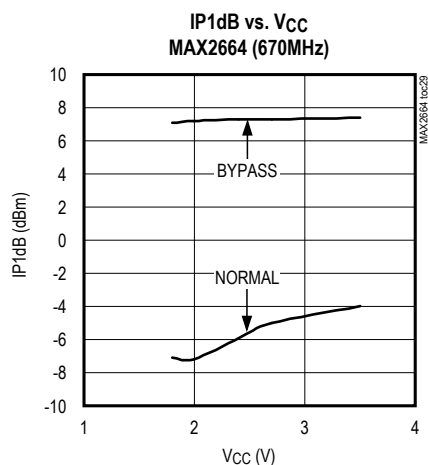
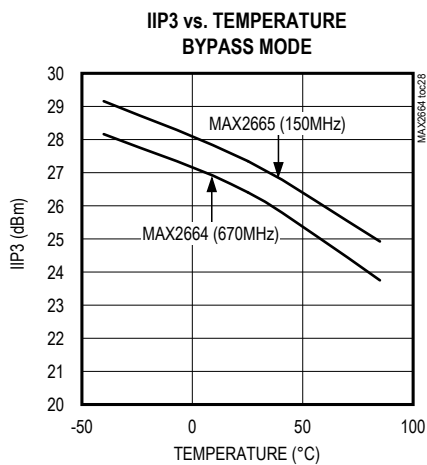
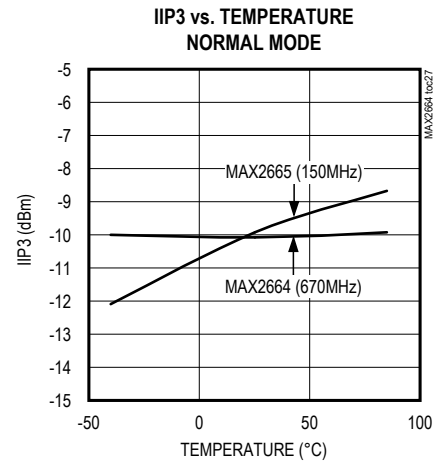
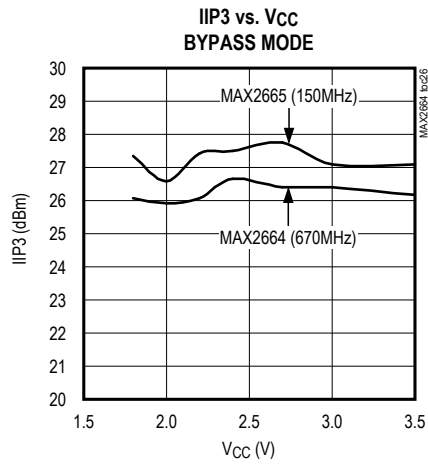
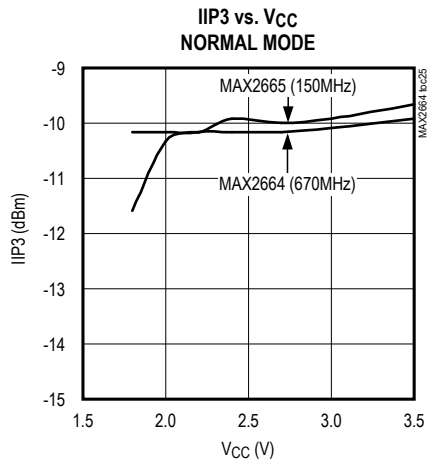
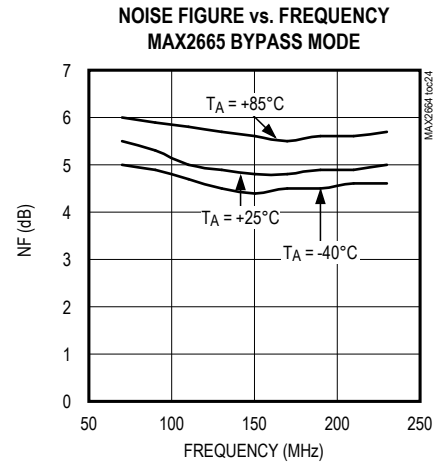
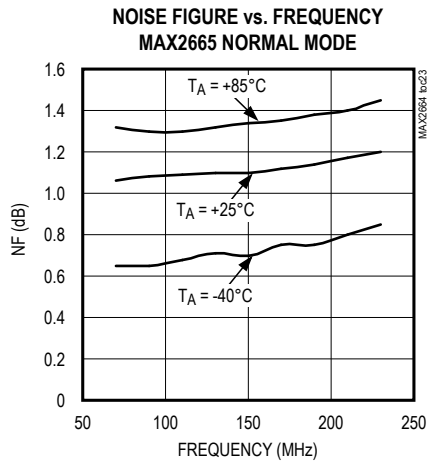
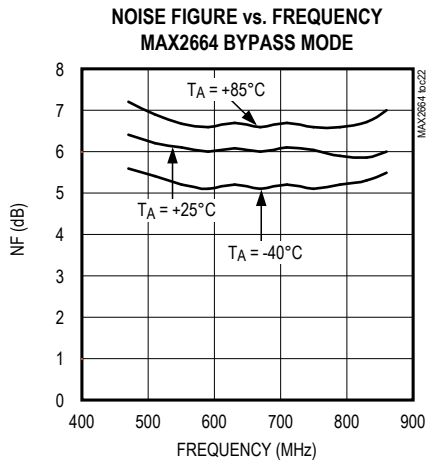

Typical Operating Characteristics (continued)

(T_A = +25°C, unless otherwise noted. MAX2664 and MAX2665 EV kits.)

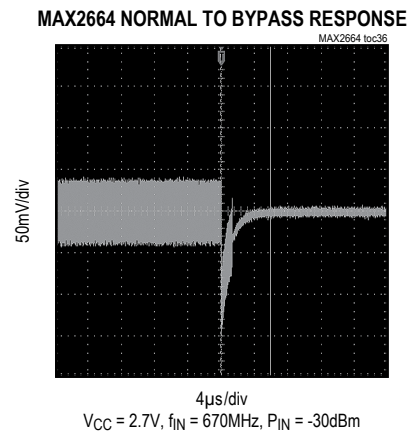
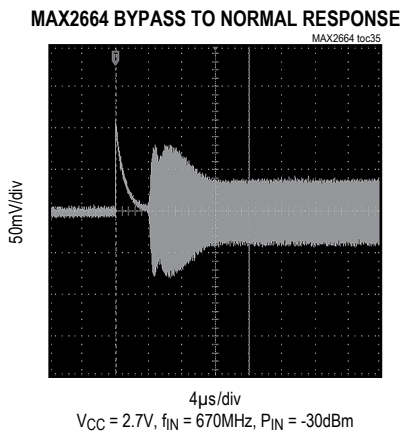
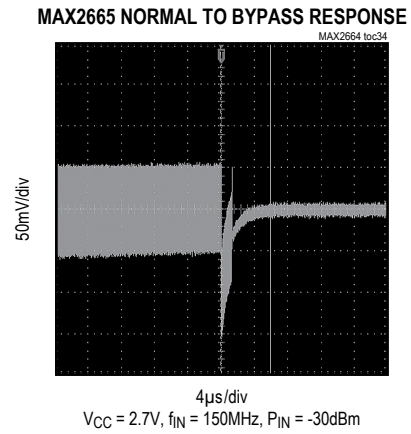
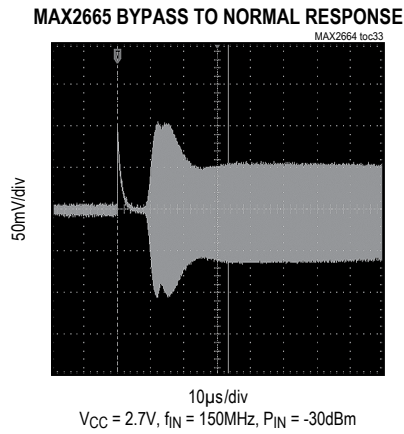
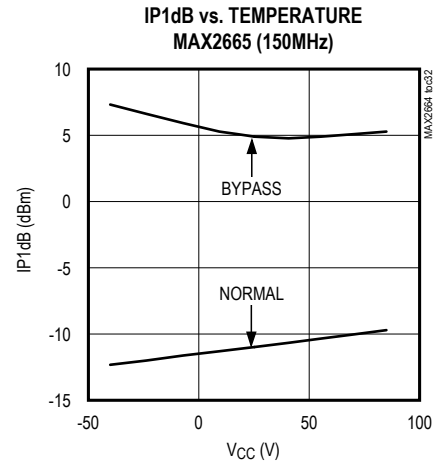
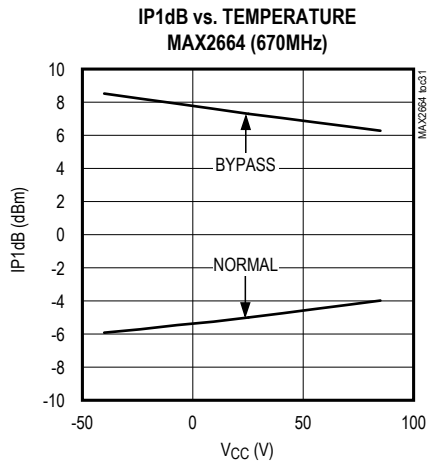

Bump Configuration

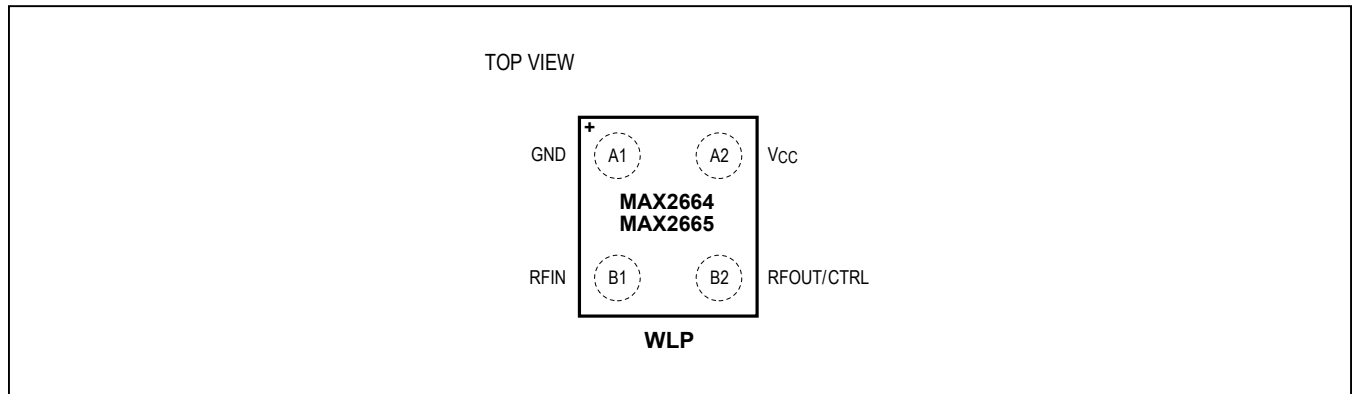

Bump Description

BUMP	NAME	FUNCTION
A1	GND	Ground. Connect to the PCB ground plane with minimal trace inductance.
A2	V _{CC}	Supply Voltage. Bypass to ground with a 1000pF capacitor as close as possible to the IC.
B1	RFIN	RF Input. Requires an external matching inductor and DC-blocking capacitor. The nominal internal DC voltage is 750mV.
B2	RFOUT/CTRL	RF Output and Bypass Control (see the <i>Applications Information</i> section). RFOUT is internally matched to 50Ω and incorporates an internal DC-blocking capacitor.

Detailed Description

The MAX2664/MAX2665 are low-power LNAs designed for VHF/UHF applications. The devices feature an internal LNA bypass control mode for better linearity under high-input-signal power conditions. The devices are offered in a small WLP package.

Input and Output Matching

Only an inductor in series with a DC-blocking capacitor is needed to form the input-matching network. The *Typical Application Circuit* shows the recommended input-matching network. These values are optimized for the best simultaneous gain, noise figure, and return loss performance. Tables 1 and 2 list typical device S-parameter values. The devices integrate an on-chip 50Ω output-matching network, eliminating the need for external matching components.

Table 1. MAX2664 Typical Device S-Parameter at $V_{CC} = 2.7V$, $T_A = +25^\circ C$, $Z_0 = 50\Omega$

FREQUENCY (MHz)	S11	S11 ANGLE	S21	S21 ANGLE	S12	S12 ANGLE	S22	S22 ANGLE
470	0.6664	-55.7	4.945	167.1	0.0449	36.7	0.2847	-65.8
500	0.6675	-58.9	4.964	163.9	0.0462	35.5	0.2795	-64.5
530	0.6674	-62.0	4.979	160.8	0.0474	34.9	0.2769	-63.2
560	0.6674	-65.0	4.978	157.8	0.0484	33.6	0.2787	-62.2
590	0.6673	-67.8	4.972	154.8	0.0500	32.4	0.2819	-61.3
620	0.6667	-70.6	4.958	152.0	0.0507	31.0	0.2858	-60.9
650	0.6651	-73.4	4.938	149.1	0.0523	30.8	0.2937	-60.7
680	0.6662	-75.9	4.916	146.3	0.0528	29.5	0.3011	-60.7
710	0.6651	-78.4	4.885	143.7	0.0539	27.9	0.3098	-61.2
740	0.6639	-80.9	4.852	140.9	0.0550	26.6	0.3185	-61.6
770	0.6624	-83.2	4.810	138.2	0.0560	25.6	0.3276	-62.5
800	0.6610	-85.5	4.764	135.7	0.0570	25.1	0.3372	-63.5
830	0.6598	-87.7	4.714	133.1	0.0573	24.0	0.3478	-64.7
860	0.6600	-89.7	4.667	130.7	0.0579	22.1	0.3571	-66.1

Table 2. MAX2665 Typical Device S-Parameter at $V_{CC} = 2.7V$, $T_A = +25^\circ C$, $Z_0 = 50\Omega$

FREQUENCY (MHz)	S11	S11 ANGLE	S21	S21 ANGLE	S12	S12 ANGLE	S22	S22 ANGLE
60	0.4608	-13.9	5.505	-176.6	0.0519	27.3	0.5060	-32.8
90	0.4944	-29.2	5.564	172.6	0.0546	21.5	0.4518	-33.6
120	0.5160	-42.2	5.507	164.2	0.0571	19.2	0.4270	-35.0
150	0.5368	-53.0	5.366	156.6	0.0593	16.5	0.4181	-38.4
180	0.5601	-62.9	5.173	150.4	0.0612	15.9	0.4036	-41.7
210	0.5800	-71.6	4.979	144.7	0.0630	14.3	0.3948	-45.0
240	0.6006	-79.3	4.783	139.5	0.0649	13.1	0.3870	-48.4

Table 3. MAX2664 Simulated Device Noise Parameters at $V_{CC} = 2.7V$, $T_A = +25^\circ C$, $Z_0 = 50\Omega$

FREQUENCY (MHz)	FMIN (dB)	$ \Gamma_{OPT} $	Γ_{OPT} ANGLE	r_n^*
470	1.014	0.2673	47.4	0.1724
500	1.017	0.2680	50.1	0.1709
530	1.021	0.2691	52.8	0.1695
560	1.024	0.2703	55.4	0.1681
590	1.028	0.2718	58.0	0.1667
620	1.032	0.2735	60.6	0.1653
650	1.036	0.2753	63.1	0.1639
680	1.040	0.2774	65.5	0.1626
710	1.045	0.2796	67.9	0.1612
740	1.049	0.2820	70.3	0.1599
770	1.054	0.2845	72.6	0.1586
800	1.059	0.2871	74.9	0.1573
830	1.064	0.2899	77.1	0.1560
860	1.070	0.2927	79.3	0.1547

* r_n is normalized.

Table 4. MAX2665 Typical Noise Parameters $V_{CC} = 2.7V$, $T_A = +25^\circ C$, $Z_0 = 50\Omega$

FREQUENCY (MHz)	FMIN (dB)	$ \Gamma_{OPT} $	Γ_{OPT} ANGLE	r_n^*
60	0.911	0.1390	34.5	0.1241
90	0.928	0.1458	47.2	0.1240
120	0.940	0.1592	58.1	0.1237
150	0.949	0.1766	67.0	0.1233
180	0.958	0.1962	74.5	0.1227
210	0.967	0.2170	80.7	0.1221
240	0.975	0.2383	86.2	0.1213

* r_n is normalized.

Active Bypass Mode Control

The devices' RFOUT/CTRL pin is used to control the bypass mode of the LNA. When set to logic-high through an external 1k Ω resistor, the devices' active mode is enabled. Conversely, when connected to logic-low, the devices' bypass mode is enabled. An external DC-blocking capacitor should be used to isolate the control function of this dual-purpose pin (see the *Typical Application Circuit*).

Applications Information

A properly designed PCB is essential to any RF microwave circuit. Use controlled-impedance lines on all high-frequency inputs and outputs. Bypass V_{CC} with decoupling capacitors located close to the device. For long V_{CC} lines, it might be necessary to add additional decoupling capacitors. Locate these additional capacitors further away from the device package. Proper grounding of the GND pin is essential. If the PCB uses a topside RF ground, connect it directly to the GND pin. For a board where the ground is not on the component layer, connect the GND pin to the board with multiple vias close to the package.

Refer to www.maximintegrated.com for the MAX2664/MAX2665 S-parameter download, MAX2664/MAX2665 EV kit schematic, gerbers, PADS layout file, and BOM information.

Table 5. Logic Table

RFOUT/CTRL	MODE
High	Active
Low	Bypass

Chip Information

PROCESS: SiGe BiCMOS

Package Information

For the latest package outline information and land patterns (footprints), go to www.maximintegrated.com/packages. Note that a "+", "#", or "." in the package code indicates RoHS status only. Package drawings may show a different suffix character, but the drawing pertains to the package regardless of RoHS status.

PACKAGE TYPE	PACKAGE CODE	OUTLINE NO.	LAND PATTERN NO.
4 WLP	W40A0+1	21-0480	—

Typical Application Circuit

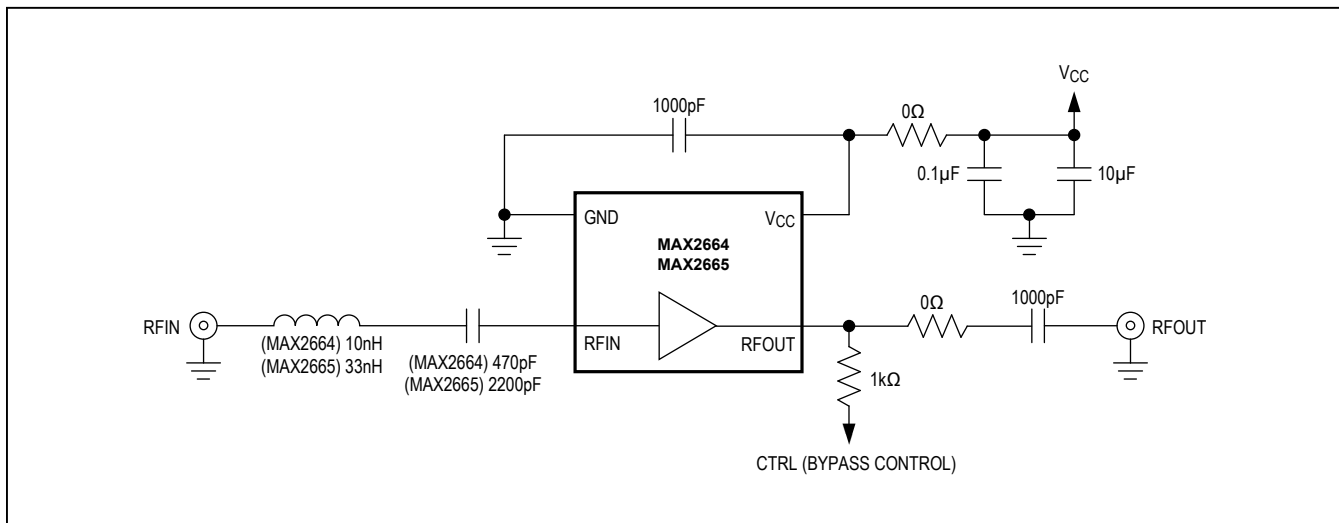

Revision History

REVISION NUMBER	REVISION DATE	DESCRIPTION	PAGES CHANGED
0	8/10	Initial release	—
1	3/15	Removed automotive reference from data sheet	1

For pricing, delivery, and ordering information, please contact Maxim Direct at 1-888-629-4642, or visit Maxim Integrated's website at www.maximintegrated.com.

Maxim Integrated cannot assume responsibility for use of any circuitry other than circuitry entirely embodied in a Maxim Integrated product. No circuit patent licenses are implied. Maxim Integrated reserves the right to change the circuitry and specifications without notice at any time. The parametric values (min and max limits) shown in the Electrical Characteristics table are guaranteed. Other parametric values quoted in this data sheet are provided for guidance.