



Is Now Part of



**ON Semiconductor®**

To learn more about ON Semiconductor, please visit our website at  
[www.onsemi.com](http://www.onsemi.com)

Please note: As part of the Fairchild Semiconductor integration, some of the Fairchild orderable part numbers will need to change in order to meet ON Semiconductor's system requirements. Since the ON Semiconductor product management systems do not have the ability to manage part nomenclature that utilizes an underscore (\_), the underscore (\_) in the Fairchild part numbers will be changed to a dash (-). This document may contain device numbers with an underscore (\_). Please check the ON Semiconductor website to verify the updated device numbers. The most current and up-to-date ordering information can be found at [www.onsemi.com](http://www.onsemi.com). Please email any questions regarding the system integration to [Fairchild\\_questions@onsemi.com](mailto:Fairchild_questions@onsemi.com).

ON Semiconductor and the ON Semiconductor logo are trademarks of Semiconductor Components Industries, LLC dba ON Semiconductor or its subsidiaries in the United States and/or other countries. ON Semiconductor owns the rights to a number of patents, trademarks, copyrights, trade secrets, and other intellectual property. A listing of ON Semiconductor's product/patent coverage may be accessed at [www.onsemi.com/site/pdf/Patent-Marking.pdf](http://www.onsemi.com/site/pdf/Patent-Marking.pdf). ON Semiconductor reserves the right to make changes without further notice to any products herein. ON Semiconductor makes no warranty, representation or guarantee regarding the suitability of its products for any particular purpose, nor does ON Semiconductor assume any liability arising out of the application or use of any product or circuit, and specifically disclaims any and all liability, including without limitation special, consequential or incidental damages. Buyer is responsible for its products and applications using ON Semiconductor products, including compliance with all laws, regulations and safety requirements or standards, regardless of any support or applications information provided by ON Semiconductor. "Typical" parameters which may be provided in ON Semiconductor data sheets and/or specifications can and do vary in different applications and actual performance may vary over time. All operating parameters, including "Typicals" must be validated for each customer application by customer's technical experts. ON Semiconductor does not convey any license under its patent rights nor the rights of others. ON Semiconductor products are not designed, intended, or authorized for use as a critical component in life support systems or any FDA Class 3 medical devices or medical devices with a same or similar classification in a foreign jurisdiction or any devices intended for implantation in the human body. Should Buyer purchase or use ON Semiconductor products for any such unintended or unauthorized application, Buyer shall indemnify and hold ON Semiconductor and its officers, employees, subsidiaries, affiliates, and distributors harmless against all claims, costs, damages, and expenses, and reasonable attorney fees arising out of, directly or indirectly, any claim of personal injury or death associated with such unintended or unauthorized use, even if such claim alleges that ON Semiconductor was negligent regarding the design or manufacture of the part. ON Semiconductor is an Equal Opportunity/Affirmative Action Employer. This literature is subject to all applicable copyright laws and is not for resale in any manner.



# FPF1039 Low On-Resistance, Slew-Rate-Controlled Load Switch

## Features

- 1.2 V to 5.5 V Input Voltage Operating Range
- Typical  $R_{ON}$ :
  - 20 m $\Omega$  at  $V_{IN}=5.5$  V
  - 21 m $\Omega$  at  $V_{IN}=4.5$  V
  - 37 m $\Omega$  at  $V_{IN}=1.8$  V
  - 75 m $\Omega$  at  $V_{IN}=1.2$  V
- Slew Rate / Inrush Control with  $t_R$ : 2.7 ms (Typical)
- 3.5 A Maximum Continuous Current Capability
- Output Capacitor Discharge Function
- Low <1  $\mu$ A Shutdown Current
- ESD Protected: Above 8 kV HBM, 1.5 kV CDM
- GPIO / CMOS-Compatible Enable Circuitry

## Applications

- HDD, Storage, and Solid-State Memory Devices
- Portable Media Devices, UMPC, Tablets, MIDs
- Wireless LAN Cards and Modules
- SLR Digital Cameras
- Portable Medical Devices
- GPS and Navigation Equipment
- Industrial Handheld and Enterprise Equipment

## Description

The FPF1039 advanced load-management switch target applications requiring a highly integrated solution for disconnecting loads powered from DC power rail (<6 V) with stringent shutdown current targets and high load capacitances (up to 200  $\mu$ F). The FPF1039 consists of slew-rate controlled low-impedance MOSFET switch (21 m $\Omega$  typical) and other integrated analog features. The slew-rate controlled turn-on characteristic prevents inrush current and the resulting excessive voltage droop on power rails.

This device has exceptionally low shutdown current drain (<1  $\mu$ A maximum) that facilitates compliance in low standby power applications. The input voltage range operates from 1.2 V to 5.5 V DC to support a wide range of applications in consumer, optical, medical, storage, portable, and industrial device power management.

Switch control is managed by a logic input (active HIGH) capable of interfacing directly with low-voltage control signal / GPIO with no external pull-up required. The device is packaged in advanced fully “green” 1mm x1.5 mm Wafer-Level Chip-Scale Packaging (WLCSP); providing excellent thermal conductivity, small footprint, and low electrical resistance for wider application usage.

## Ordering Information

Part Number	Top Mark	Switch $R_{ON}$ (Typical) at 4.5 $V_{IN}$	Input Buffer	Output Discharge	ON Pin Activity	$t_R$	Package
FPF1039UCX	QF	21 m $\Omega$	CMOS	65 $\Omega$	Active HIGH	2.7 ms	6-Bump, WLCSP, 1.0 mm x 1.5 mm, 0.5 mm Pitch
FPF1039BUCX	QF	21 m $\Omega$	CMOS	65 $\Omega$	Active HIGH	2.7 ms	6-Bump, WLCSP with Backside Laminate, 1.0 mm x 1.5 mm, 0.5 mm Pitch

### Application Diagram

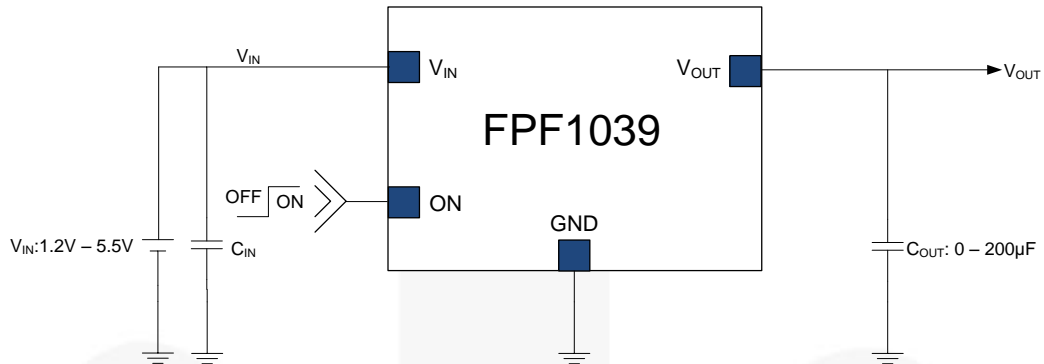


Figure 1. Typical Application

### Functional Block Diagram

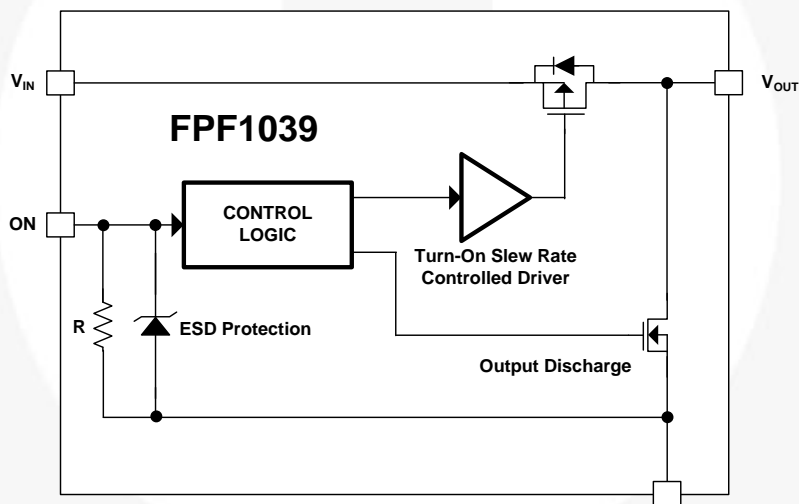


Figure 2. Functional Block Diagram

## Pin Configuration

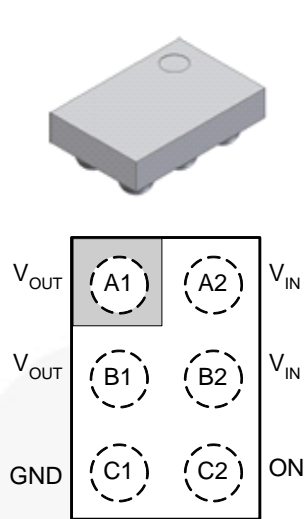


Figure 3. Top View

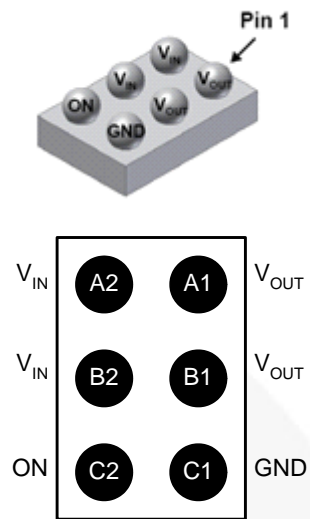


Figure 4. Bottom View

## Pin Definitions

Pin #	Name	Description
A1, B1	$V_{OUT}$	Switch Output
A2, B2	$V_{IN}$	Supply Input: Input to the Power Switch
C1	GND	Ground
C2	ON	ON/OFF Control, Active High - GPIO Compatible

## Absolute Maximum Ratings

Stresses exceeding the absolute maximum ratings may damage the device. The device may not function or be operable above the recommended operating conditions and stressing the parts to these levels is not recommended. In addition, extended exposure to stresses above the recommended operating conditions may affect device reliability. The absolute maximum ratings are stress ratings only.

Symbol	Parameters	Min.	Max.	Unit
$V_{IN}$	$V_{IN}$ , $V_{OUT}$ , $V_{ON}$ to GND	-0.3	6.0	V
$I_{SW}$	Maximum Continuous Switch Current		3.5	A
$P_D$	Power Dissipation at $T_A=25^\circ\text{C}$		1.2	W
$T_{STG}$	Storage Junction Temperature	-65	+150	$^\circ\text{C}$
$T_A$	Operating Temperature Range	-40	+85	$^\circ\text{C}$
$\Theta_{JA}$	Thermal Resistance, Junction-to-Ambient		85 <sup>(1)</sup>	$^\circ\text{C/W}$
			110 <sup>(2)</sup>	
ESD	Electrostatic Discharge Capability	Human Body Model, JESD22-A114		kV
		Charged Device Model, JESD22-C101		

### Notes:

1. Measured using 2S2P JEDEC std. PCB.
2. Measured using 2S2P JEDEC PCB COLD PLATE method.

## Recommended Operating Conditions

The Recommended Operating Conditions table defines the conditions for actual device operation. Recommended operating conditions are specified to ensure optimal performance to the datasheet specifications. Fairchild does not recommend exceeding them or designing to Absolute Maximum Ratings.

Symbol	Parameters	Min.	Max.	Unit
$V_{IN}$	Input Voltage	1.2	5.5	V
$T_A$	Ambient Operating Temperature	-40	+85	$^\circ\text{C}$

## Electrical Characteristics

Unless otherwise noted,  $V_{IN}=1.2$  to  $5.5V$  and  $T_A=-40$  to  $+85^\circ C$ ; typical values are at  $V_{IN}=4.5V$  and  $T_A=25^\circ C$ .

Symbol	Parameters	Conditions	Min.	Typ.	Max.	Units
<b>Basic Operation</b>						
$V_{IN}$	Input Voltage		1.2		5.5	V
$I_{Q(OFF)}$	Off Supply Current	$V_{ON}=GND, V_{OUT}=Open$			1.0	$\mu A$
$I_{SD}$	Shutdown Current	$V_{ON}=GND, V_{OUT}=GND$		0.2	1.0	$\mu A$
$I_Q$	Quiescent Current	$I_{OUT}=0$ mA		5.5	8.0	$\mu A$
$R_{ON}$	On Resistance	$V_{IN}=5.5$ V, $I_{OUT}=1$ A <sup>(3)</sup>		20	24	m $\Omega$
		$V_{IN}=4.5$ V, $I_{OUT}=1$ A, $T_A=25^\circ C$		21	25	
		$V_{IN}=3.3$ V, $I_{OUT}=500$ mA <sup>(3)</sup>		24	29	
		$V_{IN}=2.5$ V, $I_{OUT}=500$ mA <sup>(3)</sup>		28	35	
		$V_{IN}=1.8$ V, $I_{OUT}=250$ mA <sup>(3)</sup>		37	45	
		$V_{IN}=1.2$ V, $I_{OUT}=250$ mA, $T_A=25^\circ C$		75	100	
$R_{PD}$	Output Discharge $R_{PULL\ DOWN}$	$V_{IN}=4.5$ V, $V_{ON}=0$ V, $I_{FORCE}=20$ mA, $T_A=25^\circ C$		65	85	$\Omega$
$V_{IH}$	On Input Logic HIGH Voltage		1.0			V
$V_{IL}$	On Input Logic LOW Voltage				0.4	V
$I_{ON}$	On Input Leakage				1.5	$\mu A$
<b>Dynamic Characteristics</b>						
$t_{DON}$	Turn-On Delay <sup>(4)</sup>	$V_{IN}=4.5$ V, $R_L=5$ $\Omega$ , $C_L=100$ $\mu F$ , $T_A=25^\circ C$		1.7		ms
$t_R$	$V_{OUT}$ Rise Time <sup>(4)</sup>			2.7		ms
$t_{ON}$	Turn-On Time <sup>(6)</sup>			4.4		ms
$t_{DOFF}$	Turn-Off Delay <sup>(4,5)</sup>	$V_{IN}=4.5$ V, $R_L=150$ $\Omega$ , $C_L=100$ $\mu F$ , $T_A=25^\circ C$ <sup>(5)</sup>		0.5		ms
$t_F$	$V_{OUT}$ Fall Time <sup>(4,5)</sup>			10.0		ms
$t_{OFF}$	Turn-Off <sup>(5,7)</sup>			10.5		ms

### Notes:

3. This parameter is guaranteed by design and characterization; not production tested.
4.  $t_{DON}/t_{DOFF}/t_R/t_F$  are defined in Figure 32.
5. Output discharge enabled during off-state.
6.  $t_{ON}=t_R + t_{DON}$
7.  $t_{OFF}=t_F + t_{DOFF}$

## Typical Characteristics

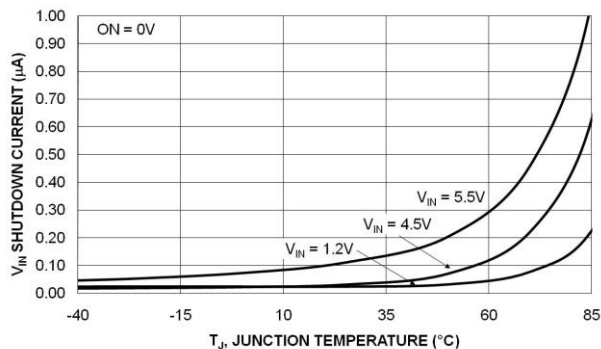


Figure 5. Shutdown Current vs. Temperature

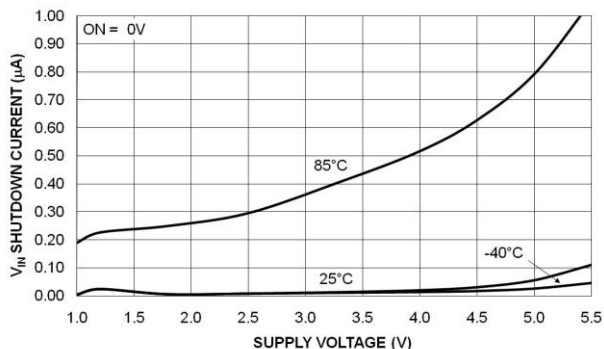


Figure 6. Shutdown Current vs. Supply Voltage

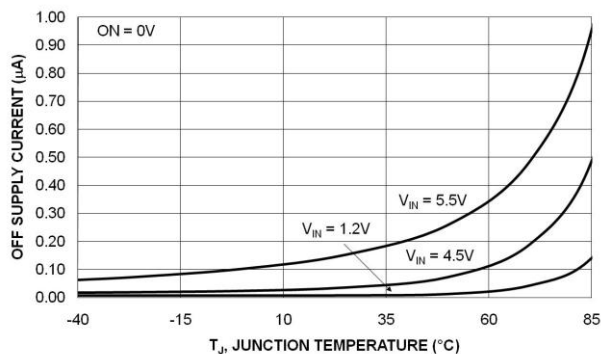


Figure 7. Off Supply Current vs. Temperature  
( $V_{OUT} = 0\text{ V}$ )

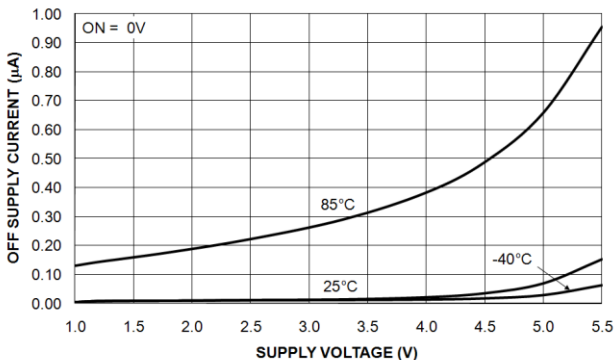


Figure 8. Off Supply Current vs. Supply Voltage  
( $V_{OUT} = 0\text{ V}$ )

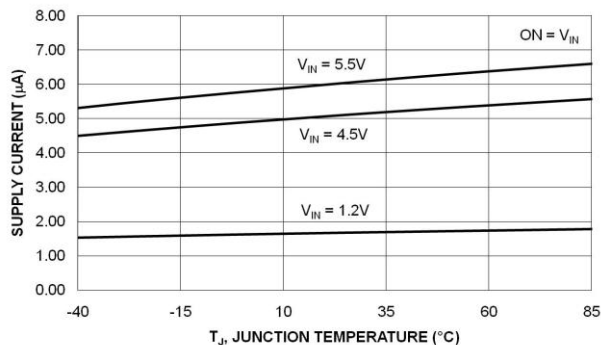


Figure 9. Quiescent Current vs. Temperature

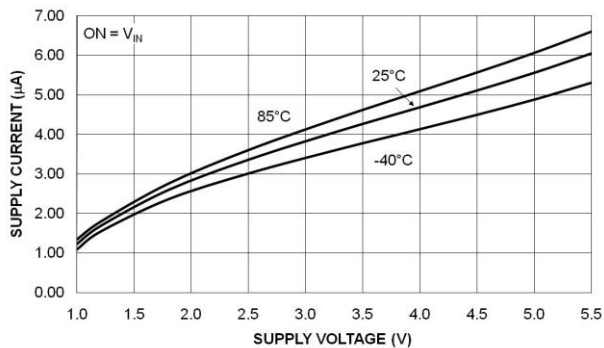
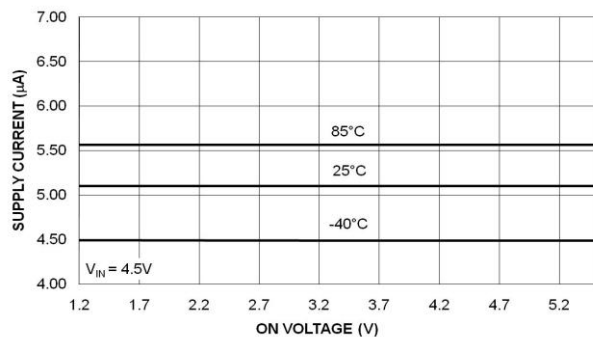
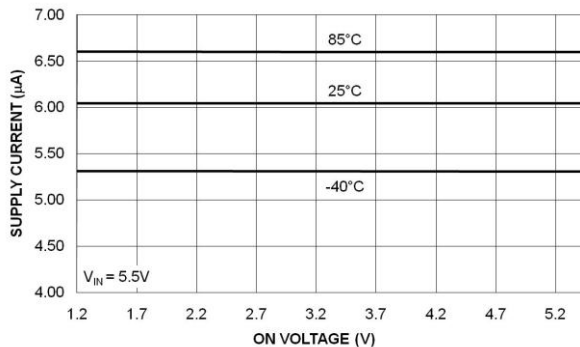


Figure 10. Quiescent Current vs. Supply Voltage

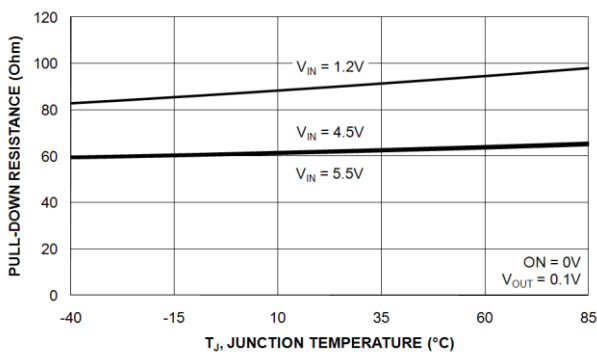
**Typical Characteristics (Continued)**



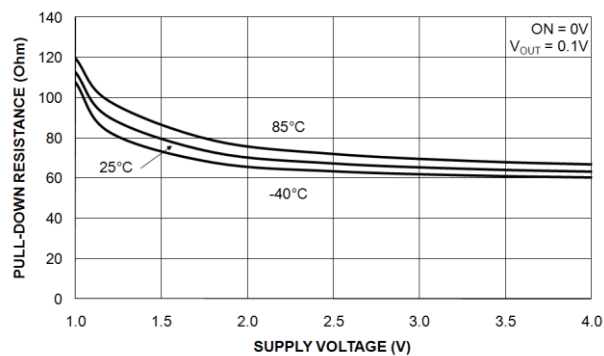
**Figure 11. Quiescent Current vs. On Voltage ( $V_{IN} = 4.5V$ )**



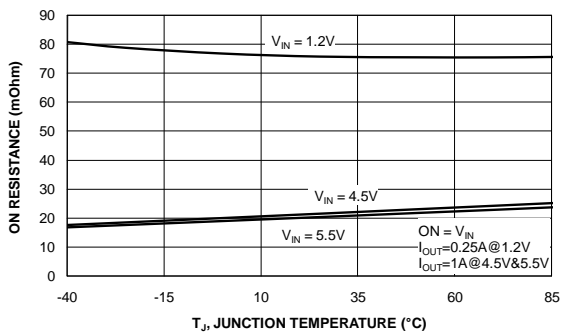
**Figure 12. Quiescent Current vs. On Voltage ( $V_{IN} = 5.5V$ )**



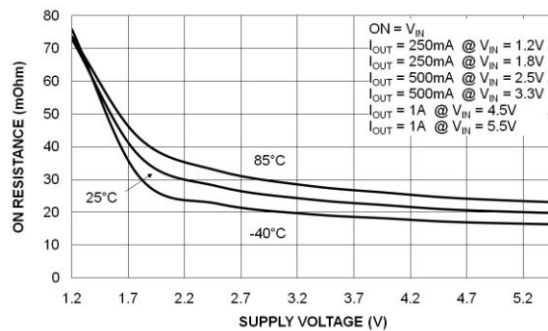
**Figure 13. Output Discharge Resistor RPD vs. Temperature**



**Figure 14. Output Discharge Resistor RPD vs. Supply Voltage**



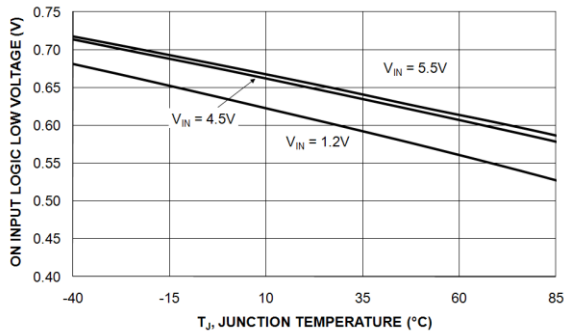
**Figure 15.  $R_{ON}$  vs. Temperature**



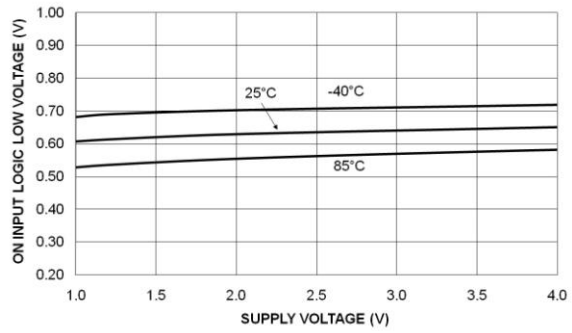
**Figure 16.  $R_{ON}$  vs. Supply Voltage**



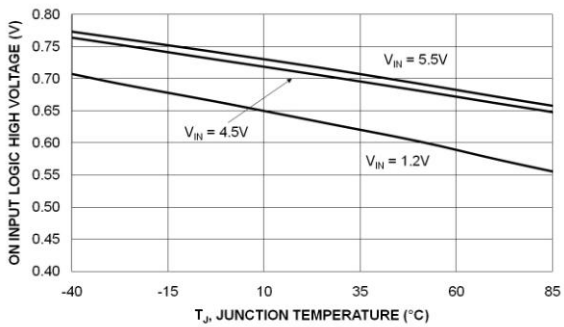
**Typical Characteristics (Continued)**



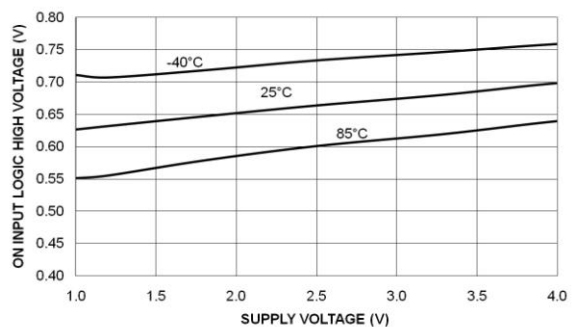
**Figure 17. On Pin Threshold Low vs. Temperature**



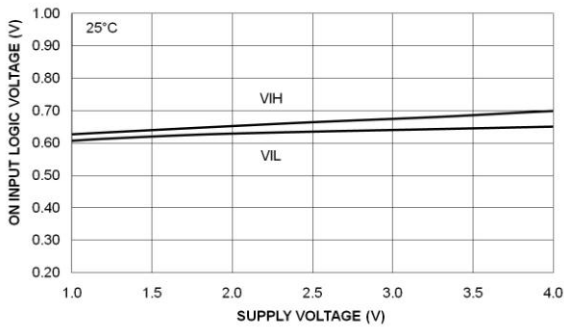
**Figure 18. On Pin Threshold Low vs.  $V_{IN}$**



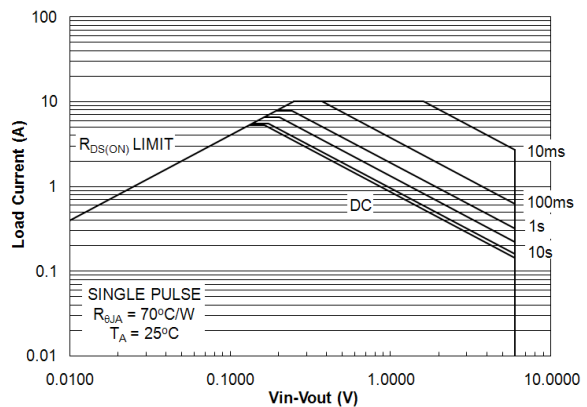
**Figure 19. On Pin Threshold High vs. Temperature**



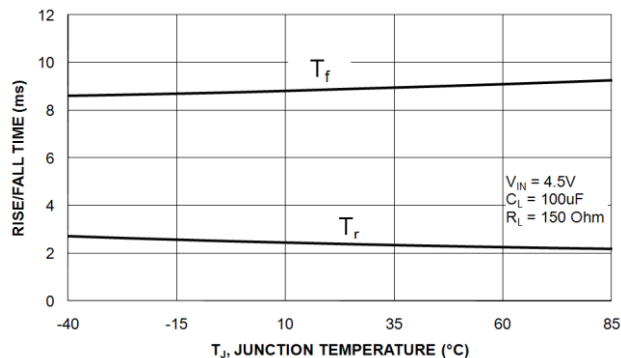
**Figure 20. On Pin Threshold High vs.  $V_{IN}$**



**Figure 21. On Pin Threshold vs. Supply Voltage**

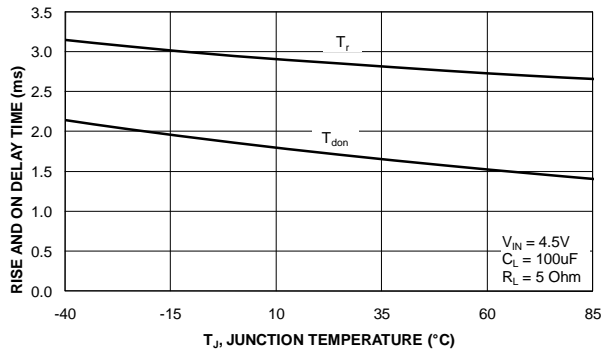


**Figure 22.  $I_{SW}$  vs.  $(V_{IN}-V_{OUT})$  — SOA**

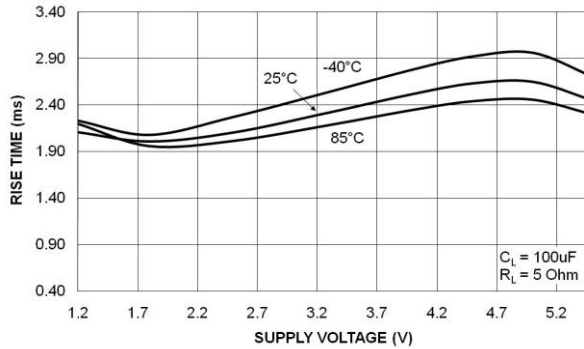


**Figure 23.  $t_R/t_F$  vs. Temperature**

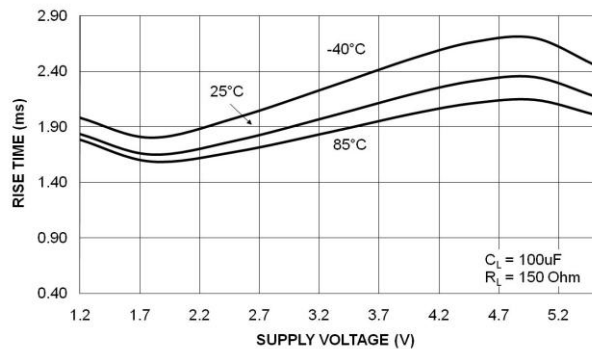
**Typical Characteristics (Continued)**



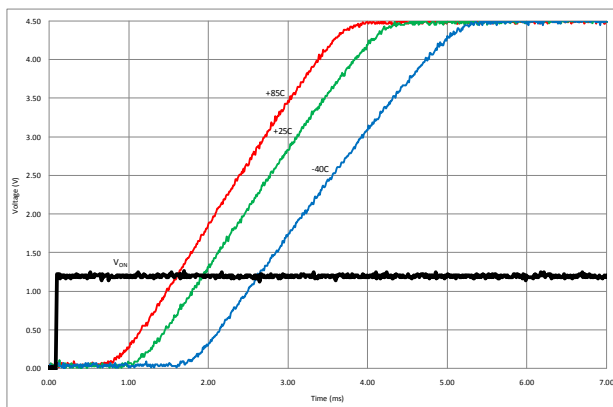
**Figure 24.  $t_R/t_{DON}$  vs. Temperature**



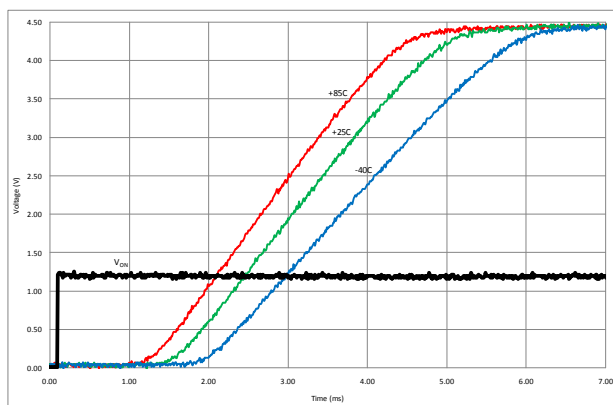
**Figure 25.  $t_R$  vs. Supply Voltage**



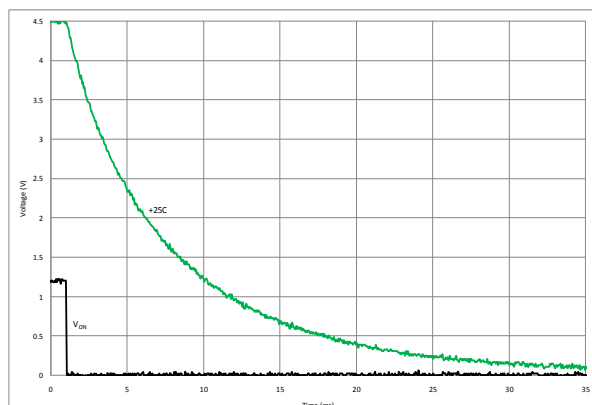
**Figure 26.  $t_R$  vs. Supply Voltage**



**Figure 27. Turn-On Response**  
( $V_{IN}=4.5\text{ V}$ ,  $C_{IN}=10\ \mu\text{F}$ ,  $C_L=1\ \mu\text{F}$ ,  $R_L=50\ \Omega$ )

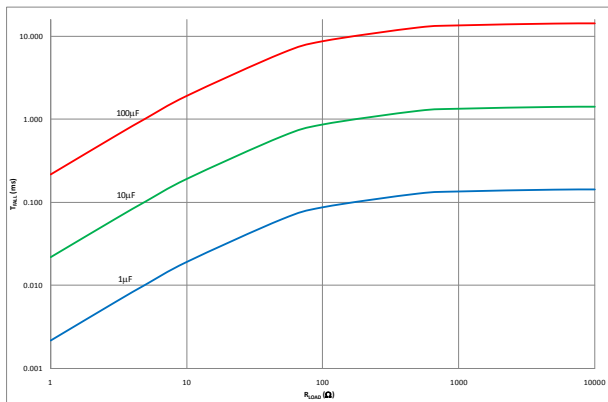


**Figure 28. Turn-On Response**  
( $V_{IN}=4.5\text{ V}$ ,  $C_{IN}=10\ \mu\text{F}$ ,  $C_L=100\ \mu\text{F}$ ,  $R_L=5\ \Omega$ )

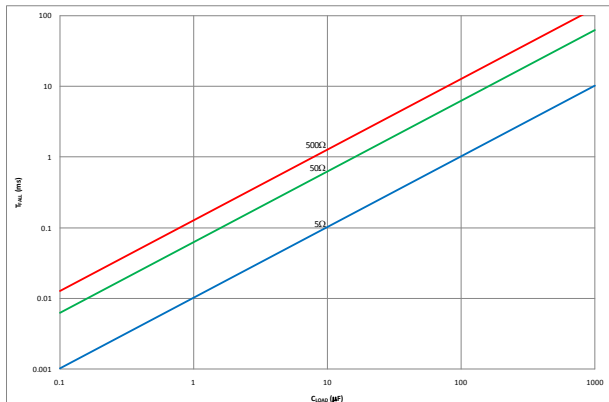


**Figure 29. Turn-Off Response**  
( $V_{IN}=4.5\text{ V}$ ,  $C_{IN}=10\ \mu\text{F}$ ,  $C_L=100\ \mu\text{F}$ , without External  $R_L$ )

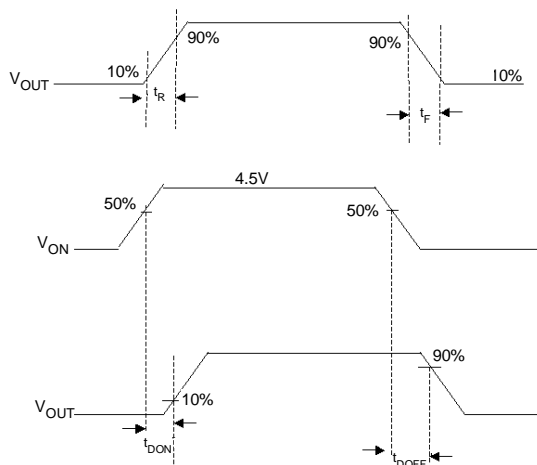
**Typical Characteristics** (Continued)



**Figure 30. Fall Time as a Function of External Resistive Load ( $C_L=1\mu F$ ,  $10\mu F$ , and  $100\mu F$ )**



**Figure 31. Fall Time as a Function of External Capacitive Load ( $R_L=5\Omega$ ,  $50\Omega$ , and  $500\Omega$ )**



**Figure 32. Timing Diagram**

## Application Information

### Input Capacitor

This IntelliMAX™ switch doesn't require an input capacitor. To reduce device inrush current, a 0.1 μF ceramic capacitor, C<sub>IN</sub>, is recommended close to the VIN pin. A higher value of C<sub>IN</sub> can be used to reduce the voltage drop experienced as the switch is turned on into a large capacitive load.

### Output Capacitor

While this switch works without an output capacitor: if parasitic board inductance forces V<sub>OUT</sub> below GND when switching off; a 0.1 μF capacitor, C<sub>OUT</sub>, should be placed between V<sub>OUT</sub> and GND.

### Fall Time

Device output fall time can be calculated based on RC constant of the external components as follows:

$$t_F = R_L \times C_L \times 2.2 \quad (1)$$

where t<sub>F</sub> is 90% to 10% fall time, R<sub>L</sub> is output load, and C<sub>L</sub> is output capacitor.

The same equation works for a device with a pull-down output resistor. R<sub>L</sub> is replaced by a parallel connected pull-down and an external output resistor combination as:

$$t_F = \frac{R_L \times R_{PD}}{R_L + R_{PD}} \times C_L \times 2.2 \quad (2)$$

where t<sub>F</sub> is 90% to 10% fall time, R<sub>L</sub> is output load, R<sub>PD</sub>=65 Ω is output pull-down resistor, and C<sub>L</sub> is the output capacitor.

### Resistive Output Load

If resistive output load is missing, the IntelliMAX switch without a pull-down output resistor does not discharge the output voltage. Output voltage drop depends, in that case, mainly on external device leaks.

### Application Specifics

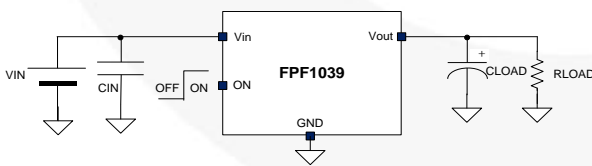


Figure 33. Device Setup

At maximum operational voltage (V<sub>IN</sub>=5.5 V), device inrush current might be higher than expected. Spike current should be taken into account if V<sub>IN</sub>>5 V and the output capacitor is much larger than the input capacitor. Input current can be calculated as:

$$I_{IN}(t) \approx \frac{V_{OUT}(t)}{R_{LOAD}} + (C_{LOAD} - C_{IN}) \frac{dV_{OUT}(t)}{dt} \quad (3)$$

where switch and wire resistances are neglected and capacitors are assumed ideal.

Estimating V<sub>OUT</sub>(t)=V<sub>IN</sub>/10 and using experimental formula for slew rate (dV<sub>OUT</sub>(t)/dt), spike current can be written as:

$$\max(I_{IN}) = \frac{V_{IN}}{10R_{LOAD}} + (C_{LOAD} - C_{IN}) (0.05V_{IN} - 0.255) \quad (4)$$

where supply voltage V<sub>IN</sub> is in volts, capacitances are in micro farads, and resistance is in ohms.

Example: If V<sub>IN</sub>=5.5V, C<sub>LOAD</sub>=100 μF, C<sub>IN</sub>=10 μF, and R<sub>LOAD</sub>=50 Ω; calculate the spike current by:

$$\max(I_{IN}) = \frac{5.5}{10 \times 50} + (100 - 10)(0.05 \times 5.5 - 0.255) A = 1.8 A \quad (5)$$

Maximum spike current is 1.8 A, while average ramp-up current is:

$$I_{IN}(t) \approx \frac{V_{OUT}(t)}{R_{LOAD}} + (C_{LOAD} - C_{IN}) \frac{dV_{IN}(t)}{dt} \quad (6)$$

$$\approx 2.75 / 50 + 100 \times 0.0022 = 0.275 A$$

### Output Discharge

FPF1039 contains a 65 Ω on-chip pull-down resistor for quick output discharge. The resistor is activated when the switch is turned off.

### Recommended Layout

For best thermal performance and minimal inductance and parasitic effects, it is recommended to keep input and output traces short and capacitors as close to the device as possible. Figure 34 is a recommended layout for this device to achieve optimum performance.

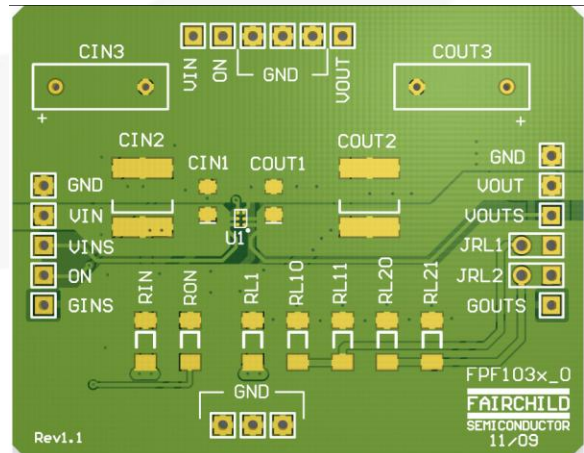
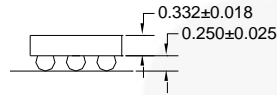
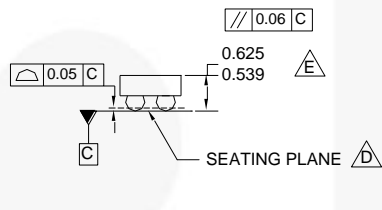
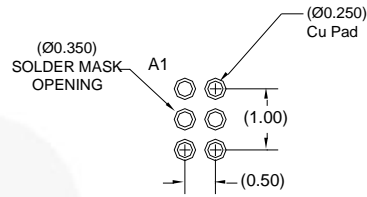
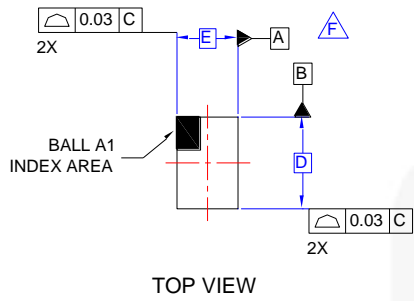
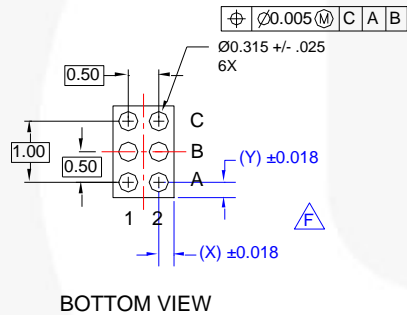


Figure 34. Recommended Land Pattern, Layout

### Physical Dimensions



SIDE VIEWS



BOTTOM VIEW

**NOTES:**

- A. NO JEDEC REGISTRATION APPLIES.
- B. DIMENSIONS ARE IN MILLIMETERS.
- C. DIMENSIONS AND TOLERANCE PER ASMEY14.5M, 1994.
- D. DATUM C IS DEFINED BY THE SPHERICAL CROWNS OF THE BALLS.
- E. PACKAGE NOMINAL HEIGHT IS 582 MICRONS ±43 MICRONS (539-625 MICRONS).
- F. FOR DIMENSIONS D, E, X, AND Y SEE PRODUCT DATASHEET.
- G. DRAWING FILNAME: MKT-UC006AFrev2.

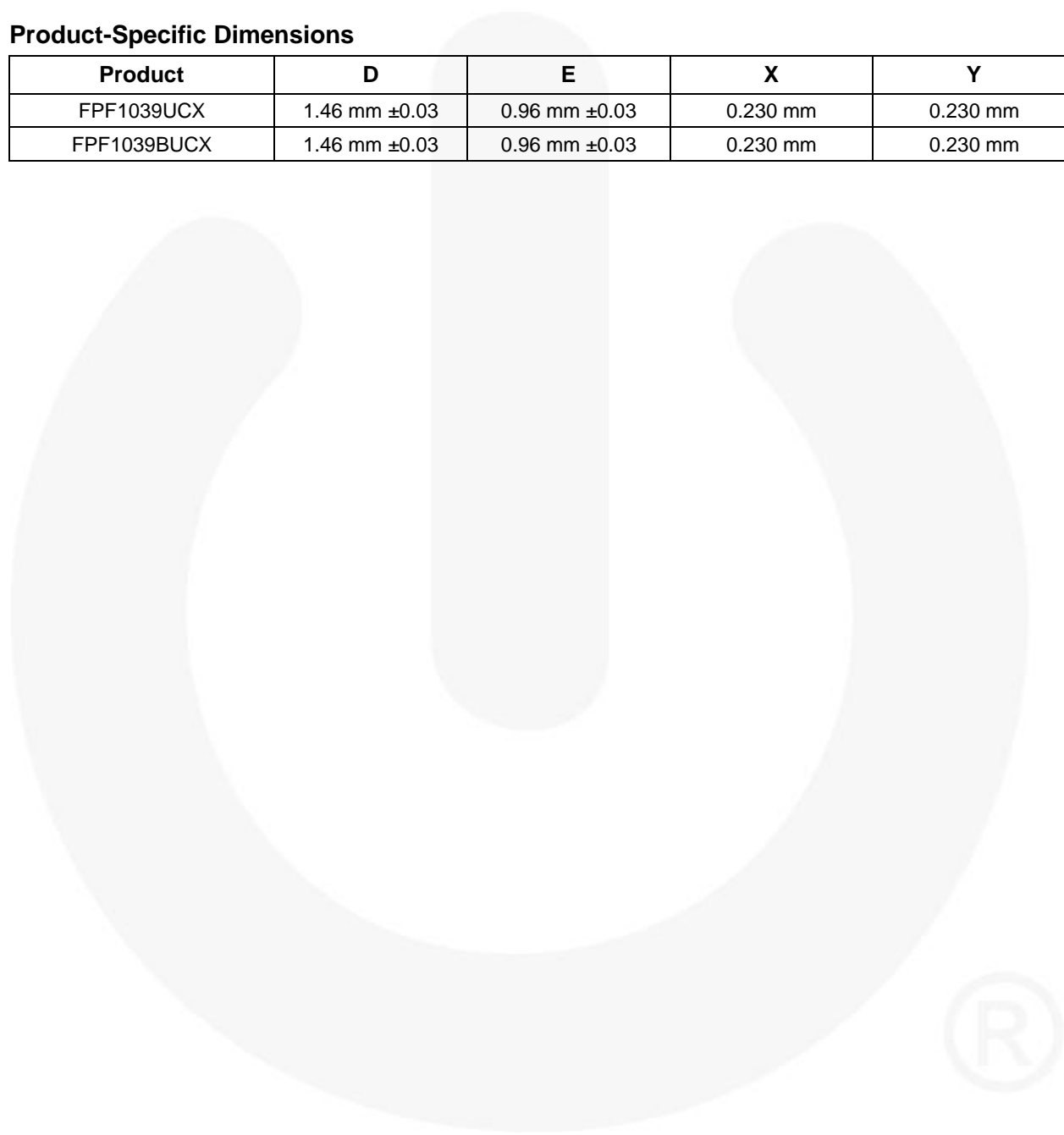
**Figure 35. 6 Ball, 1.0 x 1.5 mm Wafer-Level Chip-Scale Packaging (WLCSP)**

**Nominal Values**

Bump Pitch	Overall Package Height	Silicon Thickness	Solder Bump Height	Solder Bump Diameter
0.5 mm	0.582 mm	0.332 mm	0.250 mm	0.315 mm

**Product-Specific Dimensions**

Product	D	E	X	Y
FPF1039UCX	1.46 mm $\pm$ 0.03	0.96 mm $\pm$ 0.03	0.230 mm	0.230 mm
FPF1039BUCX	1.46 mm $\pm$ 0.03	0.96 mm $\pm$ 0.03	0.230 mm	0.230 mm





**TRADEMARKS**

The following includes registered and unregistered trademarks and service marks, owned by Fairchild Semiconductor and/or its global subsidiaries, and is not intended to be an exhaustive list of all such trademarks.

- |                          |  |                                       |                  |
|--------------------------|--|---------------------------------------|------------------|
| AccuPower™               | F-PFS™   | OPTOPLANAR®                           |                  |
| AttitudeEngine™          | FRFET®   |                                       |                  |
| Awinda®                  | Global Power Resource™                         |                                       | TinyBoost®       |
| AX-CAP®*                 | GreenBridge™                                   | Power Supply WebDesigner™             | TinyBuck®        |
| BitSiC™                  | Green FPS™                                     | PowerTrench®                          | TinyCalc™        |
| Build it Now™            | Green FPS™ e-Series™                           | PowerXS™                              | TinyLogic®       |
| CorePLUS™                | Gmax™  | Programmable Active Droop™            | TINYOPTO™        |
| CorePOWER™               | GTO™   | QFET®                                 | TinyPower™       |
| CROSSVOL™                | IntelliMAX™                                    | QS™                                   | TinyPWM™         |
| CTL™                     | ISOPLANAR™                                     | Quiet Series™                         | TinyWire™        |
| Current Transfer Logic™  | Making Small Speakers Sound Louder and Better™ | RapidConfigure™                       | TranSiC™         |
| DEUXPEED®                | MegaBuck™                                      |                                       | TriFault Detect™ |
| Dual Cool™               | MICROCOUPLER™                                  | Saving our world, 1mW/W/kW at a time™ | TRUECURRENT®*    |
| EcoSPARK®                | MicroFET™                                      | SignalWise™                           | μSerDes™         |
| EfficientMax™            | MicroPak™                                      | SmartMax™                             |                  |
| ESBC™                    | MicroPak2™                                     | SMART START™                          | UHC®             |
|                          | MillerDrive™                                   | Solutions for Your Success™           | Ultra FRFET™     |
| Fairchild®               | MotionMax™                                     | SPM®                                  | UniFET™          |
| Fairchild Semiconductor® | MotionGrid®                                    | STEALTH™                              | VCX™             |
| FACT Quiet Series™       | MTI®   | SuperFET®                             | VisualMax™       |
| FACT®                    | MTx®   | SuperSOT™-3                           | VoltagePlus™     |
| FAST®                    | MVN®   | SuperSOT™-6                           | XS™              |
| FastvCore™               | mWSaver®                                       | SuperSOT™-8                           | Xsens™           |
| FETBench™                | OptoHiT™                                       | SupreMOS®                             | 仙童™              |
| FPS™                     | OPTOLOGIC®                                     | SyncFET™                              |                  |
|                          |  | Sync-Lock™                            |                  |

\* Trademarks of System General Corporation, used under license by Fairchild Semiconductor.

**DISCLAIMER**

FAIRCHILD SEMICONDUCTOR RESERVES THE RIGHT TO MAKE CHANGES WITHOUT FURTHER NOTICE TO ANY PRODUCTS HEREIN TO IMPROVE RELIABILITY, FUNCTION, OR DESIGN. TO OBTAIN THE LATEST, MOST UP-TO-DATE DATASHEET AND PRODUCT INFORMATION, VISIT OUR WEBSITE AT [HTTP://WWW.FAIRCHILDSEMI.COM](http://www.fairchildsemi.com). FAIRCHILD DOES NOT ASSUME ANY LIABILITY ARISING OUT OF THE APPLICATION OR USE OF ANY PRODUCT OR CIRCUIT DESCRIBED HEREIN; NEITHER DOES IT CONVEY ANY LICENSE UNDER ITS PATENT RIGHTS, NOR THE RIGHTS OF OTHERS. THESE SPECIFICATIONS DO NOT EXPAND THE TERMS OF FAIRCHILD'S WORLDWIDE TERMS AND CONDITIONS, SPECIFICALLY THE WARRANTY THEREIN, WHICH COVERS THESE PRODUCTS.

**LIFE SUPPORT POLICY**

FAIRCHILD'S PRODUCTS ARE NOT AUTHORIZED FOR USE AS CRITICAL COMPONENTS IN LIFE SUPPORT DEVICES OR SYSTEMS WITHOUT THE EXPRESS WRITTEN APPROVAL OF FAIRCHILD SEMICONDUCTOR CORPORATION.

As used herein:

1. Life support devices or systems are devices or systems which, (a) are intended for surgical implant into the body or (b) support or sustain life, and (c) whose failure to perform when properly used in accordance with instructions for use provided in the labeling, can be reasonably expected to result in a significant injury of the user.
2. A critical component in any component of a life support, device, or system whose failure to perform can be reasonably expected to cause the failure of the life support device or system, or to affect its safety or effectiveness.

**ANTI-COUNTERFEITING POLICY**

Fairchild Semiconductor Corporation's Anti-Counterfeiting Policy. Fairchild's Anti-Counterfeiting Policy is also stated on our external website, [www.fairchildsemi.com](http://www.fairchildsemi.com), under Sales Support.

Counterfeiting of semiconductor parts is a growing problem in the industry. All manufacturers of semiconductor products are experiencing counterfeiting of their parts. Customers who inadvertently purchase counterfeit parts experience many problems such as loss of brand reputation, substandard performance, failed applications, and increased cost of production and manufacturing delays. Fairchild is taking strong measures to protect ourselves and our customers from the proliferation of counterfeit parts. Fairchild strongly encourages customers to purchase Fairchild parts either directly from Fairchild or from Authorized Fairchild Distributors who are listed by country on our web page cited above. Products customers buy either from Fairchild directly or from Authorized Fairchild Distributors are genuine parts, have full traceability, meet Fairchild's quality standards for handling and storage and provide access to Fairchild's full range of up-to-date technical and product information. Fairchild and our Authorized Distributors will stand behind all warranties and will appropriately address any warranty issues that may arise. Fairchild will not provide any warranty coverage or other assistance for parts bought from Unauthorized Sources. Fairchild is committed to combat this global problem and encourage our customers to do their part in stopping this practice by buying direct or from authorized distributors.

**PRODUCT STATUS DEFINITIONS**

**Definition of Terms**

Datasheet Identification	Product Status	Definition
Advance Information	Formative / In Design	Datasheet contains the design specifications for product development. Specifications may change in any manner without notice.
Preliminary	First Production	Datasheet contains preliminary data; supplementary data will be published at a later date. Fairchild Semiconductor reserves the right to make changes at any time without notice to improve design.
No Identification Needed	Full Production	Datasheet contains final specifications. Fairchild Semiconductor reserves the right to make changes at any time without notice to improve the design.
Obsolete	Not In Production	Datasheet contains specifications on a product that is discontinued by Fairchild Semiconductor. The datasheet is for reference information only.

Rev. I74

ON Semiconductor and  are trademarks of Semiconductor Components Industries, LLC dba ON Semiconductor or its subsidiaries in the United States and/or other countries. ON Semiconductor owns the rights to a number of patents, trademarks, copyrights, trade secrets, and other intellectual property. A listing of ON Semiconductor's product/patent coverage may be accessed at [www.onsemi.com/site/pdf/Patent-Marking.pdf](http://www.onsemi.com/site/pdf/Patent-Marking.pdf). ON Semiconductor reserves the right to make changes without further notice to any products herein. ON Semiconductor makes no warranty, representation or guarantee regarding the suitability of its products for any particular purpose, nor does ON Semiconductor assume any liability arising out of the application or use of any product or circuit, and specifically disclaims any and all liability, including without limitation special, consequential or incidental damages. Buyer is responsible for its products and applications using ON Semiconductor products, including compliance with all laws, regulations and safety requirements or standards, regardless of any support or applications information provided by ON Semiconductor. "Typical" parameters which may be provided in ON Semiconductor data sheets and/or specifications can and do vary in different applications and actual performance may vary over time. All operating parameters, including "Typicals" must be validated for each customer application by customer's technical experts. ON Semiconductor does not convey any license under its patent rights nor the rights of others. ON Semiconductor products are not designed, intended, or authorized for use as a critical component in life support systems or any FDA Class 3 medical devices or medical devices with a same or similar classification in a foreign jurisdiction or any devices intended for implantation in the human body. Should Buyer purchase or use ON Semiconductor products for any such unintended or unauthorized application, Buyer shall indemnify and hold ON Semiconductor and its officers, employees, subsidiaries, affiliates, and distributors harmless against all claims, costs, damages, and expenses, and reasonable attorney fees arising out of, directly or indirectly, any claim of personal injury or death associated with such unintended or unauthorized use, even if such claim alleges that ON Semiconductor was negligent regarding the design or manufacture of the part. ON Semiconductor is an Equal Opportunity/Affirmative Action Employer. This literature is subject to all applicable copyright laws and is not for resale in any manner.

## PUBLICATION ORDERING INFORMATION

### LITERATURE FULFILLMENT:

Literature Distribution Center for ON Semiconductor  
19521 E. 32nd Pkwy, Aurora, Colorado 80011 USA  
**Phone:** 303-675-2175 or 800-344-3860 Toll Free USA/Canada  
**Fax:** 303-675-2176 or 800-344-3867 Toll Free USA/Canada  
**Email:** [orderlit@onsemi.com](mailto:orderlit@onsemi.com)

**N. American Technical Support:** 800-282-9855 Toll Free  
USA/Canada  
**Europe, Middle East and Africa Technical Support:**  
Phone: 421 33 790 2910  
**Japan Customer Focus Center**  
Phone: 81-3-5817-1050

**ON Semiconductor Website:** [www.onsemi.com](http://www.onsemi.com)  
**Order Literature:** <http://www.onsemi.com/orderlit>  
For additional information, please contact your local  
Sales Representative