

Rev	AWO #	Description	Date	Appr
-		RELEASED	9/27/21	

APPROVED: _____

DATE: _____ TITLE: _____

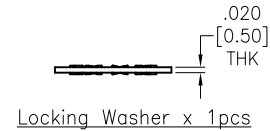
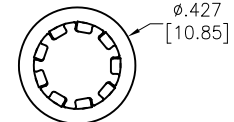
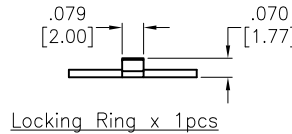
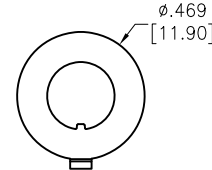
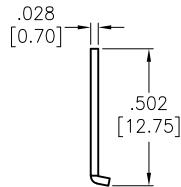
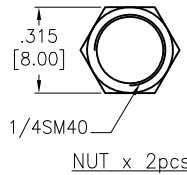
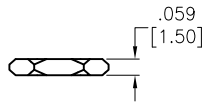
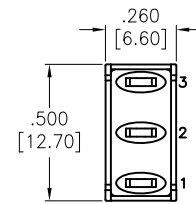
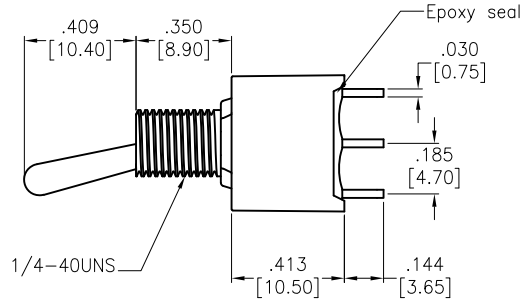
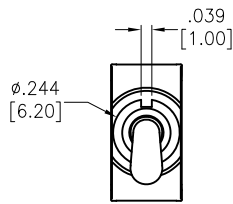
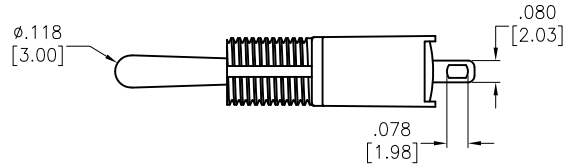

SW-T2-2B-A-T1-X-03
 S=Contact Silver Plated
 G=Contact Gold Plated

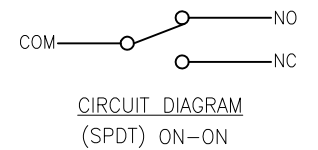

SPECIFICATIONS:

Material:
 Movable contact: Copper Alloy, Silver plated
 Terminals: Silver plated with outer layer in Gold plating
 Electrical:
 Rating: 5 Amps with resistive load @ 125VAC or 28VDC
 2 Amps with resistive load @ 250VAC
 Contact resistance: 10 mohms max initial
 Insulation resistance: 1000 Mohms min
 Dielectric withstanding voltage: 1500V RMS @ sea level
 Electrical life: 50,000 make and break cycles at full load
 Temperature Rating:
 Operating temperature: -30°C to +85°C
 Environmental:
 IP Class: IP67
 Lead free, RoHS compliant



UNLESS OTHERWISE SPECIFIED ALL DIMENSIONS ARE INCHES [MM]. TOLERANCES: EXCEPT AS NOTED		
INCHES		HOLES
.X ± .10	ØX ± .10	
.XX ± .020	ØXX ± .015	
.XXX ± .015	ØXXX ± .010	



909 Rahway Avenue,
 Union, NJ 07083
 Phone: 908-687-5000
 Fax: 908-687-5710

DRAWN	JJ	9/27/21
CHECKED	RC	9/27/21
APPROVED		

TITLE
**MINIATURE TOGGLE SWITCH,
 SPDT, ON-ON, SOLDER TYPE**

THIS DRAWING CONTAINS INFORMATION THAT IS PROPRIETARY AND SHOULD NOT BE USED WITHOUT PRIOR WRITTEN PERMISSION FROM ADAM TECH

SIZE	PART NO.	REV.
X	SW-T2-2B-A-T1-X-03	-
REF: S00198T	SCALE: NTS	SHEET 1 OF 1