



**MCP1252 Charge Pump
Backlight LED Demo Board
User's Guide**

Note the following details of the code protection feature on Microchip devices:

- Microchip products meet the specification contained in their particular Microchip Data Sheet.
- Microchip believes that its family of products is one of the most secure families of its kind on the market today, when used in the intended manner and under normal conditions.
- There are dishonest and possibly illegal methods used to breach the code protection feature. All of these methods, to our knowledge, require using the Microchip products in a manner outside the operating specifications contained in Microchip's Data Sheets. Most likely, the person doing so is engaged in theft of intellectual property.
- Microchip is willing to work with the customer who is concerned about the integrity of their code.
- Neither Microchip nor any other semiconductor manufacturer can guarantee the security of their code. Code protection does not mean that we are guaranteeing the product as "unbreakable."

Code protection is constantly evolving. We at Microchip are committed to continuously improving the code protection features of our products. Attempts to break Microchip's code protection feature may be a violation of the Digital Millennium Copyright Act. If such acts allow unauthorized access to your software or other copyrighted work, you may have a right to sue for relief under that Act.

Information contained in this publication regarding device applications and the like is provided only for your convenience and may be superseded by updates. It is your responsibility to ensure that your application meets with your specifications. MICROCHIP MAKES NO REPRESENTATIONS OR WARRANTIES OF ANY KIND WHETHER EXPRESS OR IMPLIED, WRITTEN OR ORAL, STATUTORY OR OTHERWISE, RELATED TO THE INFORMATION, INCLUDING BUT NOT LIMITED TO ITS CONDITION, QUALITY, PERFORMANCE, MERCHANTABILITY OR FITNESS FOR PURPOSE. Microchip disclaims all liability arising from this information and its use. Use of Microchip's products as critical components in life support systems is not authorized except with express written approval by Microchip. No licenses are conveyed, implicitly or otherwise, under any Microchip intellectual property rights.

Trademarks

The Microchip name and logo, the Microchip logo, Accuron, dsPIC, KEELOQ, microID, MPLAB, PIC, PICmicro, PICSTART, PRO MATE, PowerSmart, rfPIC, and SmartShunt are registered trademarks of Microchip Technology Incorporated in the U.S.A. and other countries.

AmpLab, FilterLab, Migratable Memory, MXDEV, MXLAB, PICMASTER, SEEVAL, SmartSensor and The Embedded Control Solutions Company are registered trademarks of Microchip Technology Incorporated in the U.S.A.

Analog-for-the-Digital Age, Application Maestro, dsPICDEM, dsPICDEM.net, dsPICworks, ECAN, ECONOMONITOR, FanSense, FlexROM, fuzzyLAB, In-Circuit Serial Programming, ICSP, ICEPIC, Linear Active Thermistor, MPASM, MPLIB, MPLINK, MPSIM, PICKit, PICDEM, PICDEM.net, PICLAB, PICtail, PowerCal, PowerInfo, PowerMate, PowerTool, rLAB, rfPICDEM, Select Mode, Smart Serial, SmartTel, Total Endurance and WiperLock are trademarks of Microchip Technology Incorporated in the U.S.A. and other countries.

SQTP is a service mark of Microchip Technology Incorporated in the U.S.A.

All other trademarks mentioned herein are property of their respective companies.

© 2005, Microchip Technology Incorporated, Printed in the U.S.A., All Rights Reserved.

 Printed on recycled paper.

QUALITY MANAGEMENT SYSTEM
CERTIFIED BY DNV
== ISO/TS 16949:2002 ==

Microchip received ISO/TS-16949:2002 quality system certification for its worldwide headquarters, design and wafer fabrication facilities in Chandler and Tempe, Arizona and Mountain View, California in October 2003. The Company's quality system processes and procedures are for its PICmicro® 8-bit MCUs, KEELOQ® code hopping devices, Serial EEPROMs, microperipherals, nonvolatile memory and analog products. In addition, Microchip's quality system for the design and manufacture of development systems is ISO 9001:2000 certified.



MCP1252 CHARGE PUMP BACKLIGHT LED DEMO BOARD USER'S GUIDE

Table of Contents

Preface	1
Chapter 1. Product Overview	5
1.1 Introduction	5
1.2 What is the MCP1252 Charge Pump Backlight LED Demo Board?	6
1.3 What the MCP1252 Charge Pump Backlight LED Demo Board kit includes .	6
Chapter 2. Installation and Operation	7
2.1 Introduction	7
2.2 Features	7
2.3 Getting Started	8
Appendix A. Schematic and Layouts	11
A.1 Introduction	11
A.2 Board – Schematic	12
A.3 Board – Top Assembly Drawing	13
A.4 Board – Top Layer + Silk-Screen	14
A.5 Board – Bottom Layer (From Top)	15
Appendix B. Bill-Of-Materials (BOM)	17
Appendix C. 00016R1.asm Source Code	19
C.1 Device Firmware	19
Worldwide Sales and Service	26

MCP1252 Charge Pump Backlight LED Demo Board User's Guide

NOTES:



MCP1252 CHARGE PUMP BACKLIGHT LED DEMO BOARD USER'S GUIDE

Preface

NOTICE TO CUSTOMERS

All documentation becomes dated, and this manual is no exception. Microchip tools and documentation are constantly evolving to meet customer needs, so some actual dialogs and/or tool descriptions may differ from those in this document. Please refer to our web site (www.microchip.com) to obtain the latest documentation available.

Documents are identified with a "DS" number. This number is located on the bottom of each page, in front of the page number. The numbering convention for the DS number is "DSXXXXA", where "XXXX" is the document number and "A" is the revision level of the document.

For the most up-to-date information on development tools, see the MPLAB® IDE on-line help. Select the Help menu, and then Topics to open a list of available on-line help files.

INTRODUCTION

This chapter contains general information that will be useful to know before using the MCP1252 Charge Pump Backlight LED Demo Board. Items discussed in this chapter include:

- Document Layout
- Conventions Used in this Guide
- Recommended Reading
- The Microchip Web Site
- Customer Support
- Document Revision History

DOCUMENT LAYOUT

This document describes how to use the MCP1252 Charge Pump Backlight LED Demo Board. The manual layout is as follows:

- **Chapter 1. "Product Overview"** – Important information about the MCP1252 Charge Pump Backlight LED Demo Board.
- **Chapter 2. "Installation and Operation"** – Includes instructions on how to get started with this user's guide and a description of the user's guide.
- **Appendix A. "Schematic and Layouts"** – Shows the schematic and layout diagrams for the MCP1252 Charge Pump Backlight LED Demo Board.
- **Appendix B. "Bill-Of-Materials (BOM)"** – Lists the parts used to build the MCP1252 Charge Pump Backlight LED Demo Board.
- **Appendix C. "00016R1.asm Source Code"** – Provides information about the application firmware and where the source code can be found.

MCP1252 Charge Pump Backlight LED Demo Board User's Guide

CONVENTIONS USED IN THIS GUIDE

This manual uses the following documentation conventions:

DOCUMENTATION CONVENTIONS

Description	Represents	Examples
Arial font:		
Italic characters	Referenced books	<i>MPLAB[®] IDE User's Guide</i>
	Emphasized text	...is the <i>only</i> compiler...
Initial caps	A window	the Output window
	A dialog	the Settings dialog
	A menu selection	select Enable Programmer
Quotes	A field name in a window or dialog	"Save project before build"
Underlined, italic text with right angle bracket	A menu path	<u><i>File</i></u> >Save
Bold characters	A dialog button	Click OK
	A tab	Click the Power tab
'bnnnn'	A binary number where <i>n</i> is a digit	'b00100, 'b10
Text in angle brackets < >	A key on the keyboard	Press <Enter>, <F1>
Courier font:		
Plain Courier	Sample source code	#define START
	Filenames	autoexec.bat
	File paths	c:\mcc18\h
	Keywords	_asm, _endasm, static
	Command-line options	-Opa+, -Opa-
	Bit values	0, 1
Italic Courier	A variable argument	<i>file.o</i> , where <i>file</i> can be any valid filename
0xnnnn	A hexadecimal number where <i>n</i> is a hexadecimal digit	0xFFFF, 0x007A
Square brackets []	Optional arguments	mcc18 [options] <i>file</i> [options]
Curly brackets and pipe character: { }	Choice of mutually exclusive arguments; an OR selection	errorlevel {0 1}
Ellipses...	Replaces repeated text	var_name [, var_name...]
	Represents code supplied by user	void main (void) { ... }

RECOMMENDED READING

This user's guide describes how to use MCP1252 Charge Pump Backlight LED Demo Board. The following Microchip documents are available and recommended as supplemental reference resources.

MCP1252/3 Data Sheet, "Low Noise, Positive Regulated Charge Pump", (DS21752)

This data sheet provides detailed information regarding the MCP1252/3 product family.

THE MICROCHIP WEB SITE

Microchip provides online support via our web site at www.microchip.com. This web site is used as a means to make files and information easily available to customers. Accessible by using your favorite Internet browser, the web site contains the following information:

- **Product Support** – Data sheets and errata, application notes and sample programs, design resources, user's guides and hardware support documents, latest software releases and archived software
- **General Technical Support** – Frequently Asked Questions (FAQs), technical support requests, online discussion groups, Microchip consultant program member listing
- **Business of Microchip** – Product selector and ordering guides, latest Microchip press releases, listing of seminars and events, listings of Microchip sales offices, distributors and factory representatives

CUSTOMER SUPPORT

Users of Microchip products can receive assistance through several channels:

- Distributor or Representative
- Local Sales Office
- Field Application Engineer (FAE)
- Technical Support
- Development Systems Information Line

Customers should contact their distributor, representative or field application engineer (FAE) for support. Local sales offices are also available to help customers. A listing of sales offices and locations is included in the back of this document.

Technical support is available through the web site at: <http://support.microchip.com>

In addition, there is a Development Systems Information Line which lists the latest versions of Microchip's development systems software products. This line also provides information on how customers can receive currently available upgrade kits.

The Development Systems Information Line numbers are:

1-800-755-2345 – United States and most of Canada

1-480-792-7302 – Other International Locations

DOCUMENT REVISION HISTORY

Revision A (May 2005)

- Initial Release of this Document.

MCP1252 Charge Pump Backlight LED Demo Board User's Guide

NOTES:

Chapter 1. Product Overview

1.1 INTRODUCTION

Today's new color displays require a pure white light for backlighting. White light-emitting diodes have become the component of choice. The MCP1252-ADJ is an excellent choice for biasing the backlighting or driving other LED applications. Light intensity is controlled uniformly through the use of ballast resistors. The peak intensity is set by the feedback (FB) to the the MCP1252-ADJ. Dimming is accomplished by pulse-width modulating the shutdown pin of the device.

This chapter covers the following topics:

- What is the MCP1252 Charge Pump Backlight LED Demo Board?
- What the MCP1252 Charge Pump Backlight LED Demo Board Kit Includes

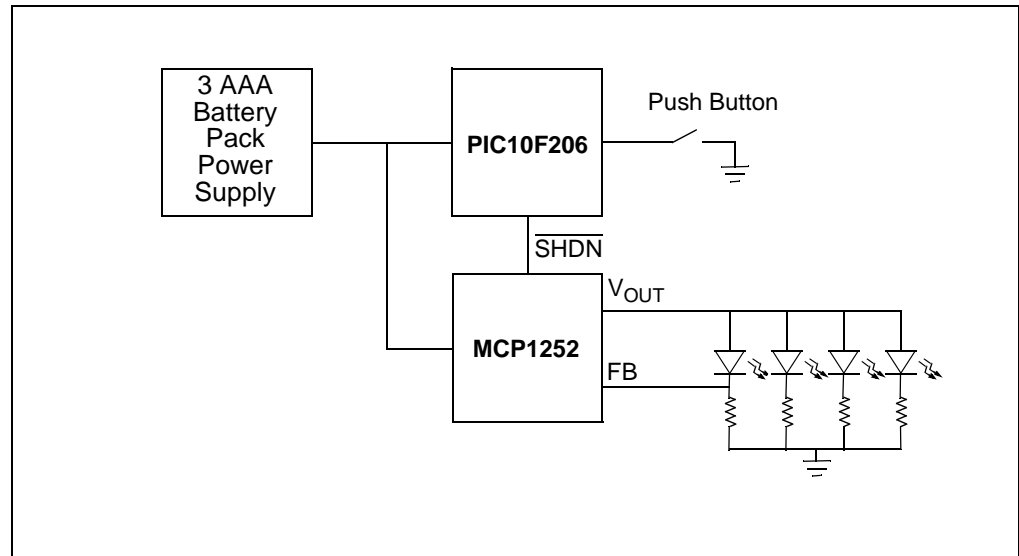

FIGURE 1-1: MCP1252 Charge Pump Backlight LED Demo Board Block Diagram.

1.2 WHAT IS THE MCP1252 CHARGE PUMP BACKLIGHT LED DEMO BOARD?

The MCP1252 Charge Pump Backlight LED Demo Board demonstrates the use of a charge pump device in a LED application. The board also serves as a platform to evaluate the MCP1252 device generally.

The MCP1252-ADJ device used in this application is an inductorless, positive-regulated charge pump DC/DC converter. The device generates an adjustable output voltage. It is specifically designed for applications requiring low noise and high efficiency, and is able to deliver up to 120 mA output current. In addition, a charge pump is a low-cost, compact and simple solution for an application, as it only requires one external capacitor to transfer charge from the input supply to the regulated output.

The MCP1252 allows the input voltage to be lower or higher than the the output voltage by automatically switching between buck and boost operation. This makes it especially suited for battery applications, allowing the system voltage to be maintained even after the batteries have discharged below the system voltage level, further extending the overall charge life of the battery.

1.3 WHAT THE MCP1252 CHARGE PUMP BACKLIGHT LED DEMO BOARD KIT INCLUDES

This MCP1252 Charge Pump Backlight LED Demo Board kit includes:

- MCP1252 Charge Pump Backlight LED Demo Board (102-00016)
- MCP1252 Charge Pump Backlight LED Demo Board User's Guide (DS51551)



MCP1252 CHARGE PUMP BACKLIGHT LED DEMO BOARD USER'S GUIDE

Chapter 2. Installation and Operation

2.1 INTRODUCTION

The MCP1252 Charge Pump Backlight LED Demo Board uses the MCP1252-ADJ to power four white LEDs. A PIC10F206 microcontroller in a SOT23 package is used to provide an enable signal to the MCP1252. It also accepts a push button input that allows the user to adjust the white LEDs to five different light intensities, in addition to placing the system in a standby mode that consumes less than 1 μA of current (typ.).

The PIC10F206 microcontroller is programmable, allowing the user to modify or develop their own firmware routines to further evaluate the MCP1252 in this application.

2.2 FEATURES

The MCP1252 Charge Pump Backlight LED Demo Board has the following features:

- Programmed MCP1252 charge pump control (via the PIC10F206)
- Four white LEDs
- PIC10F206 microcontroller
 - Enables the MCP1252 charge pump
 - Controls light intensity
 - Places system into Sleep mode ($< 1 \mu\text{A}$)
- Push button interface for multiple control options
- Baseline Flash Microcontroller Programmer (BFMP) Header for reprogramming the PIC10F206
- 3 AAA battery pack (batteries not included)

2.3 GETTING STARTED

The MCP1252 Charge Pump Backlight LED Demo Board comes fully assembled and tested. The board requires 3 AAA batteries as a power source for the application.

2.3.1 Powering the MCP1252 Charge Pump Backlight LED Demo Board

Insert three AAA batteries into the battery pack on the bottom of the board. As soon as the system powers up, the internal program of the PIC10F206 will initialize and remain in a low-power sleep mode ($<1 \mu\text{A}$) until the S1 button is pressed by the user.

The MCP1252 Charge Pump Backlight LED Demo Board does not need a power switch or power jumper because of the "standby" or "sleep" mode of the PIC10F206 microcontroller. Upon entering Sleep mode, the system requires less than $1 \mu\text{A}$ (typ) of current. So, with three AAA batteries used in the application (at 1250 mAh per battery), the system's power requirements in Sleep mode are minimal (the "shelf life" of an alkaline battery is 5-7 years, whereas the system current load in Sleep mode would discharge the battery pack in about 400 years!).

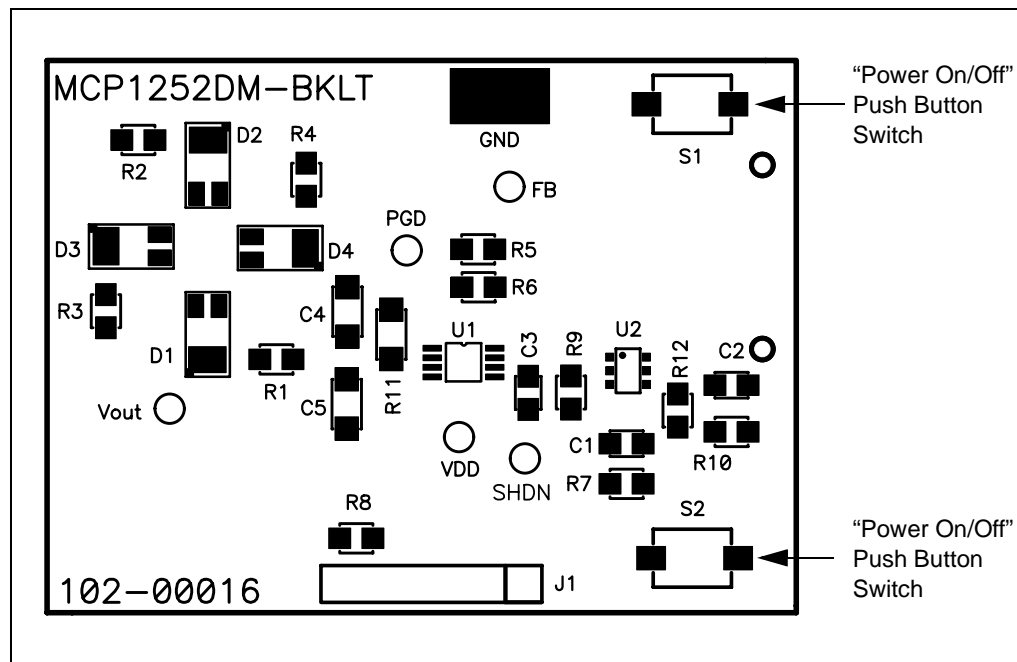

FIGURE 2-1: Setup Configuration Diagram.

Activating Application and Changing the LED intensity

1. To activate the LEDs, simply press the S1 push button. The LEDs will turn on at a low intensity level when the push button is pressed, gaining intensity when the push button is pressed again. There are 5 levels of LED intensity (plus the “off” state).

The intensity of the LEDs are controlled via the $\overline{\text{SHDN}}$ input pin of the MCP1252. A Pulse-Width Modulated (PWM) signal is generated by the PIC10F206 and routed to the SHDN input pin of the MCP1252. The MCP1252 is actually pulsed, and the duty cycle of the PWM waveform is varied, such that narrow pulses create a low-intensity condition, while wider pulses create a high-intensity condition.

2. The LEDs will be turned off, and the system will enter Sleep mode, when the LEDs are in the high-intensity state and the push button is pressed. Subsequent push button presses will cycle the LEDs as described in Step 1.

Evaluating the Application

The best way to evaluate the MCP1252 Charge Pump Backlight LED Demo Board is to dig into the circuit. Measure voltages and currents with a DVM and probe the board with an oscilloscope. Test points have been provided to simplify this task. The test points correspond to the pins of the MCP1252: PGD (= PGOOD), Vout, V_{DD} (= V_{IN}), GND, SHDN and FB.

The firmware program in the PIC10F206 can also be edited to modify the operation of the application. For example, the output signal that is routed from GP0 of the PIC10F206 to SHDN of the MCP1252 can be changed to implement different light intensities, slowly blinking the LEDs on/off or provide some other pattern. There is also an optional push button (S2) that can be used to provide additional control options to the system

Firmware

The PIC10F206 comes preprogrammed with firmware to operate the system as described above. The program file can be found on the CD that comes with the kit. The file listing and firmware flow diagram are shown in **Appendix C. “00016R1.asm Source Code”**.

The program is fairly simple and straightforward. There is an initialization routine at the beginning of the program. The constants allow for five LED intensity levels to be adjusted to the appropriate light intensity (LED_HI_ON, LED_MEDHI_ON, etc.), set the PWM period (PERIOD) and maximum time (MAX_TIME) before the unit switches back to Sleep mode. The variables track what mode the unit is in (MODE), implement counters (COUNTER, TIMERH, TIMERL), etc.

Upon resetting the processor, the ports are initialized and registers are configured in the INIT_PORTS routine. If the device has come out of Sleep mode, the MODE variable is set so the LEDs will be at low intensity. The OPTION register is configured to wake-up on Port pin change. The GPIO port is configured to set GP0 (PWM to the MCP1252) as an output and GP1, GP2 and GP3 (push button) as inputs. The processor will reset on power-up or due to a wake-up from Sleep mode. Therefore, the STATUS register needs to be tested to determine the source of the reset. If the reset occurred due to powering up the system for the first time, the program proceeds to the INIT_VARS subroutine, where the program variables are initialized. If the reset occurred due to a wake-up from Sleep mode, the program proceeds to the WAKE subroutine.

The WAKE routine tests the GPIO push button input to determine if the button has been pressed. If it has, the program goes to the INC_MODE subroutine to set the new LED intensity mode. The INC_MODE and MODE_SELECT routines determine the appropriate light intensity when the device is reset, comes out of Sleep mode, or button S1 is pressed to increment the light intensity. The LED_FULL, LED_HIGH, LED_MEDHI, LED_MED, LED_LOW, and LED_OFF routines set one of six LED settings (five light intensity settings and "off").

Programming

Header JP1 is provided for in-system circuit programming. This is an optional feature since the demo board comes pre-programmed with F/W to operate the system. The PIC10F206 can be reprogrammed with the Baseline Flash Microcontroller Programmer (BFMP).

The BFMP is a simple and easy-to-use in-circuit serial programmer intended to be used with any of Microchip's new baseline Flash PIC[®] microcontrollers, specifically, the PIC10F200/202/204/206, PIC12F508/509, PIC16F505 and PIC16F54/57/59. The BFMP provides a 6-pin linear In-Circuit Serial Programming[™] (ICSP[™]) header for standard ICSP support, as well as stand-alone programming support for the PIC10F family when paired with the PIC10F2XX programmer adapter, providing the least expensive method of programming. The BFMP utilizes USB and does not require an external power supply. The included Graphical User Interface (GUI) allows you to read, write and verify the microcontroller to be programmed.

Please refer to Microchip's web site (www.microchip.com) for additional information on the BFMP.



MCP1252 CHARGE PUMP BACKLIGHT LED DEMO BOARD USER'S GUIDE

Appendix A. Schematic and Layouts

A.1 INTRODUCTION

This appendix contains the following schematics and layouts for the MCP1252 Charge Pump Backlight LED Demo Board:

- Board – Schematic
- Board – Top Assembly Drawing
- Board – Top Layer + Silk-Screen
- Board – Bottom Layer

MCP1252 Charge Pump Backlight LED Demo Board User's Guide

A.2 BOARD – SCHEMATIC

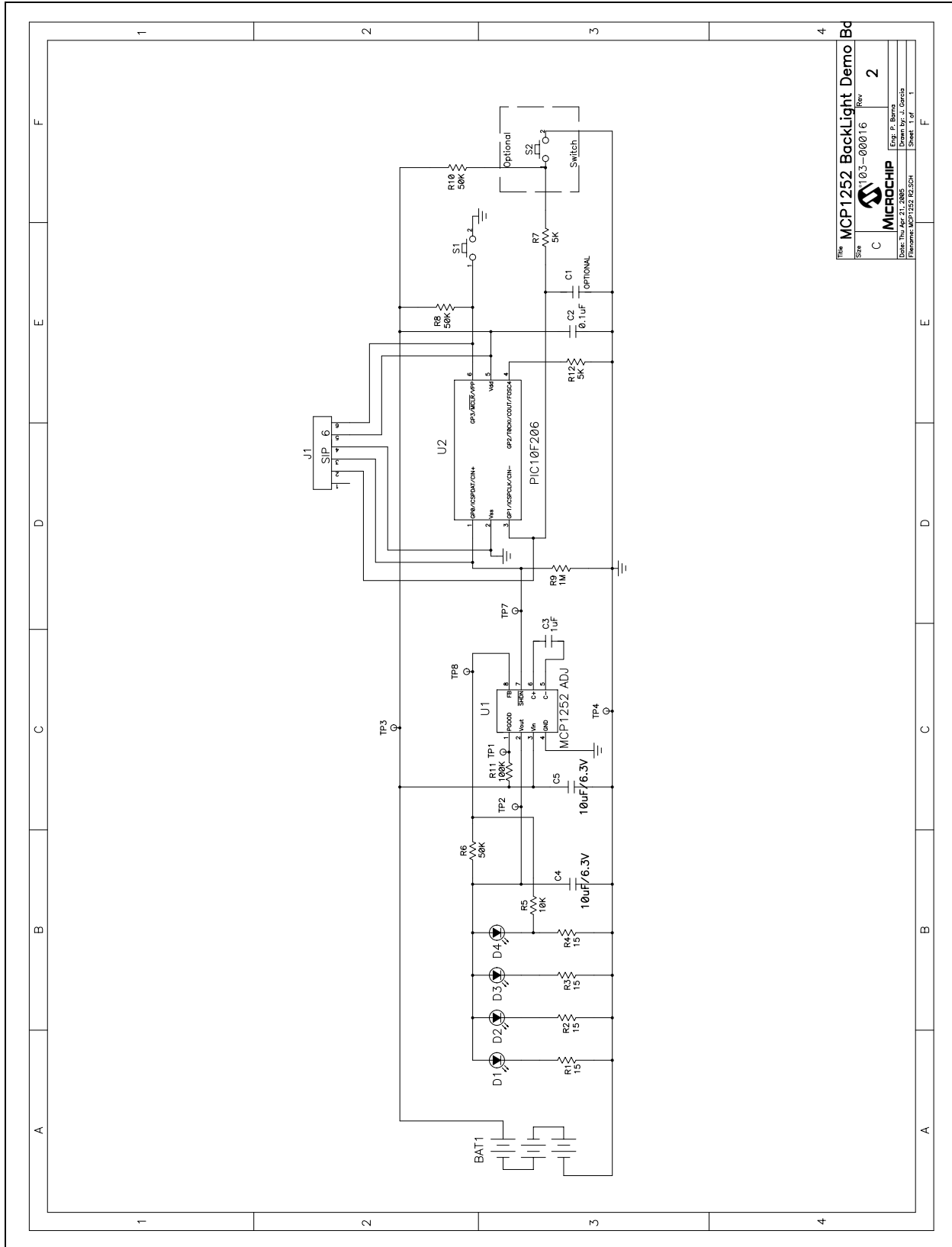

A.3 BOARD – TOP ASSEMBLY DRAWING

A	B	C	D	1	2	3	4

NOTES:

MATERIAL: FR-4, THICKNESS 0.062 COPPER 1 OZ – SIG LYRS

FINISH:

- SOLDERMASK OVER BARE COPPER (SMOBC) WITH HOT-AIR-LEVELED SOLDER
- SMOBC WITH SELECTIVE GOLD PLATING ON LANDS INDICATED, 10µI GOLD OVER 50-100µI NICKEL.
- 60/40 TIN-LEAD REFLOW

TWO LAYER BOARD

SOLDERMASK – DYNACHEM EPIC 200 LPI OR EQUIVALENT.
 COLOR – Green High Gloss
 SILKSCREEN – White

USE ARTWORK SET NO. 105-00016 REV 2

ANY ALTERNATIVES TO THE ABOVE SPECIFICATIONS MUST BE APPROVED BY THE ENGINEERING DEPARTMENT AT MICROCHIP.
 THIS PCB TO BE MANUFACTURED TO MEET ALL ACCEPTANCE LEVELS OF A CLASS 2 PCB PER ANSI/IPC-A-600F.

Drill Table

Hole Dia. (inch)	Symbol	Quantity	Plated
0.018	+	19	Yes
0.035	X	6	Yes
0.042	Y	7	Yes

Title	MCP1252DM-BKLT		
Size	B	102-00016	Rev 2
Date	02/24/05	Eng. P. Barnes	Drawn by Jose Garcia
Filename	MCP1252_B2.pcb		
		Sheet 1	of 1

ASSEMBLY NOTES:

1. ALL UNUSED COMPONENTS SHALL BE FREE OF SOLDER
2. ALL COMPONENTS SHALL BE MOUNTED FLUSH TO THE BOARD, EXCEPT AS NOTED.
3. MAXIMUM COMPONENT HEIGHT NOT TO EXCEED: 0.148 TOP SIDE, 0.048 BOTTOM SIDE
4. FINISHED BOARD SHALL BE FREE OF ALL RESIDUES.
5. THESE COMPONENTS REQUIRE SOCKETS :
6. ALL LEADS SHALL BE TRIMMED TO A MAXIMUM HEIGHT OF 0.045

A.4 BOARD – TOP LAYER + SILK-SCREEN

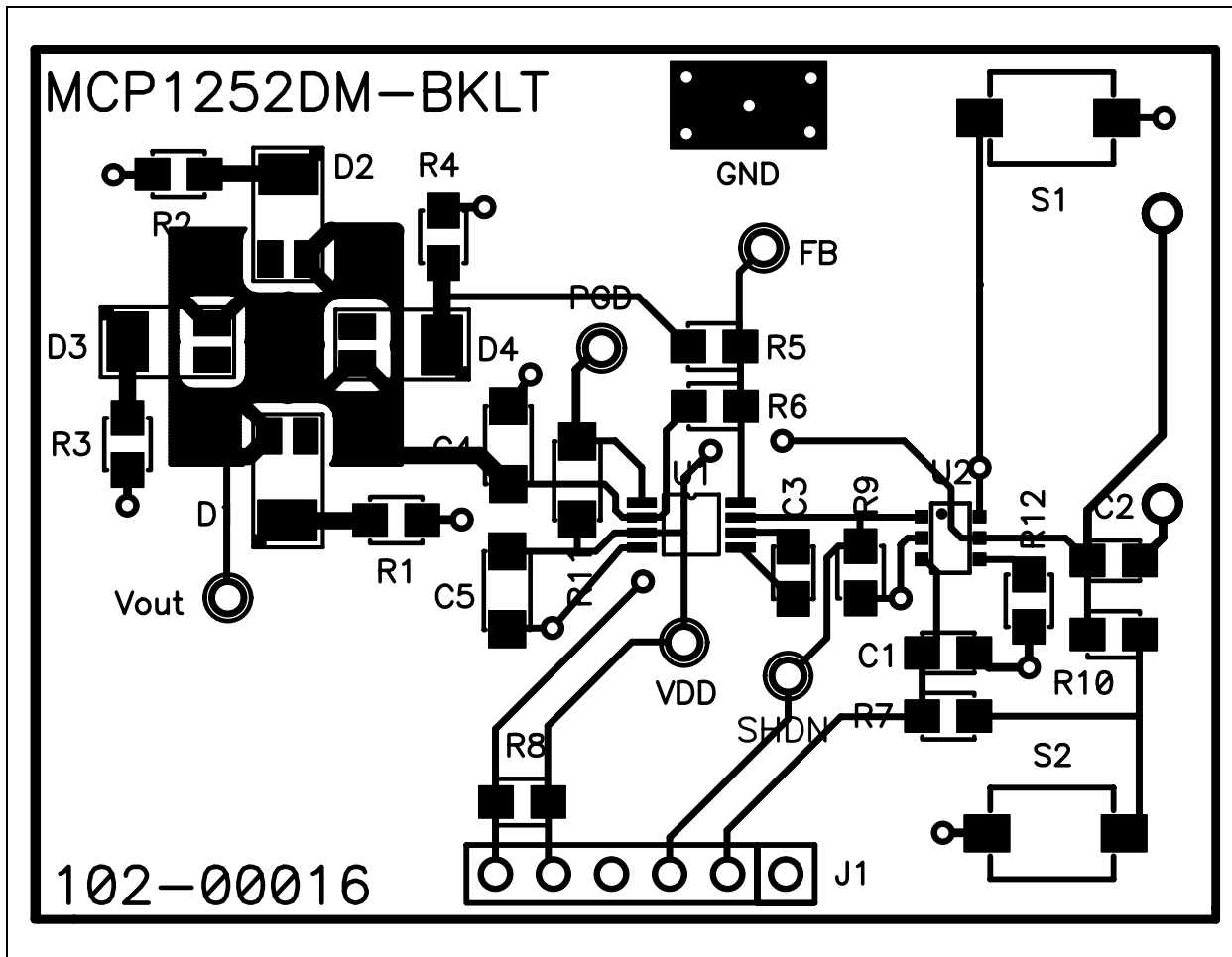

A.5 BOARD – BOTTOM LAYER (FROM TOP)

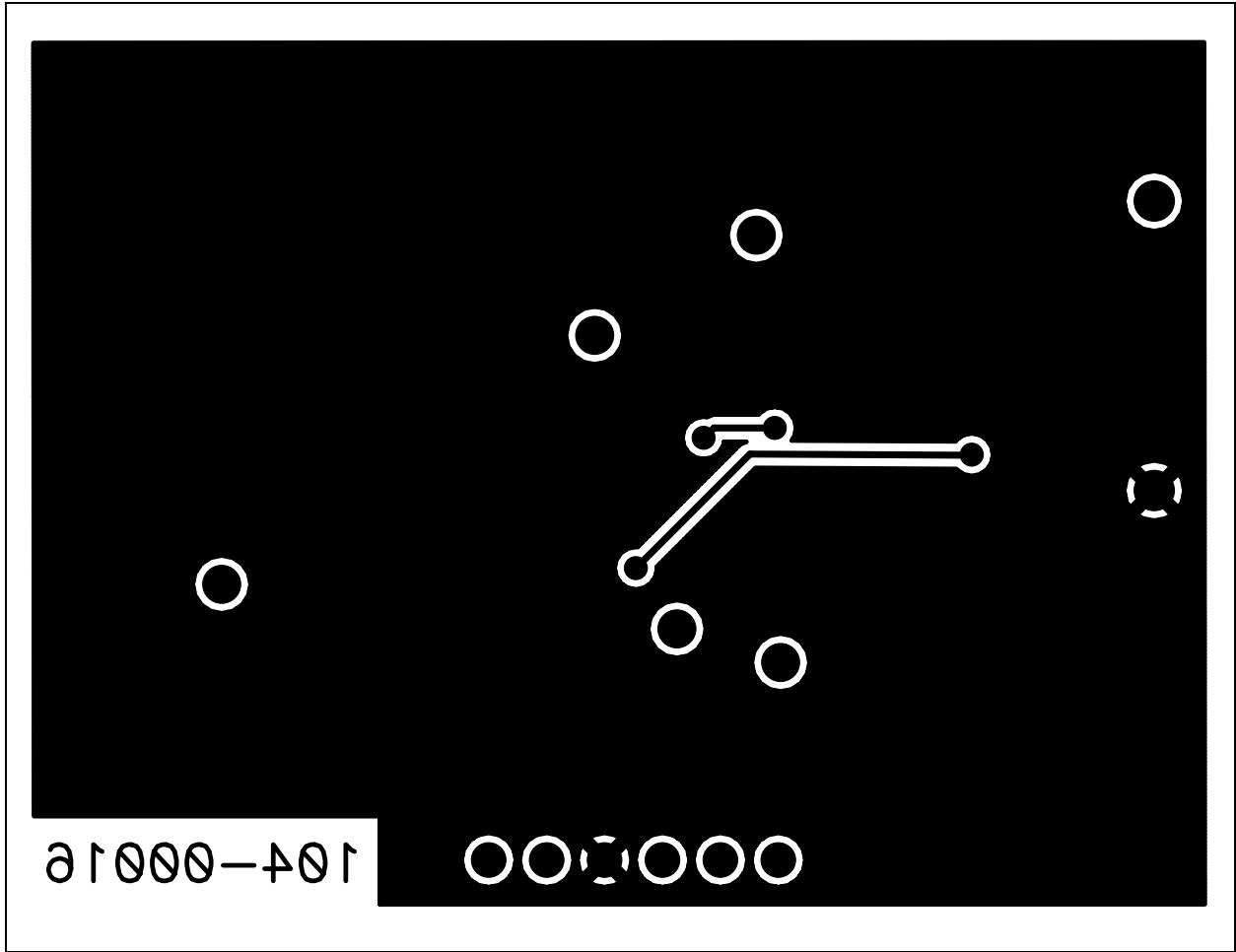

MCP1252 Charge Pump Backlight LED Demo Board User's Guide

NOTES:



MCP1252 CHARGE PUMP BACKLIGHT LED DEMO BOARD USER'S GUIDE

Appendix B. Bill-Of-Materials (BOM)

TABLE B-1: BILL-OF-MATERIALS (BOM)

QTY	Reference	Description	Manufacture	MFG PART #
1	C2	CAP .1UF 25V CERAMIC X7R 0805	Panasonic® – ECG	ECJ-2VB1E104K
1	C3	CAP 1.0UF 10V CERAMIC X7R 0805	Kemet®	C0805C105K8RACTU
2	C4,C5	CAP 10UF 6.3V CERAMIC X5R 1206	Kemet	C1206C106K9PACTU
4	R1,R2,R3,R4	RES 15.0 OHM 1/10W 1% 0805 SMD	Panasonic – ECG	ERJ-6ENF15R0V
1	R5	RES 10.0K OHM 1/10W 1% 0805 SMD	Panasonic – ECG	ERJ-6ENF1002V
2	R7,R12	RES 4.99K OHM 1/10W 1% 0805 SMD	Panasonic – ECG	ERJ-6ENF4991V
3	R6,R8,R10	RES 49.9K OHM 1/10W 1% 0805 SMD	Panasonic – ECG	ERJ-6ENF4992V
1	R11	RES 100K OHM 1/10W 1% 0805 SMD	Panasonic – ECG	ERJ-6ENF1003V
1	R9	RES 1.00M OHM 1/10W 1% 0805 SMD	Panasonic – ECG	ERJ-6ENF1004V
4	D1,D2,D3,D4	LED WHITE DIFFUSED 2-PLCC SMD	Osram Opto Semiconductors Inc	LW T67C-T2U2-3C5D
2	S1,S2	SWITCH LT TOUCH 6X3.5 100GF SMD	Panasonic – ECG	EVQ-PJS04K
1	BAT 1	HOLDER BATTERY 3CELL AAA PC MNT	Keystone Electronics®	2479
1	J1	SIP_6 Pin "Do Not Populate"	—	—
1	JP1	CONN HEADER 2POS .100 VERT TIN	Molex®/Waldom® Electronics Corp	22-28-4021
1	U1	MCP1252	Microchip Technology Inc.	MCP1252-ADJI/MS
1	U2	PIC10F206-E/OTG	Microchip Technology Inc.	PIC10F206-E/OTG

MCP1252 Charge Pump Backlight LED Demo Board User's Guide

NOTES:

Appendix C. 00016R1.asm Source Code

C.1 DEVICE FIRMWARE

Software License Agreement

The software supplied herewith by Microchip Technology Incorporated (the "Company") is intended and supplied to you, the Company's customer, for use solely and exclusively with products manufactured by the Company.

The software is owned by the Company and/or its supplier, and is protected under applicable copyright laws. All rights are reserved. Any use in violation of the foregoing restrictions may subject the user to criminal sanctions under applicable laws, as well as to civil liability for the breach of the terms and conditions of this license.

THIS SOFTWARE IS PROVIDED IN AN "AS IS" CONDITION. NO WARRANTIES, WHETHER EXPRESS, IMPLIED OR STATUTORY, INCLUDING, BUT NOT LIMITED TO, IMPLIED WARRANTIES OF MERCHANTABILITY AND FITNESS FOR A PARTICULAR PURPOSE APPLY TO THIS SOFTWARE. THE COMPANY SHALL NOT, IN ANY CIRCUMSTANCES, BE LIABLE FOR SPECIAL, INCIDENTAL OR CONSEQUENTIAL DAMAGES, FOR ANY REASON WHATSOEVER.

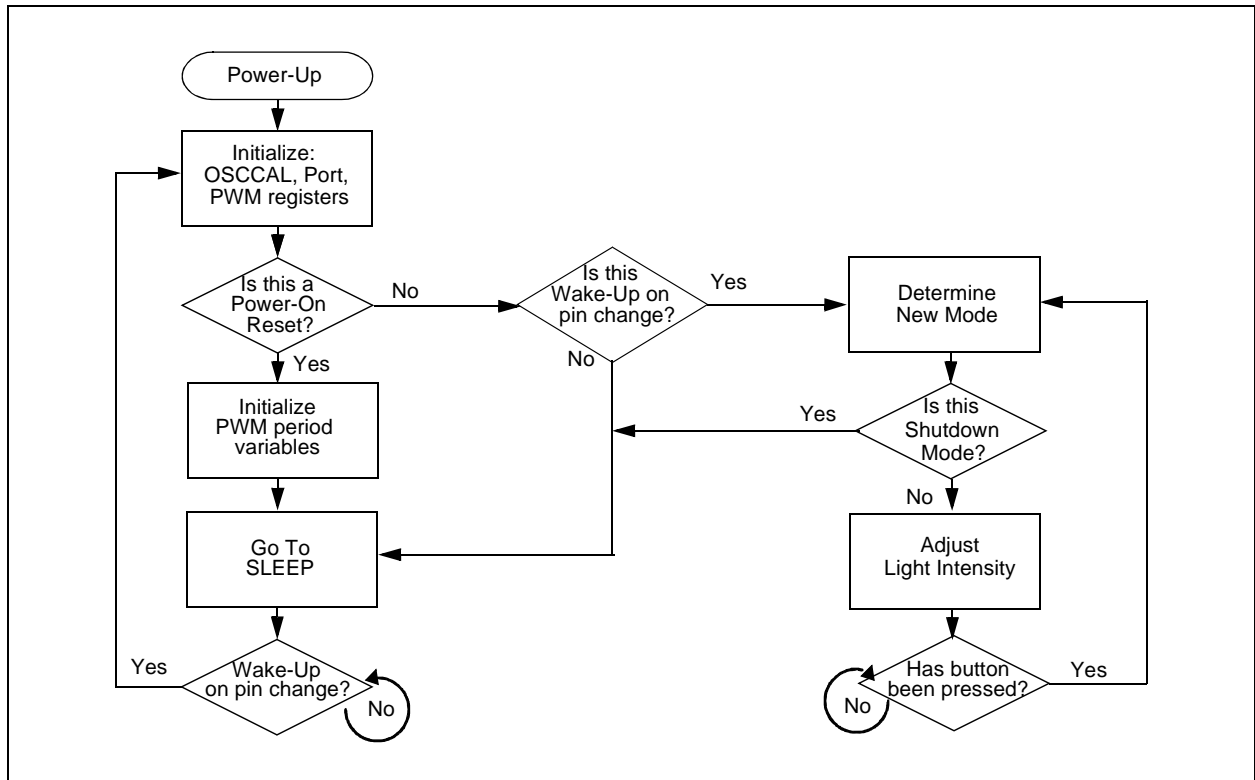

FIGURE C-1: Firmware Flowchart – Page 1.

TABLE C-1: 00016R1.ASM

```

;*****
;
;   Filename:      00016R1.asm
;   Date:         31aug04
;   File Version:  ppl
;
;   Author:      M Waldron
;   Company:    MCHP
;   10f204/ 10f206 PWM to control LED driver
;
;*****
;
;   Files required:
;
;
;
;*****
;
;   Notes: Changed file name, added led_medhi routine,
;          adjusted intensity of various modes.  PB 3/29/05
;
;
;
;*****

list p=10f206          ; list directive to define processor
#include <p10f206.inc>  ; processor specific variable definitions

__CONFIG _CP_OFF & _WDT_OFF & _MCLRE_OFF & _IntrC_OSC

; \_CONFIG' directive is used to embed configuration data within .asm file.
; The labels following the directive are located in the respective .inc file.
; See respective data sheet for additional information on configuration word.

;constants
;increase led_xxx_on to increase intensity ( value must be less than period value)
;increase period to reduce PWM frequency and increase PWM resolution
led_hi_on      = 0x16      ;on loops for high brightness mode
led_hi_off     = 0x11      ;off loops for high brightness mode, value will be calculated
by the program (10)
led_medhi_on   = 0x08      ;on loops for medium_high brightness mode
led_medhi_off  = 0x11      ;off loops for high brightness mode (11)
led_med_on     = 0x06      ;on loops for medium brightness mode
led_med_off    = 0x11      ;off loops for high brightness mode (11)
led_low_on     = 0x05      ;on loops for low brightness mode
led_low_off    = 0x12      ;off loops for high brightness mode (12)
period         = 0x0E      ;total loops per PWM period
max_time       = 0xff      ;on time before unit swithces back to sleep

;variables
mode           = 0x13      ;current mode ( high, med, lo )
counter        = 0x14      ;hi and low time counter
debounce       = 0x15      ;debounce counter
flag           = 0x16      ;debounce control flags

```

TABLE C-1: 00016R1.ASM (CONTINUED)

```

timerh      = 0x17      ;on timer high byte
timerl      = 0x18      ;on timer low byte

;bits used in the flag variable
new_mode    = 7          ;when set a debounced user keypress has been detected
timer_ena   = 6          ;when clear the debounce timer will not increment
;GPIO pins
button      = 3          ;mode select button
pwm         = 0          ;pwm output

;other
TO          EQU         H'0004'
PD          EQU         H'0003'
GPWU       EQU         H'0007'
GPPU       EQU         H'0006'
COUTEN     EQU         H'0006'
CMPTOCS    EQU         H'0004'
CWU        EQU         H'0000'

    org 0x00
                goto reset

    org 0x10

reset        nop
                nop
                bcf OSCCAL, FOSC4      ; GP2/T0CKI/COUT applied to GP2 pin
init_ports  movlw 0x01      ;italize mode, upon wake up led will be at low intensity
                movwf mode
                ;
                movlw b'00001111'      ;configure for wake on port change
OPTION
                ;
                movlw b'01010011'      ;disable the comparator
                movwf 0x07              ;write to CMCON0
                ;
                clrf GPIO
                movlw 0x0E
                tris GPIO              ;configure port
                ;
                bcf STATUS, GPWUF
                btfsc STATUS, CWUF      ;test for wake up or reset
                goto wake
                btfsc STATUS, GPWUF
                goto wake
                btfss STATUS, TO
                goto wake
                btfss STATUS, PD
                goto wake
                goto init_vars          ;initialize vars

init_vars   movlw 0xFF
                movwf timerh
                movwf timerl
                ;
                movlw led_hi_on          ;calculate off times based on time remaining in
PWM period

```

TABLE C-1: 00016R1.ASM (CONTINUED)

	movwf led_hi_off	;add the complement of on time to the window time
	comf led_hi_off, f	
	movlw period	
	addwf led_hi_off, f	
	;	
PWM period	movlw led_medhi_on	;calculate off times based on time remaining in
time	movwf led_medhi_off	;add the complement of on time to the window
	comf led_medhi_off, f	
	movlw period	
	addwf led_medhi_off, f	
	;	
PWM period	movlw led_med_on	;calculate off times based on time remaining in
	movwf led_med_off	;add the complement of on time to the window time
	comf led_med_off, f	
	movlw period	
	addwf led_med_off, f	
	;	
PWM period	movlw led_low_on	;calculate off times based on time remaining in
	movwf led_low_off	;add the complement of on time to the window time
	comf led_low_off, f	
	movlw period	
	addwf led_low_off, f	
	;	
	movf GPIO, w	;read port before entering sleep mode
wake	sleep	
	btfss GPIO, button	;only allow a low to bring PIC out of sleep
	goto inc_mode	
	movlw 0x20	
	call delay	
	movf GPIO, w	
	sleep	
	;	
inc_mode	incf mode, f	;it was a pin change, determine new mode
		;determine current mode
mode_select	bcf flag, new_mode	;clear new mode flag
	;	
	movlw 0x01	
	subwf mode, w	
	btfsc STATUS, Z	
	goto led_off	
	;	
	movlw 0x02	
	subwf mode, w	
	btfsc STATUS, Z	
	goto led_low	
	;	
	movlw 0x03	
	subwf mode, w	
	btfsc STATUS, Z	
	goto led_med	
	;	

TABLE C-1: 00016R1.ASM (CONTINUED)

```

        movlw 0x04
        subwf mode, w
        btfsc STATUS, Z
        goto led_medhi
        ;
        movlw 0x05
        subwf mode, w
        btfsc STATUS, Z
        goto led_high
        ;
        movlw 0x06
        subwf mode, w
        btfsc STATUS, Z
        goto led_full
        ;
        movlw 0x01          ;on mode rollover reset to low brightness mode
        movwf mode
        goto mode_select

        ;full on
led_full  bsf GPIO, pwm
        movlw 0x0F
        call delay          ;used as debounce
        call bounce
        btfss flag, new_mode
        goto led_full
        goto mode_select

        ;high brightness routine
led_high  bsf GPIO, pwm          ;turn on LED(s) for a set time
        movlw led_hi_on
        call delay
        bcf GPIO, pwm          ;turn off LED(s) fo a set time
        movf led_hi_off, w
        call delay
        call bounce
        btfss flag, new_mode
        goto led_high
        goto mode_select
        ;medium-high brightness routine
led_medhi bsf GPIO, pwm          ;turn on LED(s) for a set time
        movlw led_medhi_on
        call delay
        bcf GPIO, pwm          ;turn off LED(s) fo a set time
        movf led_medhi_off, w
        call delay
        call bounce
        btfss flag, new_mode
        goto led_medhi
        goto mode_select
        ;medium brightness routine

```

TABLE C-1: 00016R1.ASM (CONTINUED)

```

led_med    bsf GPIO, pwm          ;turn on LED(s) for a set time
           movlw led_med_on
           call delay
           bcf GPIO, pwm          ;turn off LED(s) fo a set time
           movf led_med_off, w
           call delay
           call bounce
           btfss flag, new_mode
           goto led_med
           goto mode_select

           ;low brightness routine
led_low    bsf GPIO, pwm          ;turn on LED(s) for a set time
           movlw led_low_on
           call delay
           bcf GPIO, pwm          ;turn off LED(s) for a set time
           movf led_low_off, w
           call delay
           call bounce
           btfss flag, new_mode
           goto led_low
           goto mode_select

           ;led off
led_off    movlw 0x20
           call delay
           bcf GPIO, pwm          ;turn off LED(s)
           movf GPIO, w           ;read port before entering sleep mode
           sleep

           ;delay loop for on and off time
delay      movwf counter          ; Delay = (3 + (3 * counter) + 2) Tcy
loop       decfsz counter, f
           goto loop
           retlw 0x00

           ;check for button press
bounce     btfss GPIO, button     ; Is Button Depressed?
           goto bounce1          ; Yes, go to "bounce1"
           bsf flag, timer_ena    ; No, allow timer to start
           clrf debounce         ; no user entry, reset debounce timer
           retlw 0x00           ;

bounce1    btfss flag, timer_ena
           retlw 0x00           ;do not increment as we have not seen the debounce
released yet
           incfsz debounce, f    ;inc debounce timer
           retlw 0x00           ;not yet
           bsf flag, new_mode
           incf mode, f          ;a valid press has been detected
           bcf flag, timer_ena   ;prevent timer from incrementing to prevent
cycling though modes by holding debounce
bounce00   retlw 0x00

end

```

NOTES:



WORLDWIDE SALES AND SERVICE

AMERICAS

Corporate Office
2355 West Chandler Blvd.
Chandler, AZ 85224-6199
Tel: 480-792-7200
Fax: 480-792-7277
Technical Support:
<http://support.microchip.com>
Web Address:
www.microchip.com

Atlanta
Alpharetta, GA
Tel: 770-640-0034
Fax: 770-640-0307

Boston
Westborough, MA
Tel: 774-760-0087
Fax: 774-760-0088

Chicago
Itasca, IL
Tel: 630-285-0071
Fax: 630-285-0075

Dallas
Addison, TX
Tel: 972-818-7423
Fax: 972-818-2924

Detroit
Farmington Hills, MI
Tel: 248-538-2250
Fax: 248-538-2260

Kokomo
Kokomo, IN
Tel: 765-864-8360
Fax: 765-864-8387

Los Angeles
Mission Viejo, CA
Tel: 949-462-9523
Fax: 949-462-9608

San Jose
Mountain View, CA
Tel: 650-215-1444
Fax: 650-961-0286

Toronto
Mississauga, Ontario,
Canada
Tel: 905-673-0699
Fax: 905-673-6509

ASIA/PACIFIC

Australia - Sydney
Tel: 61-2-9868-6733
Fax: 61-2-9868-6755

China - Beijing
Tel: 86-10-8528-2100
Fax: 86-10-8528-2104

China - Chengdu
Tel: 86-28-8676-6200
Fax: 86-28-8676-6599

China - Fuzhou
Tel: 86-591-8750-3506
Fax: 86-591-8750-3521

China - Hong Kong SAR
Tel: 852-2401-1200
Fax: 852-2401-3431

China - Shanghai
Tel: 86-21-5407-5533
Fax: 86-21-5407-5066

China - Shenyang
Tel: 86-24-2334-2829
Fax: 86-24-2334-2393

China - Shenzhen
Tel: 86-755-8203-2660
Fax: 86-755-8203-1760

China - Shunde
Tel: 86-757-2839-5507
Fax: 86-757-2839-5571

China - Qingdao
Tel: 86-532-502-7355
Fax: 86-532-502-7205

ASIA/PACIFIC

India - Bangalore
Tel: 91-80-2229-0061
Fax: 91-80-2229-0062

India - New Delhi
Tel: 91-11-5160-8631
Fax: 91-11-5160-8632

Japan - Kanagawa
Tel: 81-45-471- 6166
Fax: 81-45-471-6122

Korea - Seoul
Tel: 82-2-554-7200
Fax: 82-2-558-5932 or
82-2-558-5934

Malaysia - Penang
Tel: 011-604-646-8870
Fax: 011-604-646-5086

Philippines - Manila
Tel: 011-632-634-9065
Fax: 011-632-634-9069

Singapore
Tel: 65-6334-8870
Fax: 65-6334-8850

Taiwan - Kaohsiung
Tel: 886-7-536-4818
Fax: 886-7-536-4803

Taiwan - Taipei
Tel: 886-2-2500-6610
Fax: 886-2-2508-0102

Taiwan - Hsinchu
Tel: 886-3-572-9526
Fax: 886-3-572-6459

EUROPE

Austria - Weis
Tel: 43-7242-2244-399
Fax: 43-7242-2244-393

Denmark - Ballerup
Tel: 45-4450-2828
Fax: 45-4485-2829

France - Massy
Tel: 33-1-69-53-63-20
Fax: 33-1-69-30-90-79

Germany - Ismaning
Tel: 49-89-627-144-0
Fax: 49-89-627-144-44

Italy - Milan
Tel: 39-0331-742611
Fax: 39-0331-466781

Netherlands - Drunen
Tel: 31-416-690399
Fax: 31-416-690340

England - Berkshire
Tel: 44-118-921-5869
Fax: 44-118-921-5820