

## Ultra-Low-Noise, High PSRR, Low-Dropout, 150mA Linear Regulators in $\mu$ DFN

### General Description

The MAX8840/MAX8841/MAX8842 ultra-low-noise, low-dropout (LDO) linear regulators are designed to deliver up to 150mA continuous output current. These regulators achieve a low 120mV dropout for 120mA load current. The MAX8840 uses an advanced architecture to achieve ultra-low output voltage noise of 11 $\mu$ V<sub>RMS</sub> and PSRR of 54dB at 100kHz.

The MAX8841 does not require a bypass capacitor, hence achieving the smallest PC board area. The MAX8842 output voltage can be adjusted with an external divider.

The MAX8840/MAX8841 are preset to a variety of voltages in the 1.5V to 4.5V range. Designed with a p-channel MOSFET series pass transistor, the MAX8840/MAX8841/MAX8842 maintain very low ground current (40 $\mu$ A).

The regulators are designed and optimized to work with low-value, low-cost ceramic capacitors. The MAX8840 requires only 1 $\mu$ F (typ) of output capacitance for stability with any load. When disabled, current consumption drops to below 1 $\mu$ A.

The MAX8840/MAX8841/MAX8842 are available in a tiny 1.0mm x 1.5mm x 0.8mm  $\mu$ DFN.

### Applications

Cellular and Cordless Phones  
 PDA and Palmtop Computers  
 Base Stations  
 Bluetooth Portable Radios and Accessories  
 Wireless LANs  
 Digital Cameras  
 Personal Stereos  
 Portable and Battery-Powered Equipment

### Typical Operating Circuits

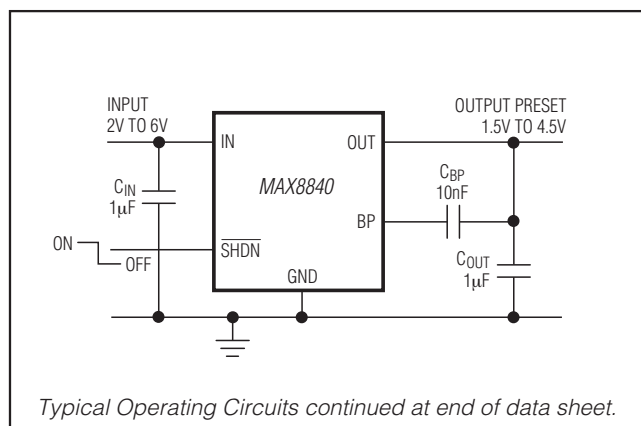

### Features

- ◆ Space-Saving 1.0mm x 1.5mm x 0.8mm  $\mu$ DFN
- ◆ 11 $\mu$ V<sub>RMS</sub> Output Noise at 100Hz to 100kHz Bandwidth (MAX8840)
- ◆ 78dB PSRR at 1kHz (MAX8840)
- ◆ 120mV Dropout at 120mA Load
- ◆ Stable with 1 $\mu$ F Ceramic Capacitor for Any Load
- ◆ Guaranteed 150mA Output
- ◆ Only Need Input and Output Capacitors (MAX8841)
- ◆ Output Voltages: 1.5V, 1.8V, 2.5V, 2.6V, 2.7V, 2.8V, 2.85V, 3V, 3.3V, 4.5V (MAX8840/MAX8841) and Adjustable (MAX8842)
- ◆ Low 40 $\mu$ A Ground Current
- ◆ Excellent Load/Line Transient
- ◆ Overcurrent and Thermal Protection

### Ordering Information

PART*	TEMP RANGE	PIN-PACKAGE
MAX8840ELTxxy+T	-40°C to +85°C	6 $\mu$ DFN-6 1.5mm x 1.0mm
MAX8841ELTxxy+T	-40°C to +85°C	6 $\mu$ DFN-6 1.5mm x 1.0mm
MAX8842ELT+T	-40°C to +85°C	6 $\mu$ DFN-6 1.5mm x 1.0mm

\*xy is the output voltage code (see the Output Voltage Selector Guide). Other versions between 1.5V and 4.5V are available in 100mV increments. Contact factory for other versions.

+Denotes lead-free package.

Output Voltage Selector Guide appears at end of data sheet.

### Pin Configuration

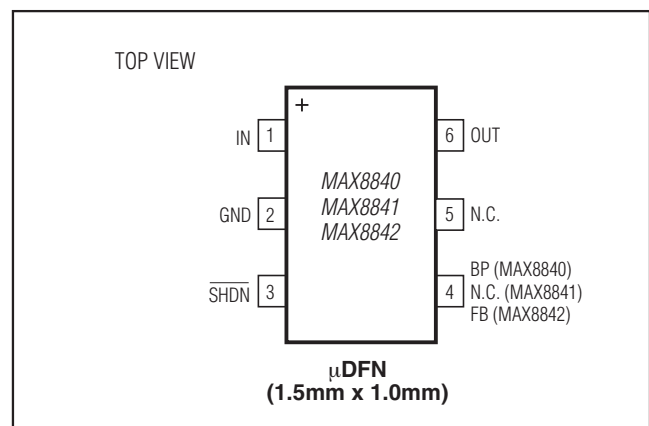

# MAX8840/MAX8841/MAX8842

## Ultra-Low-Noise, High PSRR, Low-Dropout, 150mA Linear Regulators in $\mu$ DFN

### ABSOLUTE MAXIMUM RATINGS

IN to GND .....-0.3V to +7V  
 Output Short-Circuit Duration ..... Infinite  
 OUT, SHDN to GND .....-0.3V to (IN + 0.3V)  
 FB, BP, N.C. to GND.....-0.3V to (OUT + 0.3V)  
 Continuous Power Dissipation ( $T_A = +70^\circ\text{C}$ )  
 6-Pin  $\mu$ DFN (derate 2.1mW/ $^\circ\text{C}$  above +70 $^\circ\text{C}$ ) .....0.168W

$\theta_{JA}$  .....477 $^\circ\text{C}/\text{W}$   
 Operating Temperature Range .....-40 $^\circ\text{C}$  to +85 $^\circ\text{C}$   
 Junction Temperature .....+150 $^\circ\text{C}$   
 Storage Temperature Range .....-65 $^\circ\text{C}$  to +150 $^\circ\text{C}$   
 Lead Temperature (soldering, 10s) .....+300 $^\circ\text{C}$

Stresses beyond those listed under "Absolute Maximum Ratings" may cause permanent damage to the device. These are stress ratings only, and functional operation of the device at these or any other conditions beyond those indicated in the operational sections of the specifications is not implied. Exposure to absolute maximum rating conditions for extended periods may affect device reliability.

### ELECTRICAL CHARACTERISTICS

( $V_{IN} = V_{OUT} + 0.5\text{V}$ ,  $T_A = -40^\circ\text{C}$  to +85 $^\circ\text{C}$ , unless otherwise noted.  $C_{IN} = 1\mu\text{F}$ ,  $C_{OUT} = 1\mu\text{F}$ ,  $C_{BP} = 10\text{nF}$ . Typical values are at +25 $^\circ\text{C}$ ; the MAX8842 is tested with 2.45V output, unless otherwise noted.) (Note 1)

PARAMETER	SYMBOL	CONDITIONS	MIN	TYP	MAX	UNITS
Input Voltage Range	$V_{IN}$		2		6	V
Output Voltage Accuracy		$I_{OUT} = 1\text{mA}$ , $T_A = +25^\circ\text{C}$	-1		+1	%
		$I_{OUT} = 100\mu\text{A}$ to 80mA, $T_A = +25^\circ\text{C}$	-2		+2	
		$I_{OUT} = 100\mu\text{A}$ to 80mA	-3		+3	
Maximum Output Current	$I_{OUT}$		150			mA
Current Limit	$I_{LIM}$	OUT = 90% of nominal value	150	200	300	mA
Dropout Voltage (Note 2)		$V_{OUT} \geq 3\text{V}$ , $I_{OUT} = 80\text{mA}$		80	170	mV
		$V_{OUT} \geq 3\text{V}$ , $I_{OUT} = 120\text{mA}$		120		
		$2.5\text{V} \leq V_{OUT} < 3\text{V}$ , $I_{OUT} = 80\text{mA}$		90	200	
		$2.5\text{V} \leq V_{OUT} < 3\text{V}$ , $I_{OUT} = 120\text{mA}$		135		
		$2\text{V} \leq V_{OUT} < 2.5\text{V}$ , $I_{OUT} = 80\text{mA}$		120	250	
		$2\text{V} \leq V_{OUT} < 2.5\text{V}$ , $I_{OUT} = 120\text{mA}$		180		
Ground Current	$I_Q$	$I_{OUT} = 0.05\text{mA}$		40	90	$\mu\text{A}$
		$V_{IN} = V_{OUT(nom)} - 0.1\text{V}$ , $I_{OUT} = 0\text{mA}$		220	500	
Line Regulation	$V_{LNR}$	$V_{IN} = (V_{OUT} + 0.5\text{V})$ to 6V, $I_{OUT} = 0.1\text{mA}$		0.001		%/V
Load Regulation	$V_{LDR}$	$I_{OUT} = 1\text{mA}$ to 80mA		0.003		%/mA
Shutdown Supply Current	$I_{SHDN}$	$\overline{\text{SHDN}} = 0\text{V}$	$T_A = +25^\circ\text{C}$	0.003	1	$\mu\text{A}$
			$T_A = +85^\circ\text{C}$		0.05	
Ripple Rejection	PSRR	$f = 1\text{kHz}$ , $I_{OUT} = 10\text{mA}$	MAX8840		78	dB
			MAX8841/MAX8842		72	
		$f = 10\text{kHz}$ , $I_{OUT} = 10\text{mA}$	MAX8840		75	
			MAX8841/MAX8842		65	
		$f = 100\text{kHz}$ , $I_{OUT} = 10\text{mA}$	MAX8840		54	
			MAX8841/ MAX8842		46	

# MAX8840/MAX8841/MAX8842

## Ultra-Low-Noise, High PSRR, Low-Dropout, 150mA Linear Regulators in $\mu$ DFN

### ELECTRICAL CHARACTERISTICS (continued)

( $V_{IN} = V_{OUT} + 0.5V$ ,  $T_A = -40^\circ C$  to  $+85^\circ C$ , unless otherwise noted.  $C_{IN} = 1\mu F$ ,  $C_{OUT} = 1\mu F$ ,  $C_{BP} = 10nF$ . Typical values are at  $+25^\circ C$ ; the MAX8842 is tested with 2.45V output, unless otherwise noted.) (Note 1)

PARAMETER	SYMBOL	CONDITIONS	MIN	TYP	MAX	UNITS
Output Noise Voltage (RMS)		f = 100Hz to 100kHz, $I_{LOAD} = 10mA$	MAX8840	11		$\mu V$
			MAX8841/MAX8842	230		
		f = 100Hz to 100kHz, $I_{LOAD} = 80mA$	MAX8840	13		
			MAX8841/MAX8842	230		
Shutdown Exit Delay		$R_{LOAD} = 50\Omega$ (Note 3)			300	$\mu s$
$\overline{SHDN}$ Logic-Low Level		$V_{IN} = 2V$ to $6V$			0.4	V
$\overline{SHDN}$ Logic-High Level		$V_{IN} = 2V$ to $6V$	1.5			V
$\overline{SHDN}$ Input Bias Current		$V_{IN} = 6V$ , $\overline{SHDN} = 0V$ or $6V$	$T_A = +25^\circ C$			$\mu A$
			$T_A = +85^\circ C$	0.01		
FB Input Bias Current (MAX8842)		$V_{IN} = 6V$ , $V_{FB} = 1.3V$	$T_A = +25^\circ C$	0.006	0.1	$\mu A$
			$T_A = +85^\circ C$	0.01		
Thermal Shutdown				160		$^\circ C$
Thermal-Shutdown Hysteresis				10		$^\circ C$

**Note 1:** Limits are 100% tested at  $+25^\circ C$ . Limits over operating temperature range are guaranteed by design.

**Note 2:** Dropout is defined as  $V_{IN} - V_{OUT}$  when  $V_{OUT}$  is 100mV below the value of  $V_{OUT}$  for  $V_{IN} = V_{OUT} + 0.5V$ .

**Note 3:** Time needed for  $V_{OUT}$  to reach 90% of final value.

### Typical Operating Characteristics

( $V_{IN} = V_{OUT} + 0.5V$ ,  $C_{IN} = 1\mu F$ ,  $C_{OUT} = 1\mu F$ ,  $C_{BP} = 10nF$ ,  $T_A = +25^\circ C$ , unless otherwise noted.)

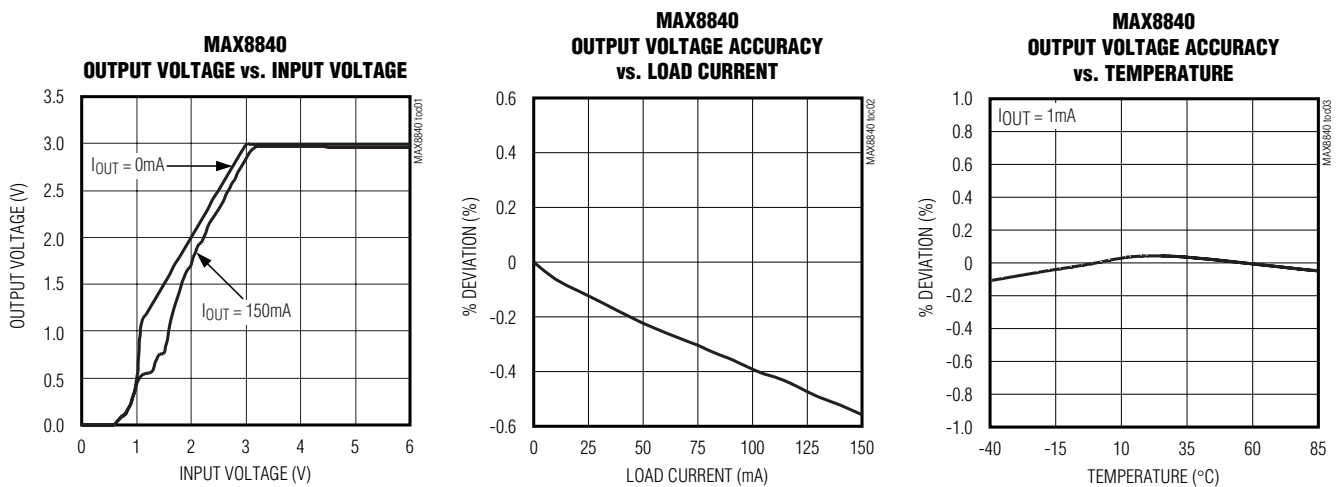

# MAX8840/MAX8841/MAX8842

## Ultra-Low-Noise, High PSRR, Low-Dropout, 150mA Linear Regulators in $\mu$ DFN

### Typical Operating Characteristics (continued)

( $V_{IN} = V_{OUT} + 0.5V$ ,  $C_{IN} = 1\mu F$ ,  $C_{OUT} = 1\mu F$ ,  $C_{BP} = 10nF$ ,  $T_A = +25^\circ C$ , unless otherwise noted.)

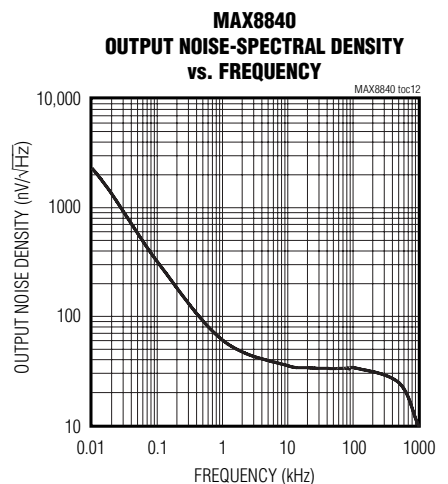
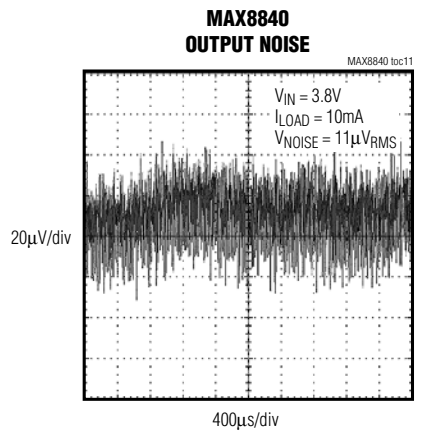
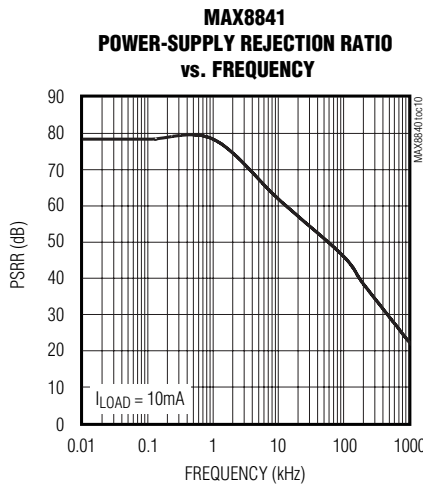
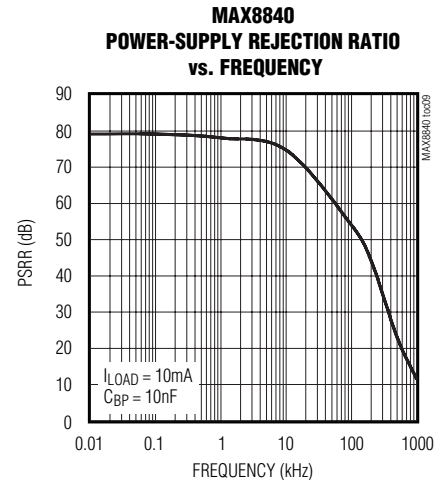
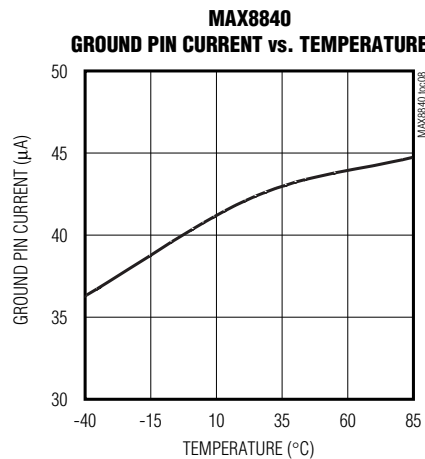
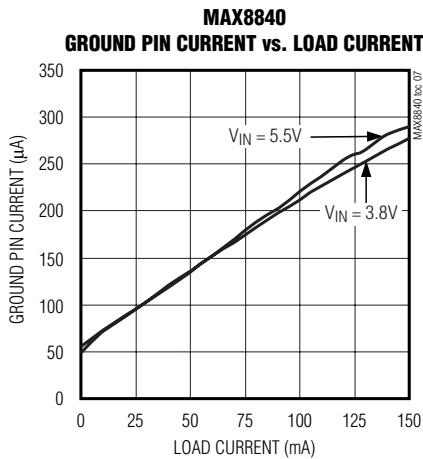
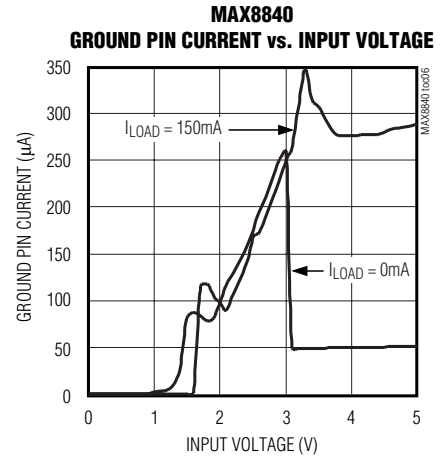
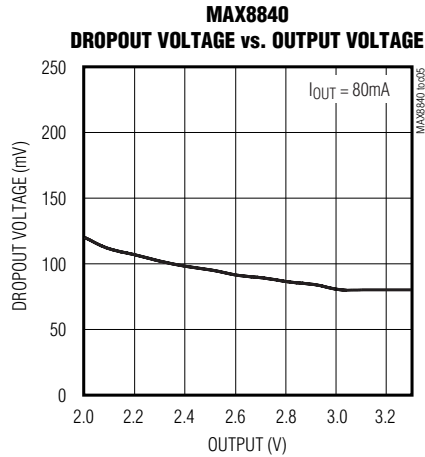
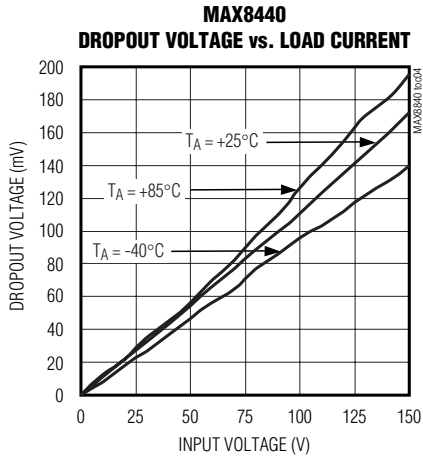

# MAX8840/MAX8841/MAX8842

## Ultra-Low-Noise, High PSRR, Low-Dropout, 150mA Linear Regulators in $\mu$ DFN

### Typical Operating Characteristics (continued)

( $V_{IN} = V_{OUT} + 0.5V$ ,  $C_{IN} = 1\mu F$ ,  $C_{OUT} = 1\mu F$ ,  $C_{BP} = 10nF$ ,  $T_A = +25^\circ C$ , unless otherwise noted.)

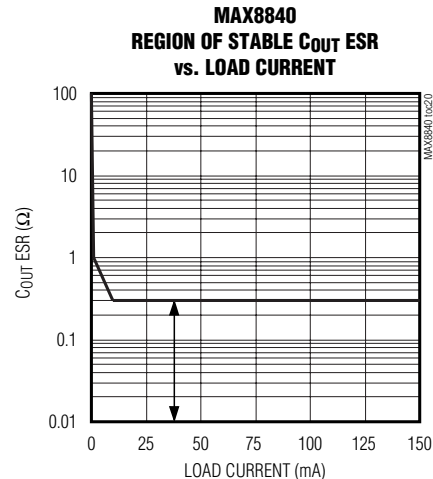
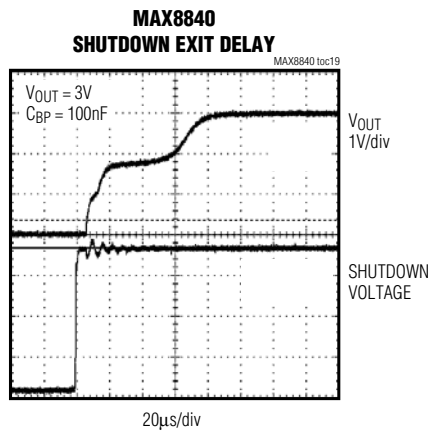
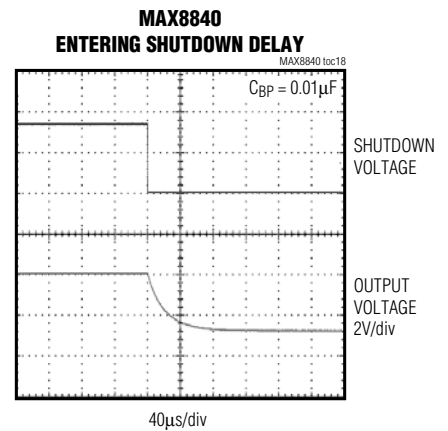
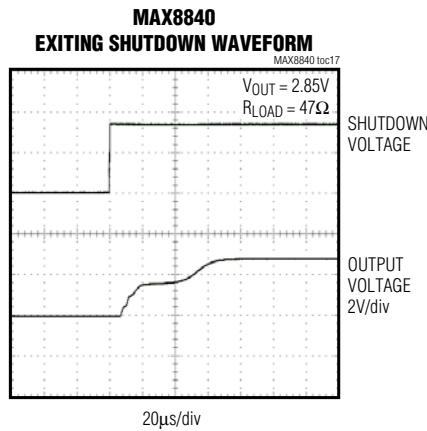
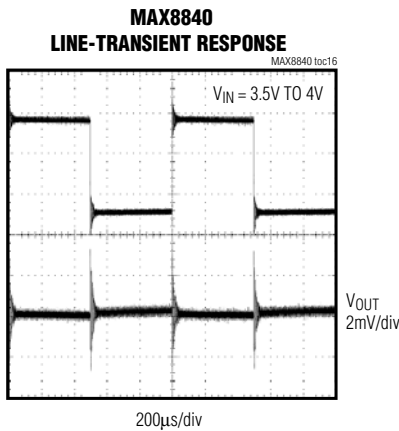
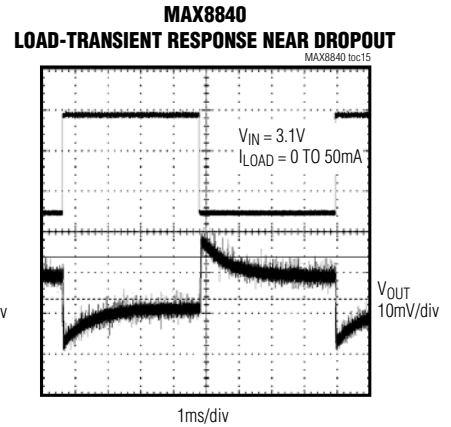
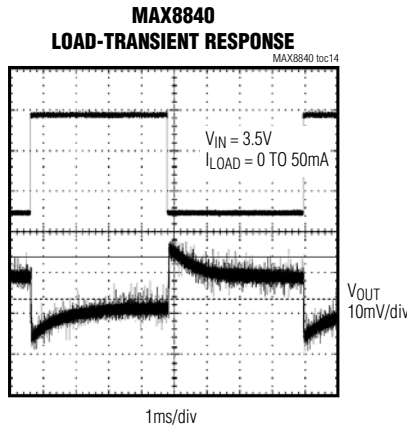
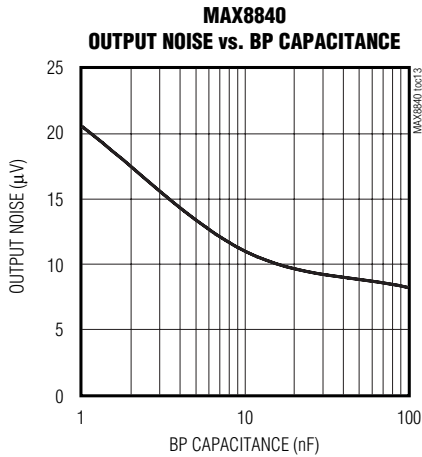

# MAX8840/MAX8841/MAX8842

## Ultra-Low-Noise, High PSRR, Low-Dropout, 150mA Linear Regulators in $\mu$ DFN

### Pin Description

PIN			NAME	FUNCTION
MAX8840	MAX8841	MAX8842		
1	1	1	IN	Unregulated Input Supply
2	2	2	GND	Ground
3	3	3	$\overline{\text{SHDN}}$	Shutdown. Pull low to disable the regulator.
4	—	—	BP	Noise Bypass for Low-Noise Operation. Connect a 10nF capacitor from BP to OUT. It is shorted to OUT in shutdown mode.
—	—	4	FB	Adjustable Output Feedback Point
5	4, 5	5	N.C.	No Connection. Not internally connected.
6	6	6	OUT	Regulated Output Voltage. Bypass with a capacitor to GND. See the <i>Capacitor Selection and Regulator Stability</i> section.

### Detailed Description

The MAX8840/MAX8841/MAX8842 are ultra-low-noise, low-dropout, low-quiescent current linear regulators designed for space-restricted applications. The parts are available with preset output voltages ranging from 1.5V to 4.5V. These devices can supply loads up to 150mA. As shown in the *Functional Diagram*, the MAX8840/MAX8841 consist of an innovative bandgap core and noise bypass circuit, error amplifier, p-channel pass transistor, and internal feedback voltage-divider. The MAX8842 allows for adjustable output with an external feedback network.

The 1.225V bandgap reference is connected to the error amplifier's inverting input. The error amplifier compares this reference with the feedback voltage and amplifies the difference. If the feedback voltage is lower than the reference voltage, the pass-transistor gate is pulled low. This allows more current to pass to the output and increases the output voltage. If the feedback voltage is too high, the pass transistor gate is pulled high, allowing less current to pass to the output. The output voltage is fed back through an internal resistor voltage-divider connected to the OUT pin.

An external bypass capacitor connected to BP (MAX8840) reduces noise at the output. Additional blocks include a current limiter, thermal sensor, and shutdown logic.

#### Internal p-Channel Pass Transistor

The MAX8840/MAX8841/MAX8842 feature a 1 $\Omega$  (typ) p-channel MOSFET pass transistor. This provides several advantages over similar designs using a pnp pass transistor, including longer battery life. The p-channel MOSFET requires no base drive, which considerably

reduces quiescent current. pnp-based regulators waste considerable current in dropout when the pass transistor saturates. They also use high base-drive current under heavy loads. The MAX8840/MAX8841/MAX8842 do not suffer from these problems and consume only 40 $\mu$ A of quiescent current in light load and 220 $\mu$ A in dropout (see the *Typical Operating Characteristics*).

#### Output Voltage Selection

The MAX8840/MAX8841 are supplied with factory-set output voltages from 1.5V to 4.5V, in 100mV increments (see the *Ordering Information*). The MAX8842 features a user-adjustable output through an external feedback network (see the *Typical Operating Circuits*).

To set the output of the MAX8842, use the following equation:

$$R1 = R2 \times \left( \frac{V_{OUT}}{V_{REF}} - 1 \right)$$

where R2 is chosen to be less than 240k $\Omega$  and VREF = 1.225V. Use 1% or better resistors.

#### Shutdown

The MAX8840/MAX8841/MAX8842 feature a low-power shutdown mode that reduces quiescent current less than 1 $\mu$ A. Driving SHDN low disables the voltage reference, error amplifier, gate-drive circuitry, and pass transistor (see the *Functional Diagram*), and the device output enters a high-impedance state. Connect  $\overline{\text{SHDN}}$  to IN for normal operation.

#### Current Limit

The MAX8840/MAX8841/MAX8842 include a current limiter, which monitors and controls the pass transistor's gate voltage, limiting the output current to 200mA.

# MAX8840/MAX8841/MAX8842

## Ultra-Low-Noise, High PSRR, Low-Dropout, 150mA Linear Regulators in $\mu$ DFN

For design purposes, consider the current limit to be 150mA (min) to 300mA (max). The output can be shorted to ground for an indefinite amount of time without damaging the part.

### Thermal-Overload Protection

Thermal-overload protection limits total power dissipation in the MAX8840/MAX8841/MAX8842. When the junction temperature exceeds  $T_J = +160^\circ\text{C}$ , the thermal sensor signals the shutdown logic, turning off the pass transistor and allowing the IC to cool down. The thermal sensor turns the pass transistor on again after the IC's junction temperature drops by  $10^\circ\text{C}$ , resulting in a pulsed output during continuous thermal-overload conditions.

Thermal-overload protection is designed to protect the MAX8840/MAX8841/MAX8842 in the event of a fault condition. For continual operation, do not exceed the absolute maximum junction temperature rating of  $T_J = +150^\circ\text{C}$ .

### Operating Region and Power Dissipation

The MAX8840/MAX8841/MAX8842 maximum power dissipation depends on the thermal resistance of the case and circuit board, the temperature difference between the die junction and ambient, and the rate of airflow. The power dissipation across the device is:

$$P = I_{OUT} (V_{IN} - V_{OUT})$$

The maximum power dissipation is:

$$P_{MAX} = (T_J - T_A) / (\theta_{JC} + \theta_{CA})$$

where  $T_J - T_A$  is the temperature difference between the MAX8840/MAX8841/MAX8842 die junction and the surrounding air,  $\theta_{JC}$  is the thermal resistance of the package, and  $\theta_{CA}$  is the thermal resistance through the PC board, copper traces, and other materials to the surrounding air.

The GND pin of the MAX8840/MAX8841/MAX8842 performs the dual function of providing an electrical connection to ground and channeling heat away. Connect the GND pin to ground using a large pad or ground plane.

### Noise Reduction

For the MAX8840, an external  $0.01\mu\text{F}$  bypass capacitor between BP and OUT with an innovative noise bypass scheme reduces output noises dramatically, exhibiting  $11\mu\text{V}_{RMS}$  of output voltage noise with  $C_{BP} = 0.01\mu\text{F}$  and  $C_{OUT} = 1\mu\text{F}$ . Startup time is minimized by a power-on circuit that precharges the bypass capacitor.

## Applications Information

### Capacitor Selection and Regulator Stability

Use a  $1\mu\text{F}$  capacitor on the MAX8840/MAX8841/MAX8842 input and a  $1\mu\text{F}$  capacitor on the output. Larger input capacitor values and lower ESRs provide better noise rejection and line-transient response. Reduce output noise and improve load-transient response, stability, and power-supply rejection by using large output capacitors. Note that some ceramic dielectrics exhibit large capacitance and ESR variation with temperature. With dielectrics such as Z5U and Y5V, it may be necessary to use a  $2.2\mu\text{F}$  or larger output capacitor to ensure stability at temperatures below  $-10^\circ\text{C}$ . With X7R or X5R dielectrics,  $1\mu\text{F}$  is sufficient at all operating temperatures. A graph of the Region of Stable  $C_{OUT}$  ESR vs. Load Current is shown in the *Typical Operating Characteristics*.

Use a  $0.01\mu\text{F}$  bypass capacitor at BP (MAX8840) for low-output voltage noise. The leakage current going into the BP pin should be less than  $10\text{nA}$ . Increasing the capacitance slightly decreases the output noise. Values above  $0.1\mu\text{F}$  and below  $0.001\mu\text{F}$  are not recommended.

### Noise, PSRR, and Transient Response

The MAX8840/MAX8841/MAX8842 are designed to deliver ultra-low noise and high PSRR, as well as low dropout and low quiescent currents in battery-powered systems. The MAX8840 power-supply rejection is  $78\text{dB}$  at  $1\text{kHz}$  and  $54\text{dB}$  at  $100\text{kHz}$ . The MAX8841/MAX8842 PSRR is  $72\text{dB}$  at  $1\text{kHz}$  and  $46\text{dB}$  at  $100\text{kHz}$  (see the Power-Supply Rejection Ratio vs. Frequency graph in the *Typical Operating Characteristics*).

When operating from sources other than batteries, improved supply-noise rejection and transient response can be achieved by increasing the values of the input and output bypass capacitors, and through passive filtering techniques. The *Typical Operating Characteristics* show the MAX8840/MAX8841/MAX8842 line- and load-transient responses.

### Dropout Voltage

A regulator's minimum dropout voltage determines the lowest usable supply voltage. In battery-powered systems, this determines the useful end-of-life battery voltage. Because the MAX8840/MAX8841/MAX8842 use a p-channel MOSFET pass transistor, their dropout voltage is a function of drain-to-source on-resistance ( $R_{DS(ON)}$ ) multiplied by the load current (see the *Typical Operating Characteristics*).

# MAX8840/MAX8841/MAX8842

## Ultra-Low-Noise, High PSRR, Low-Dropout, 150mA Linear Regulators in $\mu$ DFN

### Functional Diagram

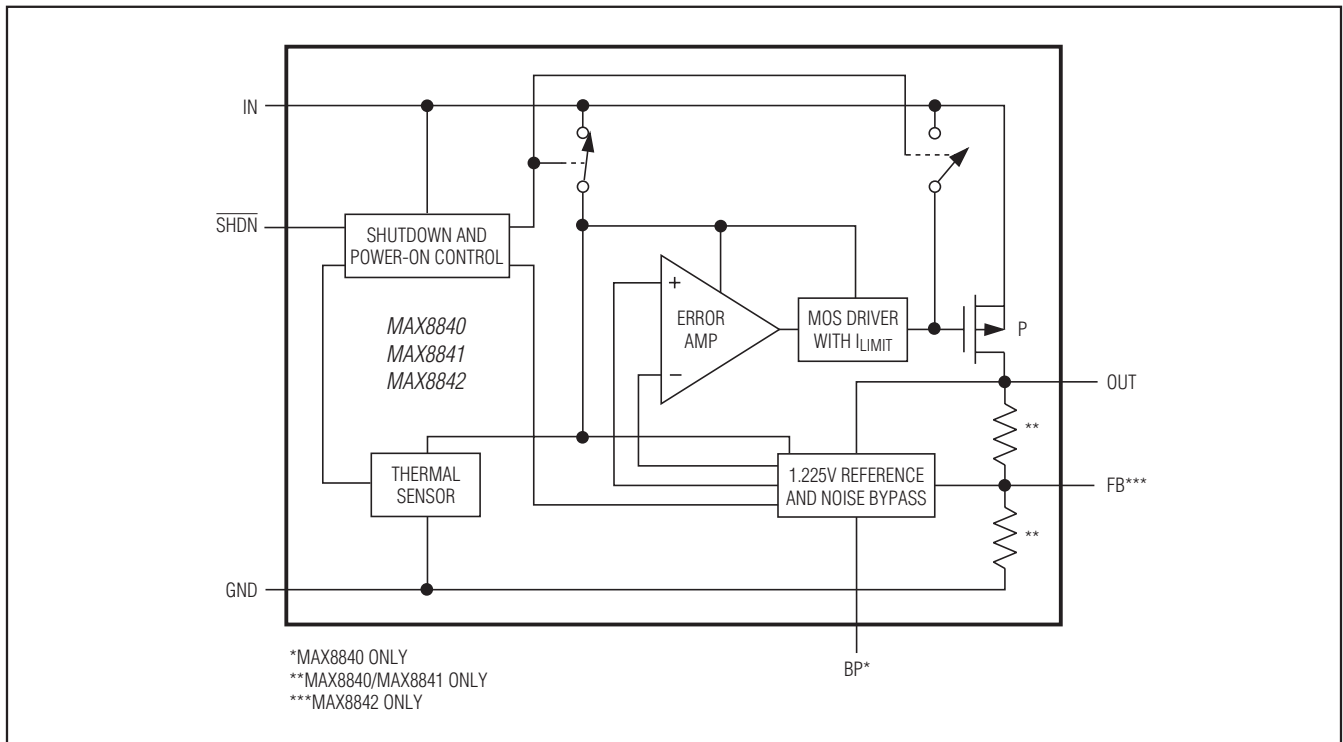



# MAX8840/MAX8841/MAX8842

## Ultra-Low-Noise, High PSRR, Low-Dropout, 150mA Linear Regulators in $\mu$ DFN

### Typical Operating Circuits (continued)

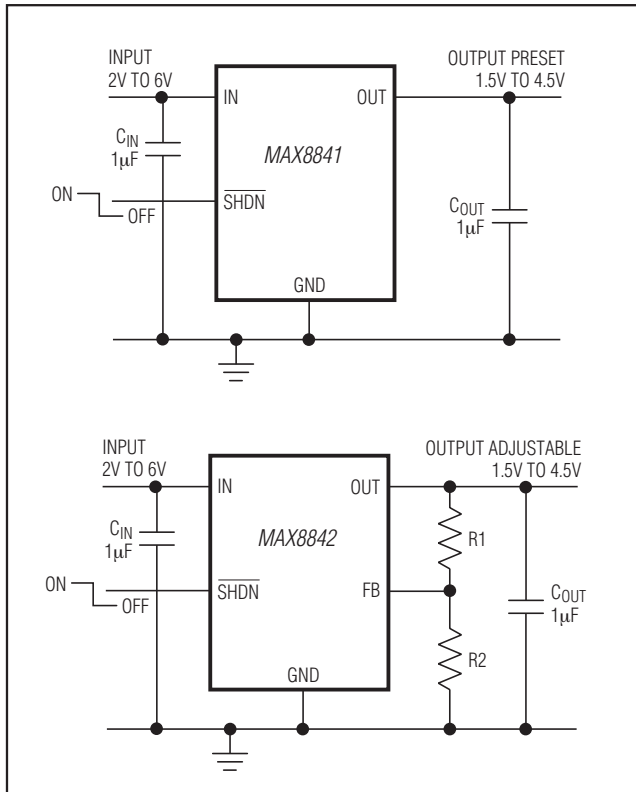

### Output Voltage Selector Guide

PART	V <sub>OUT</sub> (V)	TOPMARK
MAX8840ELT16+T	1.6	<b>MN</b>
MAX8840ELT18+T	1.8	<b>MO</b>
MAX8840ELT19+T	1.9	<b>LX</b>
MAX8840ELT25+T	2.5	<b>MP</b>
MAX8840ELT26+T	2.6	<b>MK</b>
MAX8840ELT27+T	2.7	<b>LU</b>
MAX8840ELT28+T	2.8	<b>LV</b>
MAX8840ELT29+T	2.85	<b>LW</b>
MAX8840ELT30+T	3	<b>LZ</b>
MAX8840ELT31+T	3.1	<b>ML</b>
MAX8840ELT33+T	3.3	<b>MM</b>
MAX8841ELT15+T	1.5	<b>MQ</b>
MAX8841ELT18+T	1.8	<b>MR</b>
MAX8841ELT25+T	2.5	<b>MS</b>
MAX8841ELT26+T	2.6	<b>MT</b>
MAX8841ELT28+T	2.8	<b>MU</b>
MAX8841ELT29+T	2.85	<b>MV</b>
MAX8841ELT89+T	2.9	<b>MW</b>
MAX8841ELT31+T	3.1	<b>MX</b>
MAX8841ELT33+T	3.3	<b>MY</b>
MAX8841ELT45+T	4.5	<b>MZ</b>
MAX8842ELT+T	Adjustable	<b>NA</b>

(Note: Standard output voltage options, shown in **bold**, are available. Contact the factory for other output voltages between 1.5V and 4.5V. Minimum order quantity is 15,000 units.)

### Chip Information

TRANSISTOR COUNT: 284

PROCESS: BiCMOS

### Revision History

Pages changed at Rev 1: 1

# MAX8840/MAX8841/MAX8842

## Ultra-Low-Noise, High PSRR, Low-Dropout, 150mA Linear Regulators in $\mu$ DFN

### Package Information

For the latest package outline information and land patterns (footprints), go to [www.maximintegrated.com/packages](http://www.maximintegrated.com/packages). Note that a "+", "#", or "-" in the package code indicates RoHS status only. Package drawings may show a different suffix character, but the drawing pertains to the package regardless of RoHS status.

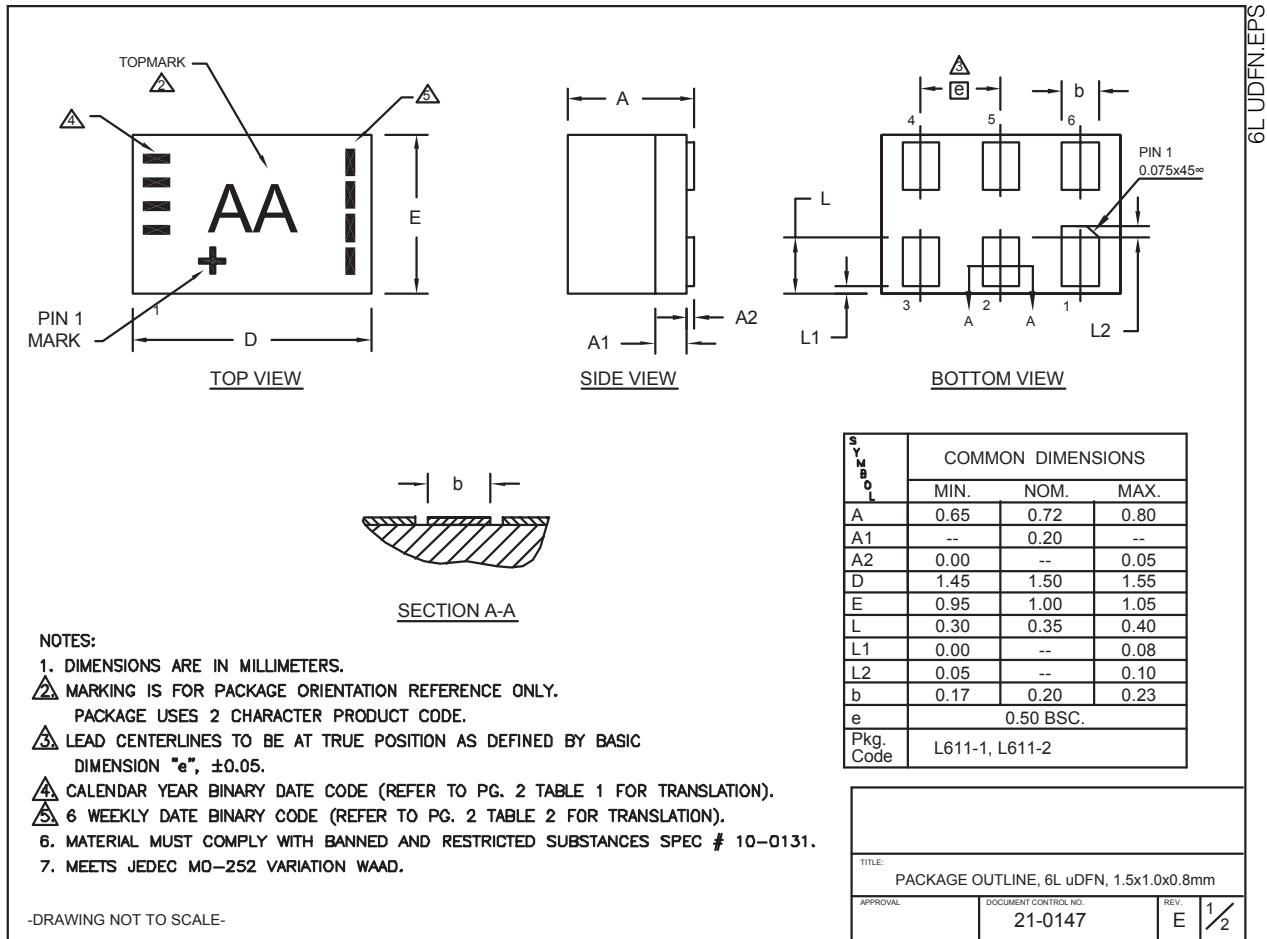

# MAX8840/MAX8841/MAX8842

## Ultra-Low-Noise, High PSRR, Low-Dropout, 150mA Linear Regulators in $\mu$ DFN

### Package Information (continued)

For the latest package outline information and land patterns (footprints), go to [www.maximintegrated.com/packages](http://www.maximintegrated.com/packages). Note that a "+", "#", or "-" in the package code indicates RoHS status only. Package drawings may show a different suffix character, but the drawing pertains to the package regardless of RoHS status.

**TABLE 1** Translation Table for Calendar Year Code

Calendar Year	2005	2006	2007	2008	2009	2010	2011	2012	2013	2014

Legend: Marked with bar    Blank space - no bar required

**TABLE 2** Translation Table for Payweek Binary Coding

Payweek	06-11	12-17	18-23	24-29	30-35	36-41	42-47	48-51	52-05

Legend: Marked with bar    Blank space - no bar required

TITLE:			
PACKAGE OUTLINE, 6L $\mu$ DFN, 1.5x1.0x0.8mm			
APPROVAL	DOCUMENT CONTROL NO.	REV.	
	21-0147	E	2/2

-DRAWING NOT TO SCALE-



Maxim Integrated cannot assume responsibility for use of any circuitry other than circuitry entirely embodied in a Maxim Integrated product. No circuit patent licenses are implied. Maxim Integrated reserves the right to change the circuitry and specifications without notice at any time. The parametric values (min and max limits) shown in the Electrical Characteristics table are guaranteed. Other parametric values quoted in this data sheet are provided for guidance.

**Maxim Integrated 160 Rio Robles, San Jose, CA 95134 USA 1-408-601-1000**