

256K (32K x 8) Static RAM

Features

- **Fast access time: 12 ns**
- **Wide voltage range: 5.0V ± 10% (4.5V to 5.5V)**
- **CMOS for optimum speed/power**
- **TTL-compatible Inputs and Outputs**
- **2.0V Data Retention**
- **Low CMOS standby power**
- **Automated Power-down when deselected**
- **Available in Pb-free and non Pb-free 28-pin (300-Mil) Molded SOJ, 28-pin (300-Mil) DIP and 28-pin TSOP I packages**

General Description

The CY7C199C is a high-performance CMOS Asynchronous SRAM organized as 32K by 8 bits that supports an asynchronous memory interface. The device features an automatic power-down feature that significantly reduces power consumption when deselected.

See the Truth Table in this data sheet for a complete description of read and write modes

Logic Block Diagram

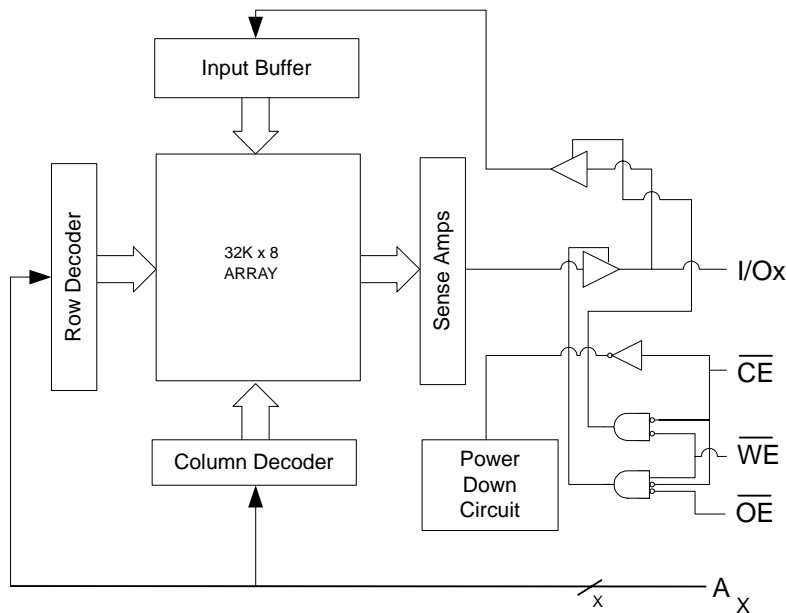

Product Portfolio

	12 ns	15 ns	20 ns	Unit
Maximum Access Time	12	15	20	ns
Maximum Operating Current	85	80	75	mA
Maximum CMOS Standby Current (L)		500		μA

Note:

1. For best-practices recommendations, please refer to the Cypress application note *System Design Guidelines* on www.cypress.com.

Pin Layout and Specifications

28 DIP (6.9 x 35.6 x 3.5 mm)

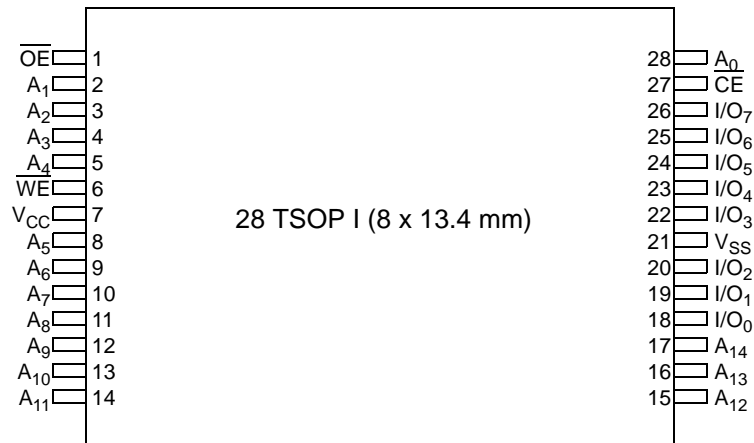
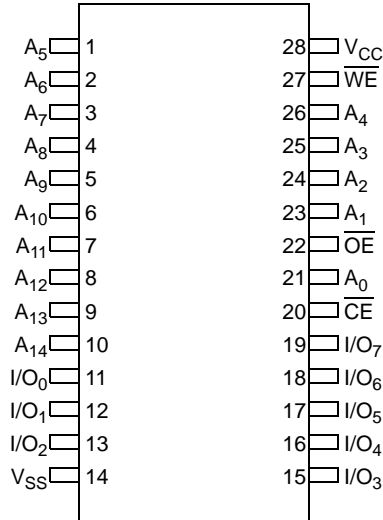

28 SOJ

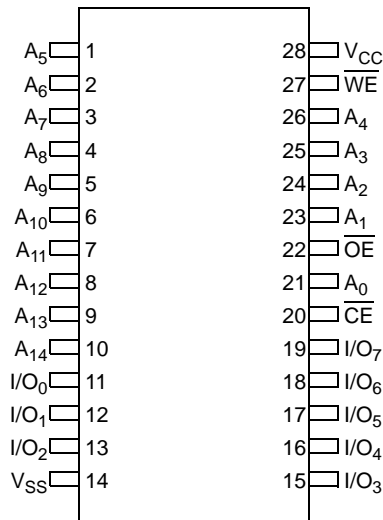

Pin Description

Pin	Type	Description	DIP	SOJ	TSOP I
A _X	Input	Address Inputs	1, 2, 3, 4, 5, 6, 7, 8, 9, 10, 21, 23, 24, 25, 26	1, 2, 3, 4, 5, 6, 7, 8, 9, 10, 21, 23, 24, 25, 26	2, 3, 4, 5, 8, 9, 10, 11, 12, 13, 14, 15, 16, 17, 28
\overline{CE}	Control	Chip Enable	20	20	27
I/O _X	Input or Output	Data Input/Outputs	11, 12, 13, 15, 16, 17, 18, 19	11, 12, 13, 15, 16, 17, 18, 19	18, 19, 20, 22, 23, 24, 25, 26
\overline{OE}	Control	Output Enable	22	22	1
V _{CC}	Supply	Power (5.0V)	28	28	7
V _{SS}	Supply	Ground	14	14	21
\overline{WE}	Control	Write Enable	27	27	6

Maximum Ratings (Above which the useful life may be impaired. For user guidelines, not tested.)

Parameter	Description	Value	Unit
T _{STG}	Storage Temperature	-65 to +150	°C
T _{AMB}	Ambient Temperature with Power Applied (i.e., case temperature)	-55 to +125	°C
V _{CC}	Core Supply Voltage Relative to V _{SS}	-0.5 to +7.0	V
V _{IN} , V _{OUT}	DC Voltage Applied to any Pin Relative to V _{SS}	-0.5 to V _{CC} + 0.5	V
I _{OUT}	Output Short-Circuit Current	20	mA
V _{ESD}	Static Discharge Voltage (per MIL-STD-883, Method 3015)	> 2001	V
I _{LU}	Latch-up Current	> 200	mA

Operating Range

Range	Ambient Temperature (T _A)	Voltage Range (V _{CC})
Commercial	0°C to 70°C	5.0V ± 10%
Industrial	-40°C to 85°C	5.0V ± 10%

DC Electrical Characteristics Over the Operating Range ^[2]

Parameter	Description	Condition	12 ns		15 ns		20 ns		Unit
			Min.	Max.	Min.	Max.	Min.	Max.	
V _{IH}	Input HIGH Voltage		2.2	V _{CC} + 0.3	2.2	V _{CC} + 0.3	2.2	V _{CC} + 0.3	V
V _{IL}	Input LOW Voltage		-0.5	0.8	-0.5	0.8	-0.5	0.8	V
V _{OH}	Output HIGH Voltage	V _{CC} = Min., I _{OH} = -4.0 mA	2.4		2.4		2.4		V
V _{OL}	Output LOW Voltage	V _{CC} = Min., I _{OL} = 8.0 mA		0.4		0.4		0.4	V
I _{IX}	Input Leakage Current	GND ≤ V _I ≤ V _{CC}	-5	+5	-5	+5	-5	+5	μA
I _{OZ}	Output Leakage Current	GND ≤ V _I ≤ V _{CC} , Output Disabled	-5	+5	-5	+5	-5	+5	μA
I _{CC}	V _{CC} Operating Supply Current	V _{CC} = Max., I _{OUT} = 0 mA, f = F _{MAX} = 1/t _{RC}		85		80		75	mA
I _{SB1}	Automatic \overline{CE} Power-down Current TTL Inputs	Max. V _{CC} , $\overline{CE} \geq V_{IH}$, V _{IN} ≥ V _{IH} or V _{IN} ≤ V _{IL} , f = F _{MAX}		30		30		30	mA
			L			10			mA
I _{SB2}	Automatic \overline{CE} Power-down Current CMOS Inputs	Max. V _{CC} , $\overline{CE} \geq V_{CC} - 0.3V$, V _{IN} ≥ V _{CC} - 0.3V, or V _{IN} ≤ 0.3V, f = 0		10		10		10	mA
			L			500			μA

Note:

2. V_{IL} (min) = -2.0V for pulse durations of less than 20 ns.

Capacitance^[3]

Parameter	Description	Conditions	Max.	Unit
			ALL – PACKAGES	
C _{IN}	Input Capacitance	T _A = 25°C, f = 1 MHz, V _{CC} = 5.0V	8	pF
C _{OUT}	Output Capacitance		8	

Thermal Resistance^[4]

Parameter	Description	Conditions	TSOP I	SOJ	DIP	Unit
Θ _{JA}	Thermal Resistance (Junction to Ambient)	Still Air, soldered on a 3 x 4.5 square inch, two-layer printed circuit board	88.6	79	69.33	°C/W
Θ _{JC}	Thermal Resistance (Junction to Case)		21.94	41.42	31.62	

AC Test Loads and Waveforms

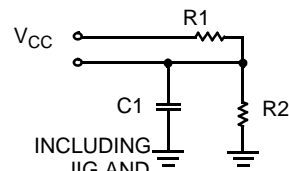

INCLUDING JIG AND SCOPE
(a)
output load

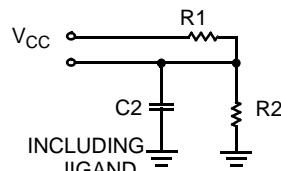

INCLUDING JIG AND SCOPE
(b)
output load for t_{HZOE}, t_{HZCE}, t_{HZWE}

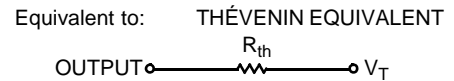
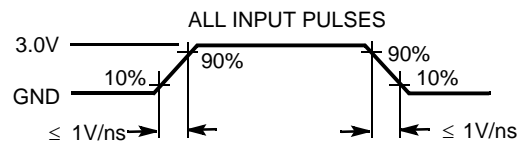

Notes:

3. Tested initially and after any design or process change that may affect these parameters.
4. Test Conditions assume a transition time of 3 ns or less, timing reference levels of 1.5V, input pulse levels of 0 to 3.0V.

AC Test Conditions

Parameter	Description	Nom.	Unit
C1	Capacitor 1	30	pF
C2	Capacitor 2	5	
R1	Resistor 1	480	Ω
R2	Resistor 2	255	
R _{TH}	Resistor Thevenin	167	
V _{TH}	Voltage Thevenin	1.73	V

AC Electrical Characteristics^[5, 6, 7]

Parameter	Description	12 ns		15 ns		20 ns		Unit
		Min	Max	Min	Max	Min	Max	
t _{RC}	Read Cycle Time	12		15		20		ns
t _{AA}	Address to Data Valid		12		15		20	ns
t _{OHA}	Data Hold from Address Change	3		3		3		ns
t _{ACE}	\overline{CE} to Data Valid		12		15		20	ns
t _{DOE}	\overline{OE} to Data Valid		5		7		9	ns
t _{LZOE}	\overline{OE} to Low Z	0		0		0		ns
t _{HZOE}	\overline{OE} to High Z		5		7		9	ns
t _{LZCE}	\overline{CE} to Low Z	3		3		3		ns
t _{HZCE}	\overline{CE} to High Z		5		7		9	ns
t _{PU}	\overline{CE} to Power-up	0		0		0		ns
t _{PD}	\overline{CE} to Power-down		12		15		20	ns
t _{WC}	Write Cycle Time	12		15		20		ns
t _{SCE}	\overline{CE} to Write End	9		10		15		ns
t _{AW}	Address Set-up to Write End	9		10		15		ns
t _{HA}	Address Hold from Write End	0		0		0		ns
t _{SA}	Address Set-up to Write Start	0		0		0		ns
t _{PWE}	\overline{WE} Pulse Width	8		9		15		ns
t _{SD}	Data Set-up to Write End	8		9		10		ns
t _{HD}	Data Hold from Write End	0		0		0		ns
t _{HZWE}	\overline{WE} LOW to High Z		7		7		10	ns
t _{LZWE}	\overline{WE} HIGH to Low Z	3		3		3		ns

Notes:

5. At any given temperature and voltage condition, t_{HZCE} is less than t_{LZCE}, t_{HZOE} is less than t_{LZOE}, and t_{HZWE} is less than t_{LZWE} for any given device.
6. The internal write time of the memory is defined by the overlap of \overline{CE} LOW and \overline{WE} LOW. \overline{CE} and \overline{WE} must be LOW to initiate a write, and the transition of any of these signals can terminate the write. The input data set-up and hold timing should be referenced to the leading edge of the signal that terminates the write.
7. t_{HZOE}, t_{HZCE}, t_{HZWE} are specified as in part (b) of the A/C Test Loads. Transitions are measured ± 200 mV from steady state voltage.

Data Retention Characteristics^[8]

Parameter	Description	Condition	ALL		Unit
			Min.	Max.	
V _{DR}	V _{CC} for Data Retention		2.0	–	V
I _{CCDR}	Data Retention Current	V _{CC} = V _{DR} = 2.0V, CE ≥ V _{CC} – 0.3V, V _{IN} ≥ V _{CC} – 0.3V or V _{IN} ≤ 0.3V	–	150	μA
t _{CDR}	Chip Deselect to Data Retention Time		0	–	ns
t _R	Operation Recovery Time		200	–	μs

Timing Waveforms

Data Retention Waveform

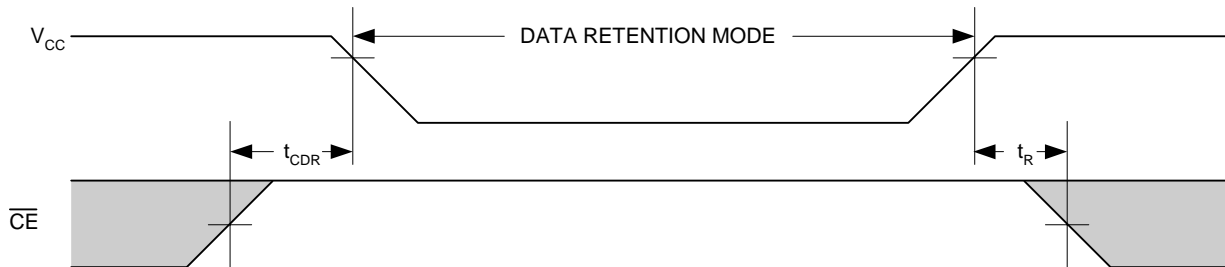

Read Cycle No. 1^[11, 10]

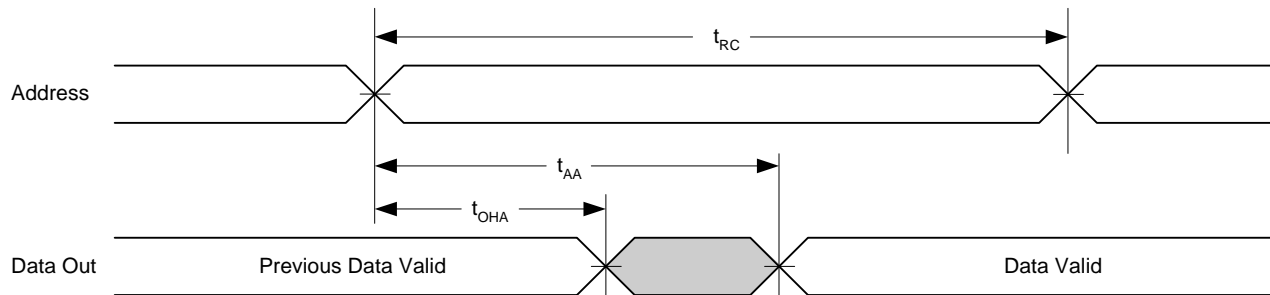

Notes:

- 8. L-version only.
- 9. Device is continuously selected. $\overline{OE} = V_{IL} = \overline{CE}$.
- 10. \overline{WE} is HIGH for Read Cycle.

Timing Waveforms (continued)

Read Cycle No. 2^[11, 12]

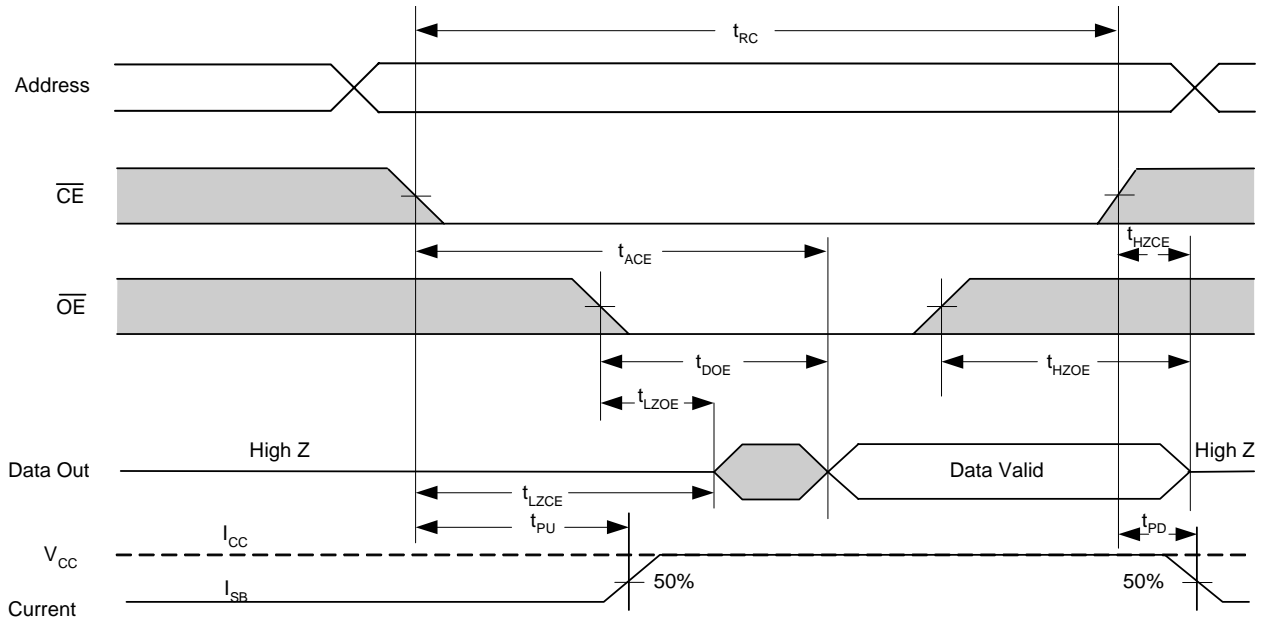

Write Cycle No. 1 (\overline{WE} Controlled)^[13, 14, 15]

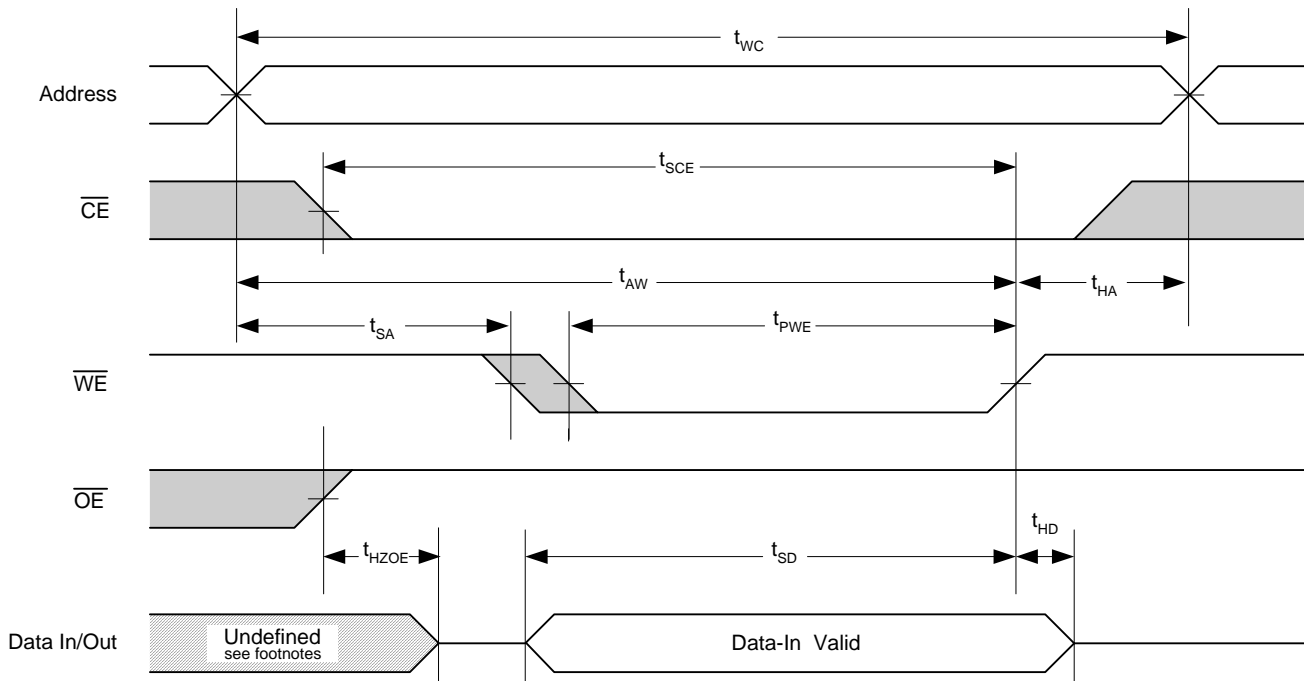

Notes:

- 11. This cycle is \overline{OE} Controlled and \overline{WE} is HIGH read cycle.
- 12. Address valid prior to or coincident with CE transition LOW.
- 13. This cycle is \overline{WE} controlled, \overline{OE} is HIGH during write.
- 14. Data In/Out is high impedance if $\overline{OE} = V_{IH}$.
- 15. During this period the I/Os are in output state and input signals should not be applied.

Timing Waveforms (continued)

Write Cycle No. 2 (\overline{CE} Controlled)^[14, 16, 17]

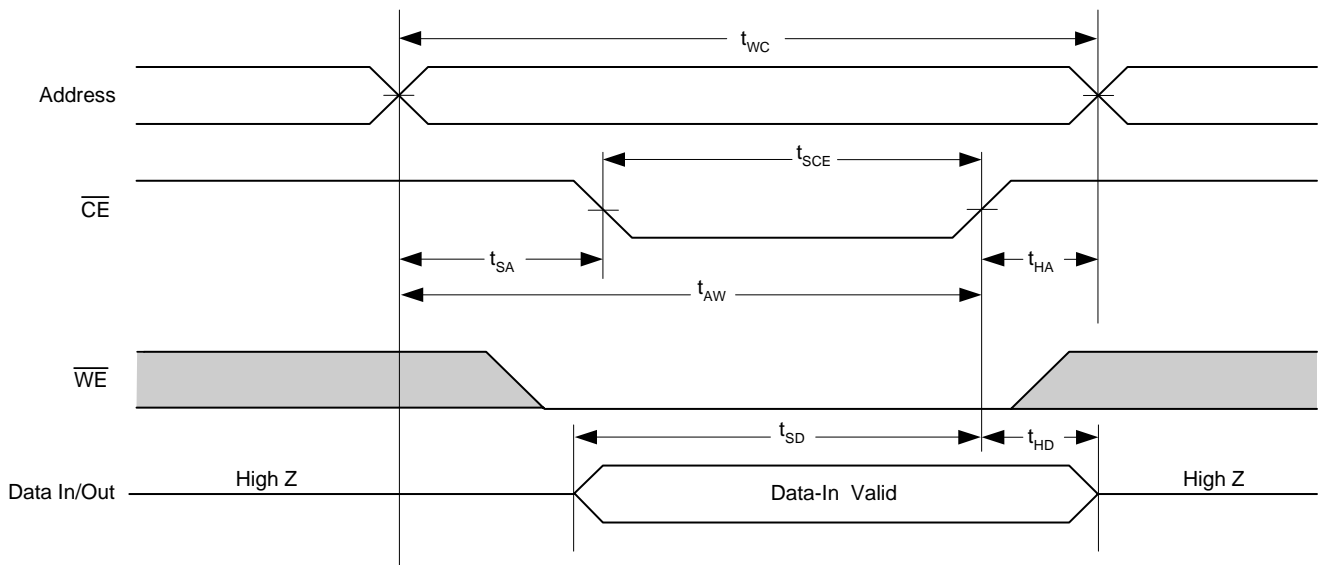

Write Cycle No. 3 (\overline{WE} Controlled, \overline{OE} Low)^[18]

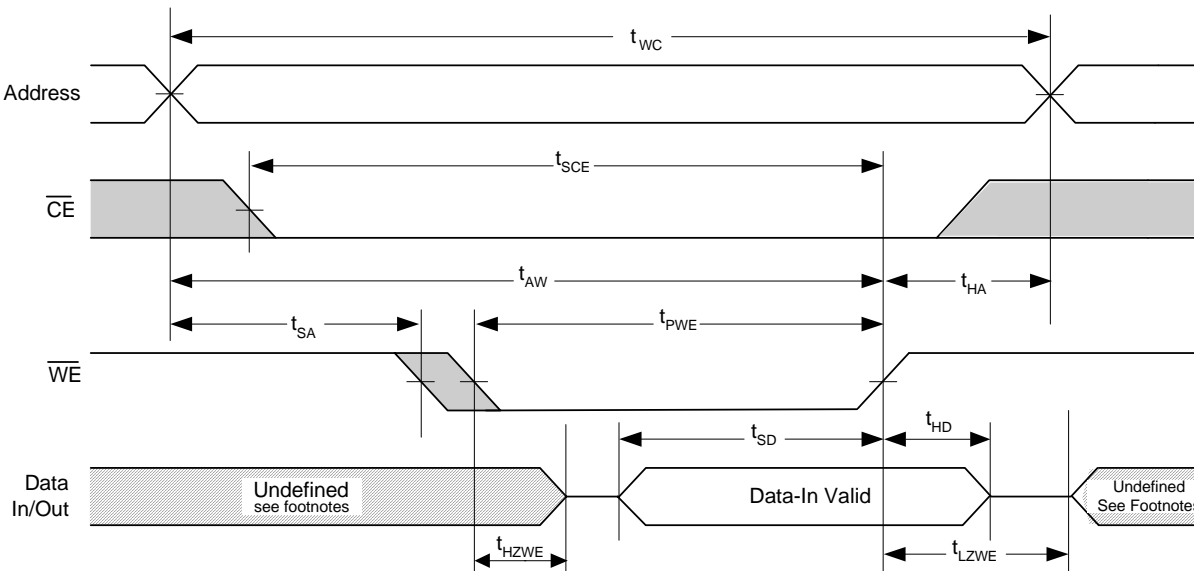

Notes:

- 16. This cycle is \overline{CE} controlled.
- 17. If \overline{CE} goes HIGH simultaneously with \overline{WE} going HIGH, the output remains in a high-impedance state.
- 18. The cycle is \overline{WE} controlled, \overline{OE} LOW. The minimum write cycle time is the sum of t_{HZWE} and t_{SD} .

Truth Table

CE	WE	OE	Input/Output	Mode	Power
H	X	X	High Z	Deselect/Power-Down	Standby (I_{SB})
L	H	L	Data Out	Read	Active (I_{CC})
L	L	X	Data In	Write	Active (I_{CC})
L	H	H	High Z	Deselect	Active (I_{CC})

Ordering Information

Speed	Ordering Code	Package Name	Package Type	Operating Range
12	CY7C199C-12VC	51-85031	28-pin (300-Mil) Molded SOJ	Commercial
	CY7C199C-12VXC		28-pin (300-Mil) Molded SOJ (Pb-Free)	
	CY7C199C-12ZXC	51-85071	28-pin TSOP I (Pb-Free)	Industrial
	CY7C199C-12VI	51-85031	28-pin (300-Mil) Molded SOJ	
15	CY7C199C-15PC	51-85014	28-pin (300-Mil) DIP	Commercial
	CY7C199C-15PXC		28-pin (300-Mil) DIP (Pb-Free)	
	CY7C199C-15ZC	51-85071	28-pin TSOP I	
	CY7C199C-15ZXC		28-pin TSOP I (Pb-Free)	
	CY7C199C-15VC	51-85031	28-pin (300-Mil) Molded SOJ	
	CY7C199C-15VXC		28-pin (300-Mil) Molded SOJ (Pb-Free)	
	CY7C199CL-15VC		28-pin (300-Mil) Molded SOJ	
	CY7C199CL-15VXC		28-pin (300-Mil) Molded SOJ (Pb-Free)	
	CY7C199C-15VI	51-85031	28-pin (300-Mil) Molded SOJ	Industrial
20	CY7C199C-20ZXI	51-85071	28-pin TSOP I (Pb-Free)	Industrial

Package Diagrams

28-pin TSOP 1 (8 x 13.4 mm) (51-85071)

NOTE: ORIENTATION I.D. MAY BE LOCATED EITHER AS SHOWN IN OPTION 1 OR OPTION 2

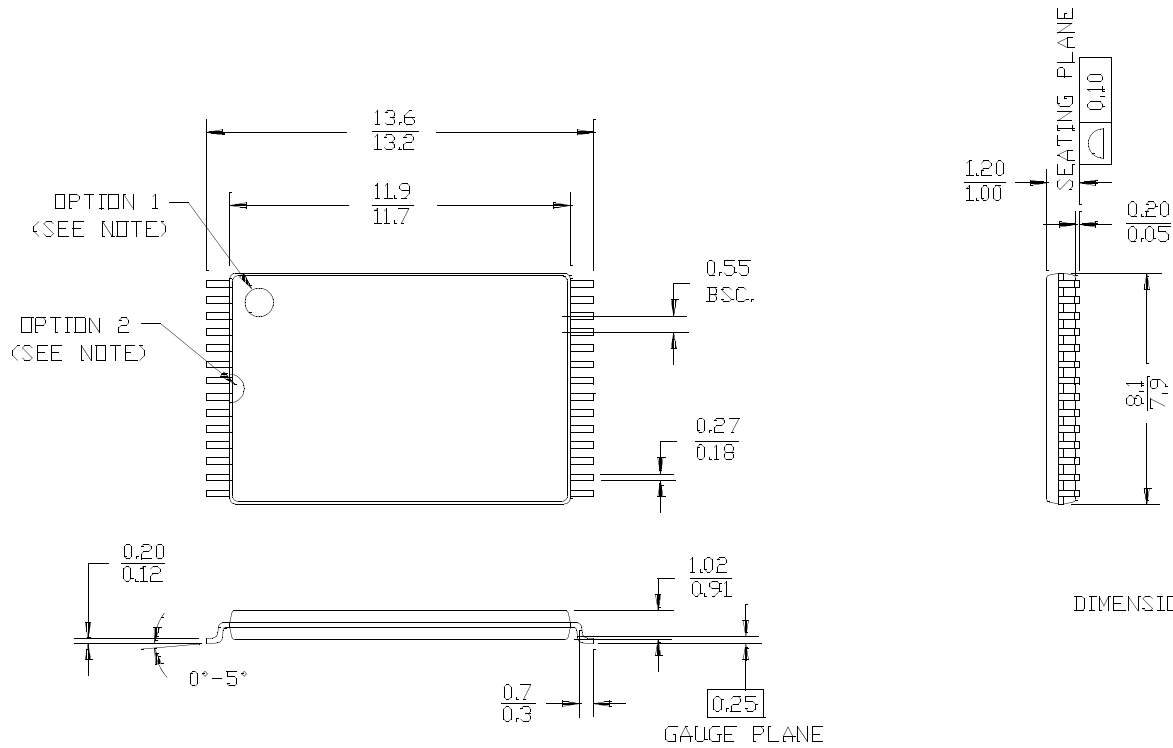

DIMENSION IN MM
MAX.
MIN.

51-85071-*G

Package Diagrams (continued)

28-pin (300-Mil) Molded SOJ (51-85031)

NOTE :

1. JEDEC STD REF MO088
2. BODY LENGTH DIMENSION DOES NOT INCLUDE MOLD PROTRUSION/END FLASH
MOLD PROTRUSION/END FLASH SHALL NOT EXCEED 0.006 in (0.152 mm) PER SIDE
3. DIMENSIONS IN INCHES
MIN.
MAX.

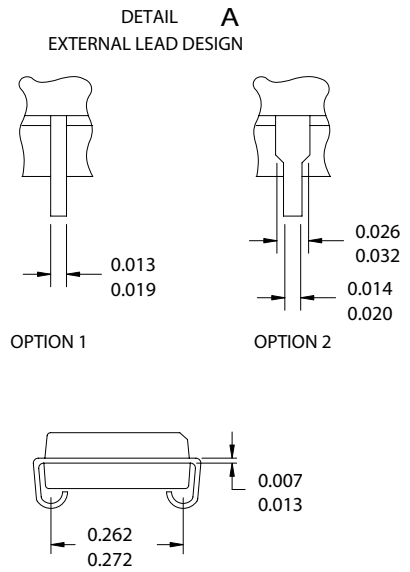
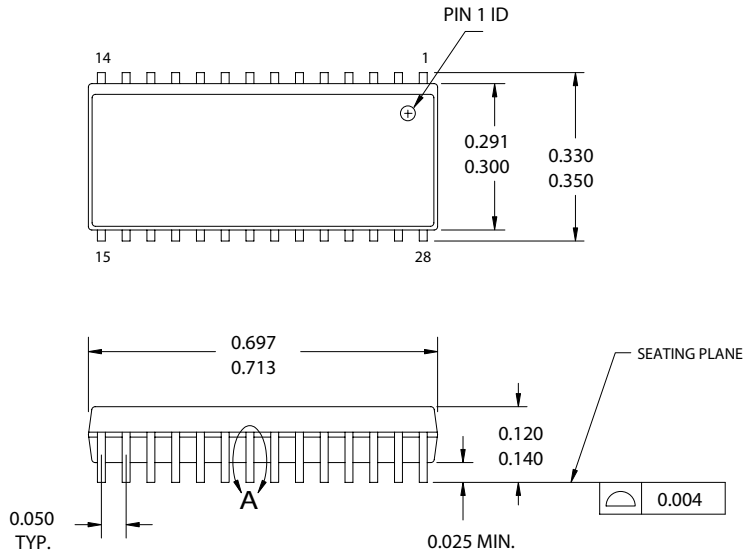

51-85031-C

Package Diagrams (continued)

28-pin (300-Mil) PDIP (51-85014)

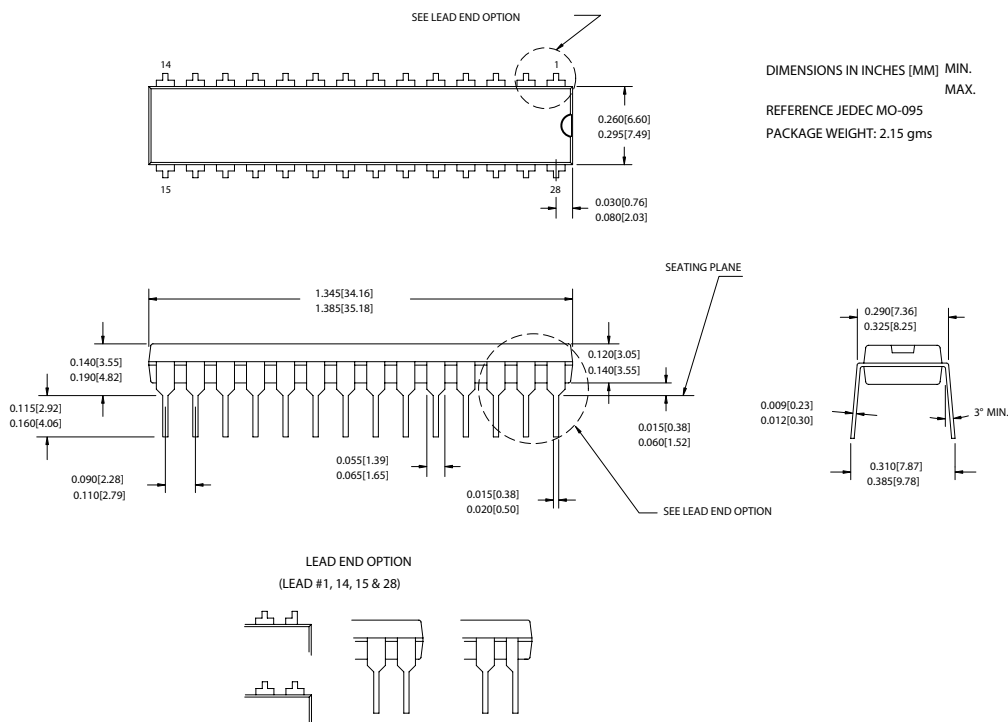

51-85014-*D

All product and company names mentioned in this document may be the trademarks of their respective holders.

Document History Page

Document Title: CY7C199C 256K (32K x 8) Static RAM Document Number: 38-05408				
REV.	ECN No.	Issue Date	Orig. of Change	Description of Change
**	129233	09/11/03	HGK	New Data Sheet
*A	129697	09/15/03	KKV	Minor change: Move Product Portfolio from page 4 to page 1 Move Truth table from page 9 to page 3
*B	341574	See ECN	PCI	Added Lead-Free part to Ordering info on Page #10
*C	492500	See ECN	NXR	Removed 25 ns speed bin Changed the description of I_{IX} from Input Load Current to Input Leakage Current in DC Electrical Characteristics table Removed I_{OS} parameter from DC Electrical Characteristics table Updated the ordering information table