



NXPS20H110C

Dual power Schottky diode

Rev. 2 — 24 May 2012

Product data sheet

1. Product profile

1.1 General description

Dual common cathode power Schottky diode designed for high frequency switched mode power supplies in a SOT78 (TO-220AB) plastic package.

1.2 Features and benefits

- High junction temperature capability
- Low leakage current
- Negligible switching losses
- Optimised design to give low V_F and high $T_{j(max)}$

1.3 Applications

- DC to DC converters
- Freewheeling diode
- OR-ing diode
- Switched mode power supply rectifier

1.4 Quick reference data

Table 1. Quick reference data

Symbol	Parameter	Conditions	Min	Typ	Max	Unit
V_{RRM}	repetitive peak reverse voltage		-	-	110	V
$I_{F(AV)}$	average forward current	square-wave pulse; $\delta = 0.5$; $T_j \leq 163$ °C; per diode; see Figure 1 ; see Figure 2 ; see Figure 3	-	-	10	A
$I_{O(AV)}$	average output current	square-wave pulse; $\delta = 0.5$; $T_{mb} \leq 161$ °C; both diodes conducting	-	-	20	A
T_j	junction temperature		-	-	175	°C
Static characteristics						
V_F	forward voltage	$I_F = 10$ A; $T_j = 25$ °C; see Figure 6	-	-	0.77	V
		$I_F = 10$ A; $T_j = 125$ °C; see Figure 6	-	0.59	0.64	V
I_R	reverse current	$V_R = 110$ V; $T_j = 25$ °C; see Figure 7	-	2.5	6	μ A
		$V_R = 110$ V; $T_j = 125$ °C; see Figure 7	-	1.5	6.5	mA



2. Pinning information

Table 2. Pinning information

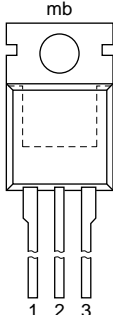
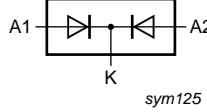
Pin	Symbol	Description	Simplified outline	Graphic symbol
1	A1	anode 1		
2	K	cathode		
3	A2	anode 2		
mb	K	mounting base; cathode		

SOT78 (TO-220AB)

3. Ordering information

Table 3. Ordering information

Type number	Package		
	Name	Description	Version
NXPS20H110C	TO-220AB	plastic single-ended package; heatsink mounted; 1 mounting hole; 3-lead TO-220AB	SOT78

4. Limiting values

Table 4. Limiting values

In accordance with the Absolute Maximum Rating System (IEC 60134).

Symbol	Parameter	Conditions	Min	Max	Unit
V_{RRM}	repetitive peak reverse voltage		-	110	V
$I_{F(AV)}$	average forward current	square-wave pulse; $\delta = 0.5$; $T_j \leq 163$ °C; per diode; see Figure 1 ; see Figure 2 ; see Figure 3	-	10	A
$I_{O(AV)}$	average output current	square-wave pulse; $\delta = 0.5$; $T_{mb} \leq 161$ °C; both diodes conducting	-	20	A
I_{FSM}	non-repetitive peak forward current	sine-wave pulse; $t_p = 10$ ms; $T_{j(init)} = 25$ °C; see Figure 4	-	250	A
T_{stg}	storage temperature		-65	175	°C
T_j	junction temperature		-	175	°C

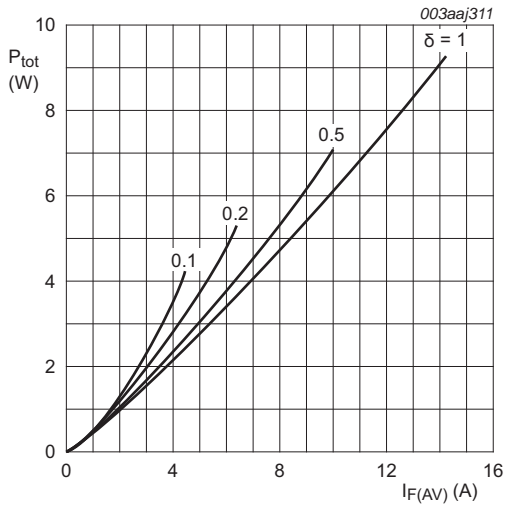

$$I_{F(AV)} = I_{F(RMS)} \times \sqrt{\delta}$$

$V_O = 0.516 \text{ V}; R_S = 0.010 \Omega$

Fig 1. Forward power dissipation as a function of average forward current; square waveform; per diode; maximum values

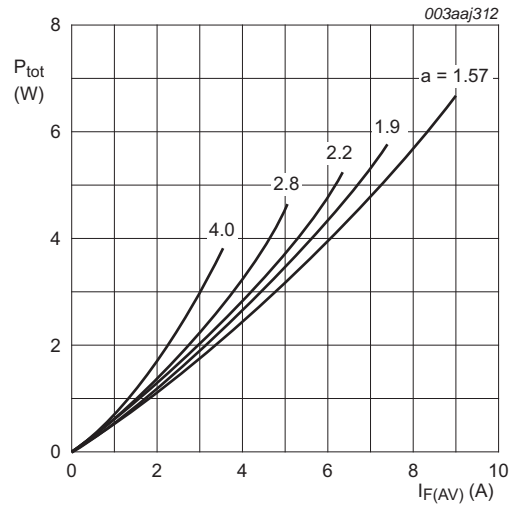

$a = \text{form factor} = I_{F(RMS)} / I_{F(AV)}$

$V_O = 0.516 \text{ V}; R_S = 0.010 \Omega$

Fig 2. Forward power dissipation as a function of average forward current; sinusoidal waveform; per diode; maximum values

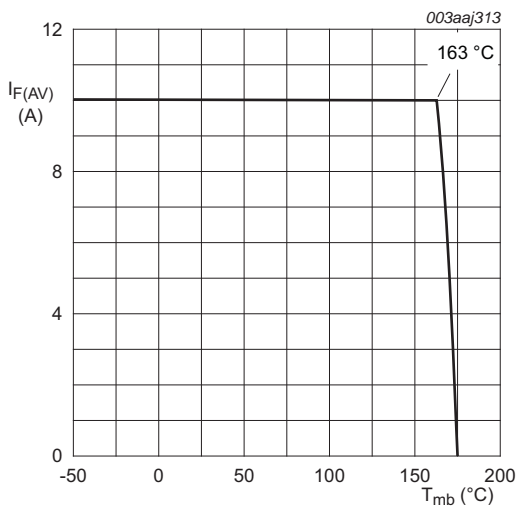

Fig 3. Average forward current as a function of mounting base temperature; per diode; maximum values

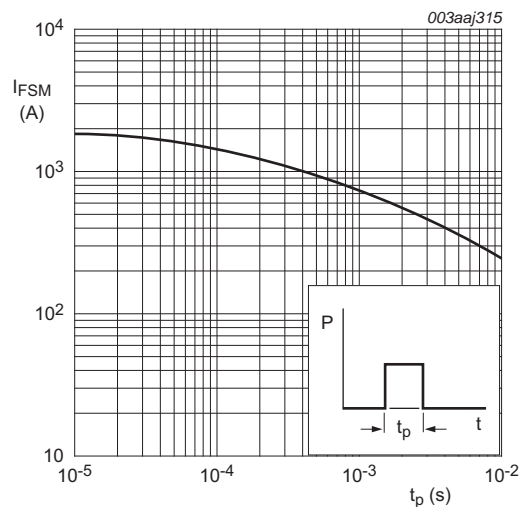
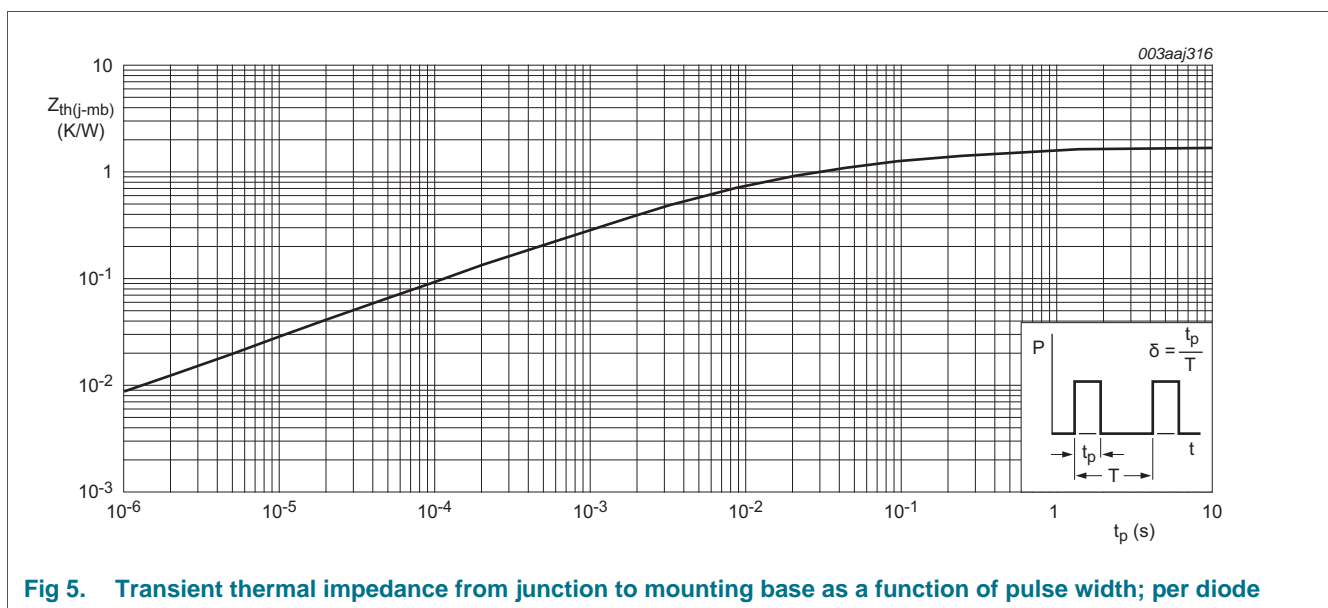

Fig 4. Non-repetitive peak forward current as a function of pulse width; square waveform; per diode; maximum values

5. Thermal characteristics

Table 5. Thermal characteristics

Symbol	Parameter	Conditions	Min	Typ	Max	Unit
$R_{th(j-mb)}$	thermal resistance from junction to mounting base	with heatsink compound; per diode; see Figure 5	-	-	1.6	K/W
		with heatsink compound; both diodes conducting	-	-	0.9	K/W
$R_{th(j-a)}$	thermal resistance from junction to ambient	in free air	-	60	-	K/W



6. Characteristics

Table 6. Characteristics

Symbol	Parameter	Conditions	Min	Typ	Max	Unit
Static characteristics						
V _F	forward voltage	I _F = 8 A; T _j = 25 °C; see Figure 6	-	-	0.71	V
		I _F = 10 A; T _j = 25 °C; see Figure 6	-	-	0.77	V
		I _F = 16 A; T _j = 25 °C; see Figure 6	-	-	0.81	V
		I _F = 20 A; T _j = 25 °C; see Figure 6	-	-	0.88	V
		I _F = 8 A; T _j = 125 °C; see Figure 6	-	0.56	0.58	V
		I _F = 10 A; T _j = 125 °C; see Figure 6	-	0.59	0.64	V
		I _F = 16 A; T _j = 125 °C; see Figure 6	-	0.65	0.68	V
		I _F = 20 A; T _j = 125 °C; see Figure 6	-	0.67	0.73	V
I _R	reverse current	V _R = 110 V; T _j = 25 °C; see Figure 7	-	2.5	6	µA
		V _R = 110 V; T _j = 125 °C; see Figure 7	-	1.5	6.5	mA
Dynamic characteristics						
C _d	diode capacitance	f = 1 MHz; V _R = 10 V; T _j = 25 °C; see Figure 8	-	250	-	pF

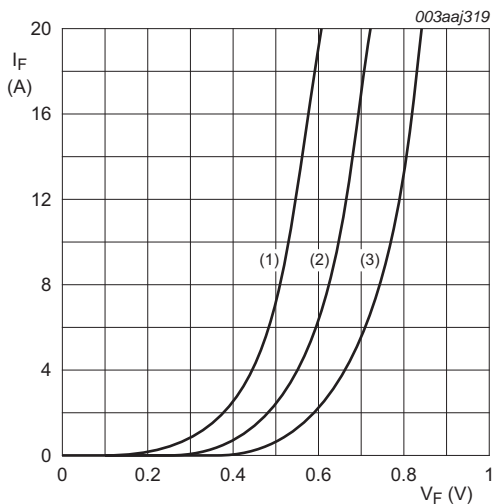

(1) T_j = 125 °C; typical values;
 (2) T_j = 125 °C; maximum values;
 (3) T_j = 25 °C; maximum values;
 V_O = 0.516 V; R_S = 0.010 Ω

Fig 6. Forward current as a function of forward voltage; per diode

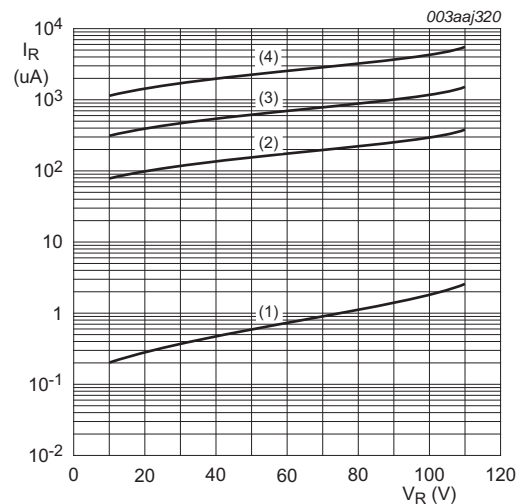

(1) T_j = 25 °C; typical values;
 (2) T_j = 100 °C; typical values;
 (3) T_j = 125 °C; typical values;
 (4) T_j = 150 °C; typical values

Fig 7. Reverse leakage current as a function of reverse voltage; per diode; typical values

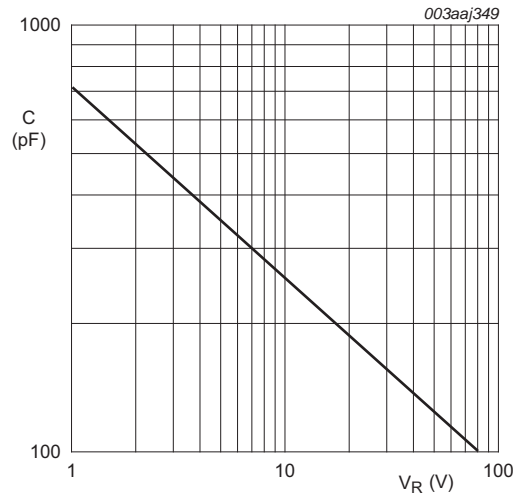

f = 1 MHz; T_j = 25 °C

Fig 8. Junction capacitance as a function of applied reverse voltage;per diode; typical values

7. Package outline

Plastic single-ended package; heatsink mounted; 1 mounting hole; 3-lead TO-220AB

SOT78

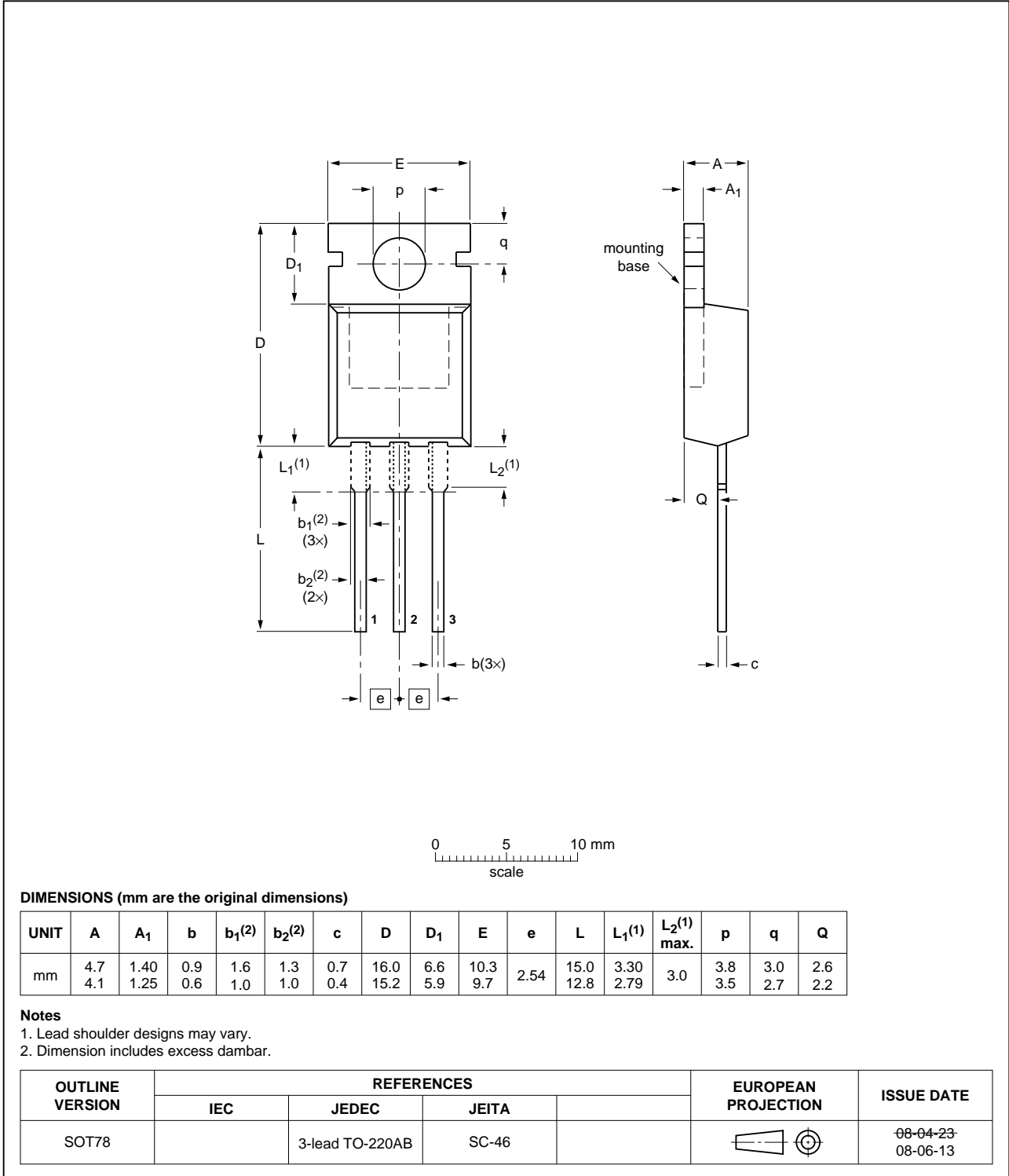

Fig 9. Package outline SOT78 (TO-220AB)

8. Revision history

Table 7. Revision history

Document ID	Release date	Data sheet status	Change notice	Supersedes
NXPS20H110C v.2	20120524	Product data sheet	-	NXPS20H110C v.1
Modifications:	<ul style="list-style-type: none">• Status changed from preliminary to product.• Various changes to content.			
NXPS20H110C v.1	20120420	Preliminary data sheet	-	-

9. Legal information

9.1 Data sheet status

Document status ^[1] [2]	Product status ^[3]	Definition
Objective [short] data sheet	Development	This document contains data from the objective specification for product development.
Preliminary [short] data sheet	Qualification	This document contains data from the preliminary specification.
Product [short] data sheet	Production	This document contains the product specification.

[1] Please consult the most recently issued document before initiating or completing a design.

[2] The term 'short data sheet' is explained in section "Definitions".

[3] The product status of device(s) described in this document may have changed since this document was published and may differ in case of multiple devices. The latest product status information is available on the Internet at URL <http://www.nxp.com>.

9.2 Definitions

Preview — The document is a preview version only. The document is still subject to formal approval, which may result in modifications or additions. NXP Semiconductors does not give any representations or warranties as to the accuracy or completeness of information included herein and shall have no liability for the consequences of use of such information.

Draft — The document is a draft version only. The content is still under internal review and subject to formal approval, which may result in modifications or additions. NXP Semiconductors does not give any representations or warranties as to the accuracy or completeness of information included herein and shall have no liability for the consequences of use of such information.

Short data sheet — A short data sheet is an extract from a full data sheet with the same product type number(s) and title. A short data sheet is intended for quick reference only and should not be relied upon to contain detailed and full information. For detailed and full information see the relevant full data sheet, which is available on request via the local NXP Semiconductors sales office. In case of any inconsistency or conflict with the short data sheet, the full data sheet shall prevail.

Product specification — The information and data provided in a Product data sheet shall define the specification of the product as agreed between NXP Semiconductors and its customer, unless NXP Semiconductors and customer have explicitly agreed otherwise in writing. In no event however, shall an agreement be valid in which the NXP Semiconductors product is deemed to offer functions and qualities beyond those described in the Product data sheet.

9.3 Disclaimers

Limited warranty and liability — Information in this document is believed to be accurate and reliable. However, NXP Semiconductors does not give any representations or warranties, expressed or implied, as to the accuracy or completeness of such information and shall have no liability for the consequences of use of such information. NXP Semiconductors takes no responsibility for the content in this document if provided by an information source outside of NXP Semiconductors.

In no event shall NXP Semiconductors be liable for any indirect, incidental, punitive, special or consequential damages (including - without limitation - lost profits, lost savings, business interruption, costs related to the removal or replacement of any products or rework charges) whether or not such damages are based on tort (including negligence), warranty, breach of contract or any other legal theory.

Notwithstanding any damages that customer might incur for any reason whatsoever, NXP Semiconductors' aggregate and cumulative liability towards customer for the products described herein shall be limited in accordance with the *Terms and conditions of commercial sale* of NXP Semiconductors.

Right to make changes — NXP Semiconductors reserves the right to make changes to information published in this document, including without limitation specifications and product descriptions, at any time and without notice. This document supersedes and replaces all information supplied prior to the publication hereof.

Suitability for use — NXP Semiconductors products are not designed, authorized or warranted to be suitable for use in life support, life-critical or safety-critical systems or equipment, nor in applications where failure or malfunction of an NXP Semiconductors product can reasonably be expected to result in personal injury, death or severe property or environmental damage. NXP Semiconductors and its suppliers accept no liability for inclusion and/or use of NXP Semiconductors products in such equipment or applications and therefore such inclusion and/or use is at the customer's own risk.

Quick reference data — The Quick reference data is an extract of the product data given in the Limiting values and Characteristics sections of this document, and as such is not complete, exhaustive or legally binding.

Applications — Applications that are described herein for any of these products are for illustrative purposes only. NXP Semiconductors makes no representation or warranty that such applications will be suitable for the specified use without further testing or modification.

Customers are responsible for the design and operation of their applications and products using NXP Semiconductors products, and NXP Semiconductors accepts no liability for any assistance with applications or customer product design. It is customer's sole responsibility to determine whether the NXP Semiconductors product is suitable and fit for the customer's applications and products planned, as well as for the planned application and use of customer's third party customer(s). Customers should provide appropriate design and operating safeguards to minimize the risks associated with their applications and products.

NXP Semiconductors does not accept any liability related to any default, damage, costs or problem which is based on any weakness or default in the customer's applications or products, or the application or use by customer's third party customer(s). Customer is responsible for doing all necessary testing for the customer's applications and products using NXP Semiconductors products in order to avoid a default of the applications and the products or of the application or use by customer's third party customer(s). NXP does not accept any liability in this respect.

Limiting values — Stress above one or more limiting values (as defined in the Absolute Maximum Ratings System of IEC 60134) will cause permanent damage to the device. Limiting values are stress ratings only and (proper) operation of the device at these or any other conditions above those given in the Recommended operating conditions section (if present) or the Characteristics sections of this document is not warranted. Constant or repeated exposure to limiting values will permanently and irreversibly affect the quality and reliability of the device.

Terms and conditions of commercial sale — NXP Semiconductors products are sold subject to the general terms and conditions of commercial sale, as published at <http://www.nxp.com/profile/terms>, unless otherwise agreed in a valid written individual agreement. In case an individual agreement is concluded only the terms and conditions of the respective agreement shall apply. NXP Semiconductors hereby expressly objects to applying the customer's general terms and conditions with regard to the purchase of NXP Semiconductors products by customer.

No offer to sell or license — Nothing in this document may be interpreted or construed as an offer to sell products that is open for acceptance or the grant, conveyance or implication of any license under any copyrights, patents or other industrial or intellectual property rights.

Export control — This document as well as the item(s) described herein may be subject to export control regulations. Export might require a prior authorization from competent authorities.

Non-automotive qualified products — Unless this data sheet expressly states that this specific NXP Semiconductors product is automotive qualified, the product is not suitable for automotive use. It is neither qualified nor tested in accordance with automotive testing or application requirements. NXP Semiconductors accepts no liability for inclusion and/or use of non-automotive qualified products in automotive equipment or applications.

In the event that customer uses the product for design-in and use in automotive applications to automotive specifications and standards, customer (a) shall use the product without NXP Semiconductors' warranty of the

product for such automotive applications, use and specifications, and (b) whenever customer uses the product for automotive applications beyond NXP Semiconductors' specifications such use shall be solely at customer's own risk, and (c) customer fully indemnifies NXP Semiconductors for any liability, damages or failed product claims resulting from customer design and use of the product for automotive applications beyond NXP Semiconductors' standard warranty and NXP Semiconductors' product specifications.

Translations — A non-English (translated) version of a document is for reference only. The English version shall prevail in case of any discrepancy between the translated and English versions.

9.4 Trademarks

Notice: All referenced brands, product names, service names and trademarks are the property of their respective owners.

Adelante, Bitport, Bitsound, CoolFlux, CoReUse, DESFire, EZ-HV, FabKey, GreenChip, HiPerSmart, HITAG, I²C-bus logo, ICODE, I-CODE, ITEC, Labelution, MIFARE, MIFARE Plus, MIFARE Ultralight, MoReUse, QLPK, Silicon Tuner, SiliconMAX, SmartXA, STARplug, TOPFET, TrenchMOS, TriMedia and UCODE — are trademarks of NXP B.V.

HD Radio and HD Radio logo — are trademarks of iBiquity Digital Corporation.

10. Contact information

For more information, please visit: <http://www.nxp.com>

For sales office addresses, please send an email to: salesaddresses@nxp.com

11. Contents

1	Product profile	1
1.1	General description	1
1.2	Features and benefits	1
1.3	Applications	1
1.4	Quick reference data	1
2	Pinning information	2
3	Ordering information	2
4	Limiting values	2
5	Thermal characteristics	4
6	Characteristics	5
7	Package outline	7
8	Revision history	8
9	Legal information	9
9.1	Data sheet status	9
9.2	Definitions	9
9.3	Disclaimers	9
9.4	Trademarks	10
10	Contact information	10

Please be aware that important notices concerning this document and the product(s) described herein, have been included in section 'Legal information'.