

PolarHT™ Power MOSFET

IXTQ69N30P
IXTT69N30P

$V_{DSS} = 300 \text{ V}$
 $I_{D25} = 69 \text{ A}$
 $R_{DS(on)} \leq 49 \text{ m}\Omega$

N-Channel Enhancement Mode
Avalanche Rated



Symbol	Test Conditions	Maximum Ratings	
V_{DSS}	$T_J = 25^\circ\text{C to } 150^\circ\text{C}$	300	V
V_{DGR}	$T_J = 25^\circ\text{C to } 150^\circ\text{C}; R_{GS} = 1 \text{ M}\Omega$	300	V
V_{GSS}	Continuous	± 20	V
V_{GSM}	Transient	± 30	V
I_{D25}	$T_C = 25^\circ\text{C}$	69	A
I_{DM}	$T_C = 25^\circ\text{C}$, pulse width limited by T_{JM}	200	A
I_{AR}	$T_C = 25^\circ\text{C}$	69	A
E_{AR}	$T_C = 25^\circ\text{C}$	50	mJ
E_{AS}	$T_C = 25^\circ\text{C}$	1.5	J
dv/dt	$I_S \leq I_{DM}$, $di/dt \leq 100 \text{ A}/\mu\text{s}$, $V_{DD} \leq V_{DSS}$, $T_J \leq 150^\circ\text{C}$, $R_G = 4 \Omega$	10	V/ns
P_D	$T_C = 25^\circ\text{C}$	500	W
T_J		-55 ... +150	$^\circ\text{C}$
T_{JM}		150	$^\circ\text{C}$
T_{stg}		-55 ... +150	$^\circ\text{C}$
T_L	1.6 mm (0.062 in.) from case for 10 s	300	$^\circ\text{C}$
T_{SOLD}	Plastic body for 10 s	260	$^\circ\text{C}$
M_d	Mounting torque (TO-3P)	1.13/10	Nm/lb.in.
Weight	TO-3P	5.5	g
	TO-268	5.0	g

TO-3P (IXTQ)



TO-268 (IXTT)

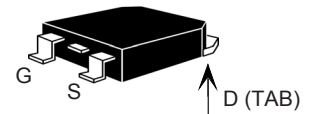

G = Gate D = Drain
S = Source TAB = Drain

Features

- † International standard packages
- † Unclamped Inductive Switching (UIS) rated
- † Low package inductance
- easy to drive and to protect

Advantages

- † Easy to mount
- † Space savings
- † High power density

Symbol	Test Conditions ($T_J = 25^\circ\text{C}$, unless otherwise specified)	Characteristic Values		
		Min.	Typ.	Max.
BV_{DSS}	$V_{GS} = 0 \text{ V}$, $I_D = 250 \mu\text{A}$	300		V
$V_{GS(th)}$	$V_{DS} = V_{GS}$, $I_D = 250 \mu\text{A}$	2.5		5.0 V
I_{GSS}	$V_{GS} = \pm 20 \text{ V}_{DC}$, $V_{DS} = 0$			$\pm 100 \text{ nA}$
I_{DSS}	$V_{DS} = V_{DSS}$ $V_{GS} = 0 \text{ V}$ $T_J = 125^\circ\text{C}$			25 μA
				250 μA
$R_{DS(on)}$	$V_{GS} = 10 \text{ V}$, $I_D = 0.5 I_{D25}$ Pulse test, $t \leq 300 \mu\text{s}$, duty cycle $d \leq 2\%$			49 $\text{m}\Omega$

Symbol	Test Conditions	Characteristic Values		
		(T _J = 25°C, unless otherwise specified)		
		Min.	Typ.	Max.
g_{fs}	V _{DS} = 10 V; I _D = 0.5 I _{D25} , pulse test	30	48	S
C_{iss}	V _{GS} = 0 V, V _{DS} = 25 V, f = 1 MHz		4960	pF
C_{oss}			760	pF
C_{rss}			190	pF
t_{d(on)}	V _{GS} = 10 V, V _{DS} = 0.5 V _{DSS} , I _D = I _{D25} R _G = 4 Ω (External)		25	ns
t_r			25	ns
t_{d(off)}			75	ns
t_f			27	ns
Q_{g(on)}	V _{GS} = 10 V, V _{DS} = 0.5 V _{DSS} , I _D = 0.5 I _{D25}		156	180 nC
Q_{gs}			32	nC
Q_{gd}			79	nC
R_{thJC}	(TO-3P)			0.25° C/W
R_{thCS}			0.21	° C/W

Symbol	Test Conditions	Characteristic Values		
		(T _J = 25°C, unless otherwise specified)		
		Min.	Typ.	Max.
I_s	V _{GS} = 0 V			69 A
I_{SM}	Repetitive			200 A
V_{SD}	I _F = I _S , V _{GS} = 0 V, Pulse test, t ≤ 300 μs, duty cycle d ≤ 2 %			1.5 V
T_{rr}	I _F = 25 A, -di/dt = 100 A/μs V _R = 100 V, V _{GS} = 0V		250	ns
Q_{RM}			3.0	μC

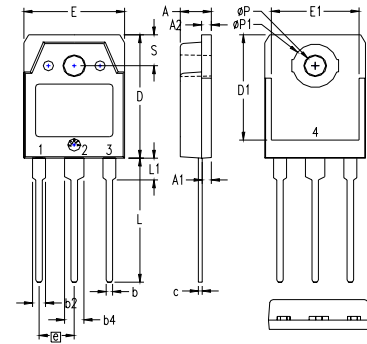
TO-3P (IXTQ) Outline

- 1 - GATE
- 2 - DRAIN (COLLECTOR)
- 3 - SOURCE (EMITTER)
- 4 - DRAIN (COLLECTOR)

SYM	INCHES		MILLIMETERS	
	MIN	MAX	MIN	MAX
A	.185	.193	4.70	4.90
A1	.051	.059	1.30	1.50
A2	.057	.065	1.45	1.65
b	.035	.045	0.90	1.15
b2	.075	.087	1.90	2.20
b4	.114	.126	2.90	3.20
c	.022	.031	0.55	0.80
D	.780	.799	19.80	20.30
D1	.665	.677	16.90	17.20
E	.610	.622	15.50	15.80
E1	.531	.539	13.50	13.70
e	.215 BSC		5.45 BSC	
L	.779	.795	19.80	20.20
L1	.134	.142	3.40	3.60
øP	.126	.134	3.20	3.40
øP1	.272	.280	6.90	7.10
S	.193	.201	4.90	5.10

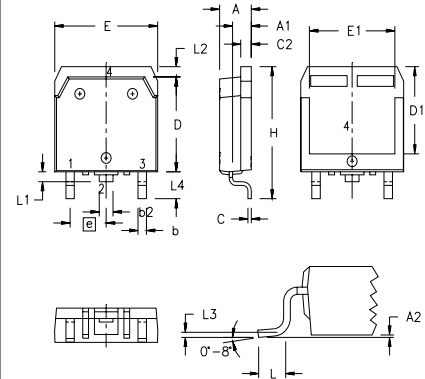
TO-268 (IXTT) Outline

SYM	INCHES		MILLIMETERS	
	MIN	MAX	MIN	MAX
A	.193	.201	4.90	5.10
A1	.106	.114	2.70	2.90
A2	.001	.010	0.02	0.25
b	.045	.057	1.15	1.45
b2	.075	.083	1.90	2.10
C	.016	.026	0.40	0.65
C2	.057	.063	1.45	1.60
D	.543	.551	13.80	14.00
D1	.488	.500	12.40	12.70
E	.624	.632	15.85	16.05
E1	.524	.535	13.30	13.60
e	.215 BSC		5.45 BSC	
H	.736	.752	18.70	19.10
L	.094	.106	2.40	2.70
L1	.047	.055	1.20	1.40
L2	.039	.045	1.00	1.15
L3	.010 BSC		0.25 BSC	
L4	.150	.161	3.80	4.10

IXYS reserves the right to change limits, test conditions, and dimensions.

IXYS MOSFETs and IGBTs are covered by	4,835,592	4,931,844	5,049,961	5,237,481	6,162,665	6,404,065 B1	6,683,344	6,727,585
one or more of the following U.S. patents:	4,850,072	5,017,508	5,063,307	5,381,025	6,259,123 B1	6,534,343	6,710,405B2	6,759,692
	4,881,106	5,034,796	5,187,117	5,486,715	6,306,728 B1	6,583,505	6,710,463	6,771,478 B2

Fig. 1. Output Characteristics @ 25 Deg. C

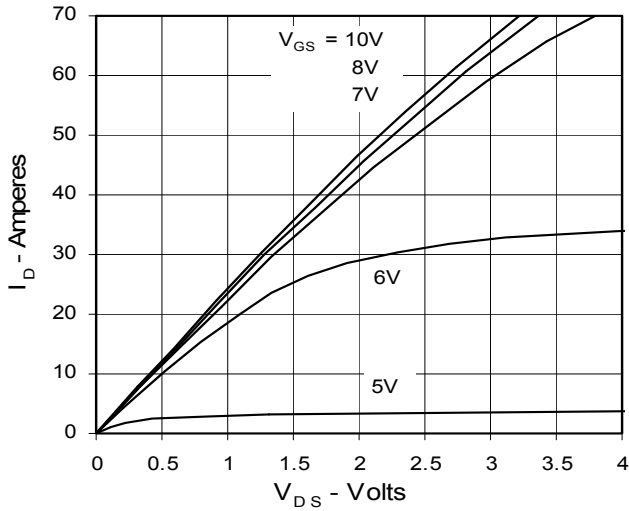

Fig. 2. Extended Output Characteristics @ 25 deg. C

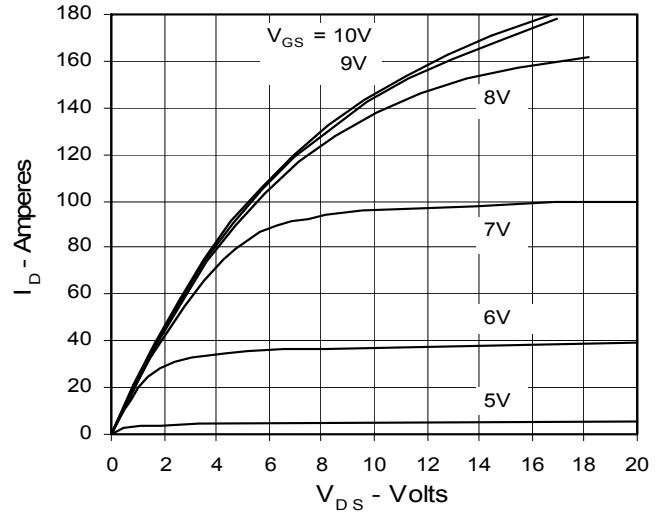

Fig. 3. Output Characteristics @ 125 Deg. C

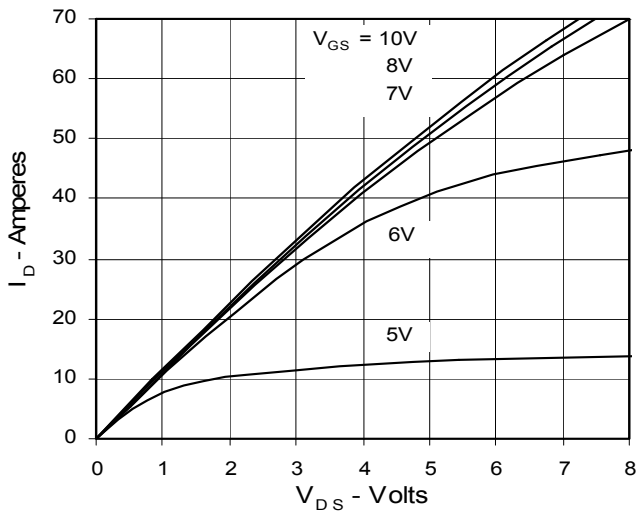

Fig. 4. $R_{DS(on)}$ Normalized to I_{D25} Value vs. Junction Temperature

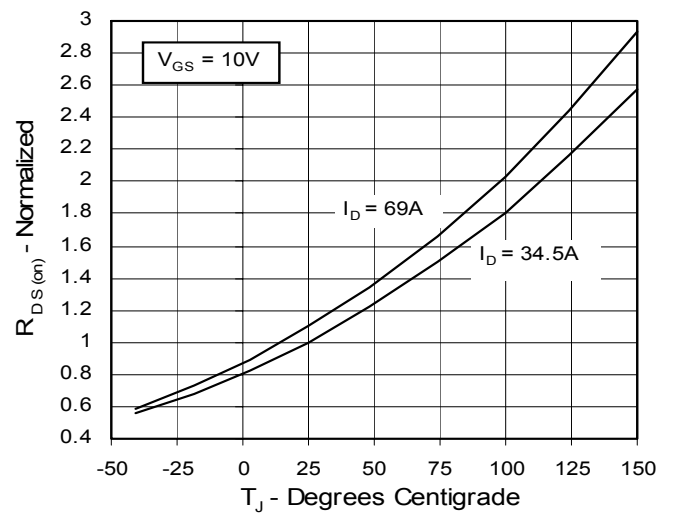

Fig. 5. $R_{DS(on)}$ Normalized to I_{D25} Value vs. I_D

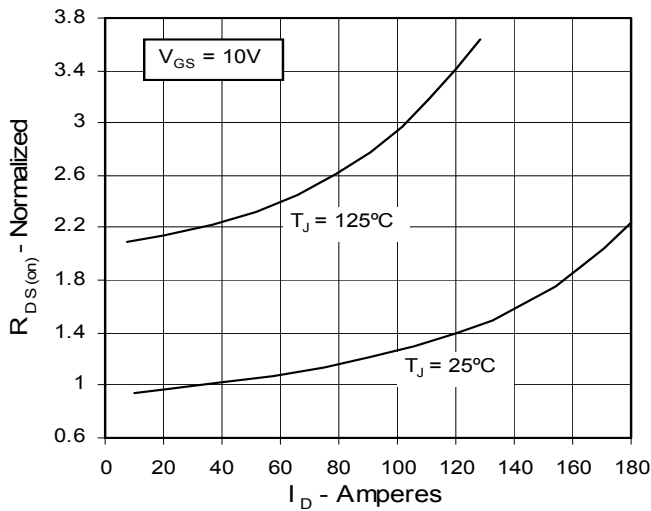

Fig. 6. Drain Current vs. Case Temperature

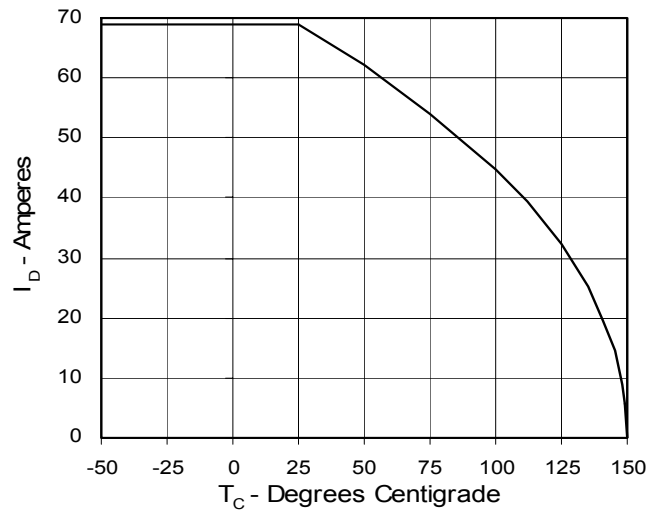

Fig. 7. Input Admittance

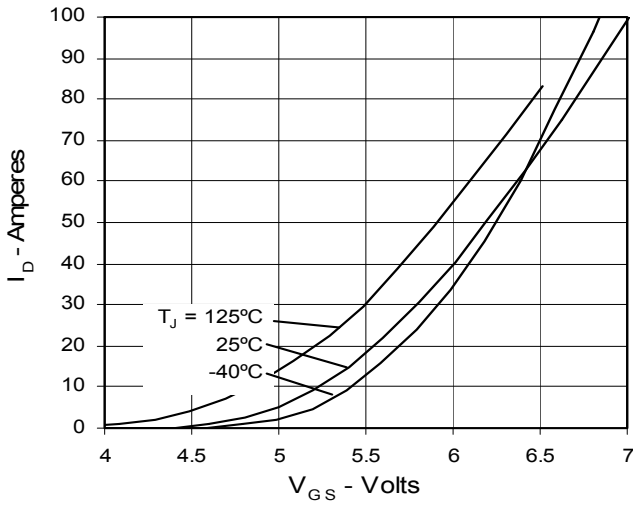

Fig. 8. Transconductance

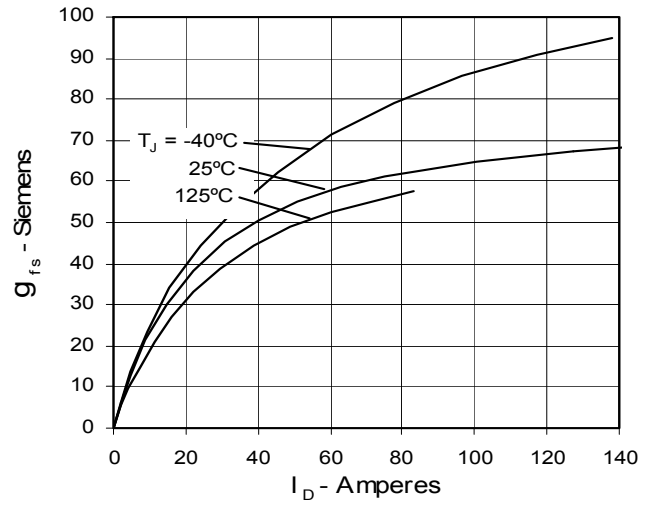

Fig. 9. Source Current vs. Source-To-Drain Voltage

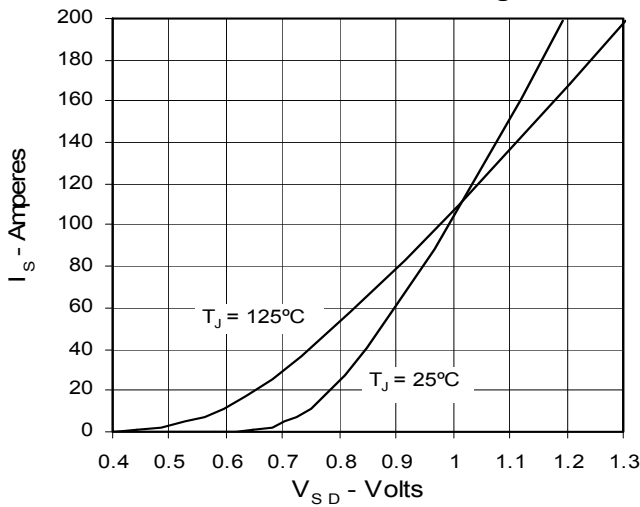

Fig. 10. Gate Charge

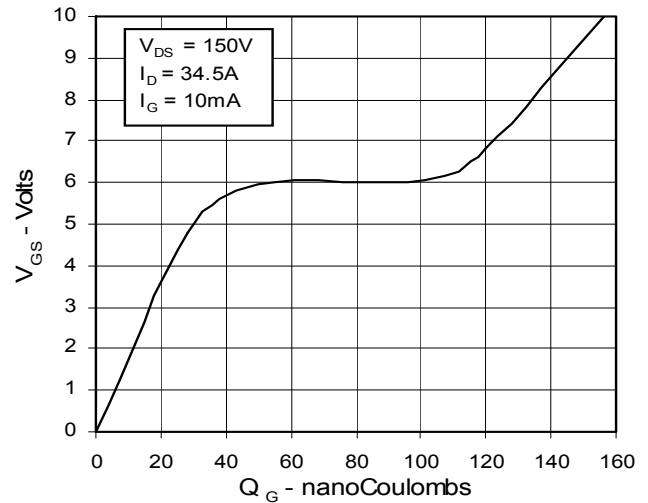

Fig. 11. Capacitance

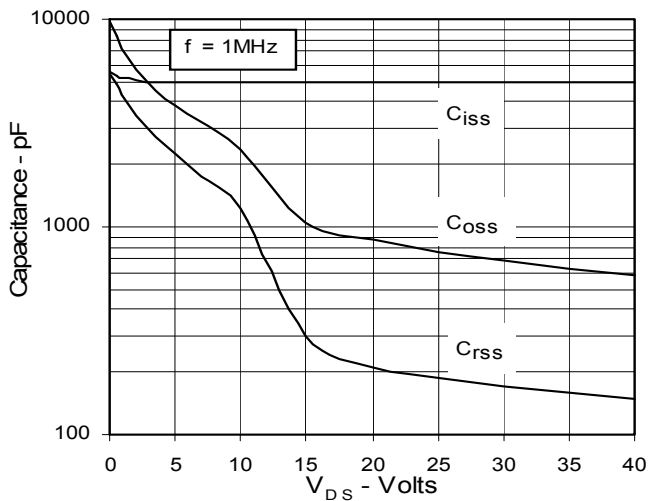

Fig. 12. Forward-Bias Safe Operating Area

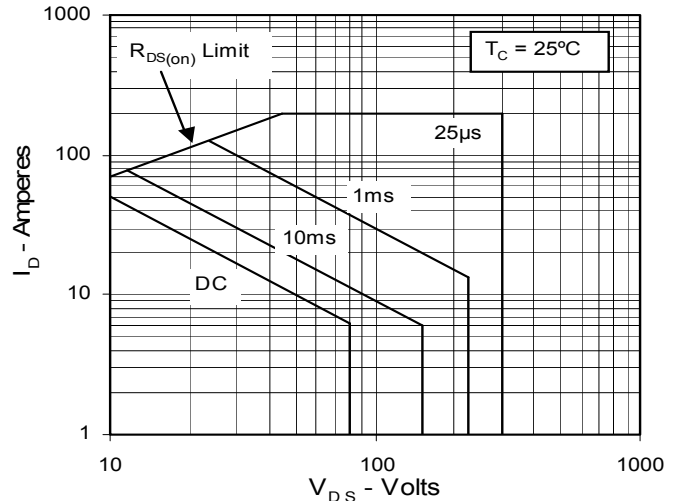

Fig. 13. Maximum Transient Thermal Resistance

