

GravityTM

Analog Dissolved Oxygen Meter

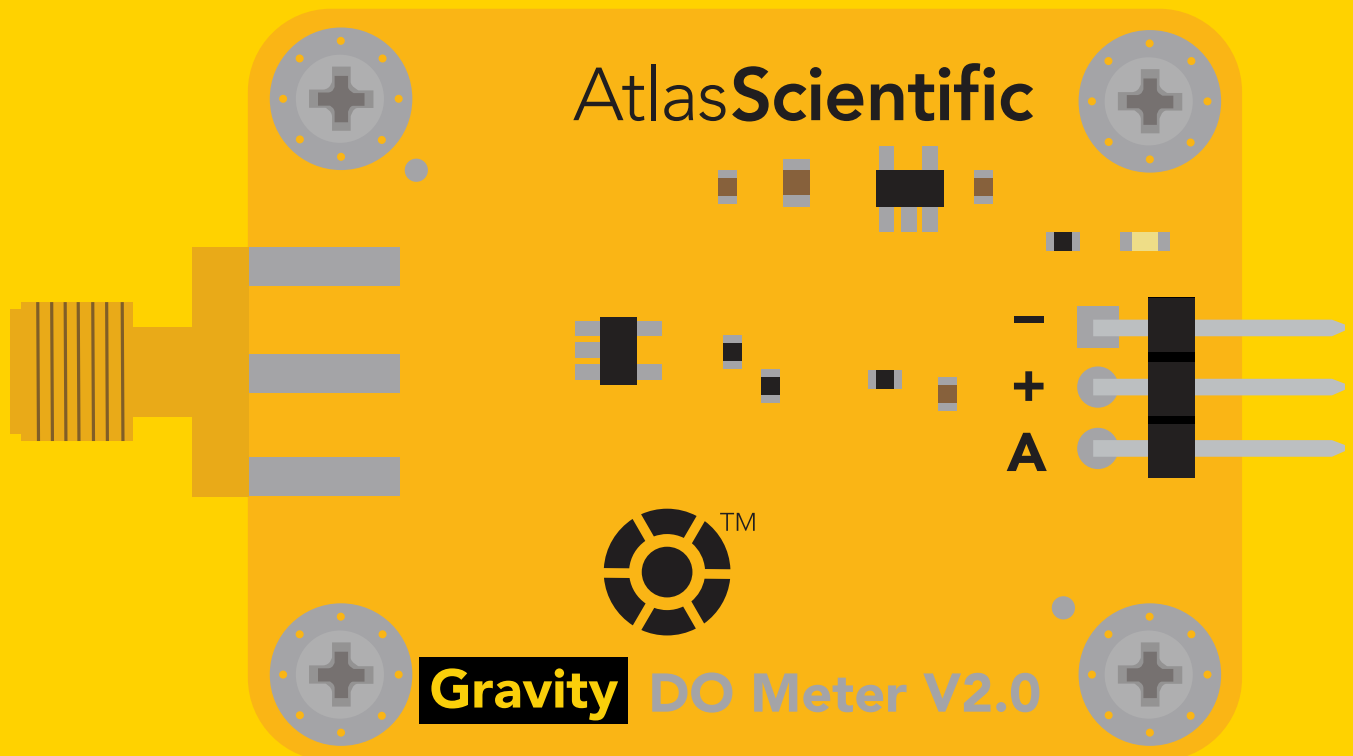

Percent saturation only



PATENT PROTECTED

Gravity dimensions

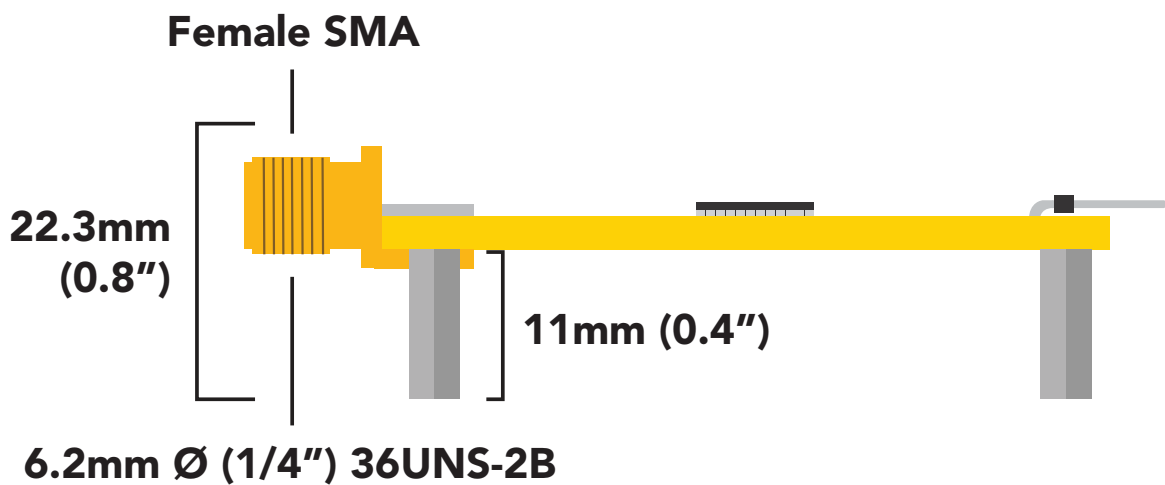
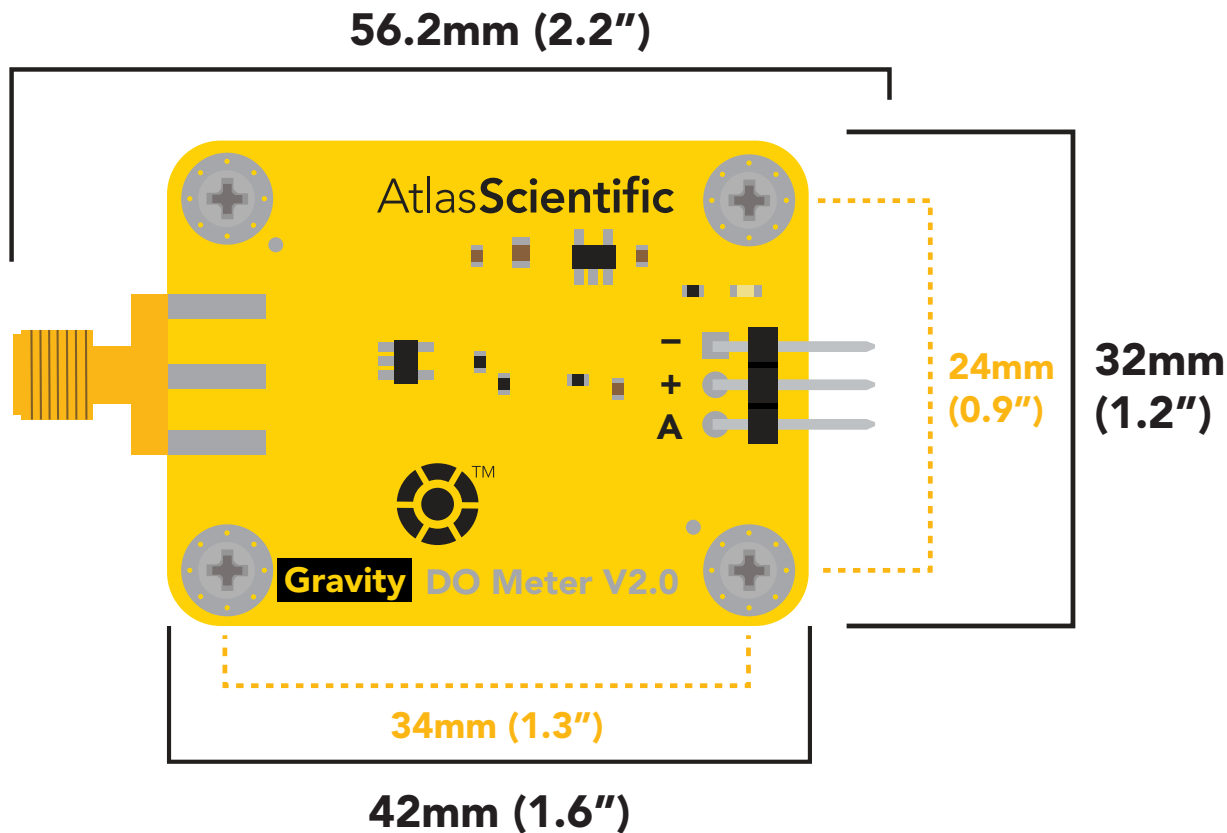

Power consumption

5V = 0.3mA
3.3V = 0.3mA

Absolute max ratings

Parameter	MIN	TYP	MAX
Storage temperature	-65 °C		125 °C
Operational temperature	-40 °C	25 °C	50 °C
VCC	3.3V	5V	5.5V

Operating principle

The Analog Gravity™ class of meters offers the electrical engineer a low-cost solution to traditionally expensive measurements. This device gives the engineer access to the analog front end (AFE) of Atlas Scientific Dissolved Oxygen sensing technology without the added cost that comes with complex mathematical processing.

The Analog Gravity™ Dissolved Oxygen meter has been specially designed to read the voltage coming off a galvanic D.O. probe without damaging the probe; this is done through a combination of high impedance reading and charging events. Where a voltage is read from the probe, and then a voltage is sent to the probe. This back and forth processes dramatically extends the life of the probe from a few months to a few years.

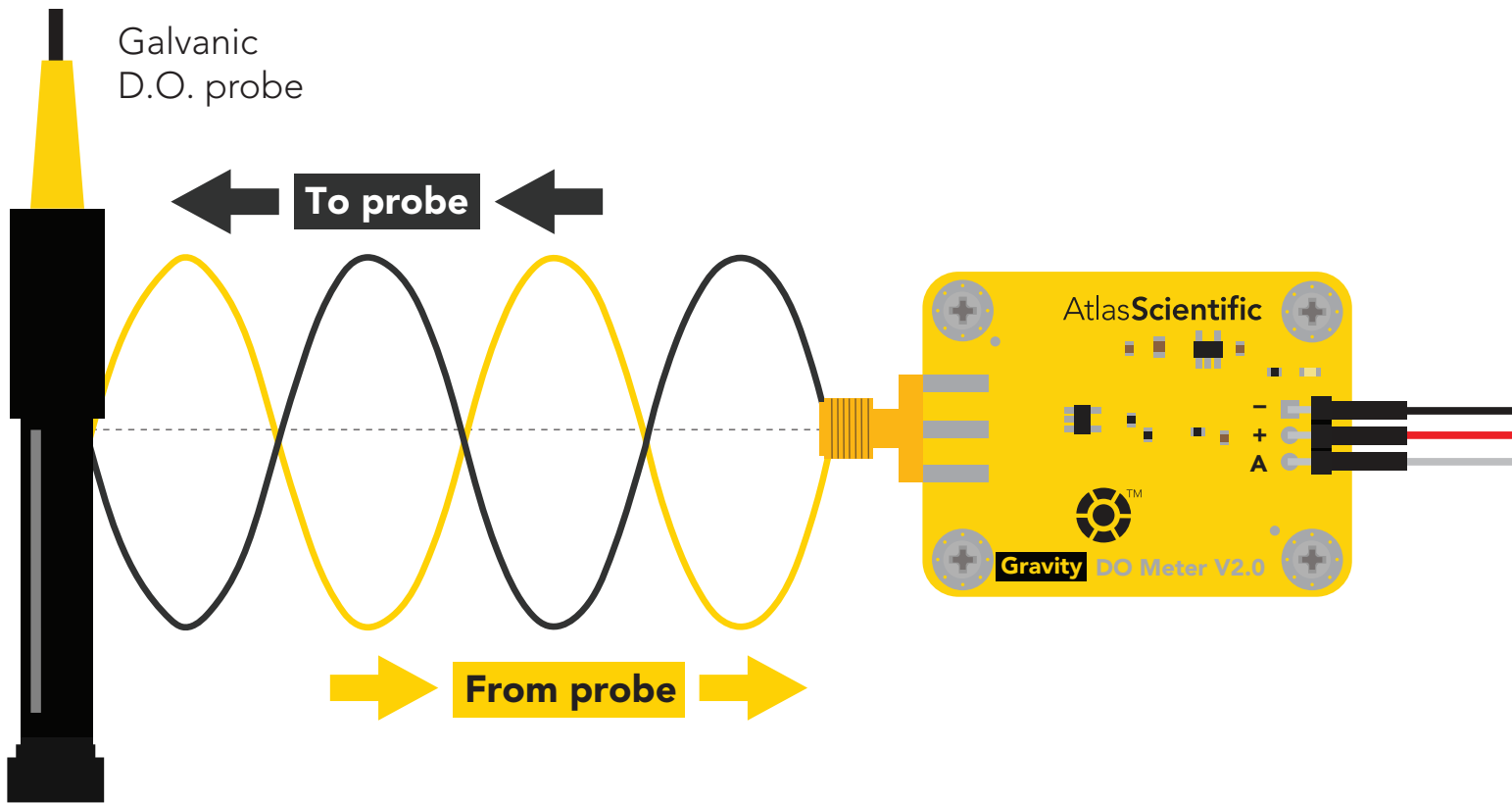

Dissolved oxygen is expressed in two ways:

- 1 Percent saturation (% Sat)
- 2 Milligrams per liter (mg/L)

Reading oxygen levels in mg/L requires very significant mathematical processing and smoothing. Such complex readings can not be done with this device. The Atlas Scientific Analog Gravity™ Dissolved Oxygen Meter *is designed to read percent saturation only.*

Percent saturation

A D.O. probe reads the partial pressure of oxygen. Using the percent saturation method, we can compare the partial pressure of oxygen in the atmosphere to the partial pressure of oxygen in the water and derive some information about its presence in the water. Because a dissolved oxygen probe can only read the partial pressure of oxygen, we are not able to determine the exact O₂ content using this method. However, we can clearly determine its presence and partial pressure.

Max O₂
(100% saturation)

42mV

**Partial
Pressure = 160mmHG**



(90% saturation)

37.8mV

**Partial
Pressure = 144mmHG**



(73% saturation)

30.66mV

**Partial
Pressure = 116.8mmHG**



(47% saturation)

19.74mV

**Partial
Pressure = 75.2mmHG**



Converting the analog signal into percent saturation

Every dissolved oxygen probe will output a slightly different voltage. Atlas Scientific's galvanic dissolved oxygen probe outputs ~40 – 60mV in air.

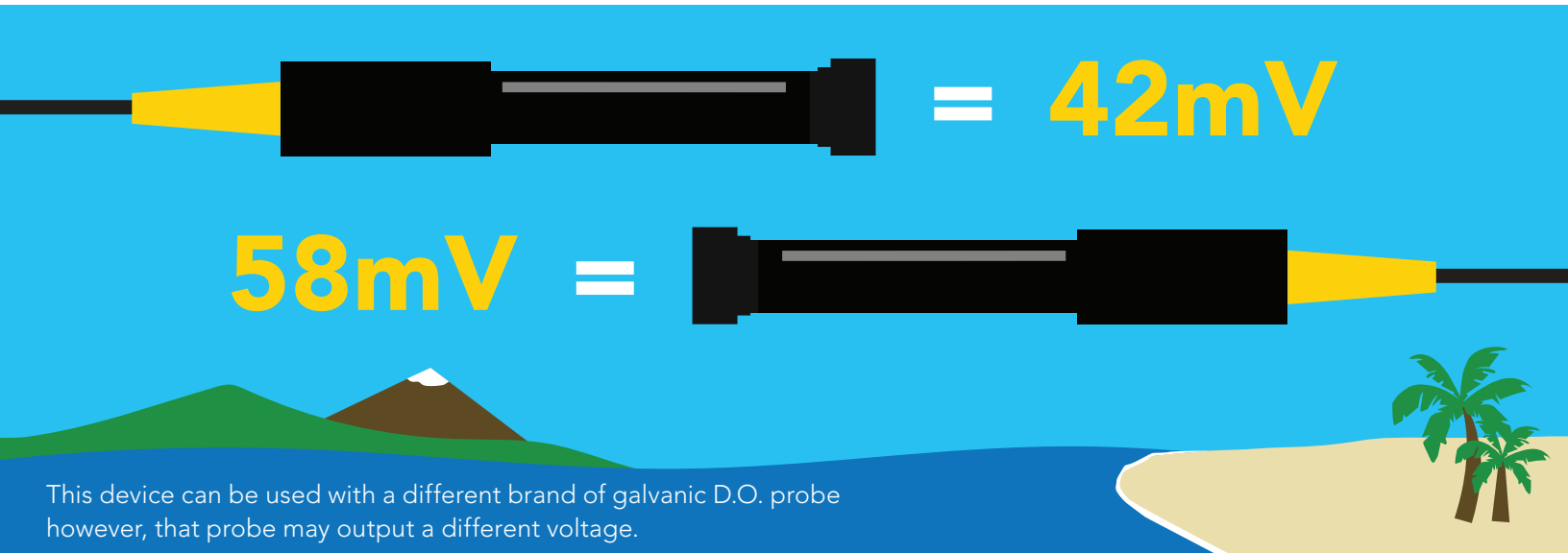

This device can be used with a different brand of galvanic D.O. probe however, that probe may output a different voltage.

The analog voltage coming off **pin A** is the voltage from the probe + an 11x gain. This means the analog voltage read on **pin A** is the voltage from the probe x11.

Example

Probe output	Gravity pin A output
1mV	11mV
42mV	462mV
12.63mV	138.93mV

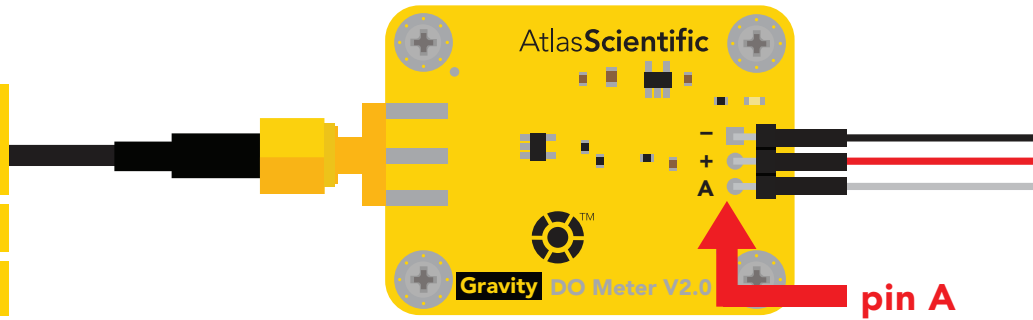

With the probe sitting in the air, watch the voltage coming into your ADC. Wait until the readings stabilize.

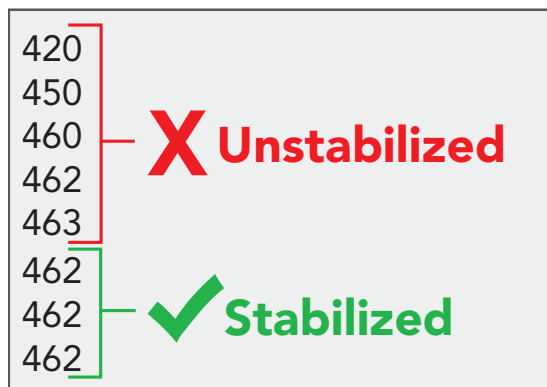

Once the readings stabilize, capture the reading and store it in permanent memory such as EEPROM. This is your calibration value; you don't want to lose it.

Percent Saturation equation

$$\frac{\text{Reading in water}}{\text{Calibration value}} \times 100 = \text{Percent Saturation}$$

Connection pins

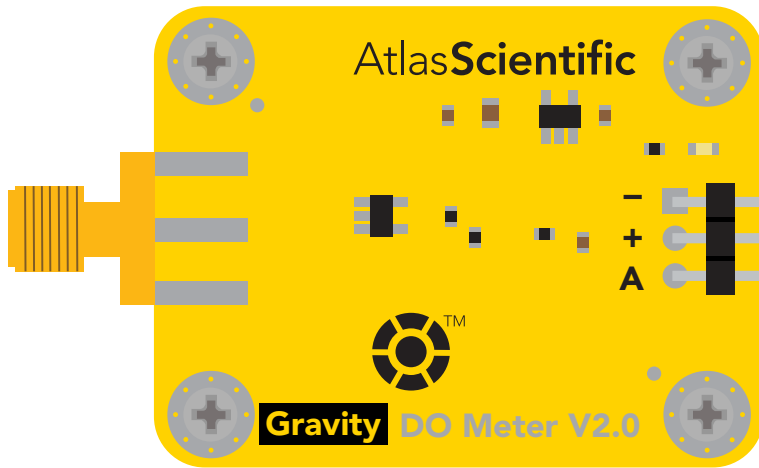

Connect - to GND

Connect + to 3.3V or 5V

Connect to analog pin / ADC

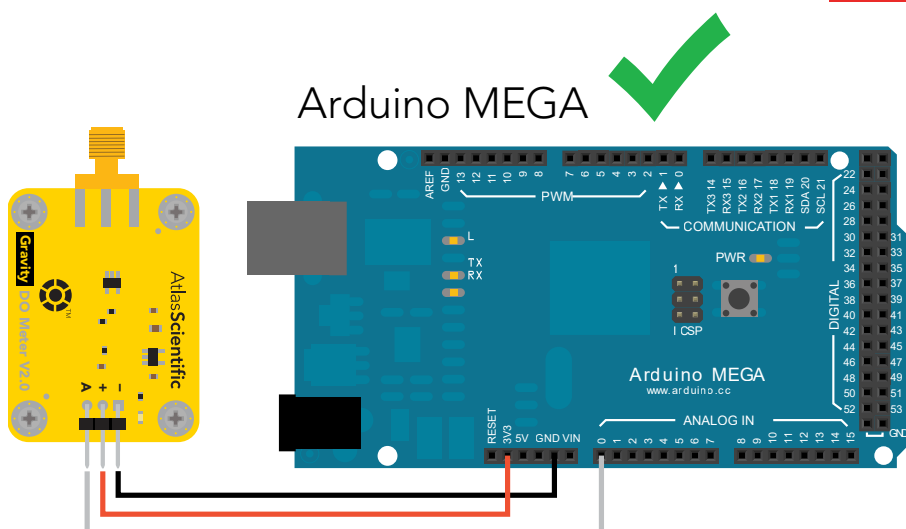
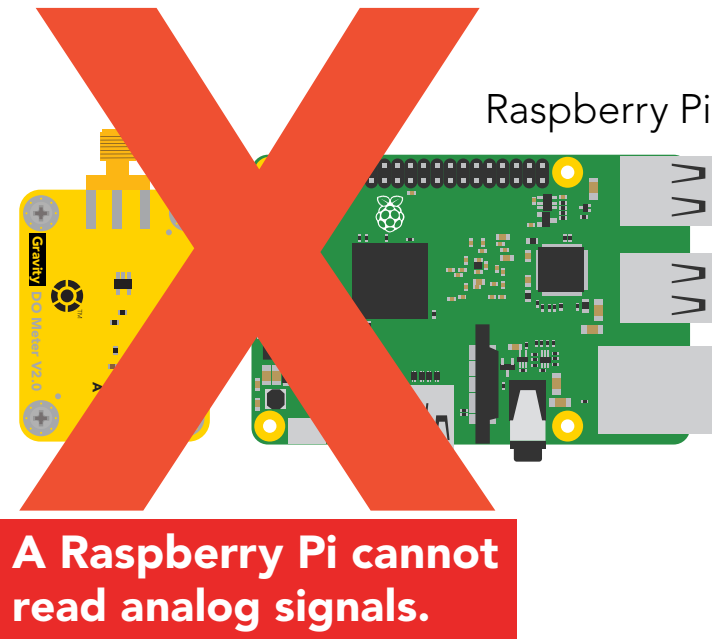
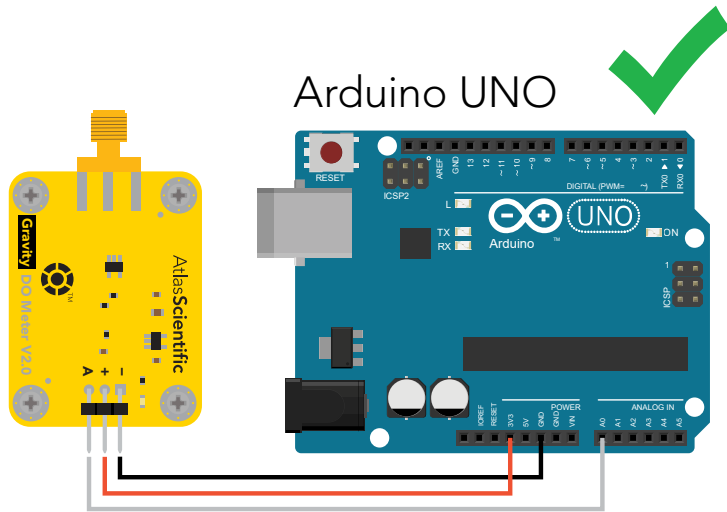

Sample code

Using the [free downloadable arduino sample code](#), a one point calibration can be performed. The calibration procedure does not use any chemical buffer solution, instead you use the open air to calibrate your probe to 100% saturation.

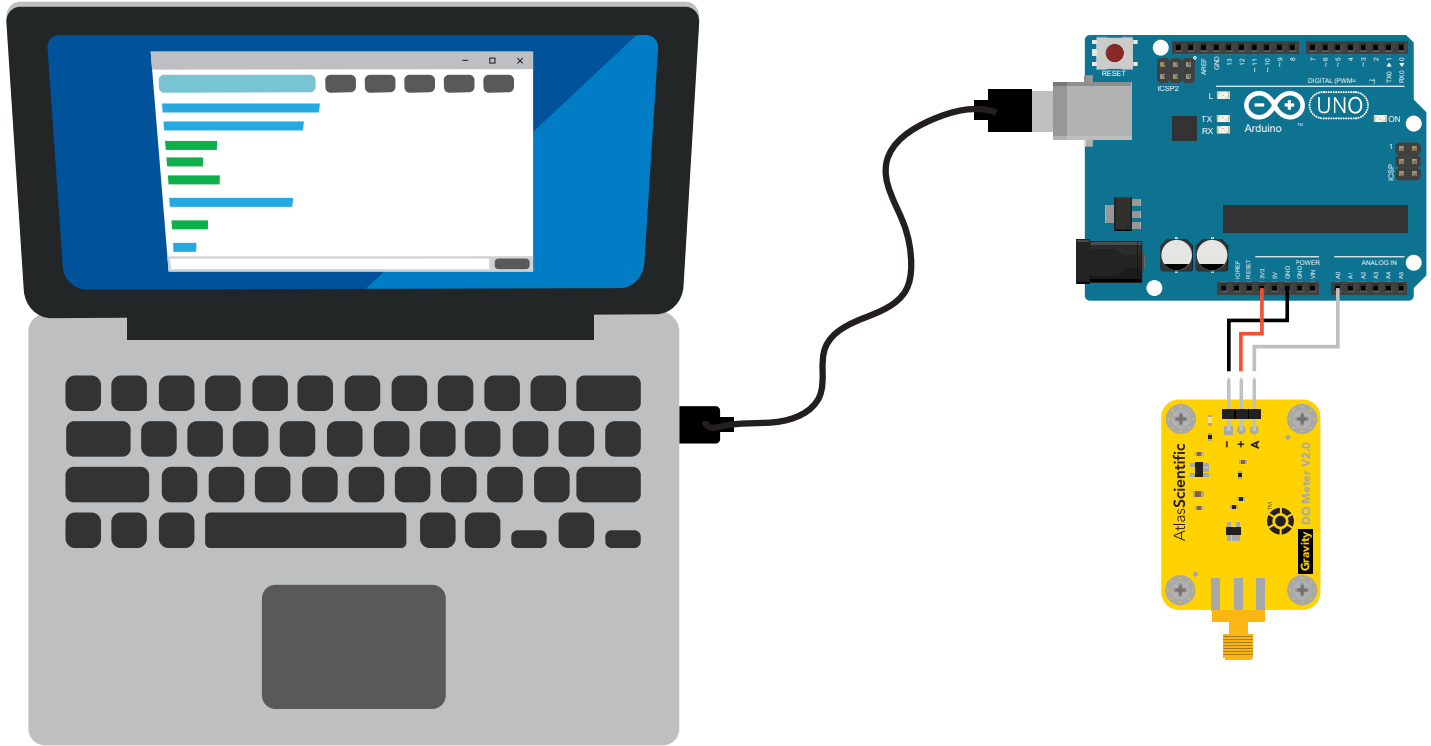

Higher accuracy

If more accuracy is required, Atlas Scientific offers a wide range of embedded D.O. monitoring products that are significantly more accurate than this device.

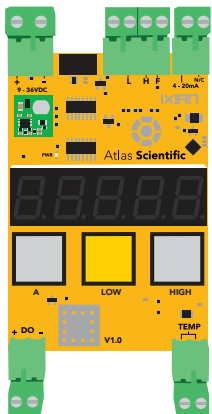

IXIAN-D.O.™
D.O. Transmitter

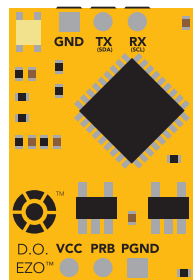

EZO-D.O.™
Embedded D.O. Circuit

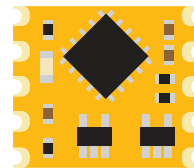

OEM-D.O.™
Embedded D.O. Circuit