

FPΣ (Sigma) Series Programmable Controllers

FPΣ (Sigma)

The next generation compact PLC

Highlights

State-of-the-art PLC technology in the most compact size plus the ability to communicate via all important modern media characterize the FPΣ (Sigma). With its two 100kHz pulse outputs, four high speed counters that function at up to 50kHz for positioning applications, a programming memory capable of storing 32,000 steps, a real-time clock, and communication interfaces for RS232C and RS485, FPΣ (Sigma) is one of the most flexible PLCs on the market. Remarkably, it is also one of the smallest!

Communication

Four quick and easy snap-on cassettes are available to add different serial ports to the FPΣ (Sigma). All ports are capable of communicating at speeds of up to 115.2kbps.

1-channel RS232C type

2-channel RS232C type

1-channel RS485 type

1-channel RS232C + 1-channel RS485 type

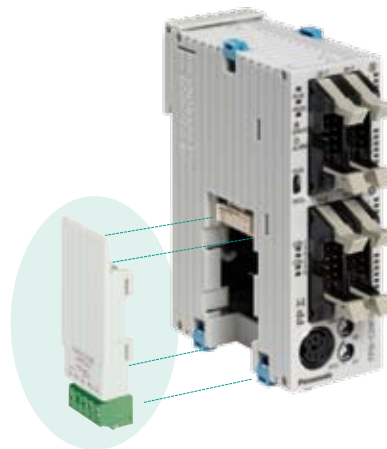

Positioning

In addition to a host of handy Panasonic functions, the FPΣ (Sigma) also offers circular and linear interpolation. Circular interpolation can be used for applications that apply glue, linear interpolation for pick & place applications, for example. By combining the FPΣ (Sigma) with servo motors, you can perform real 2-axis motion control.

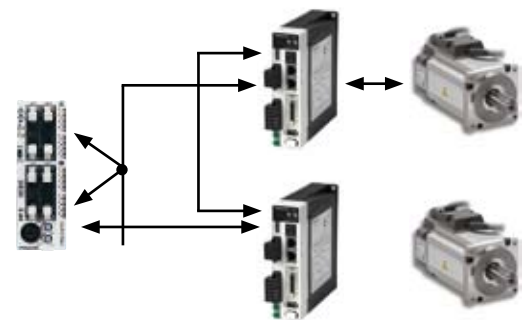

FPΣ (Sigma)

Minus A4 Servo Drives

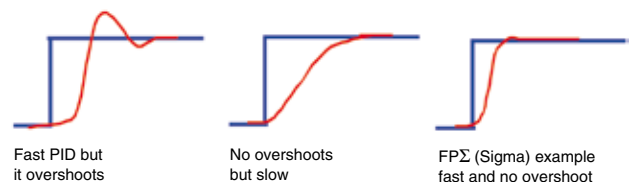

Other highlights

- High expansion capability with up to 384 I/Os
- Fastest processing time, 0.32μsec/basic command
- Compact design [30 x 90 x 60mm (WxHxD)]
- Large data memory of up to 2MByte
- Short circuit protected transistor outputs
- Built-in analog volume with two points
- Backup battery

FPΣ (Sigma) CPUs

Outstanding performance in a compact design

FPΣ (Sigma) – Transistor output type



28 points
 Input 16 points Output (PNP) 12 points
 Connector type
 FPG-C28P2H-A



32 points
 Input 16 points Output (NPN) 16 points
 Connector type
 FPG-C32T2H-A

FPΣ (Sigma) Relay output type



24 points
 Input 16 points Output 8 points
 Terminal type
 FPG-C24R2H-A

FPΣ (Sigma) – Transistor output type with thermistor input



28 points
 Input 16 points Output 12 points
 2 Thermistor inputs
 FPG-C28P2HTM



32 points
 Input 16 points Output 16 points
 2 Thermistor inputs
 FPG-C32T2HTM

FPΣ (Sigma) – Relay output type with thermistor input



24 points
 Input 16 points Output 8 points
 2 Thermistor inputs
 FPG-C24R2HTM

Temperature control

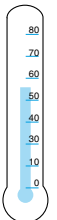

High expansion capability

FPΣ (Sigma) can use the expansion units of the FP0 on the right-hand side. New FPΣ (Sigma) units can be added to the left-hand side.

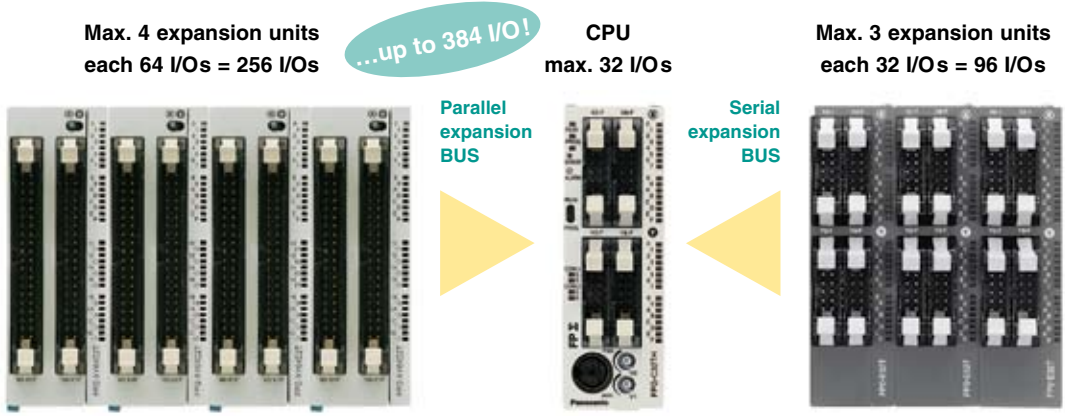

FPΣ (Sigma) expansion units – left side

Wide variety of expansion units

**FPΣ (Sigma)
I/O expansion unit**



64 points	
Input 32 points	Output (PNP) 32 points
MIL connector type FPG-XY64D2P-A	

**FPΣ (Sigma)
I/O expansion unit**



64 points	
Input 32 points	Output (NPN) 32 points
MIL connector type FPG-XY64D2T-A	

**FPΣ (Sigma)
Memory expansion unit**



FPG-EM1
Memory: 256k words FPG-EM1

FPΣ (Sigma) positioning expansion units RTEX Real-time Ethernet system for Minus A4N servo drives



2-axis
FPG-PN2AN



4-axis
FPG-PN4AN



8-axis
FPG-PN8AN

FPΣ (Sigma) positioning expansion units



1-axis
Transistor output
FPG-PP11



1-axis
Line driver output
FPG-PP12



2-axis
Transistor output
FPG-PP21



2-axis
Line driver output
FPG-PP22

FPΣ (Sigma) expansion units – left side

Wide variety of expansion units

**FPΣ (Sigma)
PROFIBUS expansion unit**



PROFIBUS Master
FPG-DPV1-M

**FPΣ (Sigma)
CANopen expansion unit**



CANopen Master
FPG-CAN-M

**FPΣ (Sigma)
DeviceNet expansion unit**



DeviceNet Master
FPG-DEV-M

**FPΣ (Sigma)
S-Link expansion unit**



S-Link Master
FPG-SL

**FPΣ (Sigma)
FNS (Flexible Network Slave) unit**



Flexible Network Slave
FPG-FNS

**Network plug-in modules for
FPΣ (Sigma) FNS unit**



PROFIBUS
Plug-in module
AFPN-AB6200

DeviceNet
Plug-in module
AFPN-AB6201

CANopen
Plug-in module
AFPN-AB6218

**FPΣ (Sigma)
CC-Link slave expansion unit**



CC-Link Slave
FPG-CCLS

Communication cassettes



1-channel RS232C type
FPG-COM1
5-wire



2-channel RS232C type
FPG-COM2
3-wire



1-channel RS485 type
FPG-COM3
2-wire



**1-channel RS232C type
+ 1-channel RS485 type**
FPG-COM4
2-wire

FP memory loader

- Read or write programs from or into a PLC
- Personal computer is not required
- Applicable with FP0, FPΣ (Sigma), FP-X, FP2 and FP2SH



AFP8670 Data clear type
AFP8671 Data hold type

FPΣ (Sigma) expansion units – right side

Wide variety of expansion units

A maximum of 3 FP0 expansion units can be added to the FPΣ (Sigma) CPU unit.

Digital I/O units

Relay output type



8 points	
Input 4 points	Output 4 points
FP0-E8RSA	



16 points	
Input 8 points	Output 8 points
FP0-E16RSA	



32 points	
Input 16 points	Output 16 points
FP0-E32RS	

Input only type



8 points	
Input 8 points	
FP0-E8XA	



16 points	
Input 16 points	
FP0-E16XA	

Transistor output type



8 points	
Output 8 points	
FP0-E8YPA (PNP)	
FP0-E8YTA (NPN)	



16 points	
Input 8 points	Output 8 points
FP0-E16PA (PNP)	
FP0-E16TA (NPN)	



16 points	
Output 16 points	
FP0-E16YPA (PNP)	
FP0-E16YTA (NPN)	



32 points	
Input 16 points	Output 16 points
FP0-E32PA (PNP)	
FP0-E32TA (NPN)	

Option:

Output 8 points
FP0-E8YRSA

Analog I/O units



3 points	
Input 2 points	Output 1 point
FP0-A21A	



4 points	
Output 4 points	
FP0-A04I	



4 points	
Output 4 points	
FP0-A04V	



8 points	
Input 8 points	
FP0-A80A	

- Input (12bit): ±10V, 0–5V, 0–20mA
 - Output (12bit): ±10V, 0–20mA
- | | | | |
|---|--------|------|--------------|
| – | – | – | ±10V, ±100mV |
| – | – | – | 0–5V, 0–20mA |
| – | 4–20mA | ±10V | |

Temperature control units



4 points	
Input 4 points	
FP0-TC4	



8 points	
Input 8 points	
FP0-TC8	



6 points	
Input 6 points	
FP0-RTD6	

- K, J, T, R type thermocouples can be used
 - Resolution: 0.1°C
 - Accuracy: 0.8°C (R type: 3°C)
 - Temperature range: -100 to 1500°C
- Pt100, Pt1000, Ni1000
 - Temperature range: -200 to 500°C

AC power supply



Input 85 to 265VAC	Output 24VDC/0,7A
Terminal type	
FP0PSA2	



Input 85 to 265VAC	Output 24VDC/2,1A
Terminal type	
FP0PS24050ED	

Networking units



MEWNET-F
FP0-IOL
(MEWNET-F Slave)



PROFIBUS
FP0-DPS2
(DP Slave) or
Remote I/O



Ethernet
FPWEB2
(Web-Server unit)

FPΣ (Sigma)

Optimized communication function

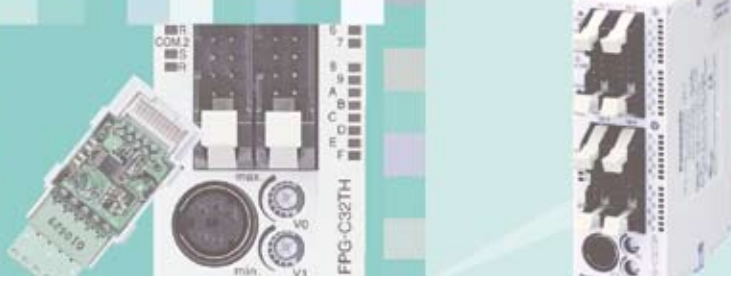

1-channel RS232C type FPG-COM1

2-channel RS232C type FPG-COM2

1-channel RS485 type FPG-COM3

1-channel RS232C + 1-channel RS485 type FPG-COM4

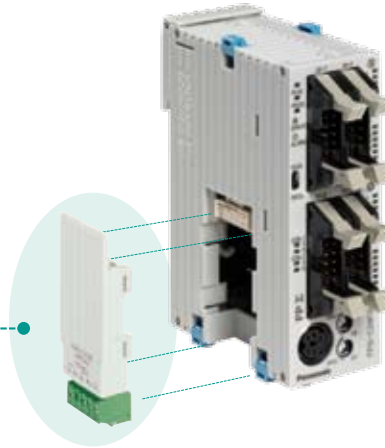

Four types of communication cassettes enable:

- Efficient connection to serial devices.
- Transmission speeds of up to 115.2kbits/s.
- Long transmission distance of up to 1200m.
- In addition, the green screw terminal is removable for easy wiring.

With the RS232C type communications cassette:

Efficient connection with other control devices helps to save space!

- Enables connection to devices with RS232C interface, such as a programmable display panel, image processing device and other devices.
- When used as a tool port, up to 3 external devices can be connected.
- A 2-channel type communication cassette is used.

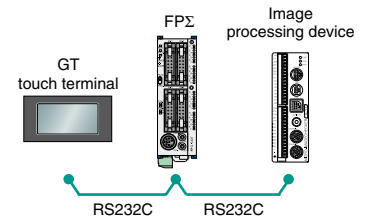

With the RS485 type communication cassette:

More links than you imagined a compact PLC could achieve (2048 link relays / 256-word link data registers)

- Can be used to share product type data between different machines.
- Can be used for interlocking between different machines.
- Easy wiring between PLCs with twin-core cabling.

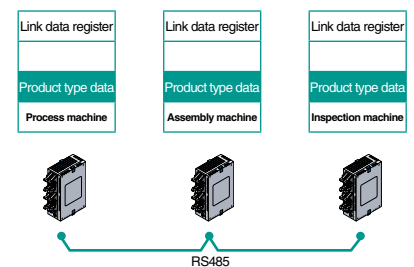

Masterless communication using the FPΣ (Sigma)

- Even if a station goes into a power-off state, communications between the other stations continue. The failed station can be integrated quickly and smoothly into the network in the event of recurrence.



Connection to external devices using RS485 interface

- Enables connection to external devices, such as temperature controllers or Eco Power Meter, that are equipped with RS485 interface.
- Transmission speed: Max. 115.2kbits/s.
- Transmission distance: Max. 1200m.
- Control is possible using commercially available RS485 devices.

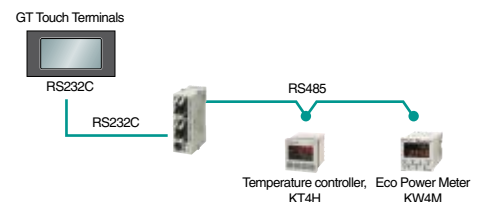

FPΣ (Sigma) positioning

Specially designed for positioning applications

Max. 100kHz pulse output performance is now standard.

Powerful device capable of linear interpolation and circular interpolation.

Pulse output max. 100kHz

Because command processing at speeds up to 100kHz is available, high-speed, high-precision positioning is enabled. Along with stepping motor control, the specs also ensure plenty of scope for controlling servo motors.

Possible to combine with pulse-train input drivers
Single unit enables two-axis control

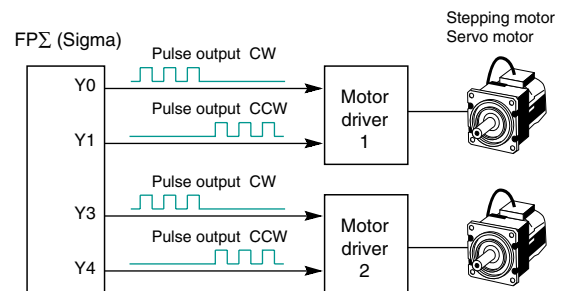

Rapid 0.02ms start (when JOG operation controls are executed)

The time taken to execute the JOG operation, from the instant the trigger (execution condition) goes on to the time of pulse output, is 0.02ms and 0.2ms even with trapezoidal control. Control time is reduced even for machines that quickly and repeatedly restart.

Linear interpolation and circular interpolation are built in (FPG-C32T2H-A and FPG-C28P2H-A)

Interpolation functions enable simultaneous control of two axes. Applications that a compact PLC couldn't previously cope with are no longer a challenge.

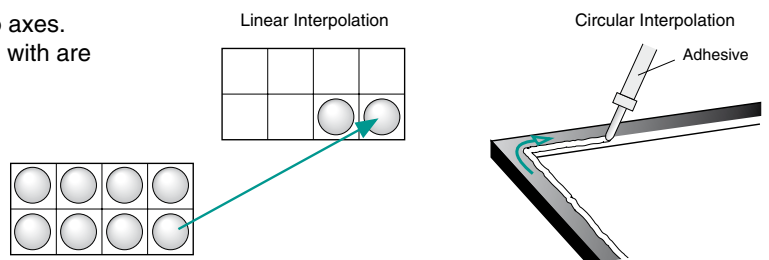

And there's more:

Smooth acceleration/deceleration

You can choose to set either 30 or 60 steps of acceleration/deceleration. This feature means you can achieve smoother movement during long acceleration/ deceleration periods of stepping motors.

The settings are there for a maximum 60 acceleration/ deceleration steps.

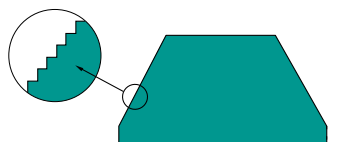

Support for CW/CCW method

Reduce overall costs by designing systems that combine with servo motors and small stepping motors without support for Pulse and Sign method.

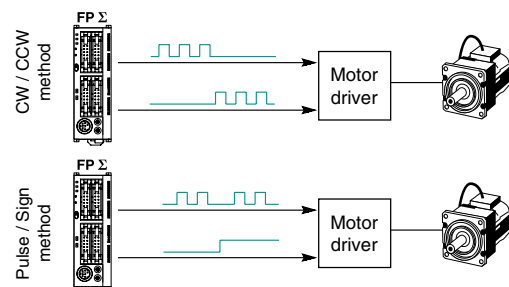

FPΣ (Sigma) positioning

High-speed, high precision positioning

Programming with convenient and easy-to-understand instructions

- Uses a preset value table for starting speed, target speed, acceleration/deceleration time, and other factors. Easy-to-understand programming is possible since numbers can be specified intuitively.
- Comes with dedicated instructions for each mode: trapezoidal control, home return, JOG operation, free table operation, linear interpolation, and circular interpolation.

Selectable home return mode

- The home return method may be specified even in situations such as when only a single sensor is being used, depending on the design.
- When the home position return is completed, a deviation counter clear signal can also be output.

Home position return

- Pulse output diagram (when the home position proximity input is not used).

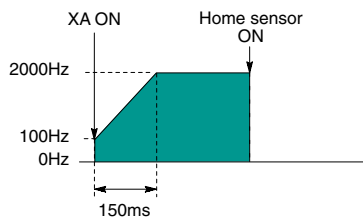

Home search automatically reverses the motor rotation when Over limit input(+) or Over limit input (-) is input and their searches for the home position or near home position in order to return to it automatically.

JOG operation

- Pulse output diagram.

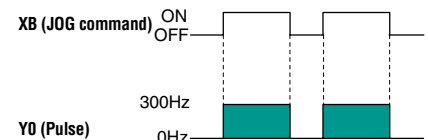

This refers to an operation in which the motor is rotated only while operation commands are being input. This is used to forcibly rotate the motor using input from an external switch, for instance when making adjustments. Depending on the circumstances, unlimited feeding can be accomplished with the JOG operation in some cases.

Linear interpolation

- Positioning locus.

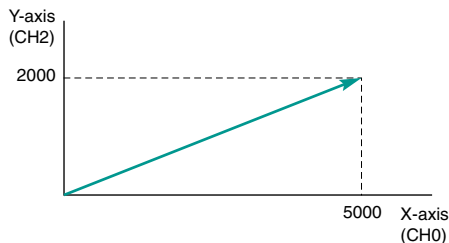

A control function that automatically defines the continuum of points in a straight line based on only two coordinate positions.

Circular interpolation

- Positioning locus.
- Center-radial setting methods are also available.

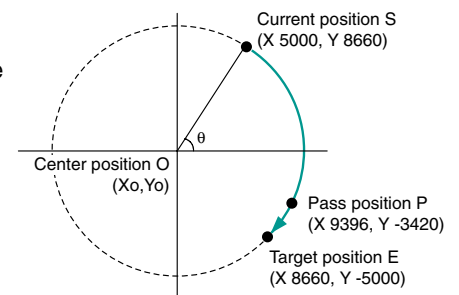

Allows points to be smoothly traversed by arced paths for which the user specifies the orientation plane, the radius of curvature, motion path profile and direction of motion.

FPΣ (Sigma) positioning expansion units

Precise positioning

Features

- Fast startup of 0.02 or 0.005ms makes cycle time reduction possible.
- Feedback pulse count function makes output pulse counting from external encoders possible.
- JOG positioning control supports a wide range of applications.
- 4 types of S-curve acceleration/deceleration control makes smooth startup and stopping possible: Sine curve, quadratic curve, cycloid curve and cubic curve.



FPG-PP11



FPG-PP12



FPG-PP21

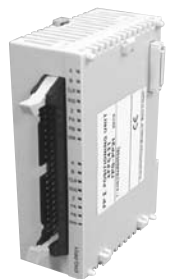

FPG-PP22

- The FPΣ (Sigma) positioning unit can handle simultaneous startup of multiple axes, enabling simultaneous control of linear interpolation and other elements through user programs.
- Transistor output type (open collector) and line driver output type are available.

Unit type and product number		
Type	Output type	Part number
1-axis type	Transistor output type	FPG-PP11
2-axis type	Transistor output type	FPG-PP21
1-axis type	Line driver output type	FPG-PP12
2-axis type	Line driver output type	FPG-PP22

Positioning control using a stepping motor

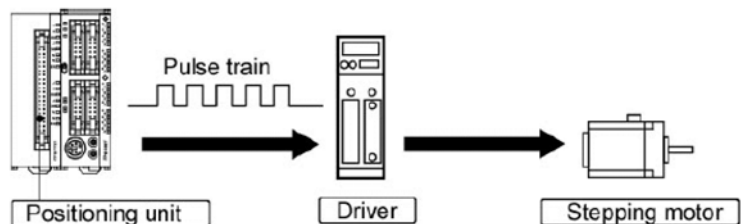

Positioning control using a servo motor

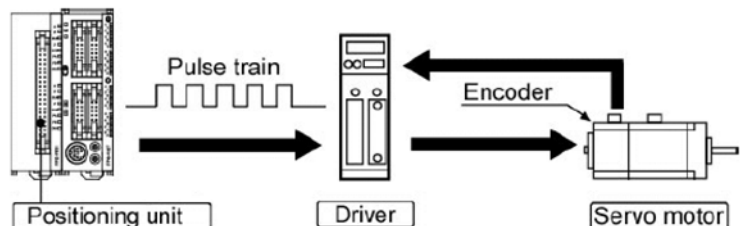

1-axis and 2-axis types are available.
Multiple axes (up to 2 axes) can be controlled with a single unit.

FPΣ (Sigma) RTEX expansion units

RTEX multi-axis network servo system

The RTEX positioning units support Minus A4N network servo drives. A mutually optimized system consisting of PLC and servo drive greatly simplifies installation.

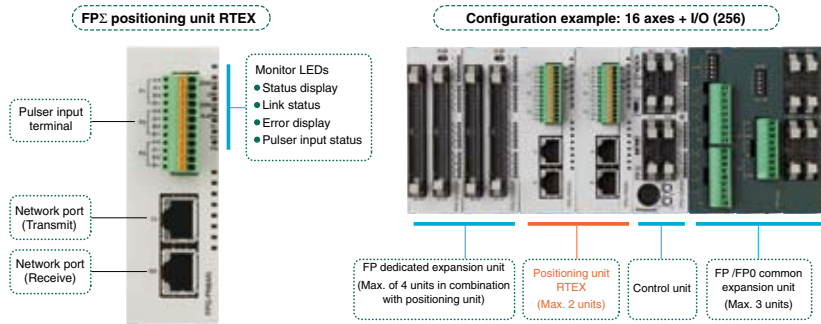

System configuration:

- Maximum number of control axes: 16 axes. Realization of highly accurate 2-axis circular interpolation, 3-axis linear interpolation and 3-axis spiral interpolation with high-speed 100Mbps communication.
- With 3 types in the product range, for 2 axes, 4 axes and 8 axes, provides flexible support even for control of small numbers of axes.
- By using loop wiring Realtime Express* provides high reliability by creating smooth communication conditions with the data flow always in the same direction.

* Matsushita Electric Industrial network servo systems

Specifications:

		2-axis type	4-axis type	8-axis type	
Part number FPΣ (Sigma) / FP2		FPG-PN2AN	FPG-PN4AN	FPG-PN8AN	
Unit specifications	Positioning control functions	Control method			
		PTP Control, Cursor Path (CP) Control			
		Interpolation control			
		2-axis/3-axis linear interpolation, 2-axis circular interpolation, 3-axis spiral interpolation			
		Control units			
		Pulse/μm/inch/degree			
		Position data			
	600 points for each axis				
	Backup		Parameters and data file can be saved to FROM		
	Acceleration/deceleration method		Linear acceleration/deceleration/S-curve acceleration/deceleration		
Acceleration/deceleration time		0 to 10,000ms (1ms units) different settings for acceleration and deceleration are possible			
Positioning area		(-1,073,741,823 to 1,073,741,823 pulse) increment and absolute specification			
Speed control functions		Supported with JOG operation (free run operation)			
Origin functions	Search method	Origin proximity (DOG) search			
	Creep speed	Free settings possible			
Other functions	Pulsar input operation support				
	Auxiliary output code, auxiliary output contact support				
	Dwell time support				
Communication specifications	Communication speed	100Mbps			
	Cable	Commercially available LAN straight cable (shielded category 5e)			
	Connection method	Ring method			
	Communication cycle/no. of terminals	0.5ms; max. 8 axes/system (command cycle: 1ms)			
	Transmission distance	Between terminals: 60m; total length: 200m			

Optimized temperature control

Functions convenient for temperature control are built in

The control unit with thermistor inputs enables temperature control at low cost

Two thermistor inputs, which cost less than thermocouples, can be connected to the FPΣ (Sigma) unit via thermistor inputs (FPG-C28P2HTM, FPG-C32T2HTM and FPG-C24R2HTM).

FPΣ (Sigma) control unit that accepts thermistors

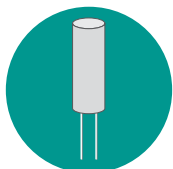

Thermistor



Using a simple linearization command, measuring the temperature by the thermistor can be programmed easily.

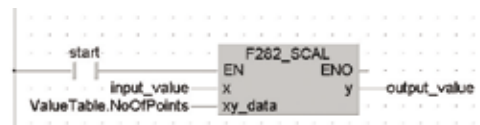

Value	Description
10	No. of reference points
110	1 st reference x point
120	2 nd reference x point
•	•
•	•
80	1 st reference y point
95	2 nd reference y point
•	•
•	•

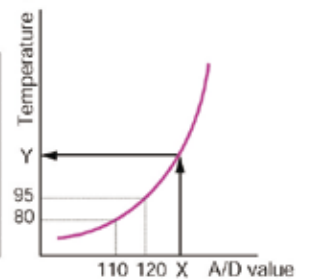

Four- and eight-channel type thermocouple input expansion unit

Up to three units can be added to each control unit, enabling temperature control of up to 24 channels.

Advantages over multiple temperature controllers:

- Information collection and computer-based storage.
- On-site error monitoring using programmable display.
- Significant reduction in total costs.
- Power supply stabilisation by protecting synchronisation between heater ON and OFF states.
- Temperature settings can be easily changed using batch function.

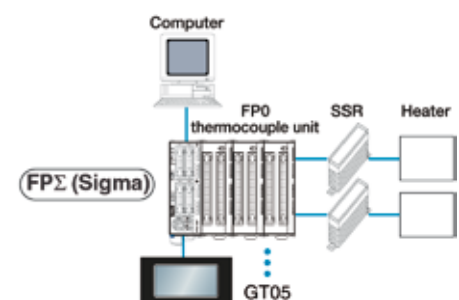

Optimized temperature control with PID and PWM instruction

You can easily set multi-stage temperature control and time control usually available only in high performance type temperature controllers.

Various FPWIN Pro libraries simplify the programming of closed loop controlled electrical installations and consequently save valuable human resource costs. The process and temperature control Library NCL-PTC-LIB, for example, includes linear and non-linear controller types such as the P/I/PI/PID controller and two-point / three-point controllers with and without hysteresis. Functions for dead band, interpolation, ramp limiting, dead time and averaging are also included.

Example of temperature control with the auto-tuning function only

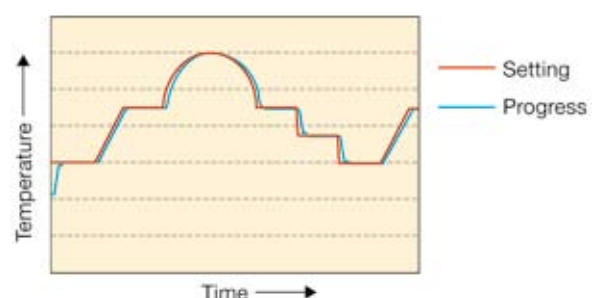

FPΣ (Sigma) data memory expansion unit

Data capacity expandable up to 256k words

Features

- Able to store 256k words, this memory unit is well-suited for storing remote monitoring logs.
- Take advantage of FPΣ's (Sigma) memory for manufacturing systems that produce more than one model. With FPΣ's (Sigma) memory, you no longer need to download new production data every time you switch manufacturing process.
- Up to 4 units can be connected to the FPΣ (Sigma), allowing up to 1024k words to be stored.



FPG-EM1

General specifications

Item	Description
Ambient temperature/humidity	0 to 55°C, 30 to 85% RH (no condensation)
Storage temperature/humidity	-20 to +70°C, 30 to 85% RH (no condensation)
Vibration resistance	10 to 55Hz, 1 sweep/min., double amplitude of 0.75mm, 10min. on 3 axes
Shock resistance	98m/s ² or more, 4 times on 3 axes
Noise immunity	1000V (P-P) with pulse width 50ns, 1μs (using a noise simulator)
Basic unit mass	Approx. 80g
The amount of increase in control unit consumption current	35mA or less (24VDC) (100mA or less (internal 5VDC))

Performance specifications

Item	Description
Memory capacity	256k words (1k words x 256 banks)
Battery life	5 years or more
5V Power consumption	10 to 55Hz, 1 sweep/min., double amplitude of 100mA or less
Number of I/O points	Input 16 points

Programming tool FPWIN Pro

Instructions F150 and F151 are necessary for reading from and writing to memory expansion units.

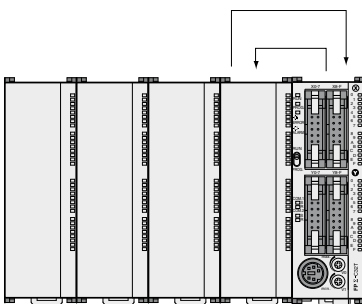

Data is read with the F150 instruction.

Data is written with the F151 instruction.



FPΣ (Sigma) Flexible Network Slave units

Powerful, modular network units

The Flexible Network Slave (FNS) units are powerful, modular network units used together with the programmable controllers FPΣ (Sigma). By exchanging compact network blocks, you can connect to various networking systems without having to modify your entire hardware platform. The blocks are available for three bus systems: PROFIBUS, DeviceNet and CANopen. Others are planned for the future.

Flexible Plug-In Network modules The world's first in a PLC



FPG-FNS



PROFIBUS
Plug-in module
AFPN-AB6200

DeviceNet
Plug-in module
AFPN-AB6201

CANopen
Plug-in module
AFPN-AB6218

No special tools are required for mounting. You can mount the blocks in the device at any phase between manufacturer and end customer without having to worry about special protective provisions.

Advantages:

- Wide range of connectivity solutions for FPΣ (Sigma) and FP2/FP2SH.
- One PLC hardware platform for several bus systems.
- Fast reaction on new market trends possible with existing units.
No additional hardware development needed. You need only to exchange the network block.
- Very small and compact size.

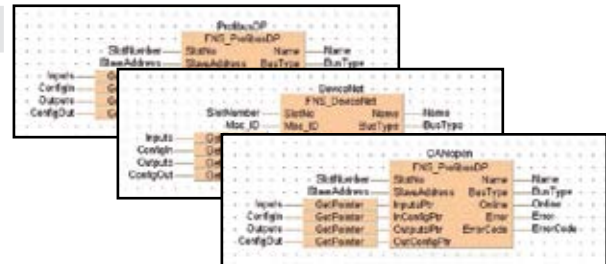

For each network type ready-made function libraries are available for the programming software FPGWIN Pro, which can be downloaded from Panasonic Electric Works' internet homepage. These libraries will drastically shorten the time needed to develop your applications and consequently save valuable human resource costs. They also include a complete online help file and programming examples. In addition, you need the GSD or EDS files which describe how the slave modules communicate with the master module. Also these can be downloaded from the same internet homepage.

FNS (Flexible Network Slave) specifications:

Item	PROFIBUS	DeviceNet	CANopen
Baud rate	Automatic baud rate detection		
	9.6kbaud to 12Mbaud	125kbps to 500kbps	10kbps to 1Mbps
Isolation	Galvanically isolated bus electronics		
Connection types	DP-V0: process data is accessed from the PROFIBUS network as cyclical I/O data	<ul style="list-style-type: none"> • Cyclic connections • COS (Change of State) • Bit strobe connections • Polled connections • Explicit connections 	PDO (Process Data Object) exchange via: <ul style="list-style-type: none"> • Cyclic synchronous • Acyclic synchronous • COS • Timer-driven connections
Maximum inputs/ outputs	76 words altogether for inputs and outputs (in units of 1.2 or 4 words)	E.g. for cyclic connections: 128 words in each direction	128 words (for TPDOs and RPDOs)
Additional features	Diagnostic support	<ul style="list-style-type: none"> • UCMM capable • CIP parameter object • Diagnostic support 	Diagnostic support
Interface	DB9F (9-pin D-Sub female)	5-pin terminal block	DB9M (9-pin D-sub male)



Free download for FNS-related files:
www.panasonic-electric-works.com

FPΣ (Sigma) Fieldbus Master Units

The optimal network solution for your facility

The expansion Fieldbus Master Units (FMU) allow you to integrate FPΣ (Sigma) PLCs into your network with a maximum degree of flexibility. The units are available for three bus systems: PROFIBUS, DeviceNet and CANopen. Others are planned for the future.



FPΣ FMU PROFIBUS:
FPG-DPV1-M



FPΣ FMU DeviceNet:
FPG-DEV-M



FPΣ FMU CANopen:
FPG-CAN-M

Advantages:

- Wide range of connectivity solutions for FPΣ (Sigma).
- One PLC hardware platform for several bus systems.
- Gateway function between Fieldbus types simply by connecting the corresponding expansion units to the same CPU.
- One configuration software for various Fieldbus systems:
 - one-time cost, several network types,
 - only one installation necessary,
 - user must only be trained to use one software.
- The configuration software is integrated in the PLC programming software Control FPWIN Pro:
 - no additional software required on the PC,
 - bus-relevant global variables are automatically generated for the PLC program
- Fieldbus Master Units (FMU) Library for PROFIBUS, DeviceNet and CANopen can be downloaded free of charge from Panasonic Electric Works' internet homepage.

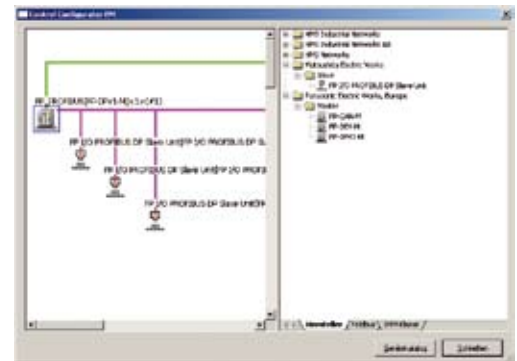

Control Configurator FM is an add-on software for Control FPWIN Pro and is used to configure and diagnose the FMUs. Part number: AFPS35510

FMU (Fieldbus Master Unit) specifications:

Technical data	PROFIBUS DP	DeviceNet	CANopen
Bustype	RS485	CAN / ISO 11898	
Number of slaves	125	63	126
Number of process data	3584 bytes for inputs and 3584 bytes for outputs		
Bus length	100m (12Mbit/s) 200m (1.5Mbit/s) 400m (500kbit/s) 1km (187.5kbit/s)	100m (500kbit/s) 250m (250kbit/s) 500m (100kbit/s)	40m (1Mbit/s) 500m (100kbit/s)
Connection types	DP-V0: process data is accessed from the PROFIBUS network as cyclical I/O data	<ul style="list-style-type: none"> • Cyclic connections • COS (Change of State) • Bit strobe connections • Polled connections • Explicit connections 	PDO (Process Data Object) Exchange via: <ul style="list-style-type: none"> • Cyclic synchronous • Acyclic synchronous • COS • Timer-driven connections
Internal current consumption	450mA	150mA	450mA
Connector type	DB9F (9-pin D-Sub female)	5-pin terminal block	DB9M (9-pin D-Sub male)
Weight	95g		

FPΣ (Sigma) S-Link expansion unit

Flexible wire-saving link system S-Link

Features

- Up to four S-Link units can be attached to one FPΣ (Sigma) CPU.
- Each unit supports up to 128 I/O signals over a pair of wires up to a distance of 200m (400m when a booster is used).
- The combination of input and output point quantities (a total of 128 points max.) can be set by the rotary switch in increments of 32 points.
- The transmission line connection is realized via a T-branch multi-drop wiring with hook-up connectors. Adding devices is rendered easy and maintenance is easy.



FPG-SL

FPΣ (Sigma) + S-Link unit

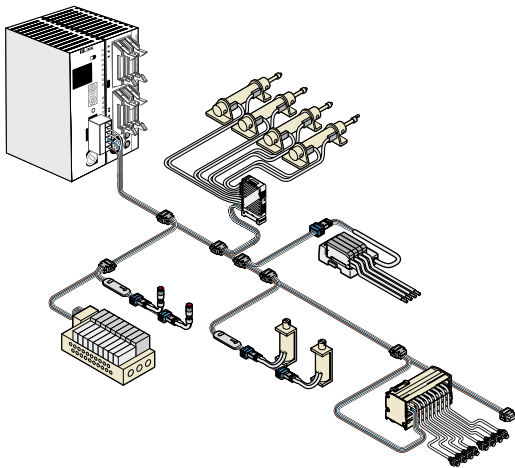

Features

- The four-wire cable (two signal wires and two power wires) enables efficient wiring, and the T-branch wiring enables a flexible connection layout.
- About 60 types of S-Link input/output devices can be connected to this unit, enabling it to meet diverse I/O needs. In addition, the high transmission voltage (24VDC) and the wide clock width (35μs) provide high noise immunity. Flexible and reliable wiring is available, reducing the wiring work.

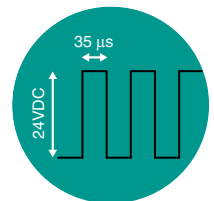

Features

- The control unit automatically recognizes I/O allocation in accordance with the attached S-Link unit position, making the S-Link unit as easy to use as a common expansion I/O device.
- If the main wire is broken and an input/output device cannot be recognized, then the S-Link unit displays the device number. This function significantly reduces the time required for troubleshooting during an equipment startup check or recovering from on-site problems.



Specifications

Transmission method	Bi-directional time-divided multiple signal transmission
Synchronization	Bit synchronization, frame synchronization
Transmission protocol	S-Link protocol
Transmission line	Exclusive flat cable or cabtyre cable
Transmission speed	28.5kbps
Transmission distance *1	Main signal wires: Extensible up to 200m (400m when a booster is used)
Connection method	T-branch multi-drop wiring or multi-drop wiring
Number of I/O points	128 points max. (adjustable in encrements of 32 I/O points)

*1 For boosters, see the S-Link catalog and manual issued by SUNX Limited.

FPΣ (Sigma)

Supports the enhancement of your equipment's performance

Network enhancement

■ Modbus-compatible

FPΣ (Sigma) is compatible with the world's de facto standard Modbus* and can serve as both Modbus RTU master and slave, making it ideal for air conditioning or temperature control etc.

* Protocol developed by Modicon Inc., an American company

■ Other available applications

When 17 or more FPΣ (Sigma) units need to be linked, you can use the Modbus function instead of MEWNET-W0 to link up to 99 units. Since each FPΣ (Sigma) unit can be either a master or a slave, a multi-master link can be created by passing a token from a user program.

FPΣ (Sigma) can serve as Modbus master or slave

Can be used as a master station [F145 (Write) and F146 (Read) instructions].
Can easily communicate with temperature controllers, inverters, FP-e and overseas PLCs.

Also serves as a slave station.

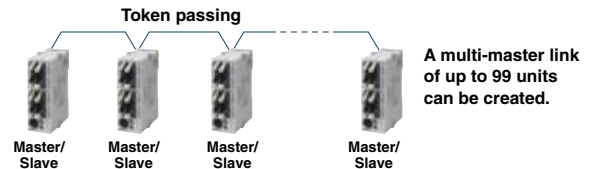
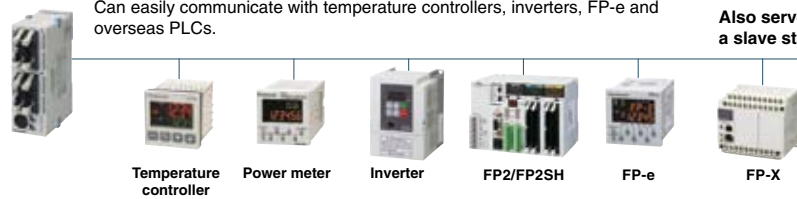

■ New "MEWTOCOL Master" function available

The MEWTOCOL master function automatically creates and transmits commands using the Panasonic open protocol MEWTOCOL. This function significantly facilitates serial communications with MEWTOCOL-compatible equipment, such as PD60/65, KT4H and KW4M.

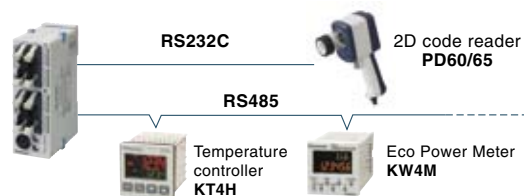

Security enhancement

Programs are copy-protected by the upload restriction setting and an eight-character password.

- The setting to inhibit the uploading of PLC programs to PCs protects your programs from unauthorized copying. (If this setting is released, programs in the PLC are forcibly cleared.)
- An eight-character password has been adopted. (The conventional four-character password is also available.)
Approx. 218 trillion passwords can be set by combining eight alphanumeric characters, making it nearly impossible to crack the password set.

Debugging performance enhancement

Up to 512 steps can be rewritten simultaneously in RUN mode.
This improvement allows efficient program debugging without stopping the operation.

FP Web-Server

FPΣ (Sigma) programming and operation with LAN/WAN

Wordwide communications

The FP Web-Server module connects all FP-series controllers to the Ethernet. No changes to the PLC program are necessary. Simply assign an IP address to the FP Web-Server and connect the PLC to the FP Web-Server via the serial RS232C interface. A standard browser, e.g. MS Internet Explorer, can be used for access at the PC. Configuration of the unit is easily done with the FP Web Configurator Tool, which has to be ordered once separately.

FP Web-Server main features:

- Web-Server:
 - PLC data presented as HTML pages
 - Access via standard internet browser
 - HTML entry field for PLC data change
 - Optional password protection
 - Java applet functions library
 - Ajax JavaScript examples available
- Email:
 - PLC can send emails, also with PLC data attachments
 - Email server access via LAN or Internet dial-up
 - PLC defined or pre-stored mail text
- RS232C device server:
 - Ethernet ↔ RS232C conversion (MEWTOCOL)
 - Transparent RS232C data tunnelling via Ethernet
 - Programming and visualisation access via Ethernet
- Modem / Ethernet gateway:
 - FP Web-Server can be dialled up via modem for local or network access
 - One remote gateway for multiple FP Web-Servers in a local Ethernet network
 - Remote password handling
- Modbus-TCP communication
 - Modbus-TCP server or client for a PLC
 - Modbus-TCP server for multiple PLCs
 - Modbus-TCP server gateway for Modbus-RTU slave unit(s)
 - Modbus-TCP client gateway for any Modbus-RTU master
 - Modbus-TCP master or slave interface for a PLC
- Other functions:
 - XML file delivery for PLC data exchange
 - Network time server functions

- FP Web-Server advantages:
 - Uses existing intranet, saves wiring
 - Uses standard browser, saves Scada software
 - Remote control
 - Remote monitoring
 - Remote programming
 - Alarm information via email
 - Interface/protocol converter



FPWEB2

- IEC60870 communicator

Based on the same hardware as the FP Web-Server safe and easy telecontrol with FP-series PLCs using the wide spread IEC60870-5 telecontrol standard is possible. Thus remote process stations can easily be linked to supervisory control systems or telecontrol main stations. The IEC60870 communicator supports both IEC60870-5-101 communication via RS232C or modem and IEC60870-5-104 communication via Ethernet in one module.

Part number	
FP Web-Server	FPWEB2
Licence to upgrade an FP Web-Server to an IEC60870 communicator	IEC60870LIS
FP Web Configurator Tool	FPWEBTOOL2

Specifications	
Protocols	TCP/IP, UDP/IP, SMTP, PPP, NTP, FTP, TELNET, HTTP, MEWTOCOL-COM
Number of browsers	Up to 64 browsers can be connected to one FP Web-Server
Number of emails	4 predefined in FP Web Flash memory 1 programmable in PLC DT memory as ASCII
Number of email addresses	4 predefined in FP Web flash memory, 1000 addresses in PLC DT memory, assuming an average of 32 characters are used per email address and that an FP0-T32CP with 16k word memory is used
Number of PLC per unit	Two PLCs can be connected 3-pin port (port number: 9094) DB8 port (port number: 9095)
IP address	DHCP or manually set by software
Security	Password and DIP switch
Operating power	24VDC, 75mA (max.)
Dimensions	25 x 90 x 60mm (W x H x D)
LEDs	Power, COM Ethernet connection, COM data exchange
Flash memory	512Kbytes
Standards fulfilled	CE, UL, cUL

Control FFWIN Pro

PLC programming software conforming to IEC 61131-3

FPWIN Pro is the Panasonic programming software developed according to the international standard IEC 61131-3 (for Windows 98, NT V4.0, 2000, ME or XP). This new version is a result of experience gained over many years. We were one of the first PLC manufacturers to offer an IEC 61131-3 programming software, and we are a leading member of the international organisation PLCopen.

Input and output variables are defined once in the global variable list.

Multiple address assignment is caught automatically by the compiler.

Local variables are allocated automatically by the compiler.

Type safe programming using simple or complex data types.

Comfortable programming in the graphical LD editor (ladder diagram).

One instruction for different data types (overloaded instructions).

Temporary variables are allocated and released automatically by the compiler.

Long variable names make the program self-explanatory.

Functions can be saved in libraries for future reuse.

Navigator with tree representation of called functions provides an overview even for very complex projects.

The SFC editor (Sequential Function Chart) allows you to easily visualize processes.

Additional window for monitoring and forcing variables.

Special functions for controlling the SFC program from another program.

Using aliases names for PLC-independent access on the special data registers, e.g. RTC.

The ST editor (Structured Text) solves complex programming tasks.

Using STRING functions for analyzing incoming data...

...or for generating formatted output strings.

Easy handling of formulas and arithmetic expressions.

Structuring with selection statements.

Using loops for running through incoming data...

...or arrays.

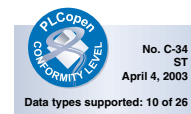
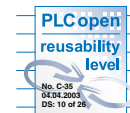

Free demonstration disc

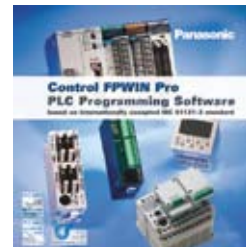

The most important highlights at a glance:

- One software for all FP-series PLCs.
- 5 programming languages (instruction list, ladder diagram, function block diagram, sequential function chart, structured text) available for all PLCs.
- Program organisation units, task and project management provide clear structure.
- Reuse of ready-made functions and function blocks saves time for programming and debugging.
- Online monitoring and diagnostics.
- Forcing – turning off input and output contacts via the PC.
- Modem communication for remote programming, service and diagnostics.
- Extensive comments – online documentation created hand in hand with the program.
- 6 languages are supported: English, German, French, Italian, Spanish and Japanese.

Part numbers:
 FPWINPROF: Full version supports all FP-series PLCs
 FPWINPROS: Small version, supports FP-e, FP0, FP-X and FPΣ (Sigma)

FPΣ (Sigma)

Specification tables

Performance specifications			
Item	Description		
Type of control unit	NPN transistor output type	PNP transistor output type	Relay output type
Part number	FPG-C32T2H-A FPG-C32T2HTM	FPG-C28P2H-A FPG-C28P2HTM	FPG-C24R2H-A FPG-C24R2HTM
Number of I/O points			
	No expansion	32 (Input: 16 / Output: 16)	28 (Input: 16 / Output:12)
	With expansion	Max. 384	Max. 380
Program memory	Built-in Flash ROM (without backup battery)		
Program capacity	32,000 steps		
Operation speed	0.32 μs/step, basic instructions		
Memory for execution			
	External input (X)	1184 points	
	External output (Y)	1184 points	
	Internal relay (R)	4096 points (R0 to R255F)	
	Timer/Counter (T/C)	1024 points 1, 2 / at reset: timer 1008 points (T0-T1007), counter 16 points (C1008-C1023), Timer range is selected by instructions from 1ms, 10ms, 100ms, 1s Counter: 1 to 32,767 counts	
	Link relay (L)	2048 points ¹	
	Data register (DT)	32,765 words (DT0-DT32,764) ¹	
	Link data register (LD)	256 words ¹	
	Index register (I)	14 words (I0-ID)	
Differential points	Unlimited number of points		
Master control relay points	256 points		
Labels (JP+LOOP)	256 labels		
Number of step ladder	1000 stages		
Number of subroutine	100 subroutines		
High-speed counter	Single-phase: 1ch: 50kHz/2ch: 30kHz/3 or 4ch: 20kHz / Two-phase: 1ch: 20kHz/2ch: 15kHz		
Pulse output	1 channel: 100kHz / 2 channel: 60kHz		
PWM output	2 channels, 1.5 to 12.5kHz (at resolution of 1000) / 15.6 to 41.7kHz (at resolution of 100)		
Pulse catch input	8 points (X0-X7)		
Interrupt program	9 programs (external 8 points, 1 periodical interrupt point 0.5ms–30s)		
Self-diagnosis functions	Watchdog timer, program syntax checking, etc.		
Clock/calendar function	Year, month, day, hour, minute, second, and day of week ⁶		
Volume input	2 points resolving power 10bits (K0-K1000)		
Thermistor input	2 points, resolution: 10 bits (0 to 1000) (for C32T2HTM, C24R2HTM and C28P2HTM only)		
Link functions	Computer link (1:1, 1:N) ^{3, 4} General communication (1:1, 1:N) ^{3, 4} PLC link ⁵		
Battery life (battery is optional)	220 days or more* (actual usage value: approx. 840 days (25°C) Suggested replacement interval: 1 year		
Comment storage	All kinds of comments, including I/O comments, remarks and block comments, can be stored (without backup battery)		
Linear/circular interpolation for positioning	Available	Available	Not available
Other functions	Program edition during run, constant scan, forced I/O, password, floating point real number operation, PID processing instruction, comment memory 328kByte		

Notes: 1) If a battery is not used, only fixed area is backed up (Counter: C1008-C1023, internal relay: R900-R97F, Data register: DT32710-DT32764). If a battery is used, backup is possible: Area-setting of hold or no-hold is possible by system register.
 2) Points can be increased using auxiliary timer.
 3) Optional communication cassette (RS232C type) is necessary for 1:1 communication.
 4) Optional communication cassette (RS485 type) is necessary for 1:N communication.
 5) Optional communication cassette (RS485 type) is necessary.
 6) Optional battery is necessary in order to use Clock/Calendar function. Precision calendar timer: at 25°C = 77°F less than 51-second error per month / at 0°C = 32°F less than 119-second error per month / at 55°C = 131°F less than 148-second error per month.

*Value applies when no power is supplied at all.

FPΣ (Sigma)

Specification tables

Input specifications	
Insulation method	Optical coupler
Rated input voltage	24VDC
Input voltage range	21.6 to 26.4VDC
Rated input current	3.5mA–8mA depends on input no.
Input points per common	8 points/common (FPG-C24), 16 points/common (FPG-C32/C28), 32 points/common (FPG-XY64) Either the positive or negative of input power supply can be connected to terminal
Min. ON voltage / Max. OFF current	19.2V / 3mA–6mA depending on input no.
Max. ON voltage / Min. OFF current	2.4V / 1.3mA
Input impedance	3k–6.8k depends on input no.
Response time	CPU: Expansion: 1ms or less, 5μs (HSC, pulse catch, interrupt input) 0.2ms (OFF → ON) 0.3ms (ON → OFF)
Operating indicator	LED

Output specifications – Transistor output type		
Item	FPG-C32 (NPN)	FPG-C28 (PNP)
Insulation method	Optical coupler	
Output method	Open collector	
Rated voltage range	5 to 24VDC	24VDC
Operating load voltage range	4.75 to 26.4VDC	21.6 to 26.4VDC
Max. load current	For Y0, Y1, Y3, Y4: 0.3A – For Y2, Y5 to YF: 0.1A	For Y0, Y1, Y3, Y4: 0.5A – For Y2, Y5 to YB: 0.3A
Max. surge current	For Y0, Y1, Y3, Y4: 0.9A – For Y2, Y5 to YF: 0.5A	For Y0, Y1, Y3, Y4: 1.5A – For Y2, Y5 to YB: 0.7A
Output points per common	16 points/common	12 points/common
Response time	OFF → ON	For Y0, Y1, Y3, Y4 at 15mA or less: <2μs – For Y2, Y5 and higher: < 0.2ms
	ON → OFF	For Y0, Y1, Y3, Y4 at 15mA or less: <8μs – For Y2, Y5 and higher: < 0.5ms
Power supply for driving internal circuit	21.6 to 26.4VDC (70mA)	
Operating indicator	LED	
Phase fault protection	Thermal protection for Y2, Y5 and higher	

Output specifications – relay output type		
Output type	Normally open (1 Form A)	
Rated control capacity	2A 250VAC, 2A 30VDC (max. 4.5A/common) (resistive load)	
Output points per common	8 points/common	
Response time	OFF → ON	10ms or less
	ON → OFF	8ms or less
Mechanical life time	20 million operations or more	
Electrical life time	100,000 operations or more	
Surge absorber	None	
Operating indicator	LED	

Shock resistance	98m/s ² or more, 4 times on 3 axes
Noise humidity	1000V (p-p) with pulse widths 50ns and 1μs
Operating condition	Free from corrosive gasses and excessive dust

FPΣ (Sigma) product overview

Part numbers

FPΣ (Sigma) control units	
Product name	Part number
FPΣ C28 CPU, 16 inputs, 12 outputs (transistor PNP)	FPG-C28P2H-A
FPΣ C32 CPU, 16 inputs, 16 outputs (transistor NPN)	FPG-C32T2H-A
FPΣ C24 CPU, 16 inputs, 8 outputs (relay)	FPG-C24R2H-A
FPΣ C28 CPU, 16 inputs (+ 2 thermistor inputs) , 12 outputs (transistor PNP)	FPG-C28P2HTM
FPΣ C32 CPU, 16 inputs (+ 2 thermistor inputs) , 16 outputs (transistor NPN)	FPG-C32T2HTM
FPΣ C24 CPU, 16 inputs (+ 2 thermistor inputs), 8 outputs (relay)	FPG-C24R2HTM
FPΣ (Sigma) expansion units (left side expansion)	
FPΣ 64-points I/O expansion unit, 32 inputs, 32 outputs (transistor PNP)	FPG-XY64D2P-A
FPΣ 64-points I/O expansion unit, 32 inputs, 32 outputs (transistor NPN)	FPG-XY64D2T-A
FPΣ memory expansion unit, 256k words	FPG-EM1
FPΣ positioning expansion unit, 1 axis type, transistor output	FPG-PP11
FPΣ positioning expansion unit, 1 axis type, line driver output	FPG-PP12
FPΣ positioning expansion unit, 2 axes type, transistor output	FPG-PP21
FPΣ positioning expansion unit, 2 axes type, line driver output	FPG-PP22
FPΣ positioning expansion unit RTEK, 2 axes type	FPG-PN2AN
FPΣ positioning expansion unit RTEK, 4 axes type	FPG-PN4AN
FPΣ positioning expansion unit RTEK, 8 axes type	FPG-PN8AN
FPΣ PROFIBUS master expansion unit	FPG-DPV1-M
FPΣ FNS + PROFIBUS DP slave module	FPGFNS + AFPNAB6200
FPΣ CANopen master expansion unit	FPG-CAN-M
FPΣ FNS + CANopen slave module	FPGFNS + AFPNAB6218
FPΣ DeviceNet master expansion unit	FPG-DEV-M
FPΣ FNS + DeviceNet slave module	FPGFNS + AFPNAB6201
FPΣ S-Link master expansion unit	FPG-SL
FPΣ CC-Link slave expansion unit	FPG-CCLS
FP0 expansion units (right side expansion)	
FP0-E8RS, 4 inputs, 4 outputs (relay)	FP0-E8RSA
FP0-E8X, 8 inputs	FP0-E8XA
FP0-E8YP, 8 outputs (transistor PNP)	FP0-E8YPA
FP0-E8YT, 8 outputs (transistor NPN)	FP0-E8YTA
FP0-E16RS, 8 inputs, 8 outputs (relay)	FP0-E16RSA
FP0-E16P, 8 inputs, 8 outputs (transistor, PNP)	FP0-E16PA
FP0-E16T, 8 inputs, 8 outputs (transistor, NPN)	FP0-E16TA
FP0-E16X, 16 inputs	FP0-E16XA
FP0-E16YP, 16 outputs (transistor PNP)	FP0-E16YPA
FP0-E16YT, 16 outputs (transistor NPN)	FP0-E16YTA
FP0-E32PA, 16 inputs, 16 outputs (PNP)	FP0-E32PA
FP0-E32RS, 16 inputs, 16 outputs (relay)	FP0-E32RS
FP0-E32T 16 inputs, 16 outputs (NPN)	FP0-E32T
FP0-A21A, 2 analog inputs, 1 analog output	FP0-A21A
FP0A04V, 4 analog outputs, -10 to 10V	FP0-A04V
FP0-A04I, 4 analog outputs, 4 to 20mA	FP0-A04I
FP0-A80A, 8 analog inputs	FP0-A80A
FP0 thermocouple unit, 4 inputs	FP0-TC4
FP0 thermocouple unit, 8 inputs	FP0-TC8
FP0 RTD input unit, 6 inputs	FP0-RTD6
FP Web-Server	FPWEB2

FPΣ (Sigma) product overview

Part numbers

FPΣ (Sigma) accessories	
Product name	Part number
FPΣ 1 channel, RS232C type communication cassette	FPG-COM1
FPΣ 2 channels, RS232C type communication cassette	FPG-COM2
FPΣ 1 channel, RS485 type communication cassette	FPG-COM3
FPΣ 2 channels, RS232C & RS485 type communication cassette	FPG-COM4
FPΣ battery, for memory backup & clock functions	AFPG804
FPΣ power supply cable, 1m	AFPG805
High capacity battery holder	AFPG807
FP memory loader, for transfer of programs without a PC or memory unit (data clear type)	AFP8670
FP memory loader, for transfer of programs without a PC or memory unit (data hold type)	AFP8671

AC power supply	
FP0 AC power supply, 24VDC, 0.7A	FP0-PSA2
FP Power supply, 24VDC, 2.1A	FPPS24050ED

Software		
FPWIN Pro PLC programming software, small version for FP-e, FP0, FPΣ (Sigma) and FP-X		
	with English manual	FPWINPROSEN5
	with German manual	FPWINPROSDE5
	with French manual	FPWINPROSFR5
FPWIN Pro PLC programming software, full version for all FP-series PLCs		
	with English manual	FPWINPROFEN5
	with German manual	FPWINPROFDE5
	with French manual	FPWINPROFFR5
FP OPC server software with one license		AFPS03510D
FP OPC Server license		AFPS03517D
FP Data Analyzer software tool to read and display PLC data		AFPS04510D
Control configurator FM, configuration software for FPΣ (Sigma) FMU		AFPS35510
Configurator PM software tool for FPΣ (Sigma) positioning units RTEK		AFPS66510
PCWAY data monitoring, logging and setting software based on Microsoft Excel		AFW10031
CommX software with USB port dongle		AFW20031
USB port dongle for CommX and PCWAY		AFW1033

North America

Europe

Asia Pacific

China

Japan

Panasonic Electric Works

Please contact our Global Sales Companies in:

Europe		
▶ Headquarters	Panasonic Electric Works Europe AG	Rudolf-Diesel-Ring 2, 83607 Holzkirchen, Tel. +49 (0) 8024 648-0, Fax +49 (0) 8024 648-111, www.panasonic-electric-works.com
▶ Austria	Panasonic Electric Works Austria GmbH	Rep. of PEWDE, Josef Madersperger Str. 2, 2362 Biedermansdorf, Tel. +43 (0) 2236-26846, Fax +43 (0) 2236-46133 www.panasonic-electric-works.at
▶ Benelux	PEW Electronic Materials Europe GmbH Panasonic Electric Works Sales Western Europe B.V.	Ennshafenstraße 30, 4470 Enns, Tel. +43 (0) 7223 883, Fax +43 (0) 7223 88333, www.panasonic-electronic-materials.com De Rijn 4, (Postbus 211), 5684 PJ Best, (5680 AE Best), Netherlands, Tel. +31 (0) 499 372727, Fax +31 (0) 499 372185, www.panasonic-electric-works.nl
▶ Czech Republic	Panasonic Electric Works Czech s.r.o.	Průmyslová 1, 34815 Planá, Tel. (+420)-374 799 990, Fax (+420)-374 799 999, www.panasonic-electric-works.cz
▶ France	Panasonic Electric Works Sales Western Europe B.V.	Succursale française, 10, rue des petits ruisseaux, 91370 Verrières Le Buisson, Tél. +33 (0) 1 6013 5757, Fax +33 (0) 1 6013 5758, www.panasonic-electric-works.fr
▶ Germany	Panasonic Electric Works Deutschland GmbH	Rudolf-Diesel-Ring 2, 83607 Holzkirchen, Tel. +49 (0) 8024 648-0, Fax +49 (0) 8024 648-555, www.panasonic-electric-works.de
▶ Hungary	Panasonic Electric Works Europe AG	Magyarországi Közvetlen Kereskedelmi Képviselő, 1117 Budapest, Neumann János u. 1., Tel. +36 (0) 1482-9258, Fax +36 (0) 1482-9259, www.panasonic-electric-works.hu
▶ Ireland	Panasonic Electric Works UK Ltd.	Dublin, Tel. +353 (0) 14600969, Fax +353 (0) 14601131, www.panasonic-electric-works.co.uk
▶ Italy	Panasonic Electric Works Italia srl	Via del Commercio 3-5 (Z.I. Ferlina), 37012 Bussolengo (VR), Tel. +39 (0) 456752711, Fax +39 (0) 456700444, www.panasonic-electric-works.it
▶ Nordic Countries	Panasonic Electric Works Italia Srl Panasonic Electric Works Nordic AB PEW Fire & Security Technology Europe AB	Building Materials Division, Piazza della Repubblica 24, 20154 Milano MI, Tel. +39-02-2900-5391, Fax +39-02-2900-3466 Sjödängsvägen 10, 19272 Sollentuna, Sweden, Tel. +46 859476680, Fax +46 859476690, www.panasonic-electric-works.se Citadellsvägen 23, 21118 Malmö, Tel. +46 40 697 7000, Fax +46 40 697 7099, www.panasonic-fire-security.com
▶ Poland	Panasonic Electric Works Polska sp. z o.o.	Al. Krakowska 4/6, 02-284 Warszawa, Tel. +48 (0) 22 338-11-33, Fax +48 (0) 22 338-12-00, www.panasonic-electric-works.pl
▶ Portugal	Panasonic Electric Works España S.A.	Portuguese Branch Office, Avda Adelino Amaro da Costa 728 R/C J, 2750-277 Cascais, Tel. +351 214812520, Fax +351 214812529
▶ Spain	Panasonic Electric Works España S.A.	Barajas Park, San Severo 20, 28042 Madrid, Tel. +34 913293875, Fax +34 913292976, www.panasonic-electric-works.es
▶ Switzerland	Panasonic Electric Works Schweiz AG	Grundstrasse 8, 6343 Rotkreuz, Tel. +41 (0) 41 7997050, Fax +41 (0) 41 7997055, www.panasonic-electric-works.ch
▶ United Kingdom	Panasonic Electric Works UK Ltd.	Sunrise Parkway, Linford Wood, Milton Keynes, MK14 6 LF, Tel. +44 (0) 1908 231555, Fax +44 (0) 1908 231599, www.panasonic-electric-works.co.uk
North & South America		
▶ USA	PEW Corporation of America	629 Central Avenue, New Providence, N.J. 07974, Tel. 1-908-464-3550, Fax 1-908-464-8513, www.pewa.panasonic.com
Asia Pacific/China/Japan		
▶ China	Panasonic Electric Works (China) Co., Ltd.	Level 2, Tower W3, The Towers Oriental Plaza, No. 2, East Chang An Ave., Dong Cheng District, Beijing 100738, Tel. (010) 8518-5988, Fax (010) 8518-1297
▶ Hong Kong	Panasonic Electric Works (Hong Kong) Co., Ltd.	RM1205-9, 12/F, Tower 2, The Gateway, 25 Canton Road, Tsimshatsui, Kowloon, Hong Kong, Tel. (0852) 2956-3118, Fax (0852) 2956-0398
▶ Japan	Matsushita Electric Works, Ltd.	1048 Kadoma, Kadoma-shi, Osaka 571-8686, Japan, Tel. (06) 6908-1050, Fax (06) 6908-5781, www.mew.co.jp/e-acg/
▶ Singapore	Panasonic Electric Works Asia Pacific Pte. Ltd.	101 Thomson Road, #25-03/05, United Square, Singapore 307591, Tel. (06255) 5473, Fax (06253) 5689