

## Evaluation Board for the ADP1850DP Step-Down DC-to-DC Controller

### FEATURES

**Input range: 10 V to 15 V**

**Output voltage: 1.09 V**

**Output current: 50 A**

**Switching frequency: 300 kHz**

**Operates in PWM**

**Compact, low cost, and efficient design**

### EVALUATION BOARD DESCRIPTION

This document describes the design, operation, and test results of the ADP1850DP-EVALZ operating in dual-phase mode. The input range for this evaluation board is 10 V to 15 V, and the regulated output voltage is 1.09 V with a maximum 50 A output current. A switching frequency ( $f_{sw}$ ) of 300 kHz is chosen to achieve a good balance between efficiency and the sizes of the power components.

### ADP1850 DEVICE DESCRIPTION

The [ADP1850](#) is a dual-channel, step-down switching controller with integrated drivers for external N-channel synchronous

power MOSFETs. The two PWM outputs are phase shifted 180°, which reduces the input RMS ripple current, thus minimizing required input capacitance. The two outputs can be combined for dual-phase PWM operation that can deliver more than 50 A output current. The internal parameters of the two channels are optimized for current sharing.

In addition, boost diodes are integrated into the ADP1850, thus lowering the overall system cost and component count. The ADP1850 can be set to operate in pulse skip, high efficiency mode under light load or in PWM continuous conduction mode.

The ADP1850 includes externally adjustable soft start, output overvoltage protection, externally adjustable current limit, power good, tracking function, and a programmable oscillator frequency that ranges from 200 kHz to 1.5 MHz. The ADP1850 provides an output voltage accuracy of  $\pm 0.85\%$  from  $-40^{\circ}\text{C}$  to  $+85^{\circ}\text{C}$  and  $\pm 1.5\%$  from  $-40^{\circ}\text{C}$  to  $+125^{\circ}\text{C}$  junction temperature. This controller may be powered from a 2.75 V to 20 V supply is available in a 32-lead 5 mm  $\times$  5 mm LFCSP package.

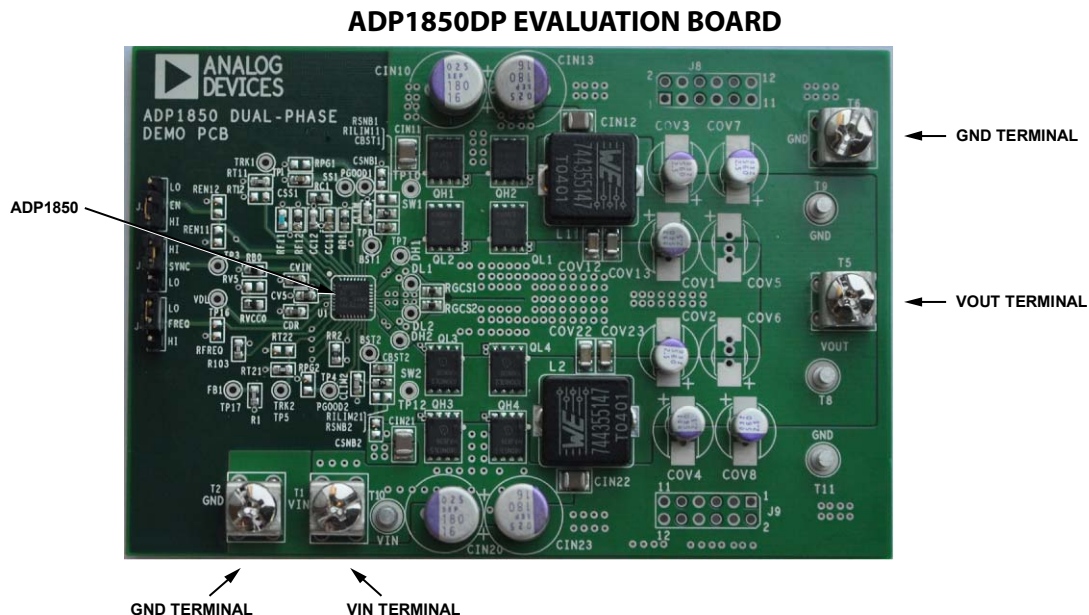

09456-001

**TABLE OF CONTENTS**

Features .....	1	Output Capacitors .....	3
Evaluation Board Description.....	1	MOSFET Selection.....	3
ADP1850 Device Description.....	1	Test Results .....	4
ADP1850DP Evaluation Board.....	1	Evaluation Board Operating Instruction .....	5
Revision History .....	2	Other Information About the Evaluation Board PCB Layout.....	6
Component Design .....	3	Evaluation Board Schematics and Artwork .....	7
Inductor Selection .....	3	Ordering Information.....	11
Input Capacitors .....	3	Bill of Materials.....	11

**REVISION HISTORY**

**8/11—Rev. 0 to Rev. A**

Changes to Table 3.....	11
-------------------------	----

**11/10—Revision 0: Initial Version**

## COMPONENT DESIGN

For information about selecting power components and calculating component values, see the [ADP1850](#) data sheet.

### INDUCTOR SELECTION

A 0.47  $\mu\text{H}$  inductor with a 50 A saturation current rating and a 30 A average current rating (744355147 from Würth Elektronik) is selected. This is a compact inductor with an iron alloy core, which offers high performance in terms of low  $R_{\text{DC}}$  and low core loss. An alternative to the 744355147 is the SER1408-301M (300 nH with about 40 A in saturation current and average current rating) from Coilcraft. If higher efficiency or lower DCR is desired, choose a physically larger inductor with approximately the same inductance value.

### INPUT CAPACITORS

Because of the large input current ripple requirement, four 180  $\mu\text{F}/16\text{ V}$  OS-CON™ capacitors have been selected for the input bulk capacitance. In addition, one MLCC decoupling capacitor (10  $\mu\text{F}/25\text{ V}$ ) is used at each of the high-side MOSFET.

### OUTPUT CAPACITORS

A total of six 560  $\mu\text{F}/2.5\text{ V}$  OS-CON™ capacitors is used at the output. These aluminum solid capacitors with conductive polymer have low ESR and high current ripple rating. In addition, four 47  $\mu\text{F}$  MLCCs are added for filtering out the high frequency voltage ripples.

### MOSFET SELECTION

For low output or low duty cycle, select a high-side MOSFET with fast rise and fall times and with low input capacitance to minimize charging and switching power loss. As for the synchronous rectifier (low-side MOSFET), select a MOSFET with low  $R_{\text{DS(on)}}$  because the switching speed is not critical and there is no switching power loss in the low-side MOSFET.

For the high-side MOSFETs of each channel, two BSC080N03LS connected in parallel from Infineon Technologies in the PG-TDSON-8 or Super-SO8 package are selected. This part has low input capacitance (1.2 nF) and fast transition time (3 ns). For the low-side MOSFET, two BSC030N03LS connected in parallel, with  $R_{\text{DS(on)}}$  of 4.7 m $\Omega$  at a  $V_{\text{GS}}$  of 4.5 V, are selected.

TEST RESULTS

T<sub>A</sub> = 25°C.

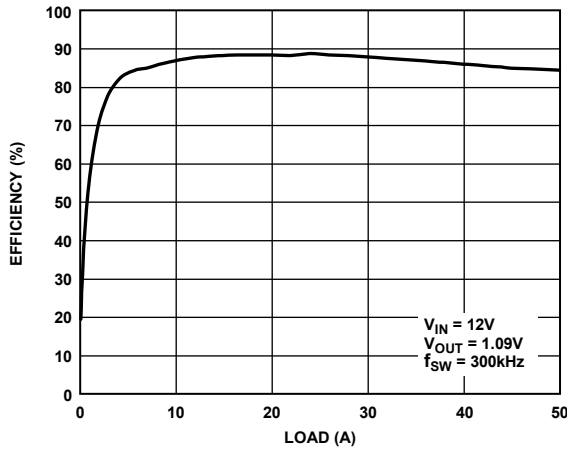

Figure 2. Efficiency

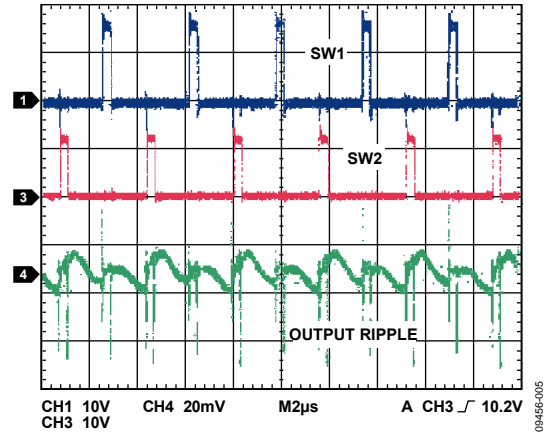

Figure 5. Output Ripple, 50 A Load

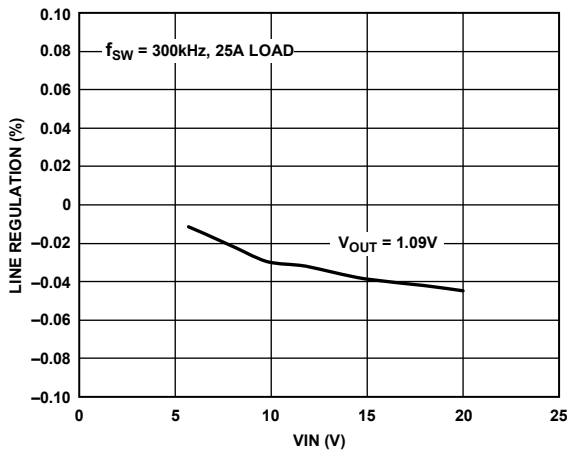

Figure 3. Line Regulation

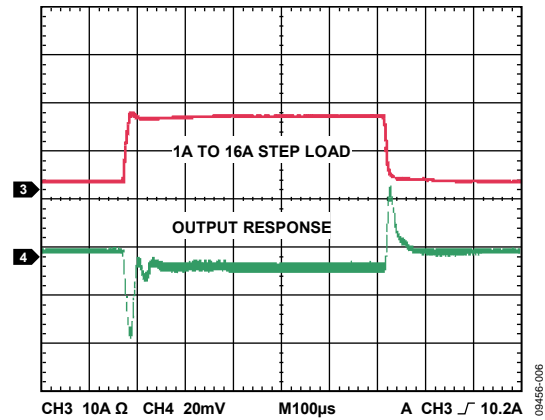

Figure 6. Step Load Transient, V<sub>OUT</sub>

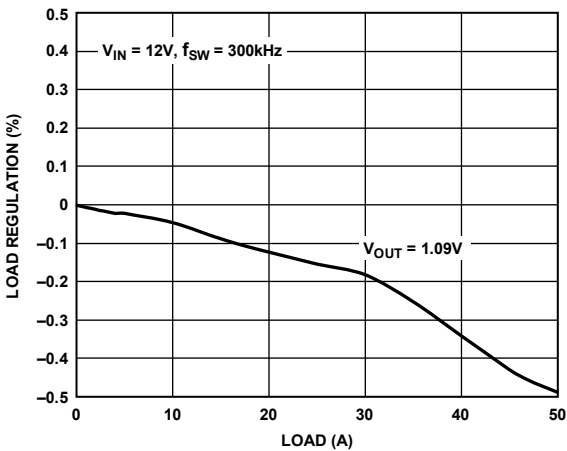

Figure 4. Load Regulation

09456-002

09456-005

09456-003

09456-006

09456-004

## EVALUATION BOARD OPERATING INSTRUCTION

1. Connect Jumper J3 (EN) to the high position to enable Channel 1 and Channel 2 of the ADP1850. Jumper J3 is connected to both EN1 and EN2.
2. Connect Jumper J4 (FREQ) to the low position for 300 kHz operation.
3. Connect Jumper J1 (SYNC) to the high position for PWM operation.
4. Connect the positive terminal of the input power supply to the input terminal, T1. The input range is 10 V to 15 V.

**Table 1. Jumper Description**

Jumper	Description	Default Factory Setting	Function
J1	SYNC	High	Connect high for PWM. For synchronization to an external clock, run the external clock source to this pin.
J3	EN	High	Connect high to enable Channel 1 and Channel 2 of the ADP1850 or low to disable both channels.
J4	FREQ	Low	Connect low for 300 kHz or high for 600 kHz operation. This 50 A evaluation board is configured for operation at 300 kHz. Connect J4 low.

**Table 2. Performance Summary ( $T_A = 25^\circ\text{C}$ )**

Parameter	Condition
$V_{IN}$	10 V to 15 V
$f_{SW}$	Switching frequency, 300 kHz
$V_{OUT}$	1.09 V
$I_{OUT}$	0 A to 50 A
$V_{OUT}$ Ripple, DC Load	16 mV at 50 A load
$V_{OUT}$ Deviation upon Step Load Release	3.3% with a 20 A step load

**OTHER INFORMATION ABOUT THE EVALUATION BOARD PCB LAYOUT**

As seen in Figure 1, the layout of this evaluation board is not optimized for the smallest PCB area. It is laid out in such a way that any of the components can be desoldered and replaced easily with different components with a hand soldering iron so that the user can modify the existing design without acquiring a new PCB layout. The physical size of the compensation components is 0603, which is selected for its ease of hand soldering when reworking the board is needed. The size of these components can be 0402 or even smaller in the final design. Note that there are extra place holders for input bulk capacitors, output filter capacitors, and MOSFETs. The user

can remove, add, or change any of these power components to achieve a particular design objective. The track functions, where TRK1 and TRK2 are pulled up to VCCO through 0  $\Omega$  dummy resistors, are not used on this evaluation board. Also dummy 0  $\Omega$  resistors are placed at the driver gates, DHx and DLx, for evaluation purpose only and can be removed in the final design. Furthermore, many test points are placed on the evaluation board so that the user can easily evaluate the performances of the [ADP1850](#) with an oscilloscope. See Figure 7, the evaluation board schematic, for more information.



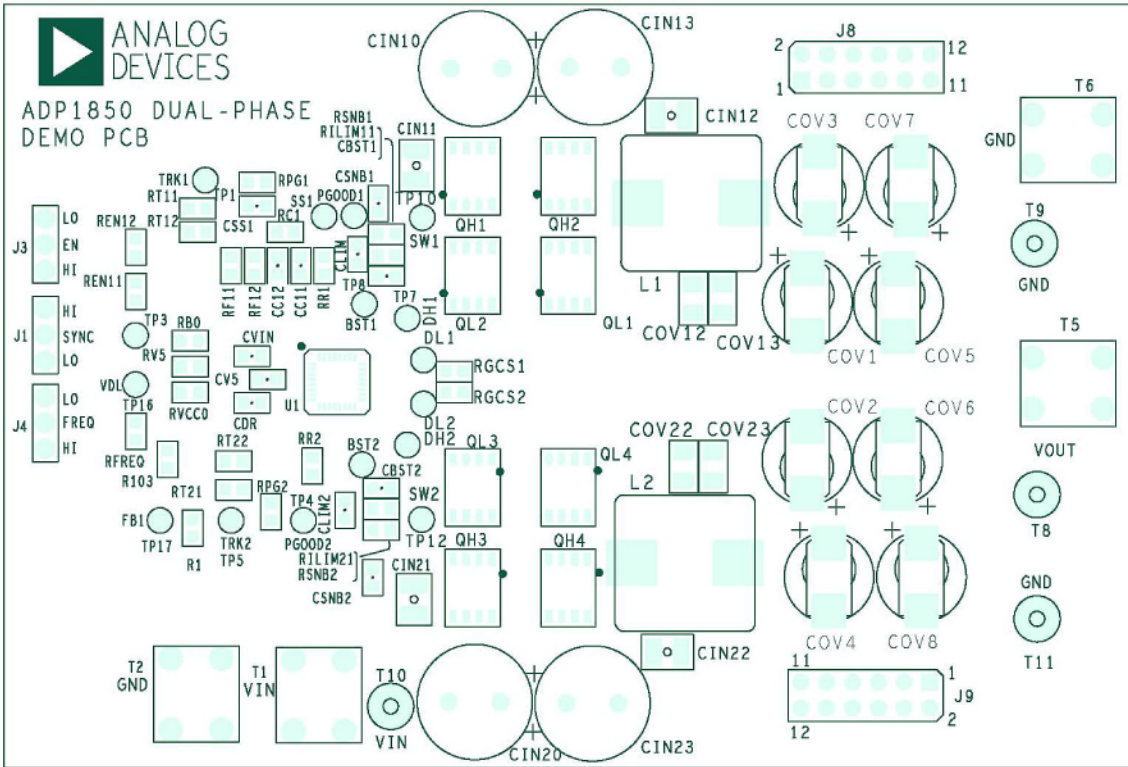

Figure 8. Top Silkscreen

09456-008

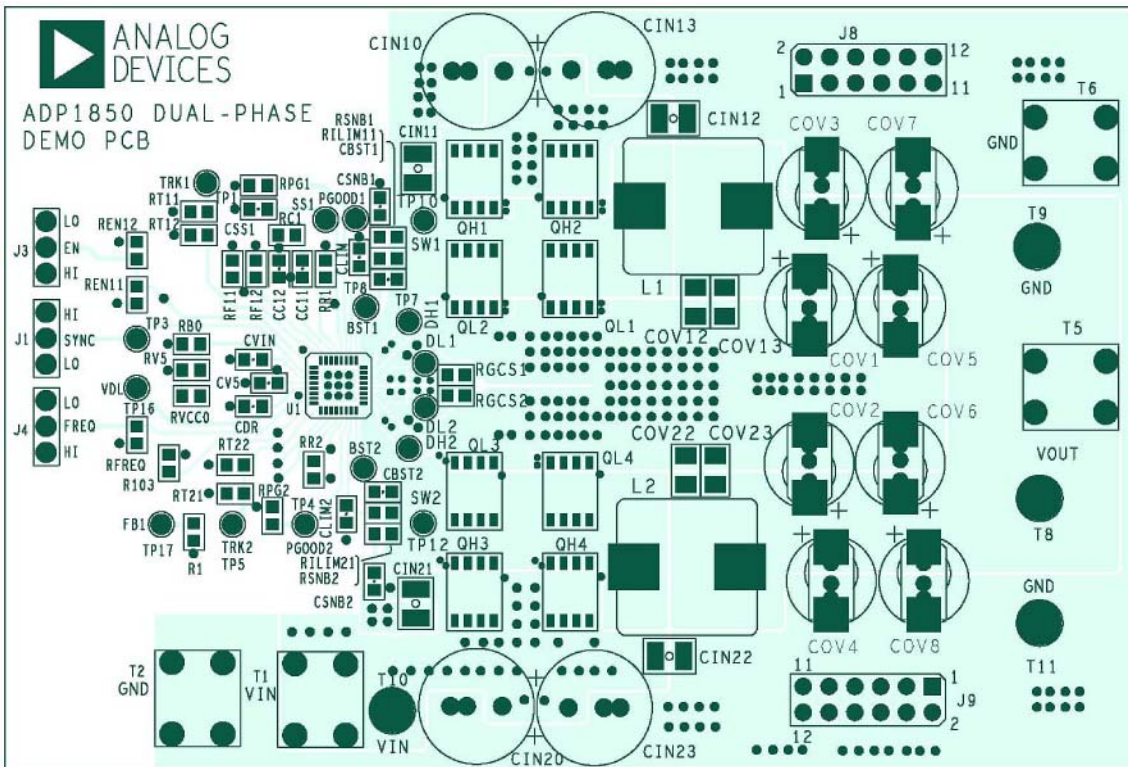
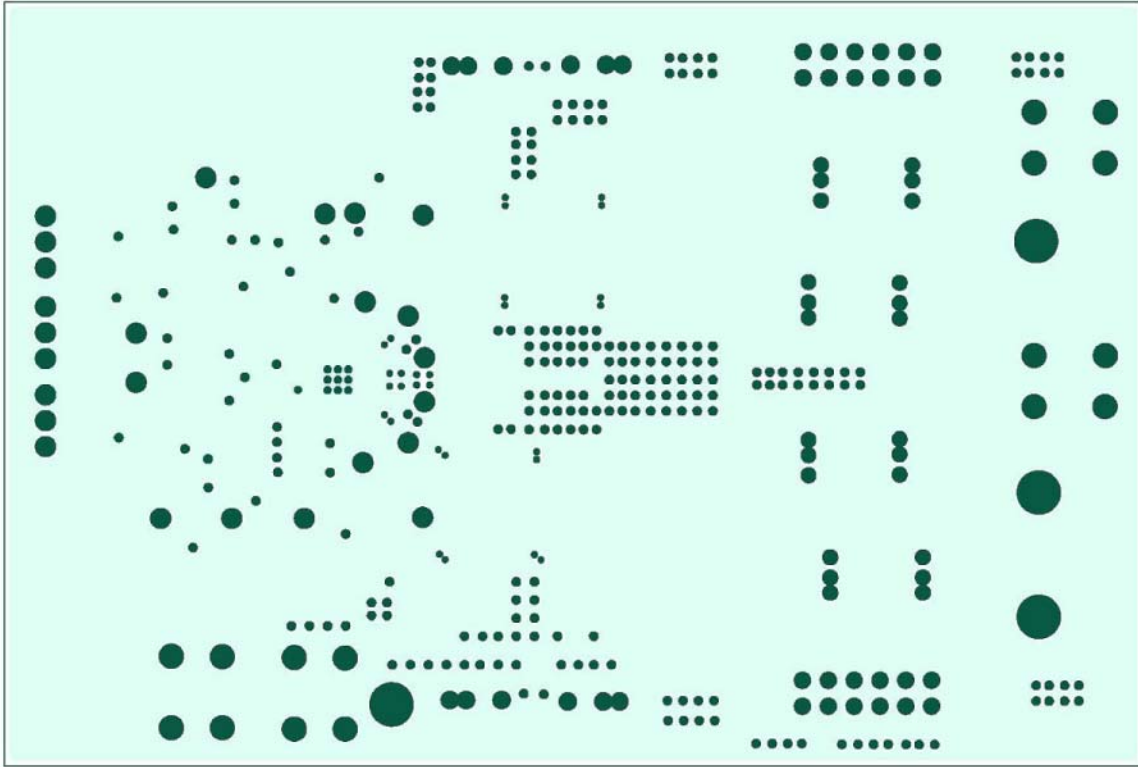

Figure 9. Top Layer

09456-009





09456-010

Figure 10. Second Layer (AGND Plane)

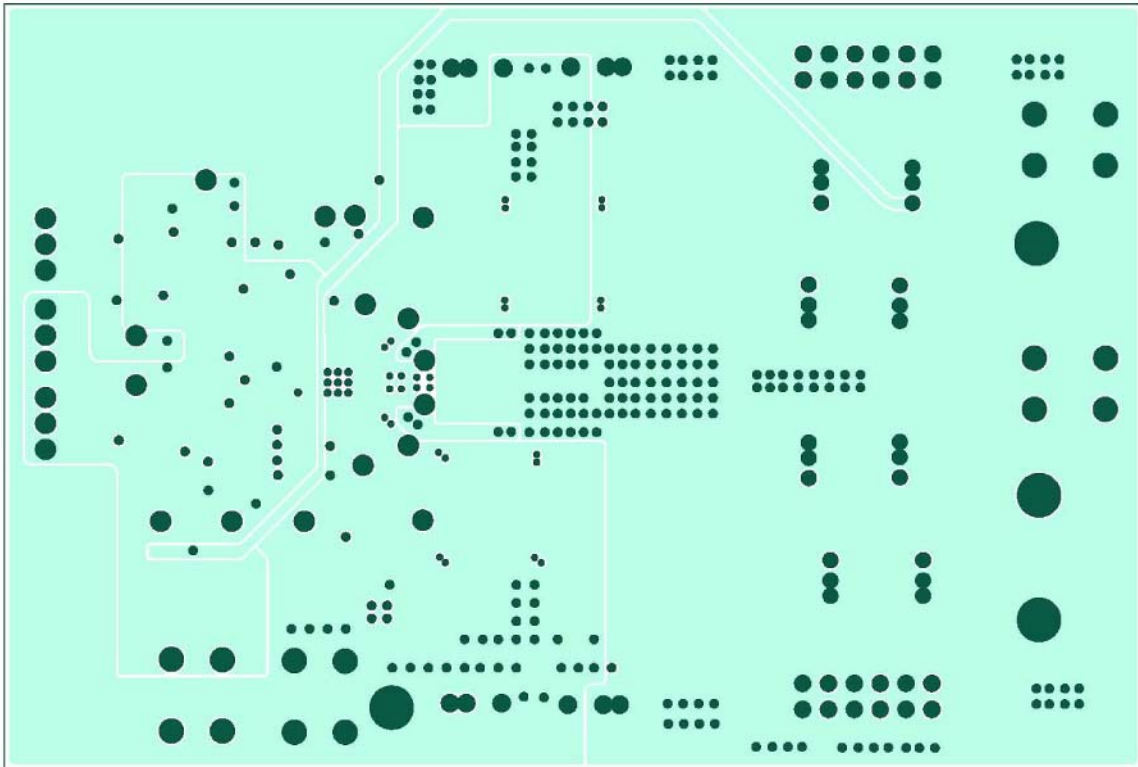

09456-011

Figure 11. Third Layer (PGND Layer)

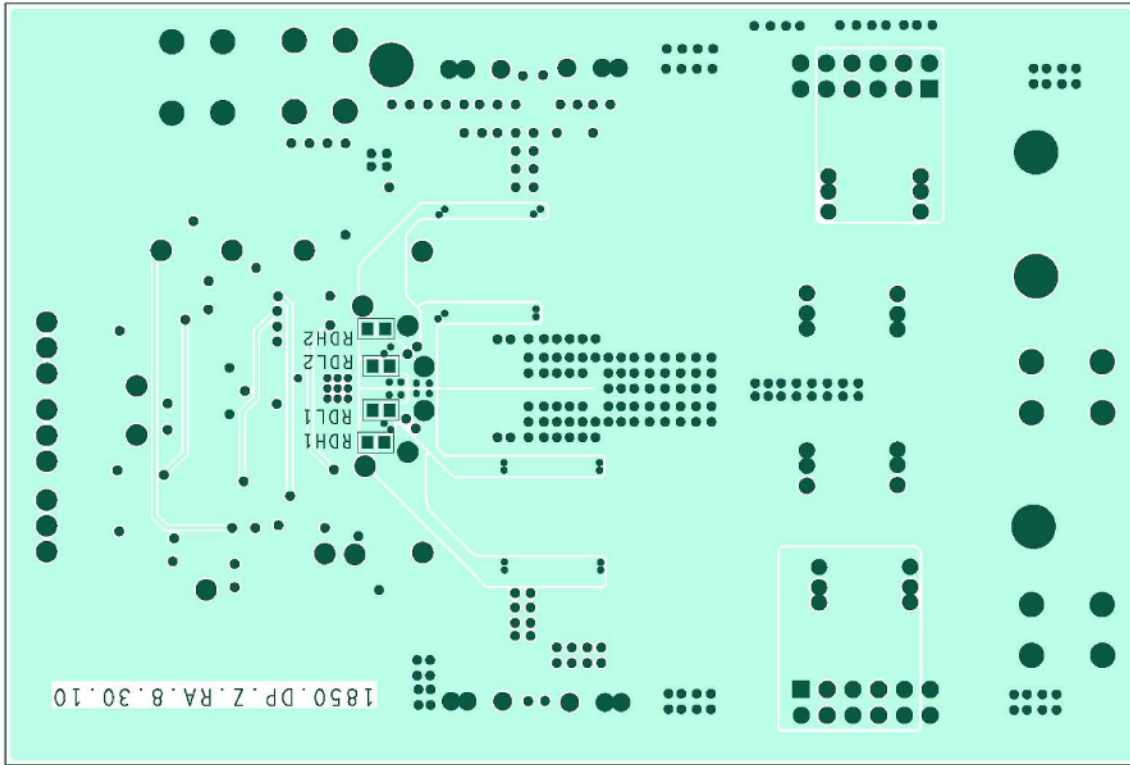

09456-012

Figure 12. Bottom Layer (PGND Layer)

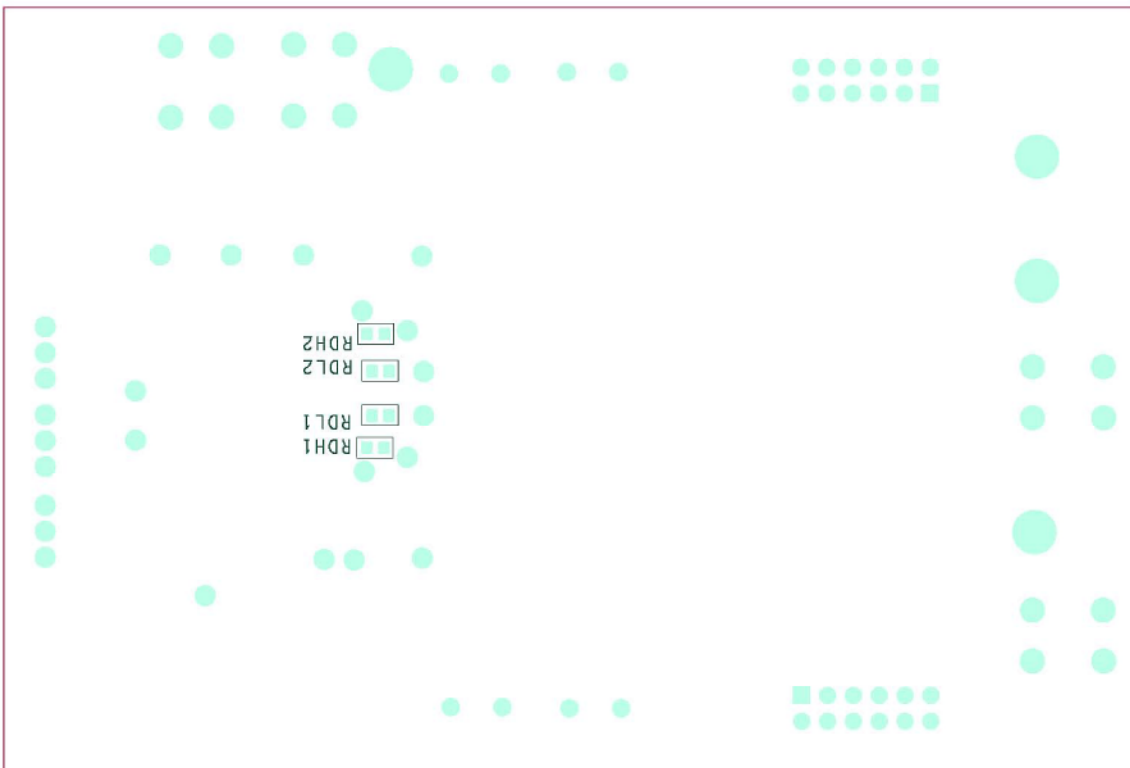

09456-013

Figure 13. Bottom Silk Screen

**ORDERING INFORMATION****BILL OF MATERIALS**

Table 3.

Quantity	Reference Designator	Description	Manufacturer	Part No.
1	U1	DUT	Analog Devices, Inc.	ADP1850
4	CIN10, CIN13, CIN20, CIN23	OSCON, 180 $\mu$ F, 16 V	Sanyo	16SEP180M
4	CIN11, CIN12, CIN21, CIN22	MLCC, 10 $\mu$ F, X7R, 25 V	Murata	GRM32DR71E106KA12
4	CSS1, CBST1, CBST2, CVIN	MLCC, 100 nF, X7R, 25 V	Murata	GRM188R71E104KA01
2	CV5, CDR	MLCC, 1.0 $\mu$ F, X5R, 6.3 V	Murata	GRM185R60J105KE21
2	RB0, RVCCO	Resistor, 2 $\Omega$	Vishay	CRCW06032R00F
2	RGCS1, RGCS2	Resistor, 22.6 k $\Omega$	Vishay	CRCW06032262F
2	RR1, RR2	Resistor, 137 k $\Omega$	Vishay	CRCW06031373F
6	COV1, COV2, COV3, COV4, COV7, COV8	OSCON, 560 $\mu$ F, 2.5V	Sanyo	2SEPC560MZ
4	COV12, COV13, COV22, COV23	MLCC, 47 $\mu$ F, X5R, 1206	Murata	GRM31CR60J476ME19
2	L1, L2	Inductor, 0.47 $\mu$ H	Würth Elektronik	744355147
1	RF12	Resistor, 10 k $\Omega$	Vishay	CRCW06031002F
1	RF11	Resistor, 8.25 k $\Omega$	Vishay	CRCW06038251F
4	QH1, QH2, QH3, QH4	N MOSFET, 30 V, 9 m $\Omega$	Infineon	BSC080N03LS
4	QL1, QL2, QL3, QL4	N MOSFET, 30 V, 4.5 m $\Omega$	Infineon	BSC030N03LS
1	CC11	MLCC, 3300 pF	Vishay	VJ0603Y332KXAA
1	CC12	MLCC, 180 pF	Vishay	VJ0603Y181KXAA
1	RC1	Resistor, 8.87 k $\Omega$	Vishay	CRCW06038871F
2	RLIM11, RLIM21	Resistor, 1.74 k $\Omega$	Vishay	CRCW06031741F
2	CLIM1, CLIM2	MLCC, 22 pF	Vishay	VJ0603A220KXAA
4	J1, J2, J3, J4	3-terminal jumpers, 0.1" spacing		
9	R103, RT11, RT21, RDH1, RDH2, RDL1, RDL2, R1, R2	Resistor, 0 $\Omega$	Vishay	CRCW06030R00F
4	T8, T9, T10, T11	Test points, turret, 110-mil through hole	Keystone Electronics Corp.	1502-1
4	T1, T2, T5, T6	Terminals, 20 A rated	Keystone Electronics Corp.	8191

## NOTES

**ESD Caution**

**ESD (electrostatic discharge) sensitive device.** Charged devices and circuit boards can discharge without detection. Although this product features patented or proprietary protection circuitry, damage may occur on devices subjected to high energy ESD. Therefore, proper ESD precautions should be taken to avoid performance degradation or loss of functionality.

**Legal Terms and Conditions**

By using the evaluation board discussed herein (together with any tools, components documentation or support materials, the "Evaluation Board"), you are agreeing to be bound by the terms and conditions set forth below ("Agreement") unless you have purchased the Evaluation Board, in which case the Analog Devices Standard Terms and Conditions of Sale shall govern. Do not use the Evaluation Board until you have read and agreed to the Agreement. Your use of the Evaluation Board shall signify your acceptance of the Agreement. This Agreement is made by and between you ("Customer") and Analog Devices, Inc. ("ADI"), with its principal place of business at One Technology Way, Norwood, MA 02062, USA. Subject to the terms and conditions of the Agreement, ADI hereby grants to Customer a free, limited, personal, temporary, non-exclusive, non-sublicensable, non-transferable license to use the Evaluation Board FOR EVALUATION PURPOSES ONLY. Customer understands and agrees that the Evaluation Board is provided for the sole and exclusive purpose referenced above, and agrees not to use the Evaluation Board for any other purpose. Furthermore, the license granted is expressly made subject to the following additional limitations: Customer shall not (i) rent, lease, display, sell, transfer, assign, sublicense, or distribute the Evaluation Board; and (ii) permit any Third Party to access the Evaluation Board. As used herein, the term "Third Party" includes any entity other than ADI, Customer, their employees, affiliates and in-house consultants. The Evaluation Board is NOT sold to Customer; all rights not expressly granted herein, including ownership of the Evaluation Board, are reserved by ADI. CONFIDENTIALITY. This Agreement and the Evaluation Board shall all be considered the confidential and proprietary information of ADI. Customer may not disclose or transfer any portion of the Evaluation Board to any other party for any reason. Upon discontinuation of use of the Evaluation Board or termination of this Agreement, Customer agrees to promptly return the Evaluation Board to ADI. ADDITIONAL RESTRICTIONS. Customer may not disassemble, decompile or reverse engineer chips on the Evaluation Board. Customer shall inform ADI of any occurred damages or any modifications or alterations it makes to the Evaluation Board, including but not limited to soldering or any other activity that affects the material content of the Evaluation Board. Modifications to the Evaluation Board must comply with applicable law, including but not limited to the RoHS Directive. TERMINATION. ADI may terminate this Agreement at any time upon giving written notice to Customer. Customer agrees to return to ADI the Evaluation Board at that time. LIMITATION OF LIABILITY. THE EVALUATION BOARD PROVIDED HEREUNDER IS PROVIDED "AS IS" AND ADI MAKES NO WARRANTIES OR REPRESENTATIONS OF ANY KIND WITH RESPECT TO IT. ADI SPECIFICALLY DISCLAIMS ANY REPRESENTATIONS, ENDORSEMENTS, GUARANTEES, OR WARRANTIES, EXPRESS OR IMPLIED, RELATED TO THE EVALUATION BOARD INCLUDING, BUT NOT LIMITED TO, THE IMPLIED WARRANTY OF MERCHANTABILITY, TITLE, FITNESS FOR A PARTICULAR PURPOSE OR NON-INFRINGEMENT OF INTELLECTUAL PROPERTY RIGHTS. IN NO EVENT WILL ADI AND ITS LICENSORS BE LIABLE FOR ANY INCIDENTAL, SPECIAL, INDIRECT, OR CONSEQUENTIAL DAMAGES RESULTING FROM CUSTOMER'S POSSESSION OR USE OF THE EVALUATION BOARD, INCLUDING BUT NOT LIMITED TO LOST PROFITS, DELAY COSTS, LABOR COSTS OR LOSS OF GOODWILL. ADI'S TOTAL LIABILITY FROM ANY AND ALL CAUSES SHALL BE LIMITED TO THE AMOUNT OF ONE HUNDRED US DOLLARS (\$100.00). EXPORT. Customer agrees that it will not directly or indirectly export the Evaluation Board to another country, and that it will comply with all applicable United States federal laws and regulations relating to exports. GOVERNING LAW. This Agreement shall be governed by and construed in accordance with the substantive laws of the Commonwealth of Massachusetts (excluding conflict of law rules). Any legal action regarding this Agreement will be heard in the state or federal courts having jurisdiction in Suffolk County, Massachusetts, and Customer hereby submits to the personal jurisdiction and venue of such courts. The United Nations Convention on Contracts for the International Sale of Goods shall not apply to this Agreement and is expressly disclaimed.