

FEATURES

Nonreflective 50 Ω design

Low insertion loss

1.5 dB typical to 6 GHz

2.5 dB typical to 12 GHz

High isolation

50 dB typical to 6 GHz

45 dB typical to 12 GHz

High input linearity

P0.1dB: 28 dBm typical at $V_{CTRL} = -5 V$

P1dB: 30 dBm typical at $V_{CTRL} = -5 V$

IP3: 48 dBm

High power handling

30 dBm insertion loss path

27 dBm hot switching

Negative control voltage: -7 V to -3 V

ESD rating: 250 V (Class 1A) HBM

No low frequency spurious

24-lead, 4 mm × 4 mm LFCSP

APPLICATIONS

Test instrumentation

Microwave radios and very small aperture terminals (VSATs)

Military radios, radars, and electronic counter measures (ECMs)

Telecommunication infrastructure

GENERAL DESCRIPTION

The HMC232A is a nonreflective, SPDT, RF switch manufactured in the gallium arsenide (GaAs) process.

The HMC232A operates from 100 MHz to 12 GHz with better than 1.5 dB insertion loss and 50 dB of isolation at 6 GHz and better than 2.5 dB insertion loss and 45 dB of isolation at 12 GHz. The HMC232A has a nonreflective design, and the RF ports are internally terminated to 50 Ω.

FUNCTIONAL BLOCK DIAGRAM

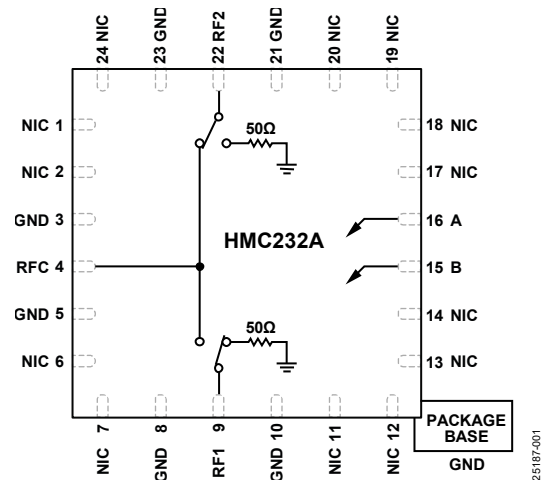

Figure 1.

251897-001

The HMC232A switch operates using complementary negative control voltage logic lines of -7 V to -3 V and requires no bias supply.

The HMC232A comes in a 24-lead, 4 mm × 4 mm LFCSP and operates from -40°C to +85°C.

Rev. B

[Document Feedback](#)

Information furnished by Analog Devices is believed to be accurate and reliable. However, no responsibility is assumed by Analog Devices for its use, nor for any infringements of patents or other rights of third parties that may result from its use. Specifications subject to change without notice. No license is granted by implication or otherwise under any patent or patent rights of Analog Devices. Trademarks and registered trademarks are the property of their respective owners.

TABLE OF CONTENTS

Features	1	Typical Performance Characteristics	6
Applications	1	Insertion Loss, Return Loss, and Isolation	6
Functional Block Diagram	1	Input Compression and Input Third-Order Intercept	7
General Description	1	Theory of Operation	9
Revision History	2	RF Input and Output	9
Specifications	3	Power Supply	9
Electrical Specifications	3	Applications Information	10
Absolute Maximum Ratings	4	Layout Considerations	10
Thermal Resistance	4	Board Layout	10
Power Derating Curve	4	RF and Digital Controls	10
Electrostatic Discharge (ESD) Ratings	4	Outline Dimensions	12
ESD Caution	4	Ordering Guide	12
Pin Configuration and Function Descriptions	5		
Interface Schematics	5		

REVISION HISTORY

10/2022—Rev. 01.0818 to Rev. B

This Hittite Microwave Products data sheet has been reformatted to meet the styles and standards of Analog Devices, Inc.

Changed -5 V to -3 V to -7 V to -3 V	Throughout	Changes to Figure 7, Figure 8, and Figure 10	6
Changes to Features Section, Figure 1, and General Description Section	1	Added Figure 9	6
Changes to Electrical Specifications Section and Table 1	3	Changes to Figure 11	7
Changes to Table 2	4	Added Figure 12 to Figure 16	7
Added Thermal Resistance Section, Table 3; Renumbered Sequentially, Power Derating Curve Section, Figure 2; Renumbered Sequentially, Electrostatic Discharge (ESD) Ratings Section, and Table 4	4	Added Figure 17 to Figure 18	8
Added Figure 3, Interface Schematics Section, and Figure 5	5	Added Theory of Operation Section, RF Input and Output Section, and Power Supply Section	9
Changes to Table 4 and Figure 6	5	Changes to Table 6	9
		Added Applications Information Section, Layout Considerations Section, Board Layout Section, Figure 19, and RF and Digital Controls Section	10
		Added Figure 22	11
		Updated Outline Dimensions	12
		Changes to Ordering Guide	12

SPECIFICATIONS

ELECTRICAL SPECIFICATIONS

Digital control input voltage (V_{CTRL}) = 0 V or -7 V to -3 V, and T_C = 25°C in a 50 Ω system, unless otherwise noted.

Table 1.

Parameter	Symbol	Test Conditions/Comments	Min	Typ	Max	Unit
FREQUENCY RANGE			100		12,000	MHz
INSERTION LOSS						
Between RFC and RF1 or RFC and RF2 (On)		100 MHz to 3 GHz		1.4	1.7	dB
		100 MHz to 6 GHz		1.5	1.8	dB
		100 MHz to 9 GHz		2.0	2.3	dB
		100 MHz to 12 GHz		2.5	3.1	dB
RETURN LOSS						
Between RFC and RF1 or RFC and RF2 (On)		100 MHz to 6 GHz		18		dB
		100 MHz to 9 GHz		14		dB
		100 MHz to 12 GHz		12		dB
RF1 or RF2 (Off)		100 MHz to 12 GHz		14		dB
ISOLATION						
Between RFC and RF1 or RCF and RF2 (Off)		100 MHz to 3 GHz	52	57		dB
		100 MHz to 6 GHz	45	50		dB
		100 MHz to 9 GHz	42	47		dB
		100 MHz to 12 GHz	40	45		dB
SWITCHING CHARACTERISTICS						
Rise Time and Fall Time	t_{RISE}, t_{FALL}	10% to 90% of RF output		6		ns
On Time and Off Time	t_{ON}, t_{OFF}	50% of triggered V_{CTRL} to 90% of RF output		25		ns
INPUT LINEARITY ¹		500 MHz to 12 GHz				
Input Compression						
0.1 dB	P0.1dB	$V_{CTRL} = -3 V$		22		dBm
		$V_{CTRL} = -5 V$		28		dBm
1 dB	P1dB	$V_{CTRL} = -3 V$		26		dBm
		$V_{CTRL} = -5 V$		30		dBm
Intermodulation Distortion						
Input Third-Order Intercept	IIP3	$V_{CTRL} = -3 V$ to $-7 V$, two tone input power = 10 dBm each tone, Δ frequency = 1 MHz		48		dBm
DIGITAL CONTROL INPUTS		A and B pins				
Voltage						
Low	V_{INL}		-0.2		0	V
High	V_{INH}		-7		-3	V
Current						
Low	I_{INL}			0.2		μA
High	I_{INH}			20		μA
RECOMMENDED OPERATING CONDITIONS						
RF Input Power	P_{IN}	$V_{CTRL} = -5 V$, frequency = 500 MHz to 12 GHz, $T_C = 85^\circ C$				
Insertion Loss Path		RF signal is applied to RFC or through connected RF1 or RF2			30	dBm
Terminated Path		RF signal is applied to the terminated RF1 or RF2			23	dBm
Hot Switching		RF signal is present at RFC while switching between RF1 and RF2			27	dBm
T_C			-40		+85	$^\circ C$

¹ For input linearity performance vs. frequency, see Figure 11 through Figure 18.

ABSOLUTE MAXIMUM RATINGS

Table 2.

Parameter	Rating
V _{CTRL}	-7.5 V to +1 V
RF Input Power ¹ (V _{CTRL} = -5 V, frequency = 500 MHz to 12 GHz at T _C = 85°C)	
Insertion Loss Path	30.9 dBm
Terminated Path	23.7 dBm
Hot Switching	27.5 dBm
Temperature	
Junction, T _J	150°C
Storage Range	-65°C to +150°C
Reflow	260°C

¹ For power derating vs. frequency, see Figure 2.

Stresses at or above those listed under Absolute Maximum Ratings may cause permanent damage to the product. This is a stress rating only; functional operation of the product at these or any other conditions above those indicated in the operational section of this specification is not implied. Operation beyond the maximum operating conditions for extended periods may affect product reliability.

THERMAL RESISTANCE

Thermal resistance is directly linked to printed circuit board (PCB) design and operating environment. Careful attention to PCB thermal design is required.

θ_{JC} is the junction to case bottom (channel to package bottom) thermal resistance.

Table 3. Thermal Resistance

Package Type	θ _{JC} ¹	Unit
CP-24-16		
Through Path	88.5	°C/W
Terminated Path	277	°C/W

¹ θ_{JC} was determined by simulation under the following conditions: the heat transfer is due solely to thermal conduction from the channel through the ground pad to the PCB. The ground pad is held constant at an 85°C operating temperature.

POWER DERATING CURVE

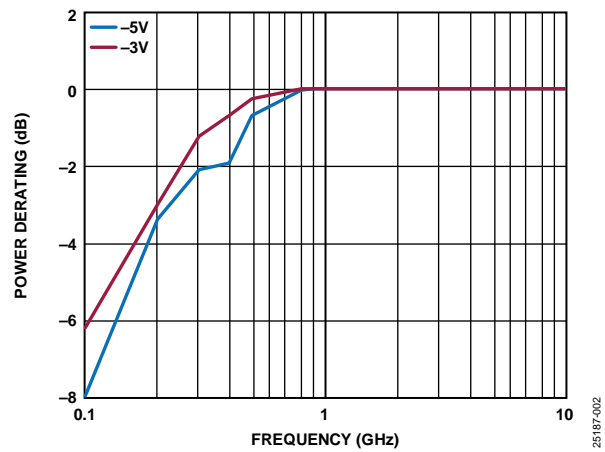

Figure 2. Power Derating vs. Frequency over V_{CTRL}, Low Frequency Detail, T_C = 85°C

ELECTROSTATIC DISCHARGE (ESD) RATINGS

The following ESD information is provided for handling of ESD-sensitive devices in an ESD protected area only.

Human body model (HBM) per ANSI/ESDA/JEDEC JS-001.

ESD Ratings for HMC232A

Table 4. HMC232A, 24-Lead LFCSP

ESD Model	Withstand Threshold (V)	Class
HBM	250	1A

ESD CAUTION



ESD (electrostatic discharge) sensitive device. Charged devices and circuit boards can discharge without detection. Although this product features patented or proprietary protection circuitry, damage may occur on devices subjected to high energy ESD. Therefore, proper ESD precautions should be taken to avoid performance degradation or loss of functionality.

PIN CONFIGURATION AND FUNCTION DESCRIPTIONS

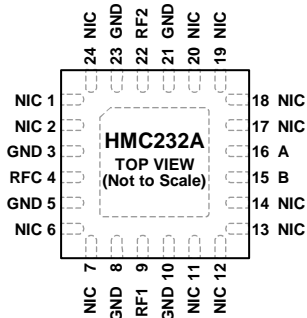

NOTES
 1. NIC = NOT INTERNALLY CONNECTED. HOWEVER, ALL DATA SHOWN HEREIN WAS MEASURED WITH THE NIC PINS CONNECTED TO RF OR DC GROUND EXTERNALLY.
 2. EXPOSED PAD. THE EXPOSED PAD MUST BE CONNECTED TO RF AND DC GROUND OF THE PCB.

25187-003

Figure 3. Pin Configuration (Top View)

Table 5. Pin Function Descriptions

Pin No.	Mnemonic	Description
1, 2, 6, 7, 11 to 14, 17 to 20, 24	NIC	Not Internally Connected. However, all data shown herein was measured with the NIC pins connected to RF or DC ground externally.
3, 5, 8, 10, 21, 23	GND	Ground. The GND pins must be connected to the RF and dc ground of the PCB. See Figure 4 for the interface schematic.
4	RFC	RF Common Port. The RFC pin is dc-coupled and matched to 50 Ω. A dc blocking capacitor is required on the RFC pin. See Figure 5 for the interface schematic.
9	RF1	RF Port 1. The RF1 pin is dc-coupled and matched to 50 Ω. A dc blocking capacitor is required on the RF1 pin. See Figure 5 for the interface schematic.
15	B	Logic Control Input B. See Figure 6 for the control input interface schematic. See Table 6 for the truth table.
16	A	Logic Control Input A. See Figure 6 for the control input interface schematic. See Table 6 for the truth table.
22	RF2	RF Port 2. The RF2 pin is dc-coupled and matched to 50 Ω. A dc blocking capacitor is required on the RF2 pin. See Figure 5 for the interface schematic.
	EPAD	Exposed Pad. The exposed pad must be connected to the RF and dc ground of the PCB.

INTERFACE SCHEMATICS



Figure 4. GND Interface Schematic

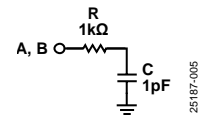

Figure 6. A and B Interface Schematic

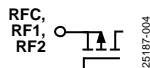

Figure 5. RFC, RF1, and RF2 Interface Schematic

TYPICAL PERFORMANCE CHARACTERISTICS

INSERTION LOSS, RETURN LOSS, AND ISOLATION

$V_{CTRL} = 0\text{ V}$ or -7 V to -3 V , and $T_c = 25^\circ\text{C}$ in a $50\ \Omega$ system, unless otherwise noted.

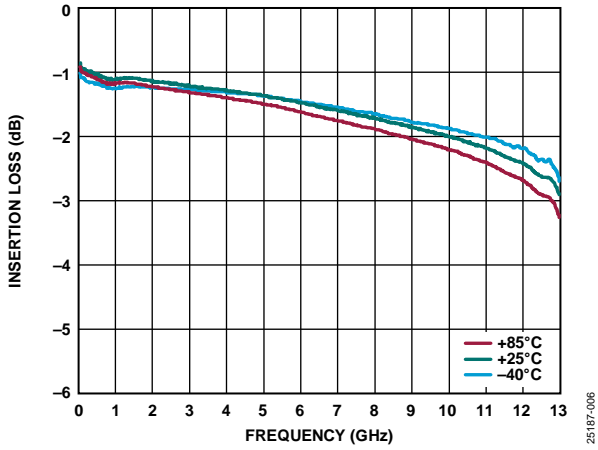

Figure 7. Insertion Loss vs. Frequency over Temperature

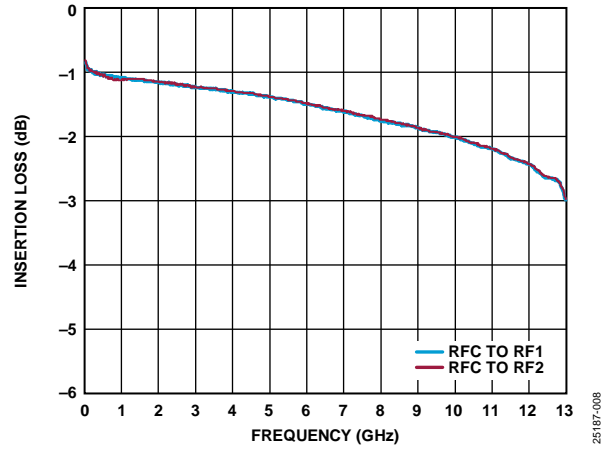

Figure 9. Insertion Loss Between RFC and RFx vs. Frequency

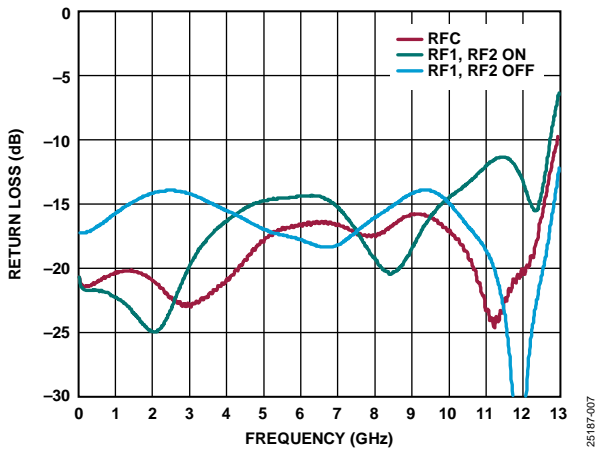

Figure 8. Return Loss vs. Frequency

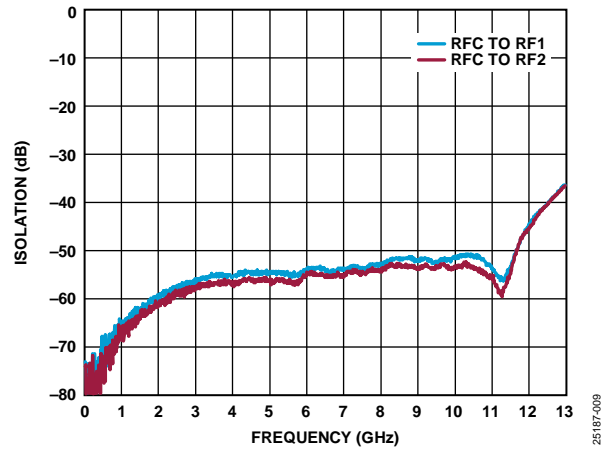

Figure 10. Isolation Between RFC and RFx vs. Frequency

INPUT COMPRESSION AND INPUT THIRD-ORDER INTERCEPT

$V_{CTRL} = 0\text{ V}$ or -7 V to -3 V , and $T_c = 25^\circ\text{C}$ in a $50\ \Omega$ system, unless otherwise noted.

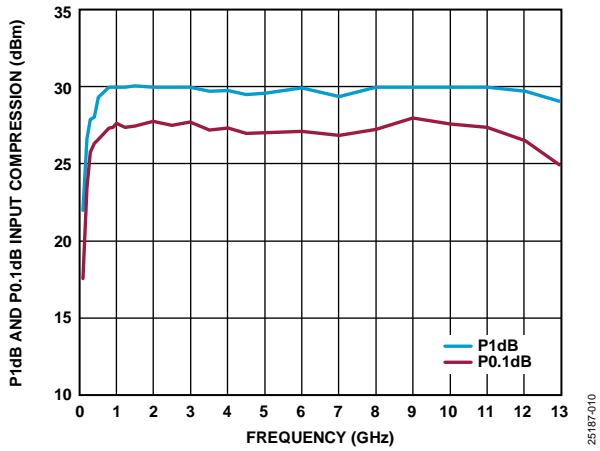

Figure 11. P1dB and P0.1dB Input Compression vs. Frequency, $V_{CTRL} = -5\text{ V}$

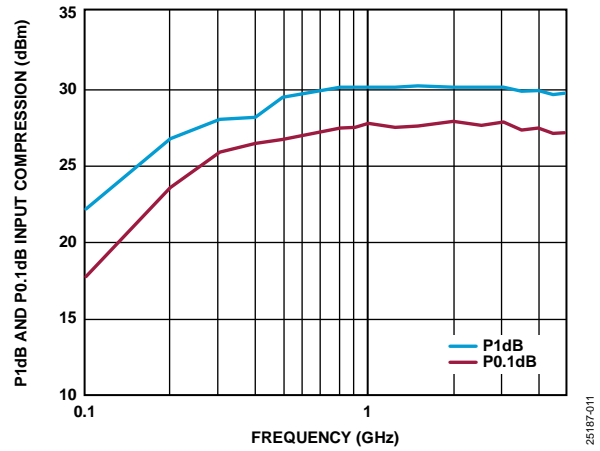

Figure 14. P1dB and P0.1dB Input Compression vs. Frequency (Low Frequency Detail), $V_{CTRL} = -5\text{ V}$

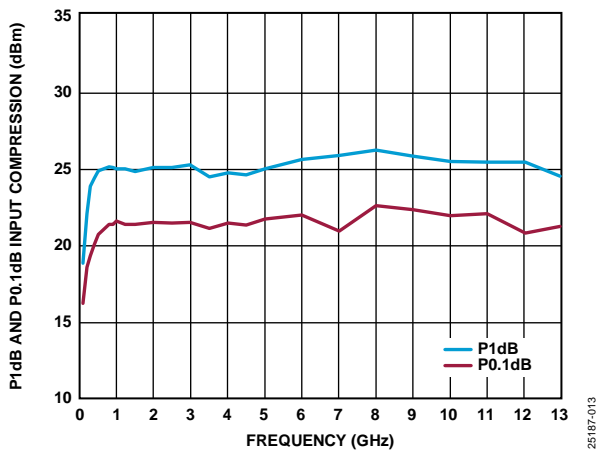

Figure 12. P1dB and P0.1dB Input Compression vs. Frequency, $V_{CTRL} = -3\text{ V}$

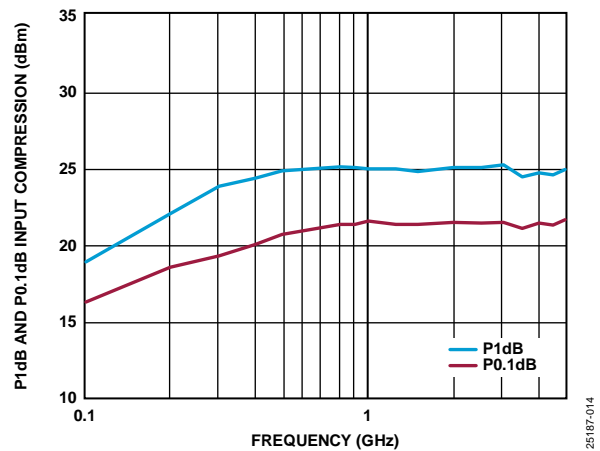

Figure 15. P1dB and P0.1dB Input Compression vs. Frequency (Low Frequency Detail), $V_{CTRL} = -3\text{ V}$

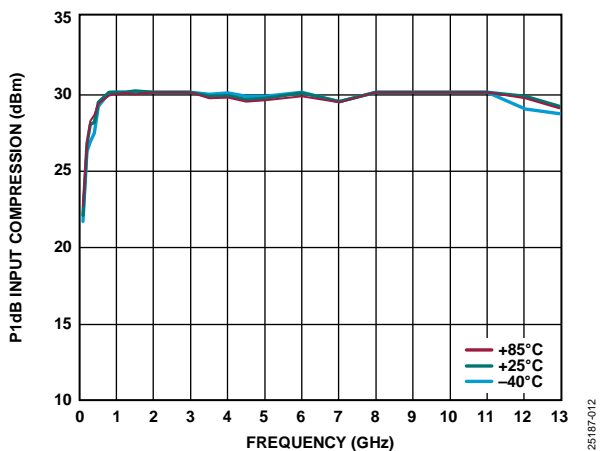

Figure 13. P1dB Input Compression Point vs. Frequency over Temperature, $V_{CTRL} = -5\text{ V}$

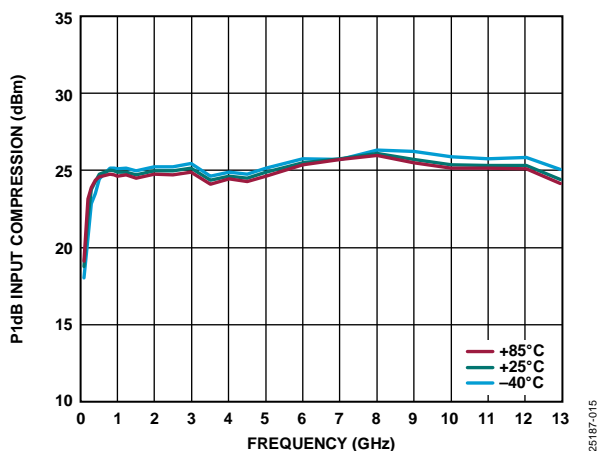

Figure 16. P1dB Input Compression Point vs. Frequency over Temperature, $V_{CTRL} = -3\text{ V}$

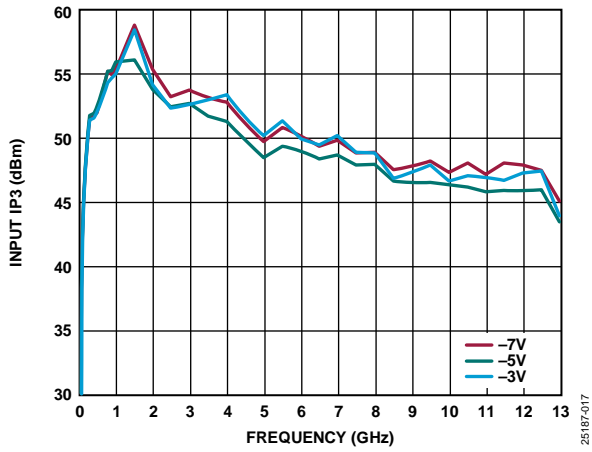

Figure 17. Input IP3 vs. Frequency over V_{CTRL}

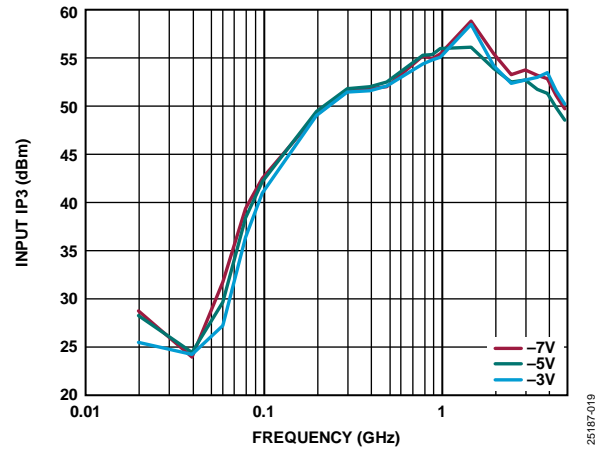

Figure 18. Input IP3 vs. Frequency over V_{CTRL} (Low Frequency Detail)

THEORY OF OPERATION

The HMC232A operates using complementary negative control voltage logic lines and requires no bias supply. The two logic control input pins (A and B) control the state of the RF paths, determining which RFx port is in the insertion loss state and which path is in the isolation state (see Table 6).

RF INPUT AND OUTPUT

All of the RFx ports (RFC, RF1, and RF2) are dc-coupled to 0 V, and no dc blocking capacitors are required at the RFx ports when the RF potential is equal to 0 V.

The RFx ports are internally matched to 50 Ω . Therefore, external matching networks are not required.

The HMC232A is bidirectional, therefore, an RF input signal (RF_{IN}) can be applied to the RFC port or to the RF1 port or the RF2 port.

The insertion loss path conducts the RF signal between the selected RF throw port and the RF common port. The isolation path provides high loss between the insertion loss path and the unselected RF throw port, which is nonreflective, by using an internal 50 Ω termination resistor.

POWER SUPPLY

The HMC232A requires negative voltage applied to the logic control input pins (A and B). Bypassing capacitors are recommended on the supply lines to filter high frequency noise.

The ideal power-up sequence follows:

1. Connect to GND.
2. Power up the digital control inputs. The relative order of the digital control inputs is not important.
3. Apply an RF input signal to RFC, RF1, or RF2.

The ideal power-down sequence is the reverse order of the power-up sequence.

Table 6. Control Voltage Truth Table

Digital Control Inputs		RF Paths	
A	B	RF1 to RFC	RF2 to RFC
High	Low	Insertion loss (on)	Isolation (off)
Low	High	Isolation (off)	Insertion loss (on)
Low	Low	Undefined	Undefined
High	High	Undefined	Undefined

APPLICATIONS INFORMATION

LAYOUT CONSIDERATIONS

All measurements in this data sheet are measured on the EV1HMC232ALP4 evaluation board. The design of this evaluation board can serve as a layout recommendation for applications.

BOARD LAYOUT

The HMC232A is a 4-layer board. The outer copper (Cu) layers are 0.7 mil plated and are separated by dielectric materials. Figure 19 shows the HMC232A board stack up.

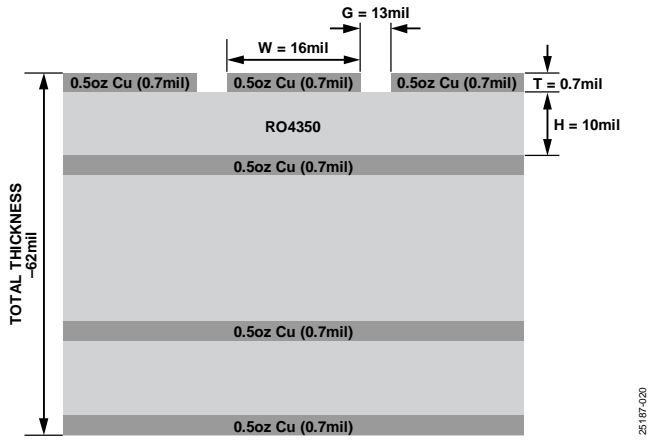

Figure 19. HMC232A Stack Up

All RF and dc traces are routed on the top copper layer, and the inner and bottom layers are ground planes that provide a solid ground for the RF transmission lines. The top dielectric material (H) is 10 mil Rogers RO4350, which allows optimal RF performance. The middle and bottom dielectric layers provide mechanical strength. The overall board thickness is ~62 mil, which allows Subminiature Version A (SMA) connectors to be connected at the board edges.

RF AND DIGITAL CONTROLS

The RF transmission lines are designed using a coplanar waveguide (CPWG) model with a width of 16 mil and a ground spacing (G) of 13 mil and have a characteristic impedance of 50 Ω. For optimal RF and thermal grounding, as many plated through vias as possible are arranged around the transmission lines and under the exposed pad of the package.

Figure 20 shows the top view of the populated EV1HMC232ALP4, which is available from Analog Devices upon request (see the Ordering Guide).

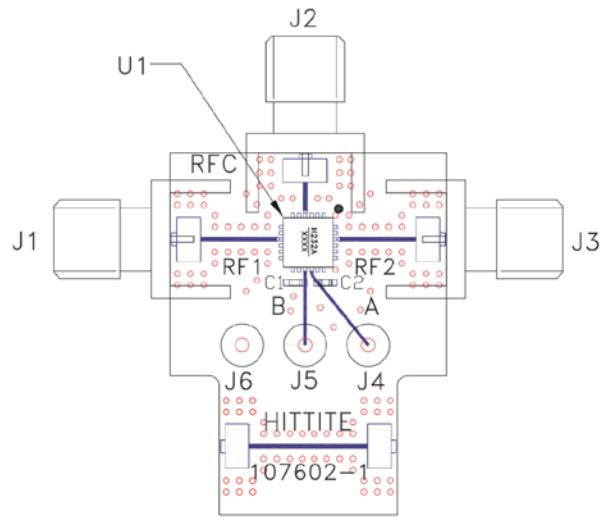

Figure 20. Populated EV1HMC232ALP4—Top View

The RF input and output ports (RFC, RF1, and RF2) are connected through 50 Ω transmission lines to the SMA launchers. On the traces of the logic control input pins (A and B), a 100 pF bypass capacitor was used to filter high frequency noise. Figure 21 shows the suggested driver circuit.

Figure 22 and Table 7 show the typical application circuit and bill of materials for the HMC232A, respectively.

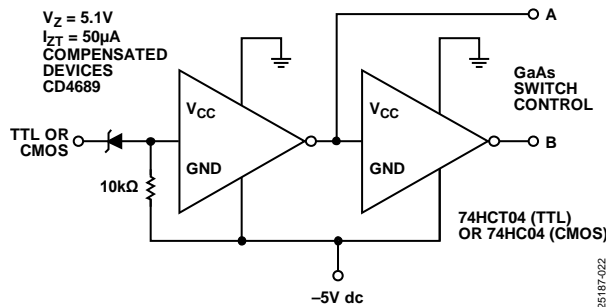

Figure 21. Suggested Driver Circuit (V_Z is the Voltage of the Zener Diode, and I_{ZT} is the Current of the Zener Diode.)

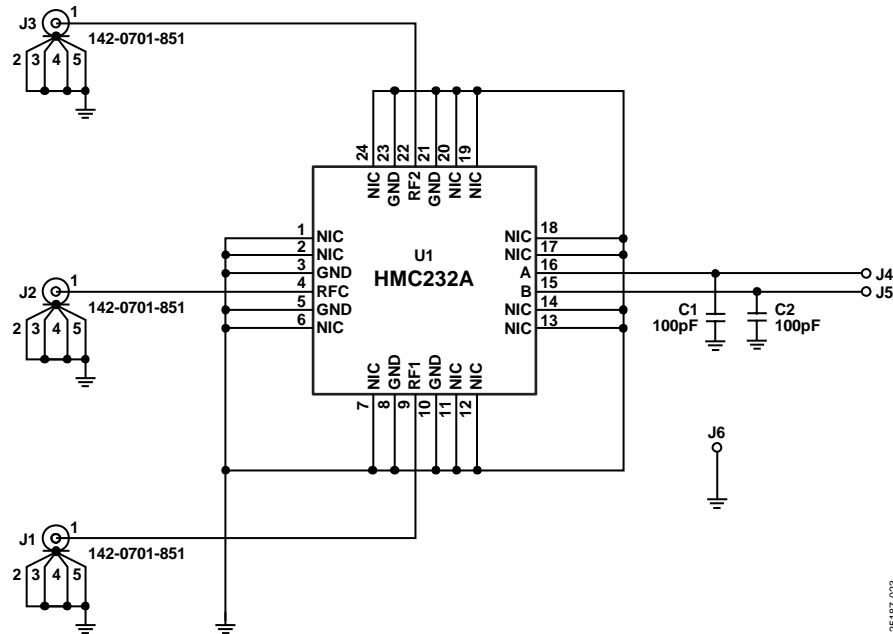

Figure 22. Typical Application Circuit

25187-023

Table 7. Evaluation Board Bill of Materials

Component	Description
J1 to J3	SMA connectors
J4 to J6	DC pins
C1, C2	100 pF capacitors, 0603 package
U1	GaAs, SPDT switch, nonreflective, 100 MHz to 12 GHz, HMC232A
PCB	Evaluation PCB, Analog Devices, 107602, circuit board material Rogers 4350

OUTLINE DIMENSIONS

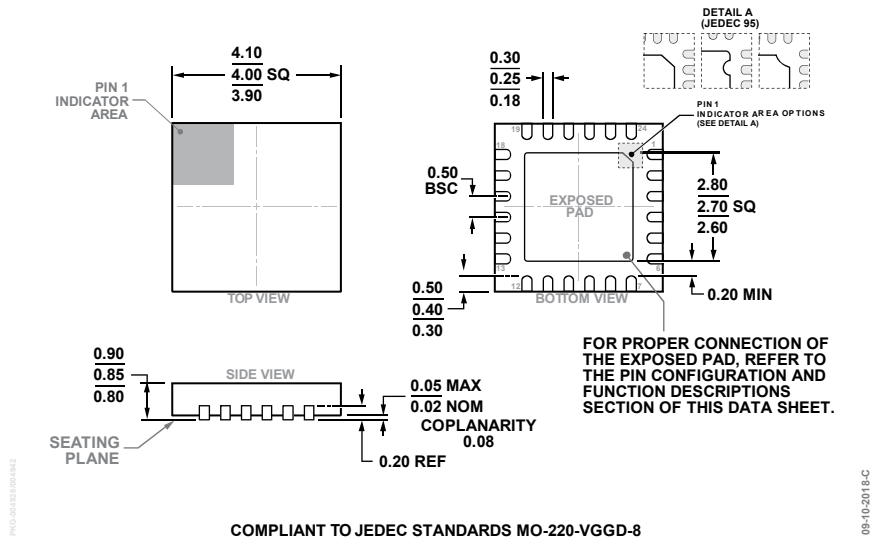

Figure 23. 24-Lead Lead Frame Chip Scale Package [LFCSP]
 4 mm × 4 mm Body and 0.85 mm Package Height
 (CP-24-16)
 Dimensions shown in millimeters

ORDERING GUIDE

Model ¹	Temperature Range	Package Description	Package Option
HMC232ALP4E	-40°C to +85°C	24-Lead Lead Frame Chip Scale Package [LFCSP]	CP-24-16
HMC232ALP4ETR	-40°C to +85°C	24-Lead Lead Frame Chip Scale Package [LFCSP]	CP-24-16
EV1HMC232ALP4		Evaluation Board	

¹ All models are RoHS compliant parts.