

General Description

The AOT2610L & AOTF2610L uses trench MOSFET technology that is uniquely optimized to provide the most efficient high frequency switching performance. Both conduction and switching power losses are minimized due to an extremely low combination of $R_{DS(ON)}$, C_{iss} and C_{oss} . This device is ideal for boost converters and synchronous rectifiers for consumer, telecom, industrial power supplies and LED backlighting.

Product Summary

V_{DS}	60V
I_D (at $V_{GS}=10V$)	55A / 35A
$R_{DS(ON)}$ (at $V_{GS}=10V$)	< 10.7m Ω
$R_{DS(ON)}$ (at $V_{GS}=4.5V$)	< 13.5m Ω

100% UIS Tested
 100% R_g Tested

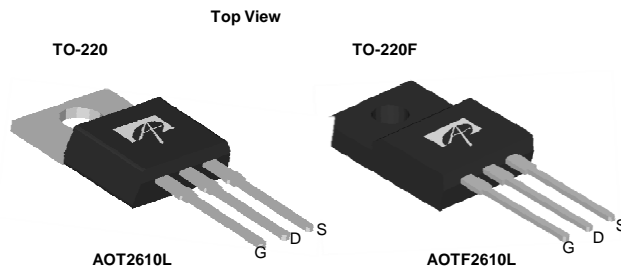
Absolute Maximum Ratings $T_A=25^\circ\text{C}$ unless otherwise noted

Parameter	Symbol	AOT2610L	AOTF2610L	Units	
Drain-Source Voltage	V_{DS}	60		V	
Gate-Source Voltage	V_{GS}	± 20		V	
Continuous Drain Current	I_D	$T_C=25^\circ\text{C}$	55	35	A
		$T_C=100^\circ\text{C}$	39	25	
Pulsed Drain Current ^C	I_{DM}	140			
Continuous Drain Current	I_{DSM}	$T_A=25^\circ\text{C}$	9		A
		$T_A=70^\circ\text{C}$	7		
Avalanche Current ^C	I_{AS}	36		A	
Avalanche energy $L=0.1\text{mH}$ ^C	E_{AS}	65		mJ	
Power Dissipation ^B	P_D	$T_C=25^\circ\text{C}$	75	31	W
		$T_C=100^\circ\text{C}$	37.5	15.5	
Power Dissipation ^A	P_{DSM}	$T_A=25^\circ\text{C}$	2.1		W
		$T_A=70^\circ\text{C}$	1.3		
Junction and Storage Temperature Range	T_J, T_{STG}	-55 to 175		$^\circ\text{C}$	

Thermal Characteristics

Parameter	Symbol	AOT2610L	AOTF2610L	Units
Maximum Junction-to-Ambient ^A	$R_{\theta JA}$	15	15	$^\circ\text{C}/\text{W}$
Maximum Junction-to-Ambient ^{A,D}		60	60	$^\circ\text{C}/\text{W}$
Maximum Junction-to-Case	$R_{\theta JC}$	2.0	4.8	$^\circ\text{C}/\text{W}$

Electrical Characteristics (T_J=25°C unless otherwise noted)

Symbol	Parameter	Conditions	Min	Typ	Max	Units
STATIC PARAMETERS						
BV _{DSS}	Drain-Source Breakdown Voltage	I _D =250μA, V _{GS} =0V	60			V
I _{DSS}	Zero Gate Voltage Drain Current	V _{DS} =60V, V _{GS} =0V T _J =55°C			1 5	μA
I _{GSS}	Gate-Body leakage current	V _{DS} =0V, V _{GS} =±20V			±100	nA
V _{GS(th)}	Gate Threshold Voltage	V _{DS} =V _{GS} , I _D =250μA	1.4	2	2.5	V
I _{D(ON)}	On state drain current	V _{GS} =10V, V _{DS} =5V	140			A
R _{DS(ON)}	Static Drain-Source On-Resistance	V _{GS} =10V, I _D =20A T _J =125°C		8.7	10.7	mΩ
		V _{GS} =4.5V, I _D =20A		10.7	13.5	
g _{FS}	Forward Transconductance	V _{DS} =5V, I _D =20A		85		S
V _{SD}	Diode Forward Voltage	I _S =1A, V _{GS} =0V		0.72	1	V
I _S	Maximum Body-Diode Continuous Current				35	A
DYNAMIC PARAMETERS						
C _{ISS}	Input Capacitance	V _{GS} =0V, V _{DS} =30V, f=1MHz		2007		pF
C _{OSS}	Output Capacitance			177		pF
C _{RSS}	Reverse Transfer Capacitance			12.5		pF
R _g	Gate resistance	V _{GS} =0V, V _{DS} =0V, f=1MHz	0.6	1.2	1.8	Ω
SWITCHING PARAMETERS						
Q _{g(10V)}	Total Gate Charge	V _{GS} =10V, V _{DS} =30V, I _D =20A		20.6	30	nC
Q _{g(4.5V)}	Total Gate Charge			8.5	13	nC
Q _{gs}	Gate Source Charge			5		nC
Q _{gd}	Gate Drain Charge			2.2		nC
t _{D(on)}	Turn-On DelayTime	V _{GS} =10V, V _{DS} =30V, R _L =1.5Ω, R _{GEN} =3Ω		8.5		ns
t _r	Turn-On Rise Time			3.5		ns
t _{D(off)}	Turn-Off DelayTime			27		ns
t _f	Turn-Off Fall Time			3		ns
t _{rr}	Body Diode Reverse Recovery Time	I _F =20A, di/dt=500A/μs		19		ns
Q _{rr}	Body Diode Reverse Recovery Charge	I _F =20A, di/dt=500A/μs		69.5		nC

A. The value of R_{θJA} is measured with the device mounted on 1in² FR-4 board with 2oz. Copper, in a still air environment with T_A=25° C. The Power dissipation P_{DSM} is based on R_{θJA} and the maximum allowed junction temperature of 150° C. The value in any given application depends on the user's specific board design, and the maximum temperature of 175° C may be used if the PCB allows it.

B. The power dissipation P_D is based on T_{J(MAX)}=175° C, using junction-to-case thermal resistance, and is more useful in setting the upper dissipation limit for cases where additional heatsinking is used.

C. Repetitive rating, pulse width limited by junction temperature T_{J(MAX)}=175° C. Ratings are based on low frequency and duty cycles to keep initial T_J=25° C.

D. The R_{θJA} is the sum of the thermal impedance from junction to case R_{θJC} and case to ambient.

E. The static characteristics in Figures 1 to 6 are obtained using <300μs pulses, duty cycle 0.5% max.

F. These curves are based on the junction-to-case thermal impedance which is measured with the device mounted to a large heatsink, assuming a maximum junction temperature of T_{J(MAX)}=175° C. The SOA curve provides a single pulse rating.

G. The maximum current limited by package.

H. These tests are performed with the device mounted on 1 in² FR-4 board with 2oz. Copper, in a still air environment with T_A=25° C.

THIS PRODUCT HAS BEEN DESIGNED AND QUALIFIED FOR THE CONSUMER MARKET. APPLICATIONS OR USES AS CRITICAL COMPONENTS IN LIFE SUPPORT DEVICES OR SYSTEMS ARE NOT AUTHORIZED. AOS DOES NOT ASSUME ANY LIABILITY ARISING OUT OF SUCH APPLICATIONS OR USES OF ITS PRODUCTS. AOS RESERVES THE RIGHT TO IMPROVE PRODUCT DESIGN, FUNCTIONS AND RELIABILITY WITHOUT NOTICE.

TYPICAL ELECTRICAL AND THERMAL CHARACTERISTICS

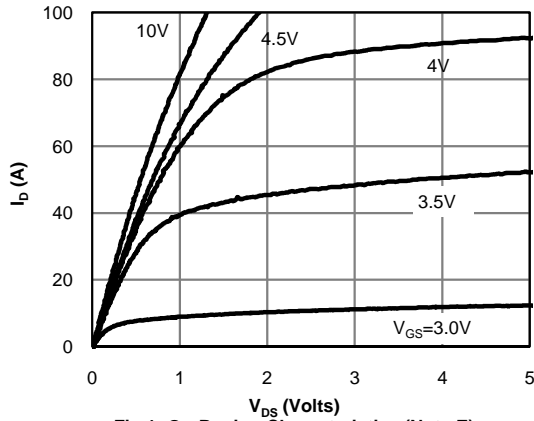

Fig 1: On-Region Characteristics (Note E)

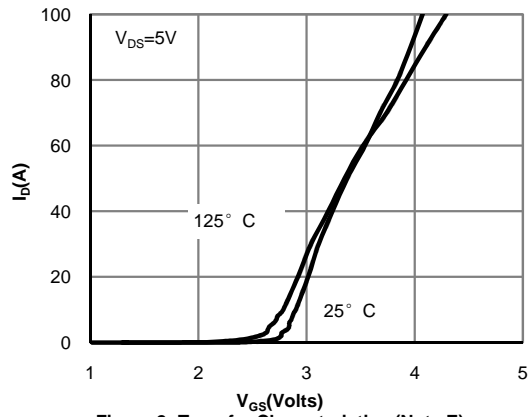

Figure 2: Transfer Characteristics (Note E)

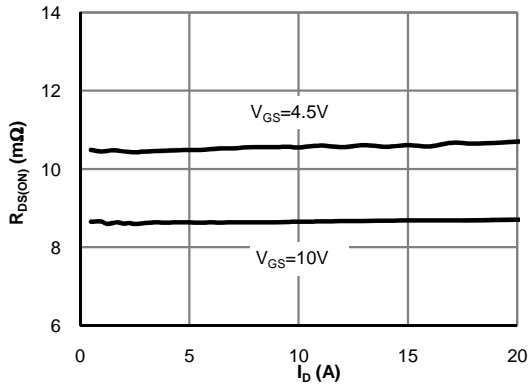

Figure 3: On-Resistance vs. Drain Current and Gate Voltage (Note E)

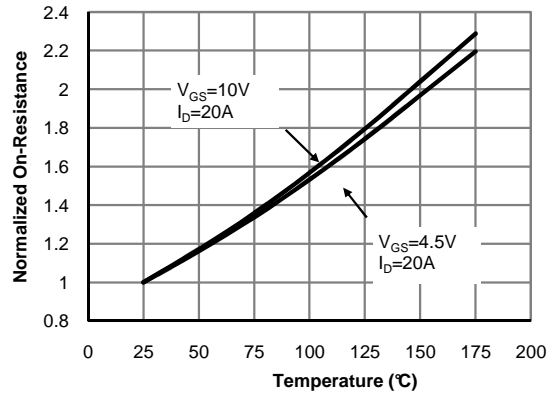

Figure 4: On-Resistance vs. Junction Temperature (Note E)

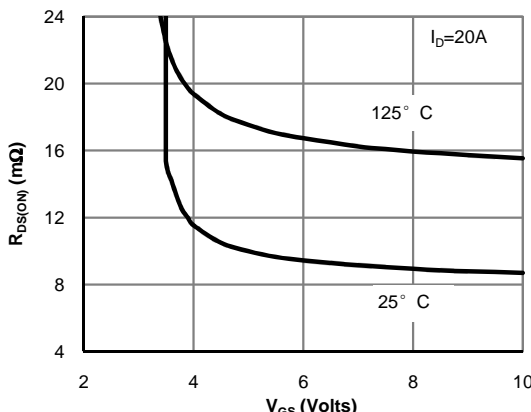

Figure 5: On-Resistance vs. Gate-Source Voltage (Note E)

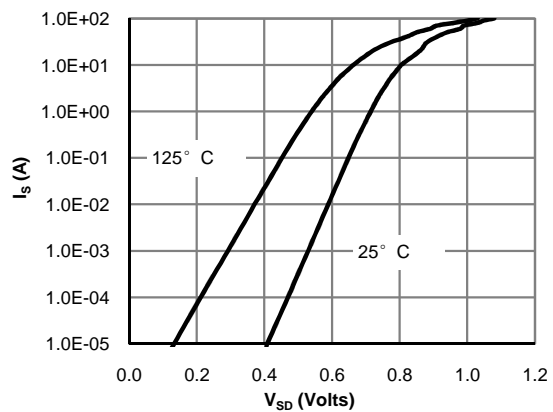

Figure 6: Body-Diode Characteristics (Note E)

TYPICAL ELECTRICAL AND THERMAL CHARACTERISTICS

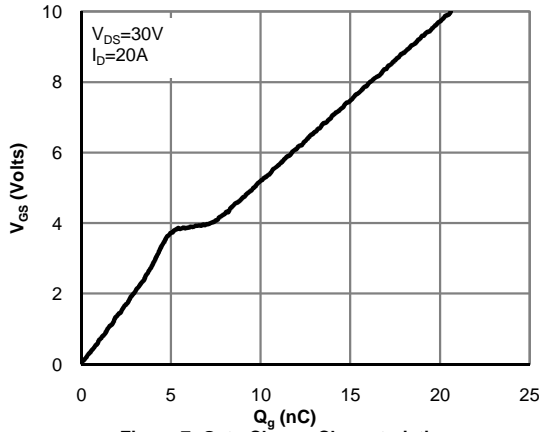

Figure 7: Gate-Charge Characteristics

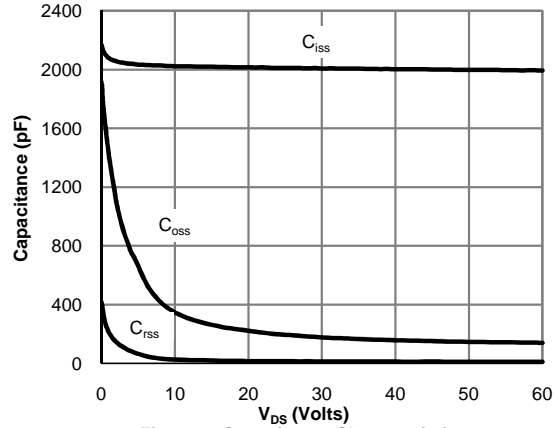

Figure 8: Capacitance Characteristics

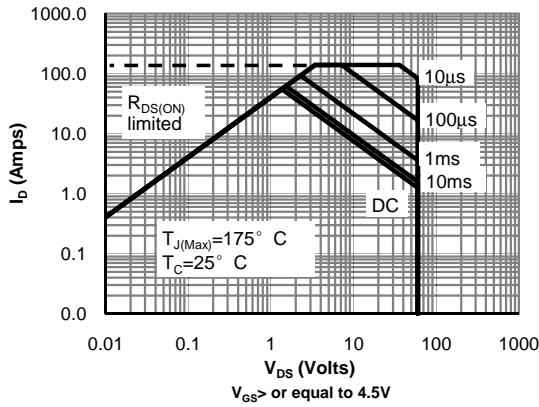

Figure 9: Maximum Forward Biased Safe Operating Area for AOT2610L (Note F)

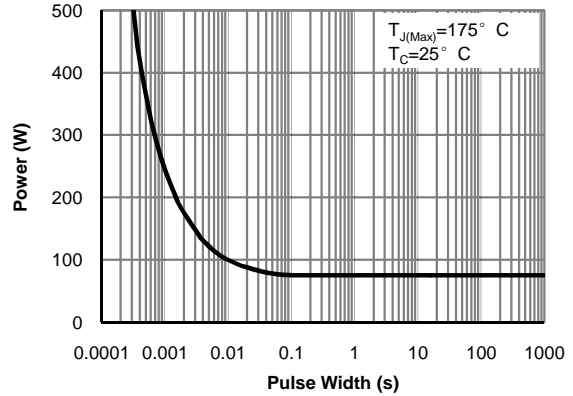

Figure 10: Single Pulse Power Rating Junction-to-Case for AOT2610L (Note F)

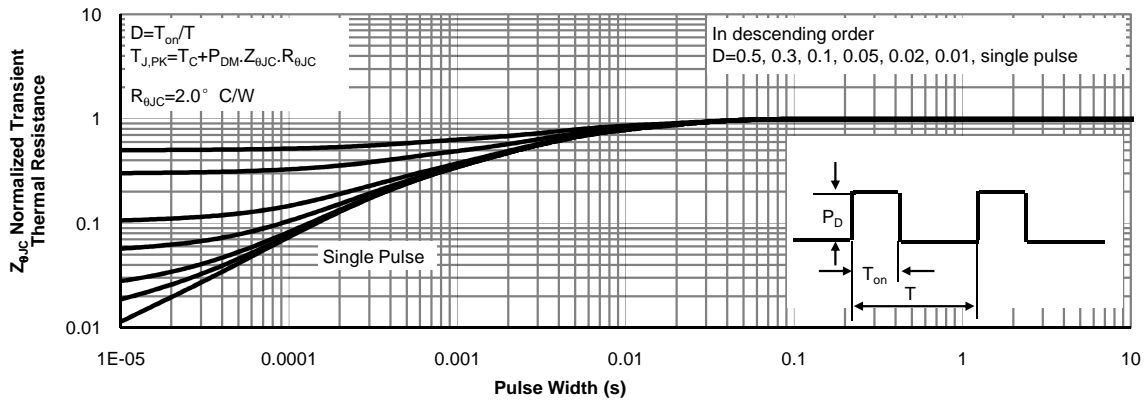

Figure 11: Normalized Maximum Transient Thermal Impedance for AOT2610L (Note F)

TYPICAL ELECTRICAL AND THERMAL CHARACTERISTICS

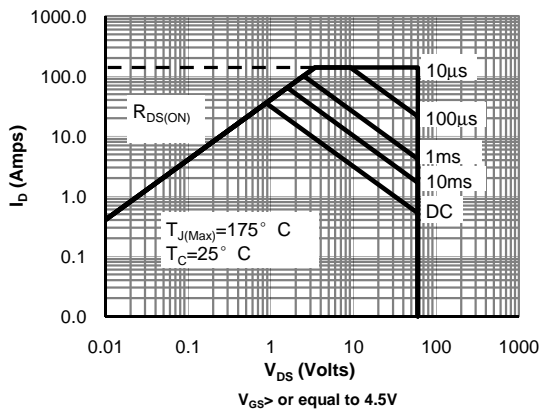

Figure 9: Maximum Forward Biased Safe Operating Area for AOTF2610L (Note F)

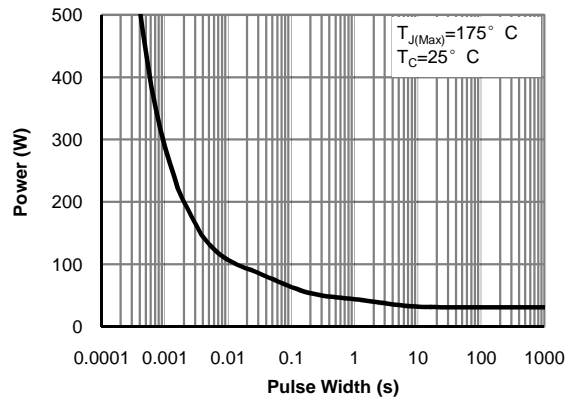

Figure 10: Single Pulse Power Rating Junction-to-Case for AOTF2610L (Note F)

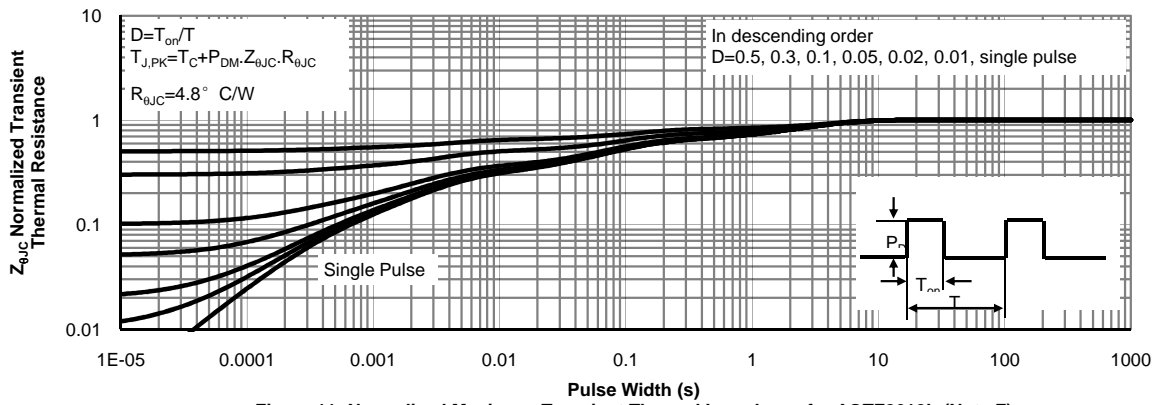

Figure 11: Normalized Maximum Transient Thermal Impedance for AOTF2610L (Note F)

TYPICAL ELECTRICAL AND THERMAL CHARACTERISTICS

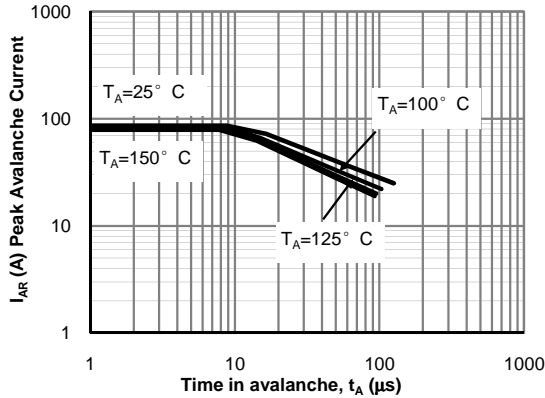

Figure 12: Single Pulse Avalanche capability (Note C)

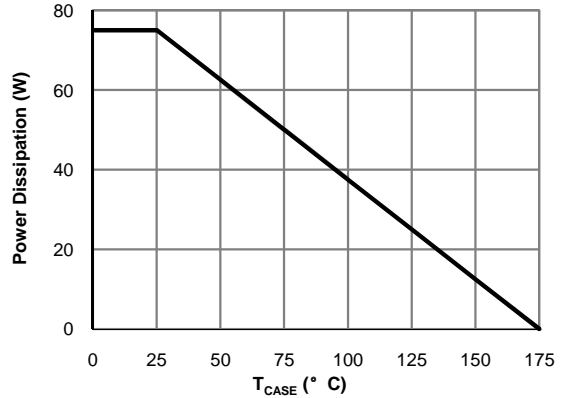

Figure 13: Power De-rating (Note F)

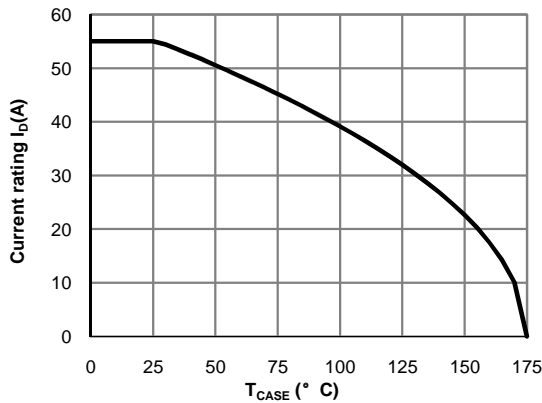

Figure 14: Current De-rating (Note F)

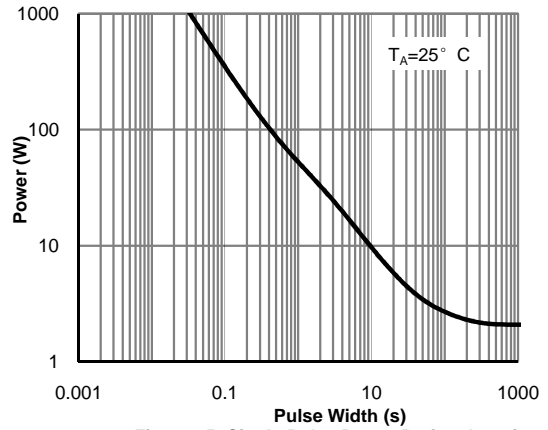

Figure 15: Single Pulse Power Rating Junction-to-Ambient (Note H)

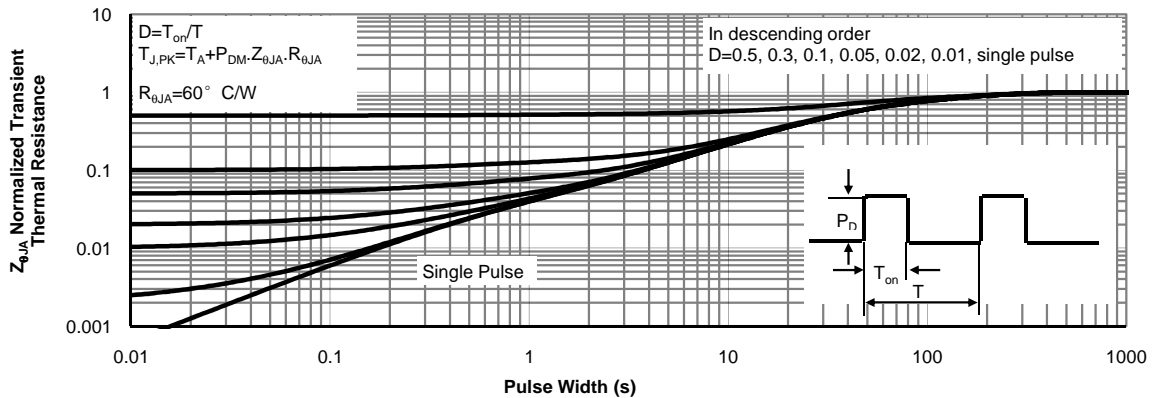
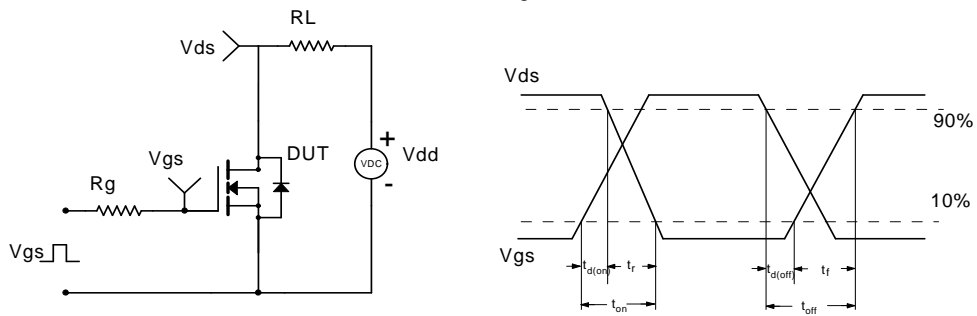

Figure 16: Normalized Maximum Transient Thermal Impedance (Note H)

Gate Charge Test Circuit & Waveform



Resistive Switching Test Circuit & Waveforms



Unclamped Inductive Switching (UIS) Test Circuit & Waveforms



Diode Recovery Test Circuit & Waveforms

