

NDS9430A Single P-Channel Enhancement Mode Field Effect Transistor

General Description

These P-Channel enhancement mode power field effect transistors are produced using National's proprietary, high cell density, DMOS technology. This very high density process is especially tailored to minimize on-state resistance, provide superior switching performance, and withstand high energy pulses in the avalanche and commutation modes. These devices are particularly suited for low voltage applications such as notebook computer power management and other battery powered circuits where fast switching, low in-line power loss, and resistance to transients are needed.

Features

- -5.3A, -20V. $R_{DS(ON)} = 0.05\Omega @ V_{GS} = -10V$
 $R_{DS(ON)} = 0.065\Omega @ V_{GS} = -6V$
 $R_{DS(ON)} = 0.09\Omega @ V_{GS} = -4.5V.$
- High density cell design for extremely low $R_{DS(ON)}$.
- High power and current handling capability in a widely used surface mount package.

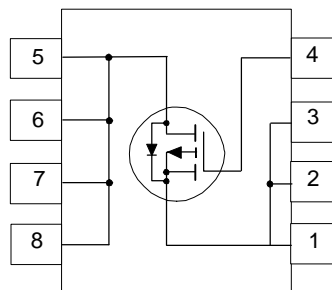
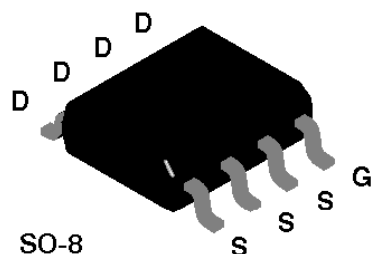

Absolute Maximum Ratings $T_A = 25^\circ\text{C}$ unless otherwise noted

| Symbol | Parameter | NDS9430A | Units |
|----------------|---|------------|------------------|
| V_{DSS} | Drain-Source Voltage | -20 | V |
| V_{GSS} | Gate-Source Voltage | ± 20 | V |
| I_D | Drain Current - Continuous (Note 1a) | ± 5.3 | A |
| | - Pulsed | ± 20 | |
| P_D | Maximum Power Dissipation (Note 1a) | 2.5 | W |
| | (Note 1b) | 1.2 | |
| | (Note 1c) | 1 | |
| T_J, T_{STG} | Operating and Storage Temperature Range | -55 to 150 | $^\circ\text{C}$ |

THERMAL CHARACTERISTICS

| | | | |
|-----------------|---|----|--------------------|
| $R_{\theta JA}$ | Thermal Resistance, Junction-to-Ambient (Note 1a) | 50 | $^\circ\text{C/W}$ |
| $R_{\theta JC}$ | Thermal Resistance, Junction-to-Case (Note 1) | 25 | $^\circ\text{C/W}$ |

Electrical Characteristics ($T_A = 25^\circ\text{C}$ unless otherwise noted)

| Symbol | Parameter | Conditions | Min | Typ | Max | Units |
|---|-----------------------------------|--|------|-------|-------|---------------|
| OFF CHARACTERISTICS | | | | | | |
| BV_{DSS} | Drain-Source Breakdown Voltage | $V_{GS} = 0\text{ V}, I_D = -250\ \mu\text{A}$ | -20 | | | V |
| I_{DSS} | Zero Gate Voltage Drain Current | $V_{DS} = -16\text{ V}, V_{GS} = 0\text{ V}$ | | | -1 | μA |
| | | $V_{DS} = -10\text{ V}, V_{GS} = 0\text{ V}$ $T_J = 70^\circ\text{C}$ | | | -5 | μA |
| I_{GSSF} | Gate - Body Leakage, Forward | $V_{GS} = 20\text{ V}, V_{DS} = 0\text{ V}$ | | | 100 | nA |
| I_{GSSR} | Gate - Body Leakage, Reverse | $V_{GS} = -20\text{ V}, V_{DS} = 0\text{ V}$ | | | -100 | nA |
| ON CHARACTERISTICS (Note 2) | | | | | | |
| $V_{GS(th)}$ | Gate Threshold Voltage | $V_{DS} = V_{GS}, I_D = -250\ \mu\text{A}$ | -1 | -1.4 | -3 | V |
| | | $T_J = 125^\circ\text{C}$ | -0.7 | -1 | -2 | |
| $R_{DS(on)}$ | Static Drain-Source On-Resistance | $V_{GS} = -10\text{ V}, I_D = -5.3\text{ A}$ | | 0.038 | 0.05 | Ω |
| | | $T_J = 125^\circ\text{C}$ | | 0.054 | 0.1 | |
| | | $V_{GS} = -6\text{ V}, I_D = -4.7\text{ A}$ | | 0.046 | 0.065 | |
| | | $V_{GS} = -4.5\text{ V}, I_D = -4.2\text{ A}$ | | 0.064 | 0.09 | |
| $I_{D(on)}$ | On-State Drain Current | $V_{GS} = -10\text{ V}, V_{DS} = -5\text{ V}$ | -15 | | | A |
| | | $V_{GS} = -4.5, V_{DS} = -5\text{ V}$ | -3.6 | | | |
| g_{FS} | Forward Transconductance | $V_{DS} = 15\text{ V}, I_D = 5.3\text{ A}$ | | 10 | | S |
| DYNAMIC CHARACTERISTICS | | | | | | |
| C_{iss} | Input Capacitance | $V_{DS} = 15\text{ V}, V_{GS} = 0\text{ V},$ $f = 1.0\text{ MHz}$ | | 950 | | pF |
| C_{oss} | Output Capacitance | | | 610 | | pF |
| C_{rss} | Reverse Transfer Capacitance | | | 220 | | pF |
| SWITCHING CHARACTERISTICS (Note 2) | | | | | | |
| $t_{D(on)}$ | Turn - On Delay Time | $V_{DD} = -10\text{ V}, I_D = -1\text{ A},$ $V_{GEN} = -10\text{ V}, R_{GEN} = 6\ \Omega$ | | 10 | 30 | ns |
| t_r | Turn - On Rise Time | | | 18 | 60 | ns |
| $t_{D(off)}$ | Turn - Off Delay Time | | | 80 | 120 | ns |
| t_f | Turn - Off Fall Time | | | 45 | 100 | ns |
| Q_g | Total Gate Charge | $V_{DS} = -10\text{ V},$ $I_D = -5.3\text{ A}, V_{GS} = -10\text{ V}$ | | 29 | 50 | nC |
| Q_{gs} | Gate-Source Charge | | | 3 | | nC |
| Q_{gd} | Gate-Drain Charge | | | 9 | | nC |

Electrical Characteristics ($T_A = 25^\circ\text{C}$ unless otherwise noted)

| Symbol | Parameter | Conditions | Min | Typ | Max | Units |
|---|---|--|-----|-------|------|-------|
| DRAIN-SOURCE DIODE CHARACTERISTICS AND MAXIMUM RATINGS | | | | | | |
| I_S | Maximum Continuous Drain-Source Diode Forward Current | | | | -2.1 | A |
| V_{SD} | Drain-Source Diode Forward Voltage | $V_{GS} = 0\text{ V}$, $I_S = -2.4\text{ A}$ (Note 2) | | -0.85 | -1.2 | V |
| t_{rr} | Reverse Recovery Time | $V_{GS} = 0\text{ V}$, $I_F = -2.4\text{ A}$, $dI_F/dt = 100\text{ A}/\mu\text{s}$ | | | 100 | ns |

Notes:

- $R_{\theta JA}$ is the sum of the junction-to-case and case-to-ambient thermal resistance where the case thermal reference is defined as the solder mounting surface of the drain pins. $R_{\theta JC}$ is guaranteed by design while $R_{\theta CA}$ is determined by the user's board design.

$$P_D(t) = \frac{T_J - T_A}{R_{\theta J A}(t)} = \frac{T_J - T_A}{R_{\theta J C} + R_{\theta CA}(t)} = I_D^2(t) \times R_{DS(on)} @ T_J$$

Typical $R_{\theta JA}$ using the board layouts shown below on 4.5"x5" FR-4 PCB in a still air environment:

- 50°C/W when mounted on a 1 in² pad of 2oz copper.
- 105°C/W when mounted on a 0.04 in² pad of 2oz copper.
- 125°C/W when mounted on a 0.006 in² pad of 2oz copper.

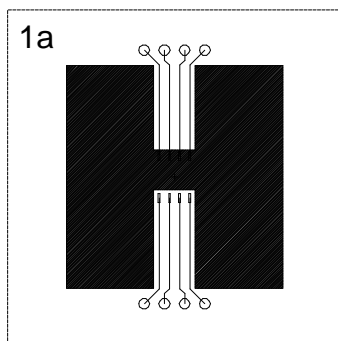

Scale 1 : 1 on letter size paper

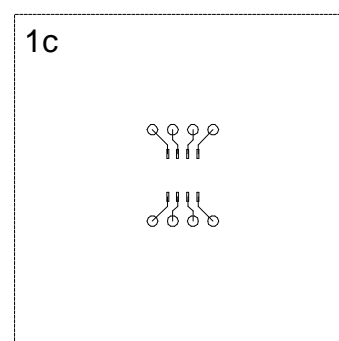
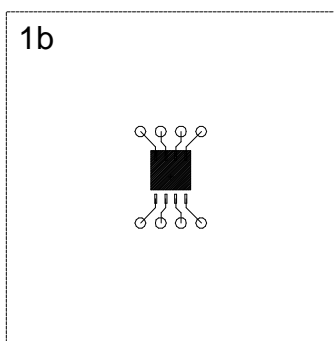

- Pulse Test: Pulse Width $\leq 300\mu\text{s}$, Duty Cycle $\leq 2.0\%$.

Typical Electrical Characteristics

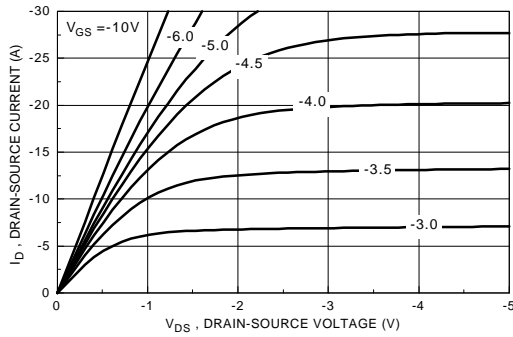

Figure 1. On-Region Characteristics

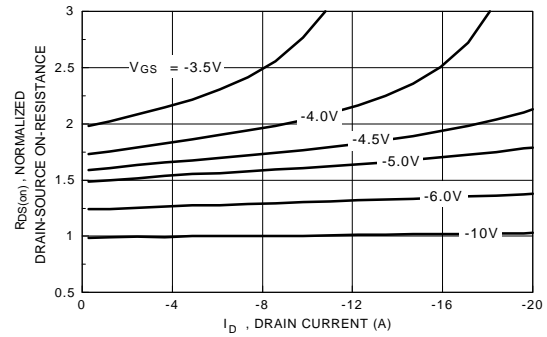

Figure 2. On-Resistance Variation with Drain Current and Gate Voltage

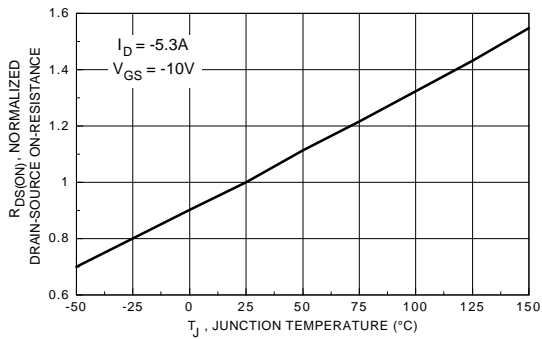

Figure 3. On-Resistance Variation with Temperature

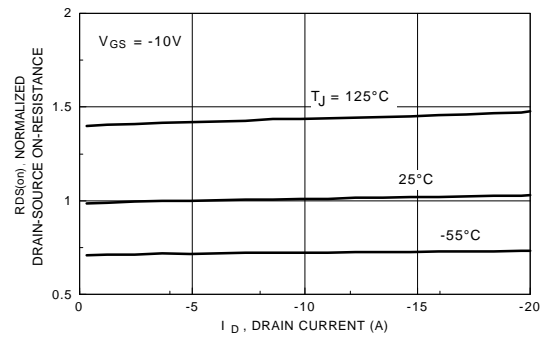

Figure 4. On-Resistance Variation with Drain Current and Temperature

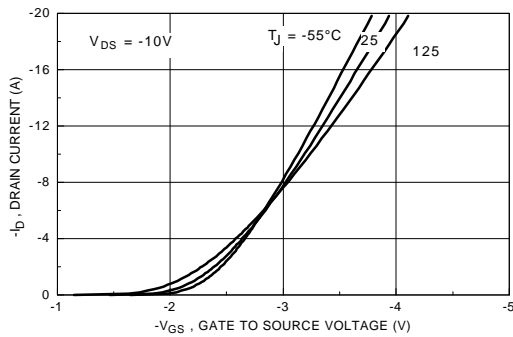

Figure 5. Transfer Characteristics

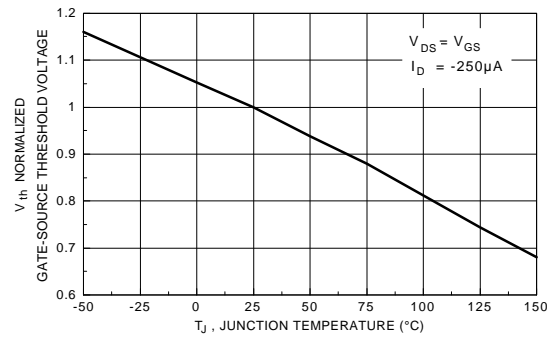

Figure 6. Gate Threshold Variation with Temperature

Typical Electrical Characteristics (continued)

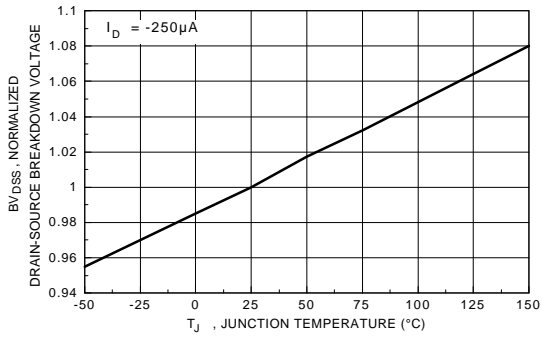

Figure 7. Breakdown Voltage Variation with Temperature

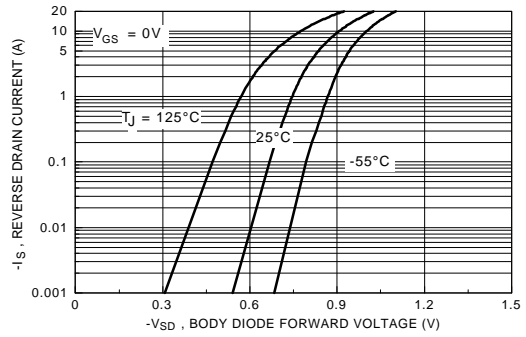

Figure 8. Body Diode Forward Voltage Variation with Source Current and Temperature

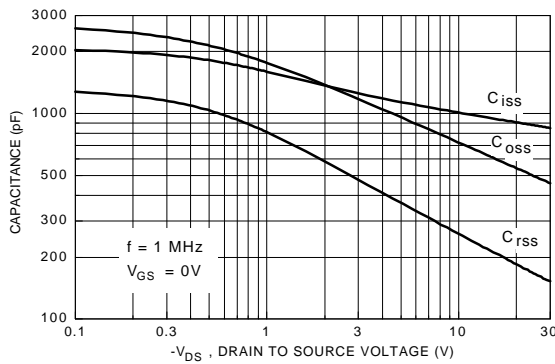

Figure 9. Capacitance Characteristics

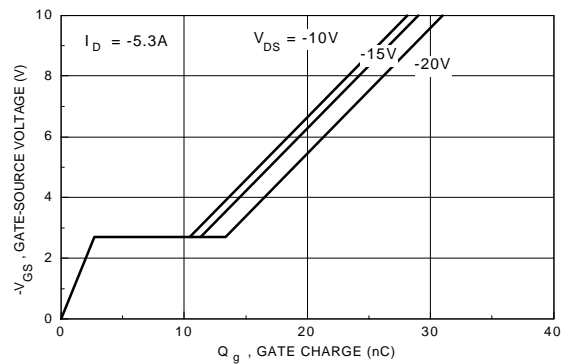

Figure 10. Gate Charge Characteristics

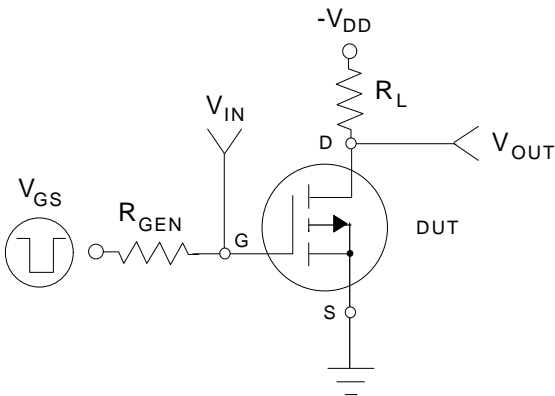

Figure 11. Switching Test Circuit

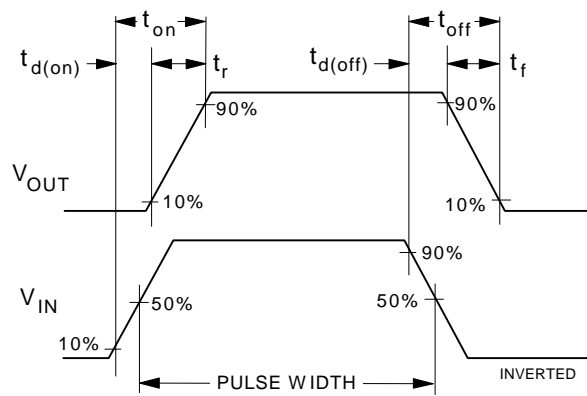

Figure 12. Switching Waveforms

Typical Electrical and Thermal Characteristics (continued)

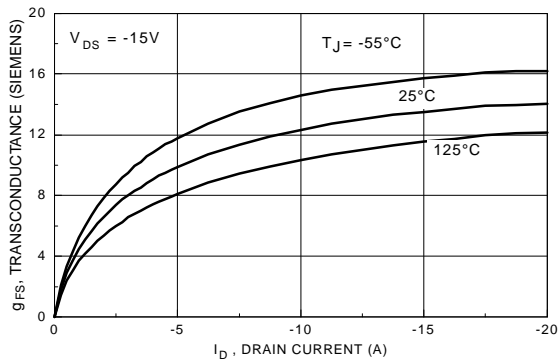

Figure 13. Transconductance Variation with Drain Current and Temperature

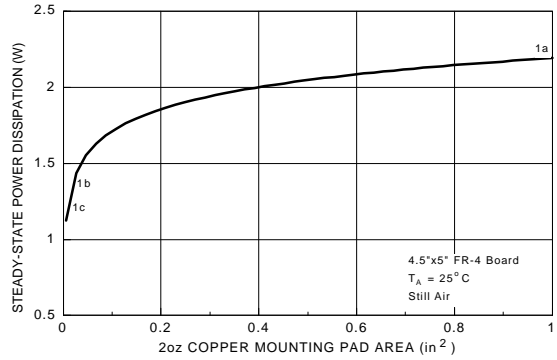

Figure 14. SO-8 Maximum Steady-State Power Dissipation versus Copper Mounting Pad Area.

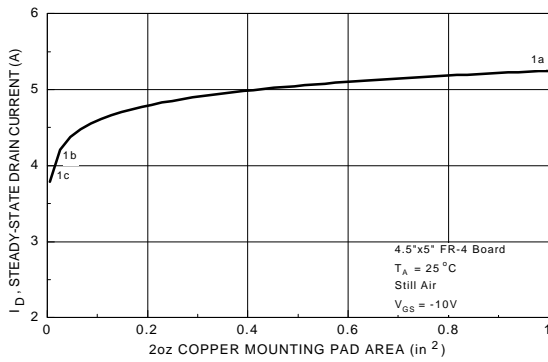

Figure 15. Maximum Steady-State Drain Current versus Copper Mounting Pad Area.

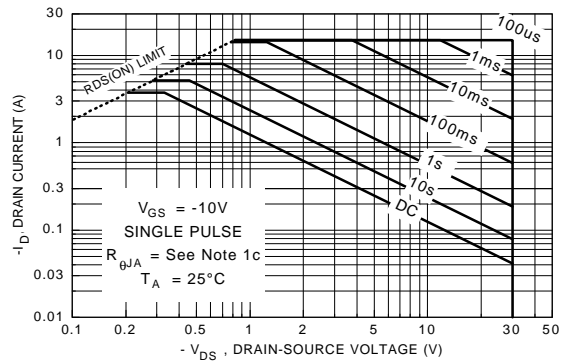

Figure 16. Maximum Safe Operating Area

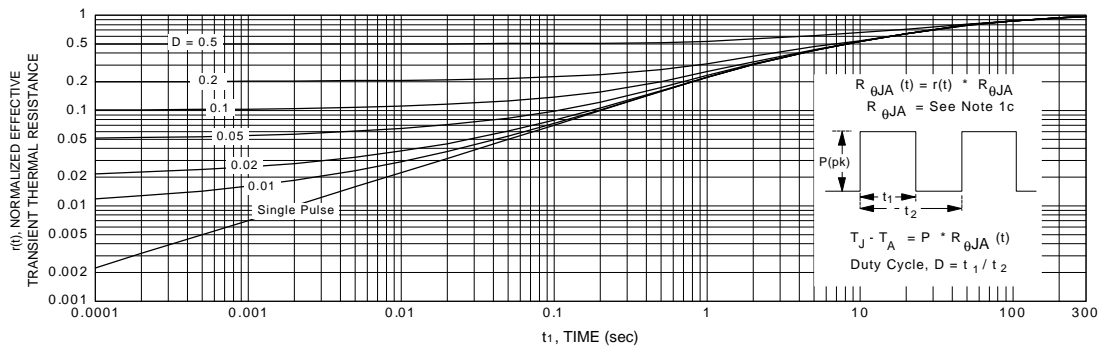

Figure 17. Transient Thermal Response Curve.

Note: Thermal characterization performed using the conditions described in note 1c. Transient thermal response will change depending on the circuit board design.

TRADEMARKS

The following are registered and unregistered trademarks Fairchild Semiconductor owns or is authorized to use and is not intended to be an exhaustive list of all such trademarks.

| | | | | |
|-----------------------------------|----------------------------------|----------------------------------|------------------------------|-------------------|
| ACE _x TM | FAST [®] | OPTOLOGIC TM | SMART START TM | VCX TM |
| Bottomless TM | FAST _r TM | OPTOPLANAR TM | STAR*POWER TM | |
| CoolFET TM | FRFET TM | PACMAN TM | Stealth TM | |
| CROSSVOLT TM | GlobalOptoisolator TM | POP TM | SuperSOT TM -3 | |
| DenseTrench TM | GTO TM | Power247 TM | SuperSOT TM -6 | |
| DOMET TM | HiSeC TM | PowerTrench [®] | SuperSOT TM -8 | |
| EcoSPARK TM | ISOPLANAR TM | QFET TM | SyncFET TM | |
| E ² CMOS TM | LittleFET TM | QS TM | TinyLogic TM | |
| EnSigna TM | MicroFET TM | QT Optoelectronics TM | TruTranslation TM | |
| FACT TM | MicroPak TM | Quiet Series TM | UHC TM | |
| FACT Quiet Series TM | MICROWIRE TM | SILENT SWITCHER [®] | UltraFET [®] | |

STAR*POWER is used under license

DISCLAIMER

FAIRCHILD SEMICONDUCTOR RESERVES THE RIGHT TO MAKE CHANGES WITHOUT FURTHER NOTICE TO ANY PRODUCTS HEREIN TO IMPROVE RELIABILITY, FUNCTION OR DESIGN. FAIRCHILD DOES NOT ASSUME ANY LIABILITY ARISING OUT OF THE APPLICATION OR USE OF ANY PRODUCT OR CIRCUIT DESCRIBED HEREIN; NEITHER DOES IT CONVEY ANY LICENSE UNDER ITS PATENT RIGHTS, NOR THE RIGHTS OF OTHERS.

LIFE SUPPORT POLICY

FAIRCHILD'S PRODUCTS ARE NOT AUTHORIZED FOR USE AS CRITICAL COMPONENTS IN LIFE SUPPORT DEVICES OR SYSTEMS WITHOUT THE EXPRESS WRITTEN APPROVAL OF FAIRCHILD SEMICONDUCTOR CORPORATION.

As used herein:

1. Life support devices or systems are devices or systems which, (a) are intended for surgical implant into the body, or (b) support or sustain life, or (c) whose failure to perform when properly used in accordance with instructions for use provided in the labeling, can be reasonably expected to result in significant injury to the user.
2. A critical component is any component of a life support device or system whose failure to perform can be reasonably expected to cause the failure of the life support device or system, or to affect its safety or effectiveness.

PRODUCT STATUS DEFINITIONS

Definition of Terms

| Datasheet Identification | Product Status | Definition |
|--------------------------|------------------------|---|
| Advance Information | Formative or In Design | This datasheet contains the design specifications for product development. Specifications may change in any manner without notice. |
| Preliminary | First Production | This datasheet contains preliminary data, and supplementary data will be published at a later date. Fairchild Semiconductor reserves the right to make changes at any time without notice in order to improve design. |
| No Identification Needed | Full Production | This datasheet contains final specifications. Fairchild Semiconductor reserves the right to make changes at any time without notice in order to improve design. |
| Obsolete | Not In Production | This datasheet contains specifications on a product that has been discontinued by Fairchild semiconductor. The datasheet is printed for reference information only. |

Fairchild Semiconductor

SEARCH | [Parametric](#) | [Cross Reference](#)

space

Product Folders and

Applies

find products

[Home](#) >> [Find products](#) >>[Products groups](#)[Analog and Mixed](#)[Signal](#)[Discrete](#)[Interface](#)[Logic](#)[Microcontrollers](#)[Non-Volatile](#)[Memory](#)[Optoelectronics](#)[Markets and](#)[applications](#)[New products](#)[Product selection and](#)[parametric search](#)[Cross-reference](#)[search](#)[technical information](#)[buy products](#)[technical support](#)[my Fairchild](#)[company](#)

NDS9430A

Single P-Channel Enhancement Mode Field Effect Transistor

Contents

[General description](#) | [Features](#) | [Product status/pricing/package](#)

General description

These P-Channel enhancement mode power field effect transistors are produced using National's proprietary, high cell density, DMOS technology. This very high density process is especially tailored to minimize on-state resistance, provide superior switching performance, and withstand high energy pulses in the avalanche and commutation modes. These devices are particularly suited for low voltage applications such as notebook computer power management and other battery powered circuits where fast switching, low in-line power loss, and resistance to transients are needed.

[back to top](#)

Features

- -5.3 A, -20 V
 - $R_{DS(ON)} = 0.05\Omega$ @ $V_{GS} = -10$ V
 - $R_{DS(ON)} = 0.065\Omega$ @ $V_{GS} = -6$ V
 - $R_{DS(ON)} = 0.09\Omega$ @ $V_{GS} = -4.5$ V
- High performance trench technology for extremely low $R_{DS(ON)}$
- High power and current handling capability in a widely used surface mount package.

Datasheet

[Download this datasheet](#)

PDF

[e-mail this datasheet](#)

[E-]

This page [Print version](#)

Related Links

[Request samples](#)[Dotted line](#)[How to order products](#)[Dotted line](#)[Product Change Notices \(PCNs\)](#)[Dotted line](#)[Support](#)[Dotted line](#)[Distributor and field sales representatives](#)[Dotted line](#)[Quality and reliability](#)[Dotted line](#)[Design tools](#)

[back to top](#)

Product status/pricing/packaging

| Product | Product status | Pricing* | Package type | Leads | Package marking | Packing method |
|----------|-----------------|----------|--------------|-------|---------------------------|----------------|
| NDS9430A | Full Production | \$0.96 | SOIC | 8 | \$Y&Z&2&T NDS 9430A | TAPE REEL |

* 1,000 piece Budgetary Pricing

[back to top](#)

[Home](#) | [Find products](#) | [Technical information](#) | [Buy products](#) |
[Support](#) | [Company](#) | [Contact us](#) | [Site index](#) | [Privacy policy](#)

© Copyright 2002 Fairchild Semiconductor