

# Panasonic

ideas for life

2D CODE READING SENSOR

# PD60/65



**Robust Reading of 2D Codes.**  
For Direct Marking on Metal Parts.



2D Code Reading Sensor PD60/PD65  
ARCT1B270E '06.7

**New**

<http://www.nais-e.com/vision/>  
Panasonic... the new name for **NAIS**

Matsushita Electric Works, Ltd.

# Image detection capability improved by image correction using our new pre-processing functions and original decoding functions.

In manufacturing environments, 2D codes are used to record and store various kinds of data, using direct marking, as a method for product quality improvement and as a response to quality-related problems.

Panasonic has produced the PD60/PD65 to realize high accuracy in the highly problematic reading of the direct marking of 2D codes on metal parts.

## Main Characteristics

1. Realization of highly accurate reading using original algorithm
2. Industry's first\*1 oil-resistant construction (IP67G\*2), ensuring maintainability
3. 2 types of image storage functions (write to main unit memory, export from USB port)
4. Simple setup of even high-level functions using powerful software tool "PDTOOL"

PDTOOL can be downloaded free of charge from our Web site ([www.nais-e.com/vision/](http://www.nais-e.com/vision/)).

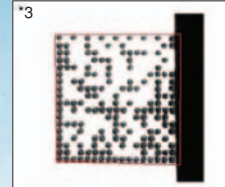
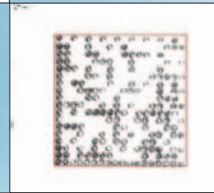
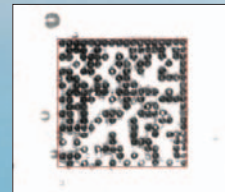

## 2D CODE READING SENSOR

# PD60

[Stationary Type]

Field of View	110mm: 12×10mm 200mm: 25×20mm
Integrated Light	White LED
Light Configuration	4 Control Sections
Protection Construction	IP67G *2
Read Method	Triggered by I/O
Pre-processing	FPGA Pre-processing + Software Pre-processing

## 2D CODE READING SENSOR

# PD65

[Handy Type]

Field of View	25×20mm
Integrated Light	White LED
Light Configuration	Dual Side Lighting/Diffuse Lighting
Protection Construction	IP67G *2
Read Method	Triggered by button push
Pre-processing	FPGA Pre-processing + Software Pre-processing

\*1 As of 25 May 2006 (as surveyed by Panasonic)

\*2 Fulfills IP67G only when USB connector cap is fitted.

\*3 Reads when Special Read is carried out. However, there are conditions under which reading is not possible.

# PD60



## 200mm Long Range.

A 200mm long range lens (ANPD060-25) is fitted out of consideration for the attachment locations possible with industrial equipment.

200mm

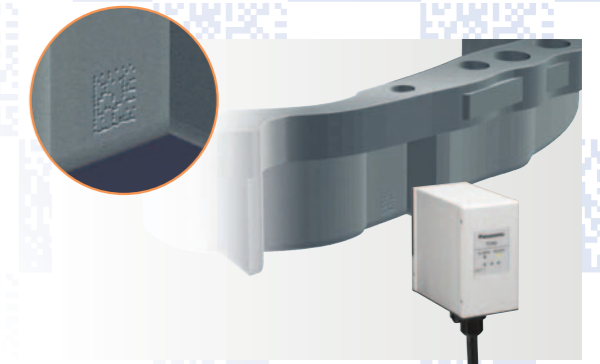

## Control of Lighting Possible

### Control of lighting sections.

Allows for stable reading regardless of variations in background, reflective properties and material quality of the marked object.

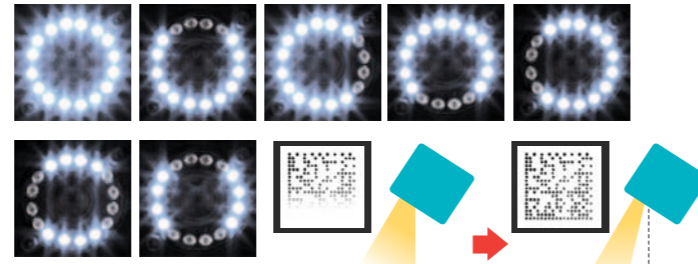

The lower part is too bright so uniformity is not possible and the image is not stable.

The lower light sections are turned off, the brightness becomes uniform and a stable reading can be taken.

## Oil-resistant construction (IP67G\*2) allows for peace-of-mind even in oily conditions.

Out of consideration for actual usage environments, we have created the industry's first oil-resistant construction (IP67G\*2) to allow peace-of-mind when using even with gloves covered in machine oil or detergent.

Industry's first.



# PD65

## Control of Lighting Possible

### Dual lighting

Reading under the optimum lighting conditions is made possible by the automatic light switching function, which switches between 2 lighting patterns to allow greater improvement of the accuracy of reading of direct marking.

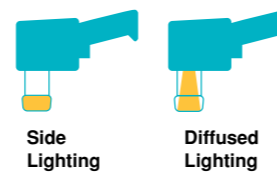

## Double Signal Notification

Whether reading is possible or not can be confirmed visually during operation.

- Ready to Read**  
Green Light + Buzzer
- Read Not Possible**  
Orange Light



Equipped with handy hook hole for hanging.

48mm

Contact Type

41.5mm

Read Button

Equipped with handy hook hole for hanging.



## Improved Reading Accuracy

Development of original algorithm with image processing technology cultivated over 20 years by MEW. We have greatly improved the accuracy of reading direct marking on metal, which is highly problematic for automatic reading, and greatly improved the image detection abilities with image correction using our new pre-processing functions and a new library.

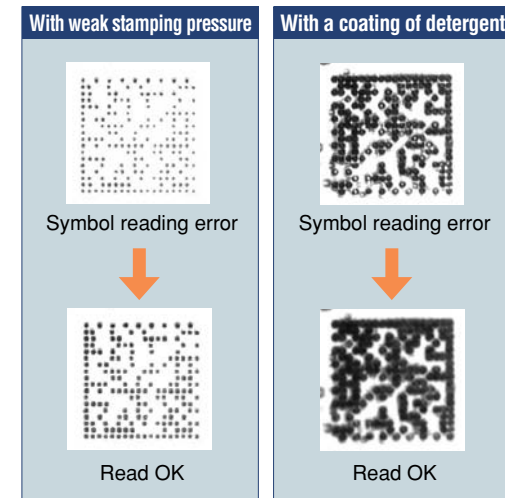

## Real-time Image Storage.

Realization of traceability. Images with read errors (or all images) can be stored in the main unit. In addition, using the free utility tool PDTOOL, images can be transferred to a PC and stored in specified folders in real time.

## Construction with Emphasis on Maintenance

Just in case some problem occurs with the product, the controller part and cable part are connected with an oil-resistant connector, allowing the controller part to be replaced immediately. This practical construction eliminates the need for troublesome cable tracing and re-laying and allows priority to be given to restoring the work environment.

## Advanced Oil-Resistant Construction (IP67G\*2)

With its oil-resistant capabilities, an industry first for a 2D code reader, the unit can be used with peace-of-mind even in automobile parts manufacturing environments (with engines, transmissions, etc.) in which machine oil and detergents are used.

## Dedicated Software Tool "PDTOOL" for Easy Setup

The software tool "PDTOOL" has been enhanced to allow settings to be made easily even with the more advanced functions. PDTOOL can be downloaded free-of-charge from our Web site.

Industry's first.



## Further Improvement of Decoding Capabilities with Pre-Processing Functions

In pre-processing, various original algorithms are applied to images of difficult-to-read 2D codes to improve their readability. In the past, read accuracy was improved for stamp errors (stained, chipped, tilted, flipped or black/white reversed codes) on hard-to-read metal surfaces.

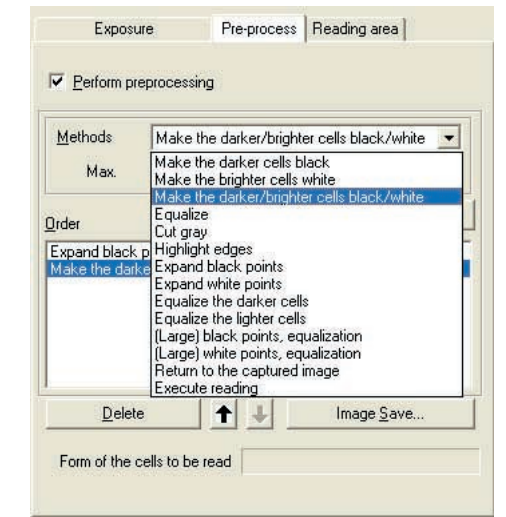
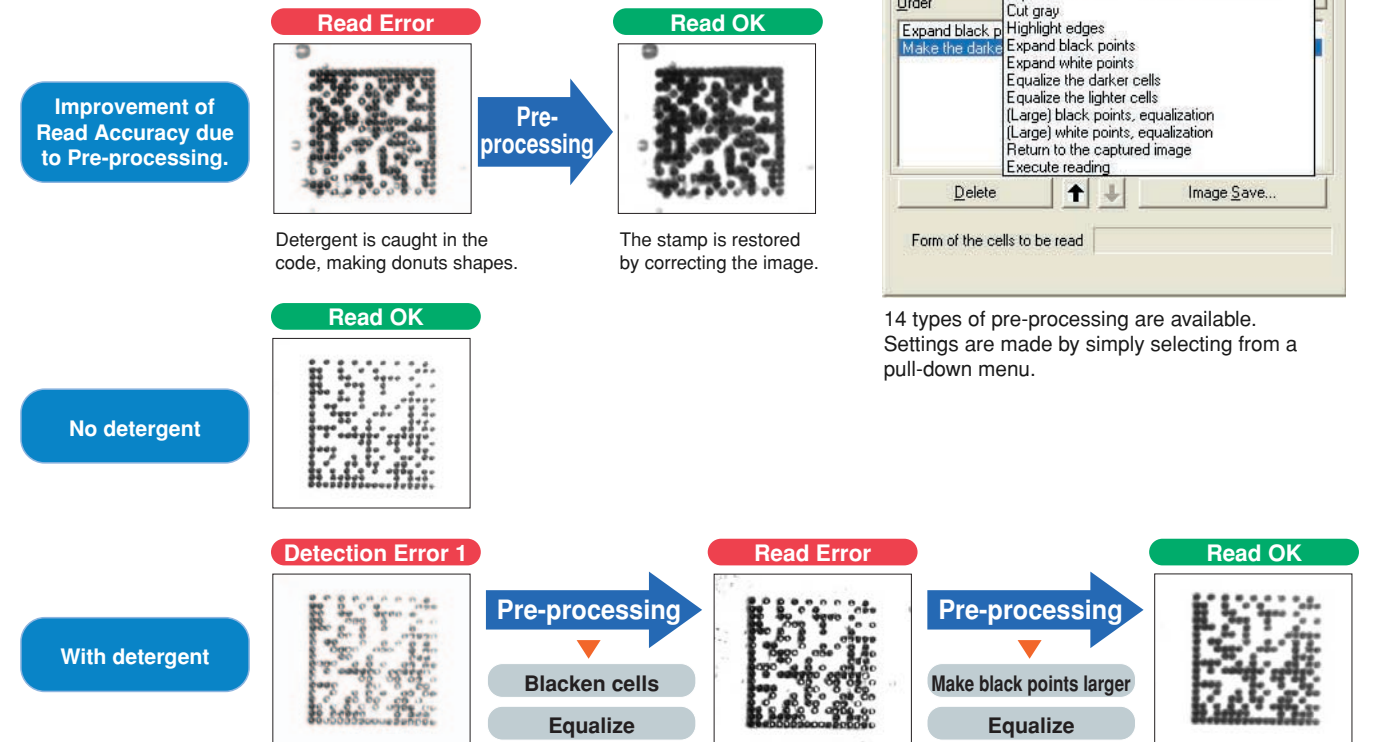

14 types of pre-processing are available. Settings are made by simply selecting from a pull-down menu.

## Guide light red LED enables easy fitting and installation

Two red-LED guide lights allow quick installation of the unit in the optimum position.

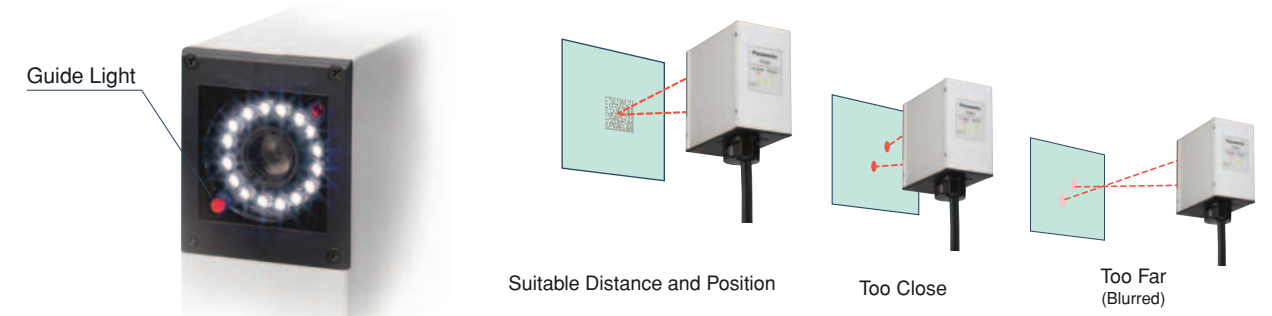

## Application

Supports 2D codes indicated on a great variety of applications

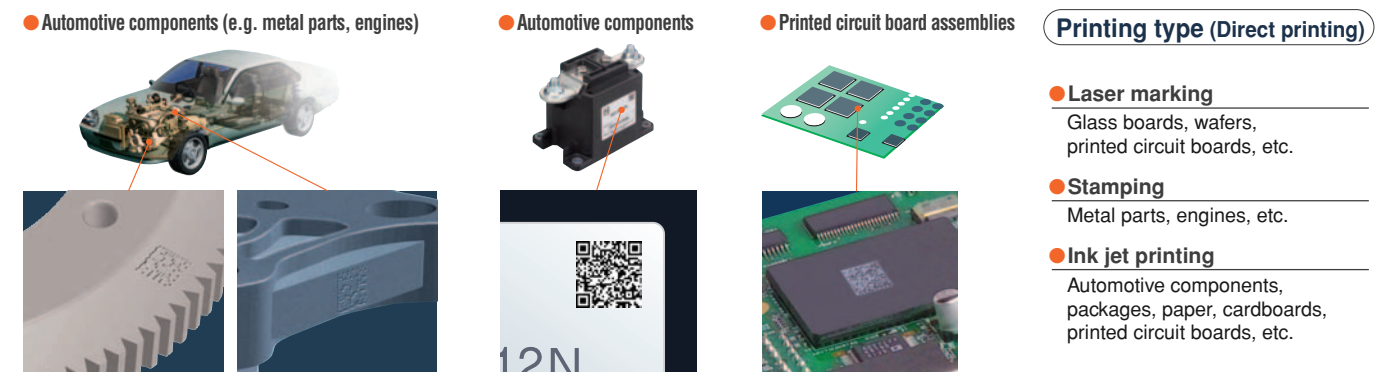

# Simple setup using the free software "PDTOOL".



PDTOOL provides the customer with 4 convenient functions

The latest version of PDTOOL, the setup software tool which aims at ease of use with multiple functions, is available for download from the Web.

**Simple Setup**  
One-step automatic settings

**Automatic exposure adjustment**  
Adjustment to the optimum exposure is also automatic.

**Real-time image display**  
Settings can be checked while looking at the actual image.

**Settings Help Display**

**One-step automatic setup**

**Screen Resolution**  
Free selection of part of image to be analyzed.  
Image display can be zoomed to 2x and 4x.  
Brightness distribution graph display

**Traceability**  
Record data is displayed as reading is carried out and read-in images and record data can also be saved.

**Settings Support**  
**Examine mode**  
Images undergoing read retry processing and read results can be saved on a PC.  
**Debug Mode**  
Image data saved in PDTOOL can be downloaded to the PD60 and settings made or read executed on the downloaded image, without having to acquire an image of a 2D code.

File name and link to saved images.

PDTOOL can be downloaded free of charge from our Web site [www.nais-e.com/vision/](http://www.nais-e.com/vision/)

## Interface

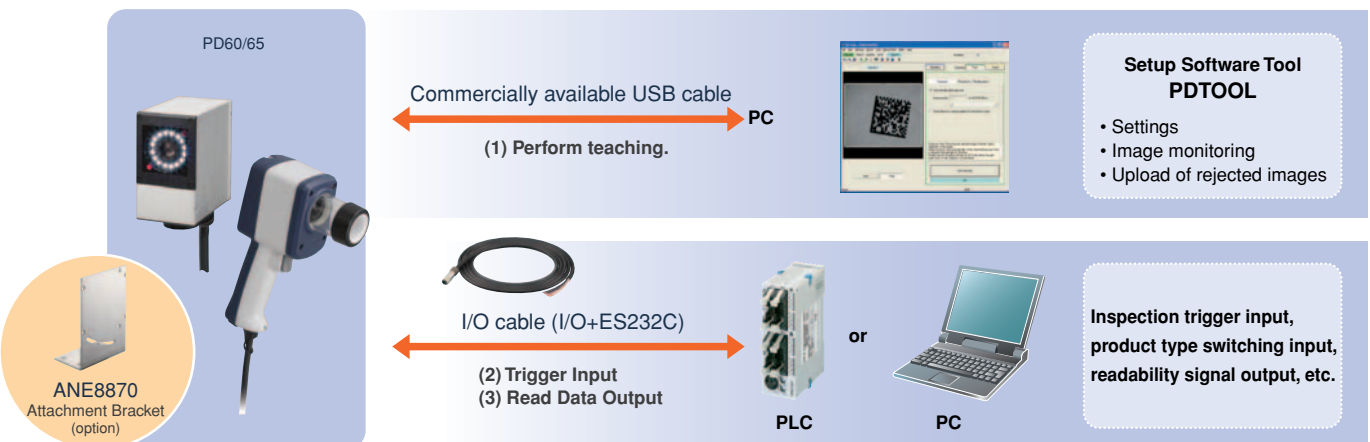

## Table of Order Numbers

Name	Part No.	Content
2D code reading sensor	PD60	ANPD060-12 Field of view: 12×10mm Installation distance: 110±5.5mm
		ANPD060-25 Field of view: 25×20mm Installation distance: 200±10mm
		ANPD060S25 Field of view: 25×20mm Installation distance: 105±5mm
	PD65	ANPD065-25 Field of view: 25×20mm Installation distance: Contact type (In 24.5 mm diameter guide pipe.)
Attachment Bracket	ANE8870	For mounting PD60
PDTOOL	—	Setup Software Tool Note: free download from our Web site
Extension Cable	ANPD068-03	3m
	ANPD068-05	5m
	ANPD068-10	10m
Options (repair parts)	ANPD068-P1	Set with PD60 front panel, packing, and stop screws.
	ANPD068-G1	Set with PD65 guide pipe, packing, and stop screws.
	ANPD068-K1	2700 mm power supply I/O cable for PD 60.

## General Specifications

### General Specifications

Item	Specification	
	PD60	PD65
Rated operating voltage	24 V DC	
Operating voltage range	21.6 to 26.4 V DC (including ripples)	
Rated current consumption	0.5 A max.	
Ambient temperature in use	0 to +40°C	
Storage ambient temperature	-20 to +60°C (no freezing or condensation)	
Ambient humidity in use	35 to 85%RH (at 25°C no freezing or condensation)	
Storage ambient humidity	35 to 85%RH (at 25°C no freezing or condensation)	
Noise immunity	1000 V pulse width 50 ns/1 μs (using noise simulator method)	
Vibration resistance	10 to 55 Hz, 1 sweep/min. Double amplitude of 1.5 mm. 30 min. each in X, Y and Z directions	
Shock resistance	196 m/s <sup>2</sup> , 5 times each in X, Y and Z directions	
Insulation resistance (initial)	Min. 100MΩ (with a 500 VDC isolation resistance tester) Note 1: Parallel input/parallel output, parallel input/power, parallel input/functional earth, parallel output/power, parallel output/functional earth, power/functional earth.	
Breakdown voltage (initial)	500V AC/1 minute (600V AC/1 second) Cut-off current 10mA Note 1: Parallel input/parallel output, parallel input/power, parallel input/functional earth, parallel output/power, parallel output/functional earth, power/functional earth.	
Protective Construction	IP67G Note 2:	
Mass Note 3:	Approx: 500 g	Approx: 700 g

Note \*1 Evaluation was carried out with the primary side power supply varistor and capacitor removed from the internal circuit of the device.

Note \*2 Evaluation was carried out with the USB cable not connected and the waterproof cap in place.

Note \*3 Weight includes power supply I/O cable.

### Options (repair parts)



## Function Specifications

### Main Unit

Item	Specification	
	PD60	PD65
Type	Stationary Type	Handy Type
Light Configuration	4 Control Sections	Dual Side/Diffused Lighting
Read Method	External Start, Auto start	Trigger button
Image capture element	Black/white C-MOS	
Valid pixels	352 horizontal × 288 vertical pixels (100,000 pixels)	
Image capture light source	White LED	
Expected life	Expected Life: Min. 30000 hours (until light intensity falls to 50%) (at 25°C, internal trigger: ON, read time: 60ms, exposure time: 3ms)	
	Exposure time	Shutter timing and interlock (0.03 to 50 ms)
Visual Pilot Beam	Red LED	
Input/Output	Parallel	Power I/O Cable
	Input	2 Photo-coupler Inputs (trigger: 1 bit, model switch: 1 bit)
	Output	3 PhotoMOS outputs (ready: 1 bit, alarm: 1 bit, OK/NG: 1 bit)
Serial	Power I/O cable (RS232C communication: Max. 57600 bit/s)	
USB	USB Cable (AB Type) Sold separately	
	PC I/P	USB1.1
	Supported OS	Windows® XP, 2000, Me, 98SE

### Application Software

Item	Specification		
	PD60	PD65	
Detection Capability	5 or more pixels per cell		
Total processing time	30 ms to 200 ms		
No. of Registered Items	7 types		
Type Registration Method	Teaching [settings related to codes to be decoded]		
Serial	Input	I/O Command	Trigger input, type switching (types 1 to 7)
		Teaching Command	Exposure time setting, and code setting (QR codes, data matrix)
	Output	Readability, readouts, error correction rate, and error output	
Parallel	Input	Trigger input, type switching (types 1 to 7) mode switching (teaching/RUN)	
	Output	Evaluation result (OK/NG), READY, Alarm	

\* The total processing time from receiving the trigger input to output varies with the exposure time and matrix size.

### 2D Code Reading

Item	Specification		
	PD60	PD65	
Readable code type	QR code	Model	Model 1 and Model 2
		Matrix size	Model 1: 21 × 21 cells to 49 × 49 cells (Ver. 1 to 8) Model 2: 21 × 21 cells to 49 × 49 cells (Ver. 1 to 8)
		Error correction level	L (7%), M (15%), Q (25%), H (30%)
	Data matrix (ECC200)	Matrix size	Square symbol: 10 × 10 cells to 44 × 44 cells matrix
			Rectangular symbol: 8 × 18 cells, 8 × 32 cells, 12 × 26 cells, 12 × 36 cells, 16 × 36 cells, 16 × 48 cells
Supports black/white reversed codes, horizontally-flipped codes, and dots. The model, matrix size, and the error correction level are automatically identified.			
Supports black/white reversed codes, horizontally-flipped codes, and dots. The matrix size is automatically identified.			

# Dimensions (Unit: mm)

● PD60  
ANPD060\*\*\*

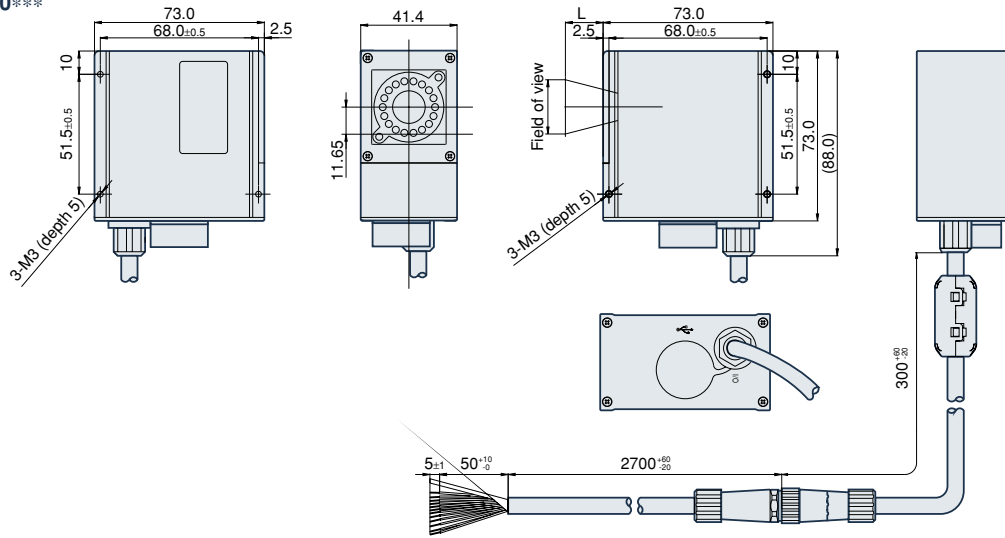

● PD65  
ANPD065-25

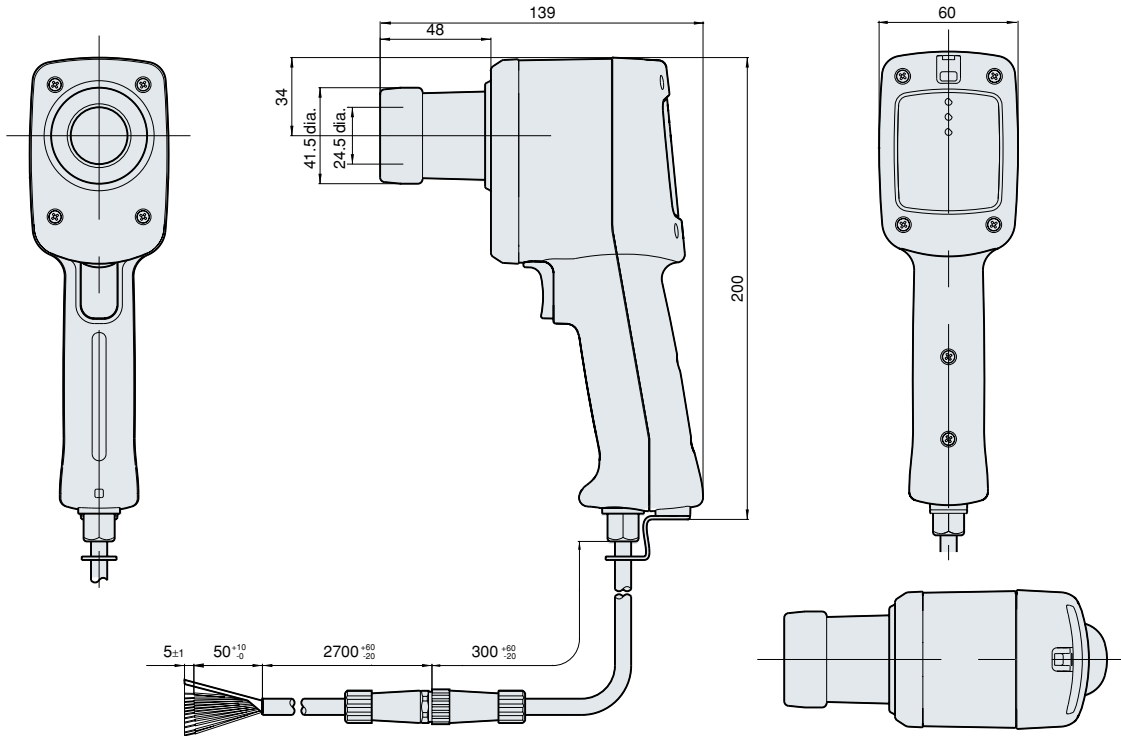

● PD60 front panel (option)  
ANPD068-P1

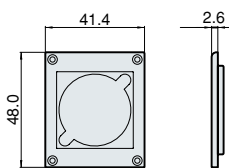

● PD65 Guide pipe (option)  
ANPD068-G1

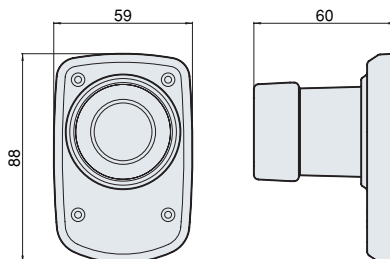

● PD60 Series power supply I/O cable (option)  
ANPD068-K1

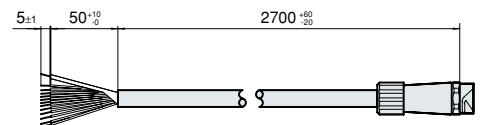

# Image Processing Device Lineup

## MICRO-IMAGECHECKER **PV310**

Ultra high-speed, gray scale image processing  
Full set of interfaces with CompactFlash card and Ethernet



## MICRO-IMAGECHECKER **A230**

Character recognition & character checker type



## MICRO-IMAGECHECKER **A110**

Multi-checker V2 series  
Compact-size, gray scale image processing  
(1-camera type)



## 2D Code Reading Sensor **PD50**

High accuracy, easy operation  
For 2D code reading



## MICRO-IMAGECHECKER **AX40**

Color and gray scale image processing  
Full set of interfaces with CF card and Ethernet



## MICRO-IMAGECHECKER **A210**

Multi-checker V2 series  
Compact-size, gray scale image processing  
(2-camera type)



## LightPix **AE20**

Visual sensor with lights, camera and CPU  
integrated into one unit  
Color area/color discrimination/color and pattern  
matching/edge detection/apex detection/size measurement



## 2D Code Reading Sensor **PD60/PD65**

Highly accurate, simple operation, IP67G  
For reading stamped direct marking 2D codes.



(Stationary Type) (Handy Type)

These materials are printed on ECF pulp.  
These materials are printed with earth-friendly vegetable-based (soybean oil) ink.



Please contact .....

## Matsushita Electric Works, Ltd.

Automation Controls Business Unit

■ Head Office: 1048, Kadoma, Kadoma-shi, Osaka 571-8686, Japan

■ Telephone: +81-6-6908-1050 ■ Facsimile: +81-6-6908-5781

<http://www.nais-e.com/>

# Panasonic®

All Rights Reserved © 2006 COPYRIGHT Matsushita Electric Works, Ltd.