

# ON Semiconductor

## Is Now

# onsemi™

To learn more about onsemi™, please visit our website at  
[www.onsemi.com](http://www.onsemi.com)

---

**onsemi** and **onsemi** and other names, marks, and brands are registered and/or common law trademarks of Semiconductor Components Industries, LLC dba "**onsemi**" or its affiliates and/or subsidiaries in the United States and/or other countries. **onsemi** owns the rights to a number of patents, trademarks, copyrights, trade secrets, and other intellectual property. A listing of **onsemi** product/patent coverage may be accessed at [www.onsemi.com/site/pdf/Patent-Marking.pdf](http://www.onsemi.com/site/pdf/Patent-Marking.pdf). **onsemi** reserves the right to make changes at any time to any products or information herein, without notice. The information herein is provided "as-is" and **onsemi** makes no warranty, representation or guarantee regarding the accuracy of the information, product features, availability, functionality, or suitability of its products for any particular purpose, nor does **onsemi** assume any liability arising out of the application or use of any product or circuit, and specifically disclaims any and all liability, including without limitation special, consequential or incidental damages. Buyer is responsible for its products and applications using **onsemi** products, including compliance with all laws, regulations and safety requirements or standards, regardless of any support or applications information provided by **onsemi**. "Typical" parameters which may be provided in **onsemi** data sheets and/or specifications can and do vary in different applications and actual performance may vary over time. All operating parameters, including "Typicals" must be validated for each customer application by customer's technical experts. **onsemi** does not convey any license under any of its intellectual property rights nor the rights of others. **onsemi** products are not designed, intended, or authorized for use as a critical component in life support systems or any FDA Class 3 medical devices or medical devices with a same or similar classification in a foreign jurisdiction or any devices intended for implantation in the human body. Should Buyer purchase or use **onsemi** products for any such unintended or unauthorized application, Buyer shall indemnify and hold **onsemi** and its officers, employees, subsidiaries, affiliates, and distributors harmless against all claims, costs, damages, and expenses, and reasonable attorney fees arising out of, directly or indirectly, any claim of personal injury or death associated with such unintended or unauthorized use, even if such claim alleges that **onsemi** was negligent regarding the design or manufacture of the part. **onsemi** is an Equal Opportunity/Affirmative Action Employer. This literature is subject to all applicable copyright laws and is not for resale in any manner. Other names and brands may be claimed as the property of others.

# AFGB30T65SQDN

## IGBT for Automotive Applications

650 V, 30 A, D<sup>2</sup>PAK

### Features

- Maximum Junction Temperature:  $T_J = 175^\circ\text{C}$
- High Speed Switching Series
- $V_{CE(sat)} = 1.6\text{ V (typ.) @ } I_C = 30\text{ A}$
- Low VF Soft Recovery Co-packaged Diode
- AEC-Q101 Qualified
- 100% of the Parts are Dynamically Tested (Note 1)

### Typical Applications

- Automotive On Board Charger
- Automotive DC/DC Converter for HEV

### MAXIMUM RATINGS ( $T_C = 25^\circ\text{C}$ unless otherwise stated)

Parameter	Symbol	Value	Unit
Collector-to-Emitter Voltage	$V_{CES}$	650	V
Gate-to-Emitter Voltage	$V_{GES}$	$\pm 20$	V
Transient Gate-to-Emitter Voltage	$V_{GES}$	$\pm 30$	V
Collector Current ( $T_C = 25^\circ\text{C}$ )	$I_C$	60	A
Collector Current ( $T_C = 100^\circ\text{C}$ )		30	A
Pulsed Collector Current (Note 2)	$I_{CM}$	120	A
Diode Forward Current ( $T_C = 25^\circ\text{C}$ )	$I_F$	40	A
Diode Forward Current ( $T_C = 100^\circ\text{C}$ )		20	A
Pulsed Diode Maximum Forward Current (Note 2)	$I_{FM}$	120	A
Maximum Power Dissipation ( $T_C = 25^\circ\text{C}$ )	$P_D$	220	W
Maximum Power Dissipation ( $T_C = 100^\circ\text{C}$ )		110	W
Operating Junction and Storage Temperature Range	$T_J, T_{STG}$	-55 to +175	$^\circ\text{C}$

Stresses exceeding those listed in the Maximum Ratings table may damage the device. If any of these limits are exceeded, device functionality should not be assumed, damage may occur and reliability may be affected.

1.  $V_{CC} = 400\text{ V}, V_{GE} = 15\text{ V}, I_C = 90\text{ A}, R_G = 100\ \Omega$ , Inductive Load
2. Repetitive rating: pulse width limited by max. Junction temperature
3. Surface-mounted on FR4 board using  $1\text{ in}^2$  pad size, 1 oz Cu pad.
4. The entire application environment impacts the thermal resistance values shown, they are not constants and are only valid for the particular conditions noted.



ON Semiconductor®

[www.onsemi.com](http://www.onsemi.com)

$BV_{CES}$	$V_{CE(sat)}$ TYP	$I_C$ MAX
650 V	1.6 V	120 A

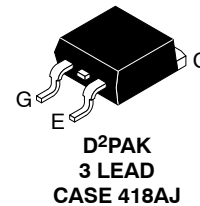
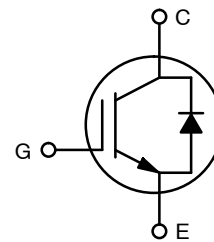

### MARKING DIAGRAM



- &Y = ON Semiconductor Logo
- &Z = Assembly Plant Code
- &3 = 3-Digit Date Code
- &K = 2-Digit Lot Traceability Code
- AFGB30T65SQDN = Specific Device Code

### ORDERING INFORMATION

Device	Package	Shipping†
AFGB30T65SQDN	D2PAK (TO-263)	800 Units / Tape & Reel

†For information on tape and reel specifications, including part orientation and tape sizes, please refer to our Tape and Reel Packaging Specification Brochure, BRD8011/D.

# AFGB30T65SQDN

**Table 1. THERMAL RESISTANCE RATINGS**

Parameter	Symbol	Max	Unit
Thermal Resistance Junction-to-Case, for IGBT	$R_{\theta JC}$	0.68	°C/W
Thermal Resistance Junction-to-Case, for Diode	$R_{\theta JC}$	1.55	
Thermal Resistance Junction-to-Ambient	$R_{\theta JA}$	40	

**Table 2. ELECTRICAL CHARACTERISTICS** ( $T_C = 25^\circ\text{C}$  unless otherwise stated)

Parameter	Symbol	Test Condition	Min	Typ	Max	Unit
<b>OFF CHARACTERISTICS</b>						
Collector-to-Emitter Breakdown Voltage	$BV_{CES}$	$V_{GE} = 0\text{ V}, I_C = 1\text{ mA}$	650	-	-	V
Temperature Coefficient of Breakdown Voltage	$\Delta V_{CES} / \Delta T_J$	$V_{GE} = 0\text{ V}, I_C = 1\text{ mA}$	-	0.6	-	V/°C
Collector Cut-Off Current	$I_{CES}$	$V_{CE} = V_{CES}, V_{GE} = 0\text{ V}$	-	-	250	μA
G-E Leakage Current	$I_{GES}$	$V_{GE} = V_{GES}, V_{CE} = 0\text{ V}$	-	-	±400	nA
<b>ON CHARACTERISTICS</b>						
Gate Threshold Voltage	$V_{GE(th)}$	$V_{GE} = V_{CE}, I_C = 30\text{ mA}$	3.0	4.5	6.0	V
Collector-to-Emitter Saturation Voltage	$V_{CE(sat)}$	$I_C = 30\text{ A}, V_{GE} = 15\text{ V}, T_C = 25^\circ\text{C}$	-	1.6	2.1	V
		$I_C = 30\text{ A}, V_{GE} = 15\text{ V}, T_C = 175^\circ\text{C}$	-	1.92	-	V
<b>DYNAMIC CHARACTERISTICS</b>						
Input Capacitance	$C_{ies}$	$V_{CE} = 30\text{ V}, V_{GE} = 0\text{ V}, f = 1\text{ MHz}$	-	1871	-	pF
Output Capacitance	$C_{oes}$		-	44	-	
Reverse Transfer Capacitance	$C_{res}$		-	7	-	
<b>SWITCHING CHARACTERISTICS</b>						
Turn-On Delay Time	$t_{d(on)}$	$V_{CC} = 400\text{ V}, I_C = 30\text{ A}, R_G = 6\ \Omega,$ $V_{GE} = 15\text{ V},$ Inductive Load, $T_C = 25^\circ\text{C}$	-	14.5	-	ns
Rise Time	$t_r$		-	16	-	ns
Turn-Off Delay Time	$t_{d(off)}$		-	63.2	-	ns
Fall Time	$t_f$		-	8.3	-	ns
Turn-On Switching Loss	$E_{on}$		-	0.783	-	mJ
Turn-Off Switching Loss	$E_{off}$		-	0.160	-	mJ
Total Switching Loss	$E_{ts}$	-	0.943	-	mJ	
Turn-On Delay Time	$t_{d(on)}$	$V_{CC} = 400\text{ V}, I_C = 30\text{ A}, R_G = 6\ \Omega,$ $V_{GE} = 15\text{ V},$ Inductive Load, $T_C = 175^\circ\text{C}$	-	12.8	-	ns
Rise Time	$t_r$		-	20.8	-	ns
Turn-Off Delay Time	$t_{d(off)}$		-	67.2	-	ns
Fall Time	$t_f$		-	11.5	-	ns
Turn-On Switching Loss	$E_{on}$		-	1.01	-	mJ
Turn-Off Switching Loss	$E_{off}$		-	0.369	-	mJ
Total Switching Loss	$E_{ts}$	-	1.379	-	mJ	
Total Gate Charge	$Q_g$	$V_{CE} = 400\text{ V}, I_C = 30\text{ A},$ $V_{GE} = 15\text{ V}$	-	56	-	nC
Gate-to-Emitter Charge	$Q_{ge}$		-	11	-	nC
Gate-to-Collector Charge	$Q_{gc}$		-	14	-	nC

# AFGB30T65SQDN

**Table 2. ELECTRICAL CHARACTERISTICS** ( $T_C = 25^\circ\text{C}$  unless otherwise stated)

Parameter	Symbol	Test Condition	Min	Typ	Max	Unit
<b>DIODE CHARACTERISTICS</b>						
Diode Forward Voltage	$V_{FM}$	$I_F = 20\text{ A}$	–	1.5	2.1	V
Reverse Recovery Energy	$E_{rec}$	$I_F = 20\text{ A}$ $di_F/dt = 200\text{ A}/\mu\text{s}$ , $T_C = 25^\circ\text{C}$	–	22	–	$\mu\text{J}$
Diode Reverse Recovery Time	$t_{rr}$		–	131	–	ns
Diode Reverse Recovery Charge	$Q_{rr}$		–	348	–	nC
Reverse Recovery Energy	$E_{rec}$	$I_F = 20\text{ A}$ $di_F/dt = 200\text{ A}/\mu\text{s}$ , $T_C = 175^\circ\text{C}$	–	100	–	$\mu\text{J}$
Diode Reverse Recovery Time	$t_{rr}$		–	245	–	ns
Diode Reverse Recovery Charge	$Q_{rr}$		–	961	–	nC

Product parametric performance is indicated in the Electrical Characteristics for the listed test conditions, unless otherwise noted. Product performance may not be indicated by the Electrical Characteristics if operated under different conditions.

# AFGB30T65SQDN

## TYPICAL CHARACTERISTICS

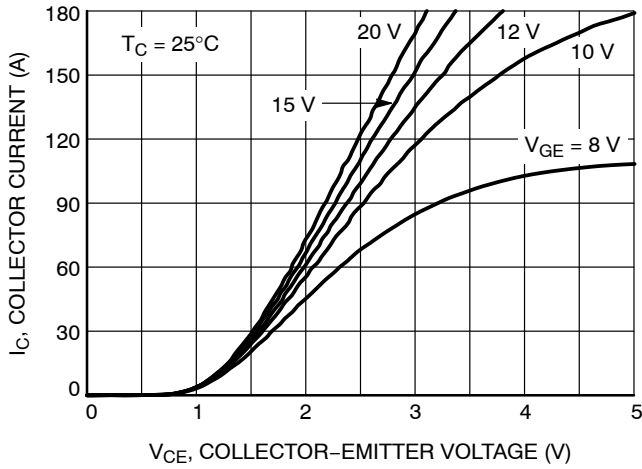

Figure 1. Typical Output Characteristics (25°C)

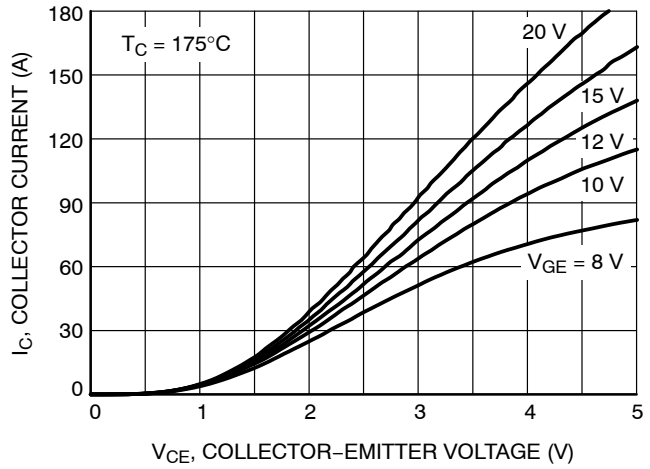

Figure 2. Typical Output Characteristics (175°C)

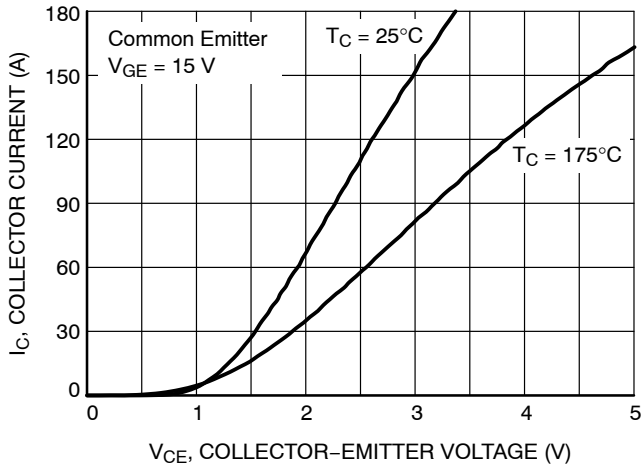

Figure 3. Typical Saturation Voltage Characteristics

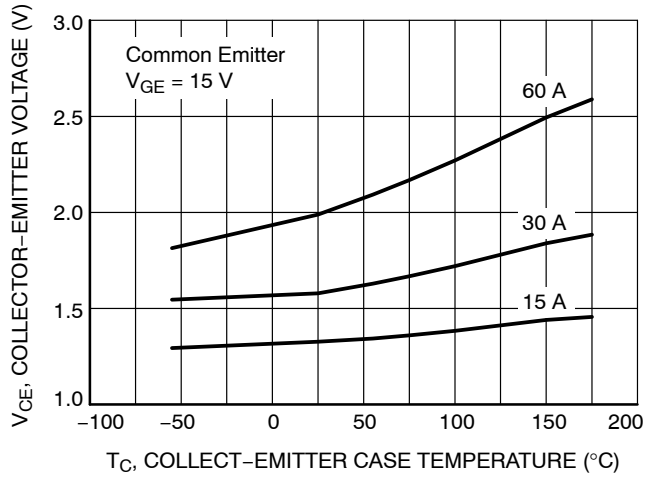

Figure 4. Saturation Voltage vs. Case Temperature at Variant Current Level

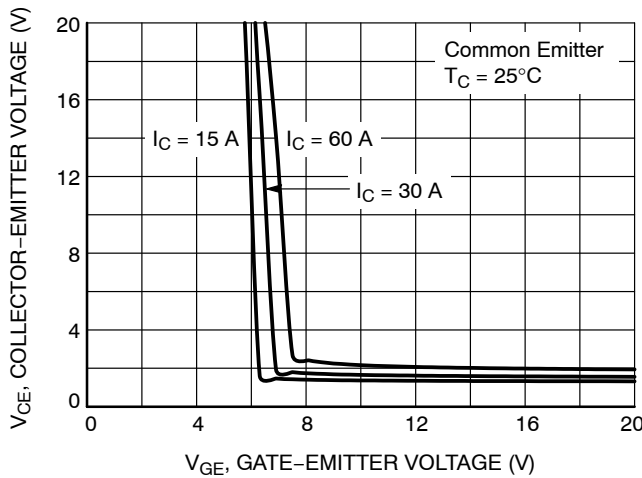

Figure 5. Saturation Voltage vs.  $V_{GE}$  (25°C)

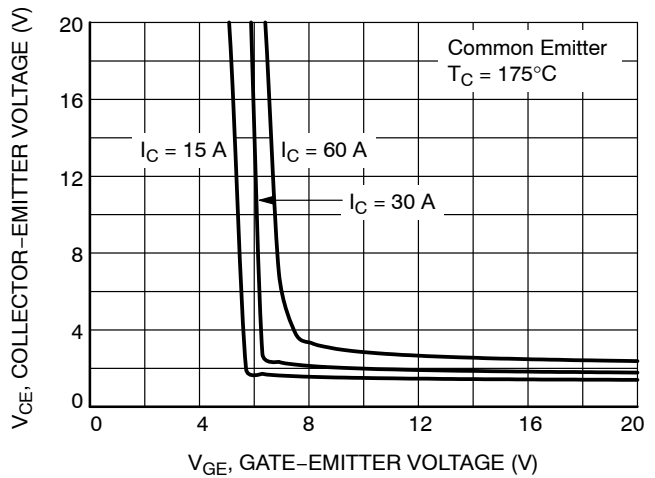

Figure 6. Saturation Voltage vs.  $V_{GE}$  (175°C)

# AFGB30T65SQDN

## TYPICAL CHARACTERISTICS

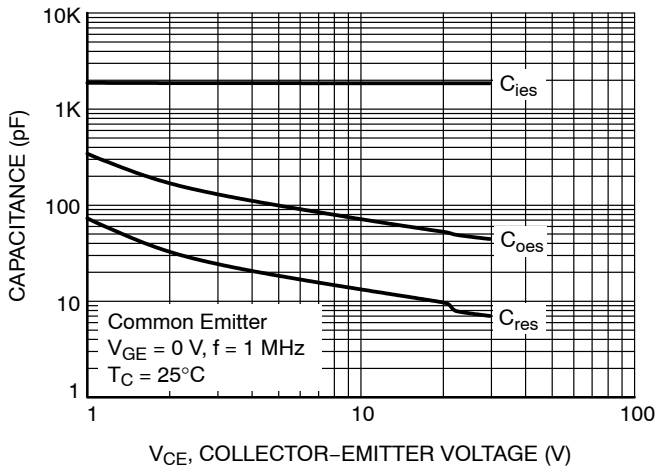

Figure 7. Capacitance Characteristics

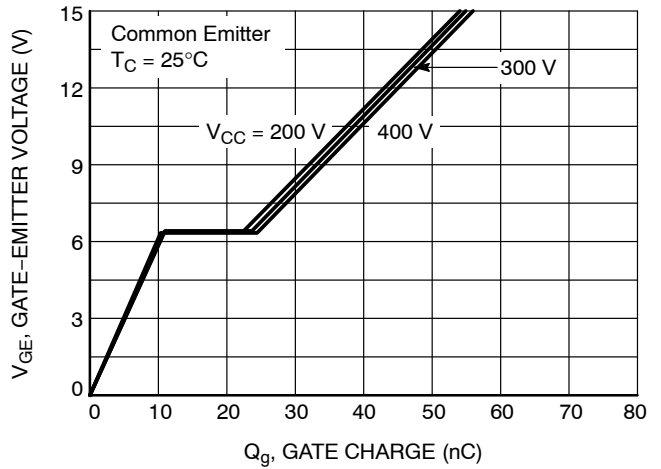

Figure 8. Gate Charge Characteristics

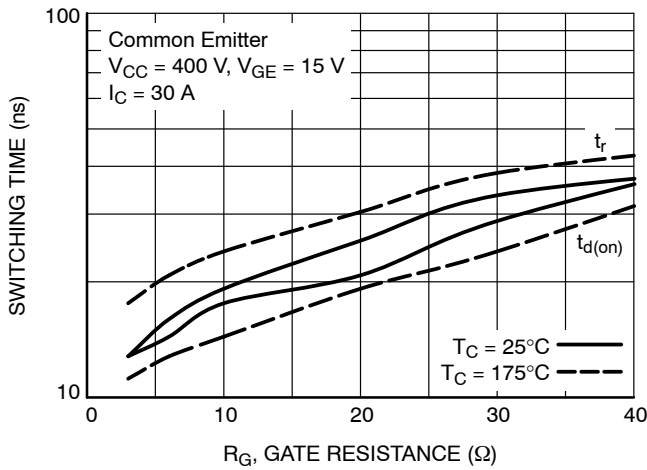

Figure 9. Turn-on Characteristics vs. Gate Resistance

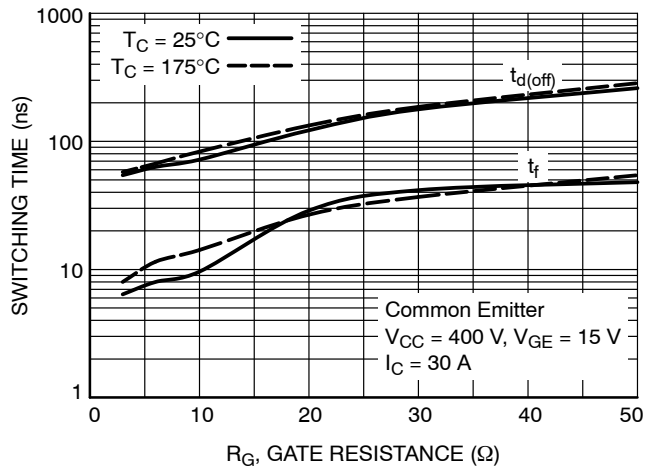

Figure 10. Turn-off Characteristics vs. Gate Resistance

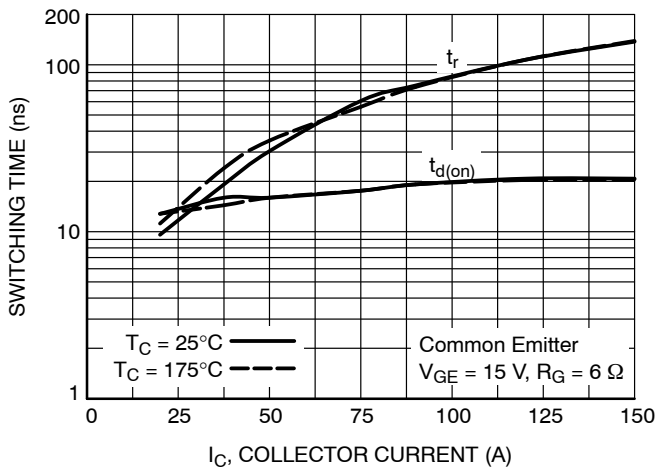

Figure 11. Turn-on Characteristics vs. Collector Current

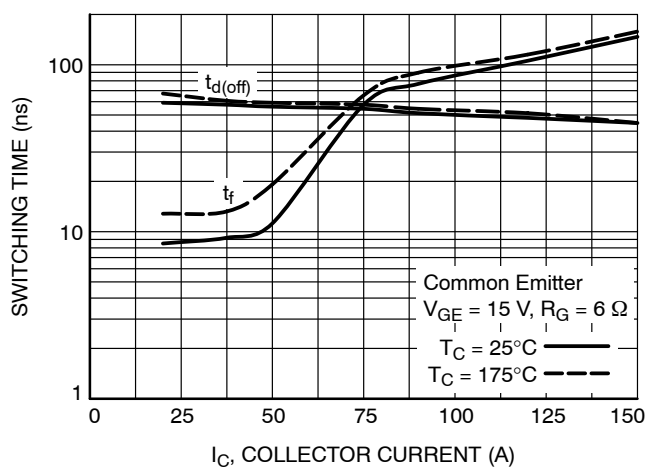

Figure 12. Turn-off Characteristics vs. Collector Current

# AFGB30T65SQDN

## TYPICAL CHARACTERISTICS

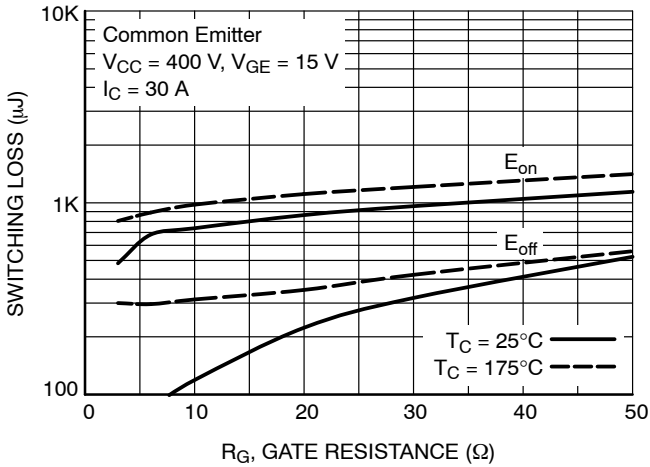

Figure 13. Switching Loss vs. Gate Resistance

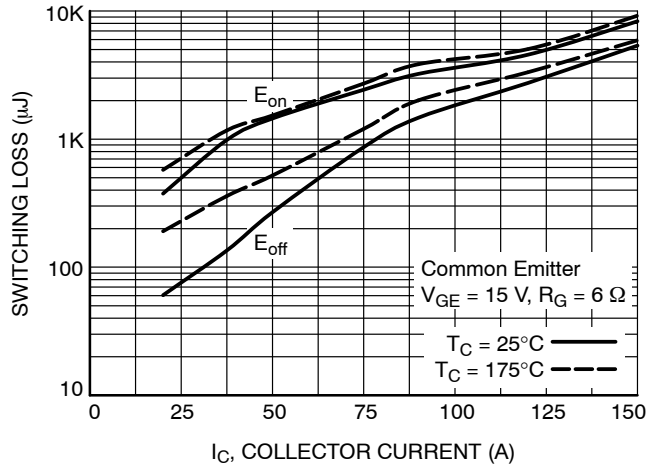

Figure 14. Switching Loss vs. Collector Current

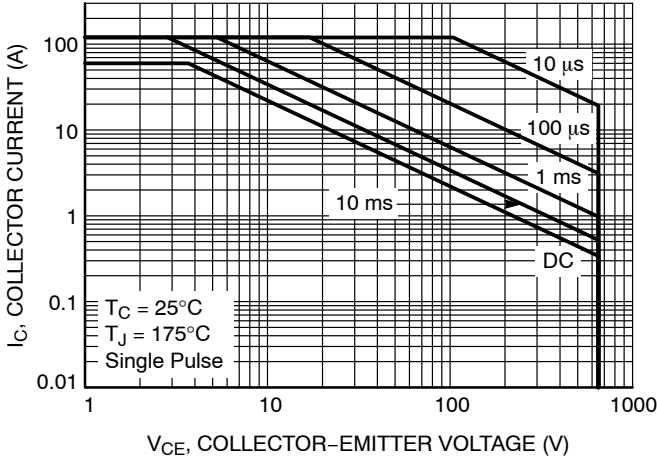

Figure 15. SOA Characteristics

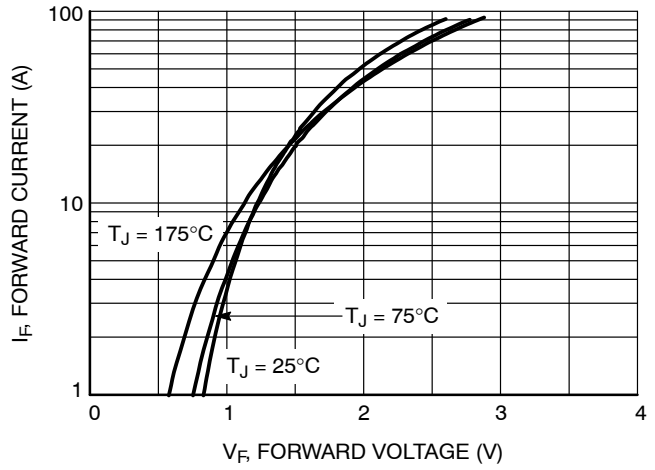

Figure 16. Forward Characteristics

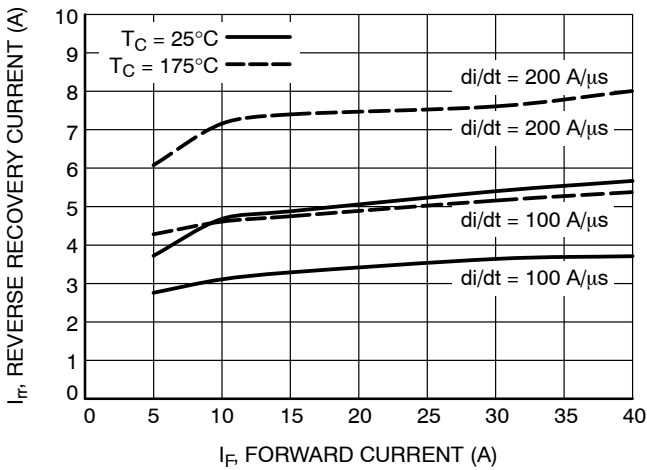

Figure 17. Reverse Recovery Current

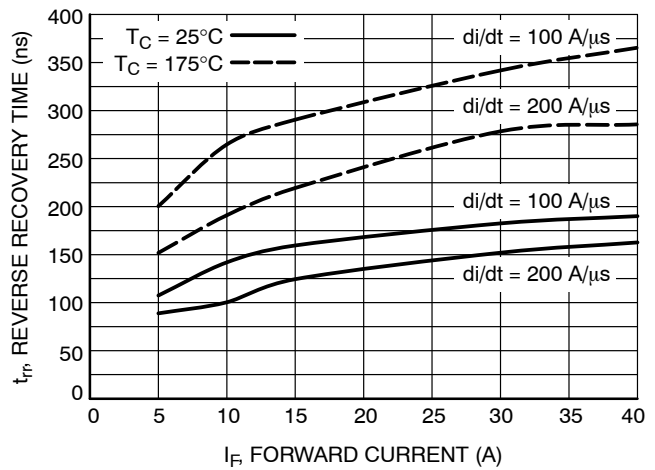

Figure 18. Reverse Recovery Time

# AFGB30T65SQDN

## TYPICAL CHARACTERISTICS

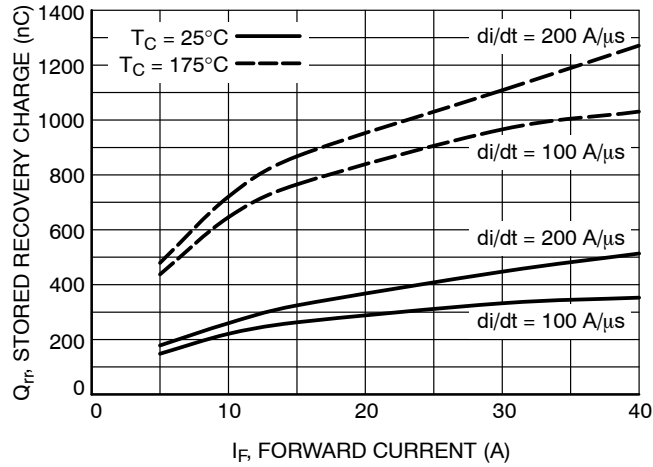

Figure 19. Stored Charge

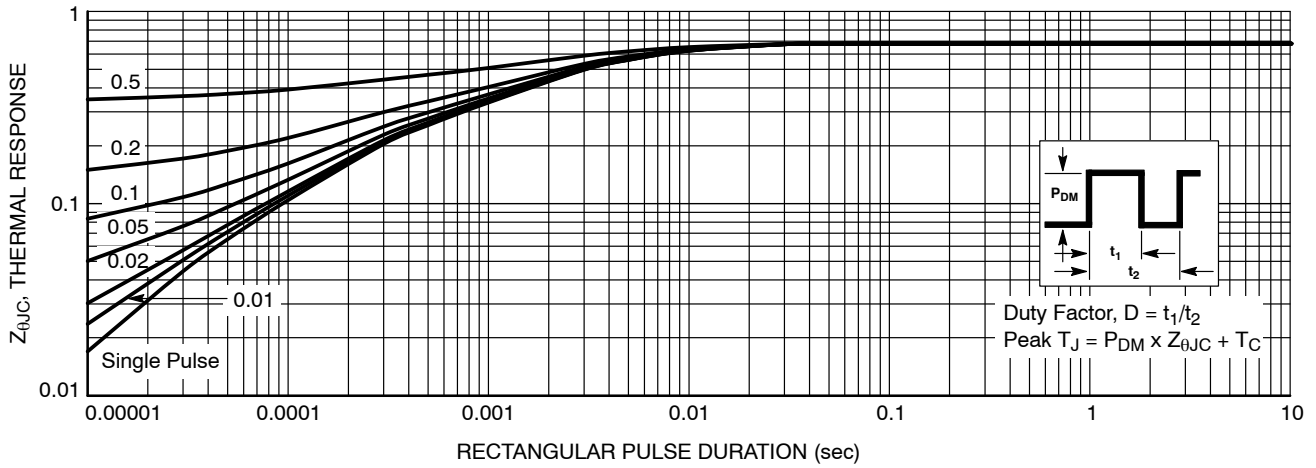

Figure 20. Transient Thermal Impedance of IGBT

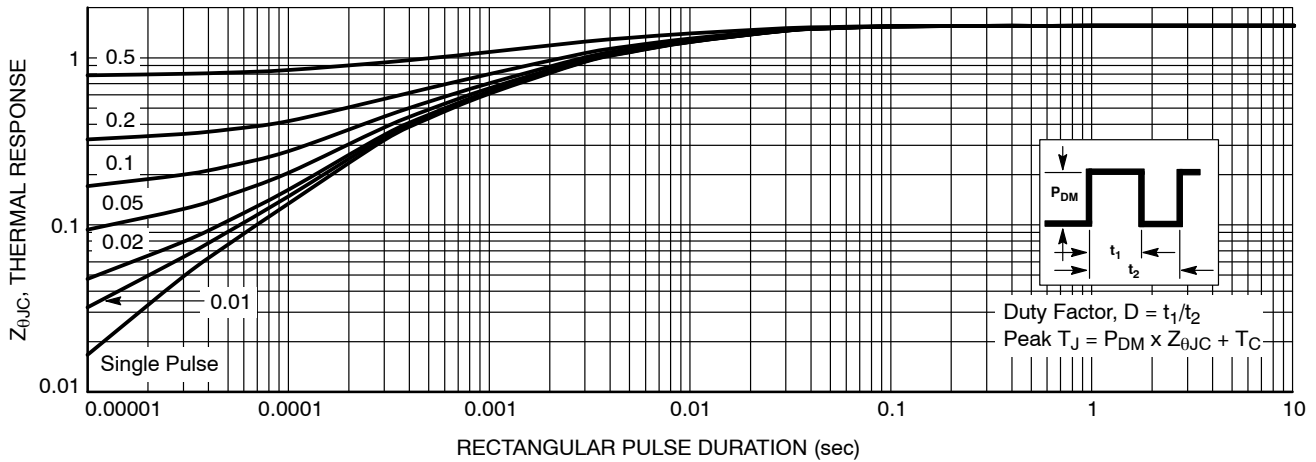

Figure 21. Transient Thermal Impedance of Diode



# MECHANICAL CASE OUTLINE

## PACKAGE DIMENSIONS

ON Semiconductor®



SCALE 1:1

### D<sup>2</sup>PAK-3 (TO-263, 3-LEAD) CASE 418AJ ISSUE E

DATE 25 OCT 2019

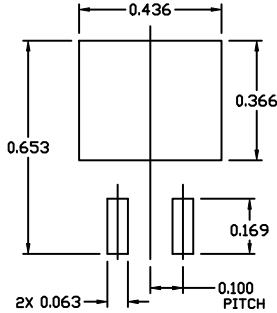

#### RECOMMENDED MOUNTING FOOTPRINT

For additional information on our Pb-Free strategy and soldering details, please download the ON Semiconductor Soldering and Mounting Techniques Reference Manual, SD-1066M/D.

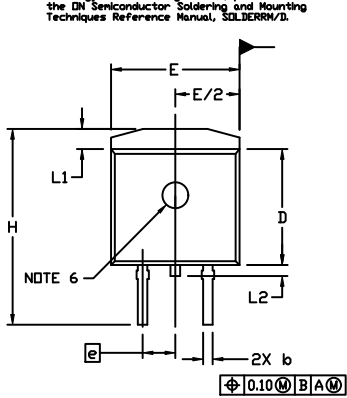

#### NOTES:

1. DIMENSIONING AND TOLERANCING PER ASME Y14.5M, 2009.
2. CONTROLLING DIMENSION: INCHES
3. CHAMFER OPTIONAL.
4. DIMENSIONS D AND E DO NOT INCLUDE MOLD FLASH. MOLD FLASH SHALL NOT EXCEED 0.005 PER SIDE. THESE DIMENSIONS ARE MEASURED AT THE OUTERMOST EXTREMES OF THE PLASTIC BODY AT DATUM H.
5. THERMAL PAD CONTOUR IS OPTIONAL WITHIN DIMENSIONS E, L1, D1, AND E1.
6. OPTIONAL MOLD FEATURE.
7. Ⓛ, Ⓜ ... OPTIONAL CONSTRUCTION FEATURE CALL OUTS.

DIM	INCHES		MILLIMETERS	
	MIN.	MAX.	MIN.	MAX.
A	0.160	0.190	4.06	4.83
A1	0.000	0.010	0.00	0.25
b	0.020	0.039	0.51	0.99
c	0.012	0.029	0.30	0.74
c2	0.045	0.065	1.14	1.65
D	0.330	0.380	8.38	9.65
D1	0.260	---	6.60	---
E	0.380	0.420	9.65	10.67
E1	0.245	---	6.22	---
e	0.100	BSC	2.54	BSC
H	0.575	0.625	14.60	15.88
L	0.070	0.110	1.78	2.79
L1	---	0.066	---	1.68
L2	---	0.070	---	1.78
L3	0.010	BSC	0.25	BSC
M	-8°	8°	-8°	8°

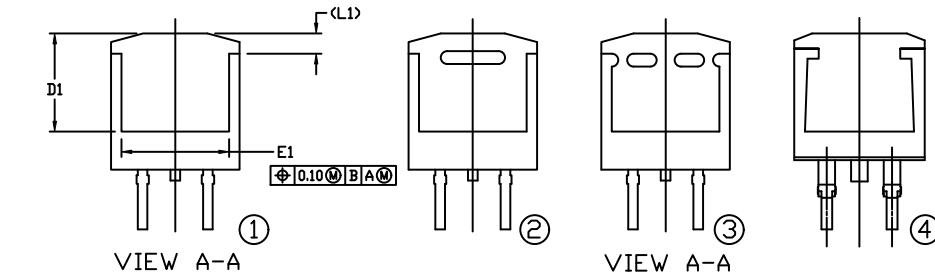
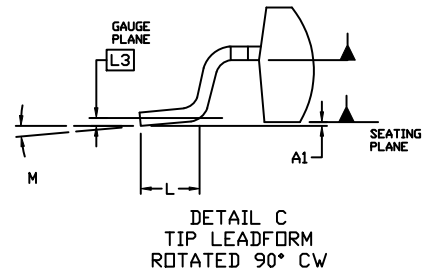
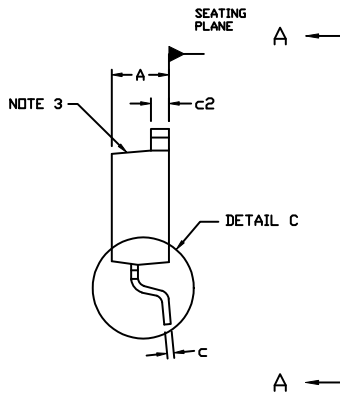

#### GENERIC MARKING DIAGRAMS\*

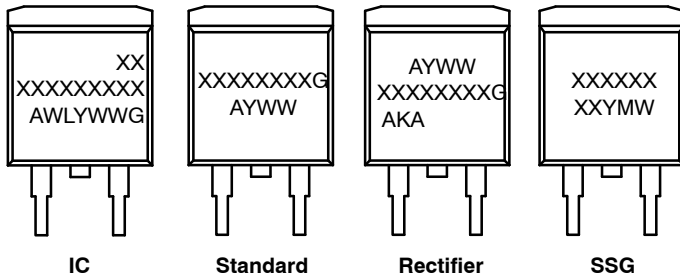

- XXXXXX = Specific Device Code
- A = Assembly Location
- WL = Wafer Lot
- Y = Year
- WW = Work Week
- W = Week Code (SSG)
- M = Month Code (SSG)
- G = Pb-Free Package
- AKA = Polarity Indicator

\*This information is generic. Please refer to device data sheet for actual part marking. Pb-Free indicator, "G" or microdot "▪", may or may not be present. Some products may not follow the Generic Marking.

DOCUMENT NUMBER:	98AON56370E	Electronic versions are uncontrolled except when accessed directly from the Document Repository. Printed versions are uncontrolled except when stamped "CONTROLLED COPY" in red.
DESCRIPTION:	D <sup>2</sup> PAK-3 (TO-263, 3-LEAD)	PAGE 1 OF 1

ON Semiconductor and ON are trademarks of Semiconductor Components Industries, LLC dba ON Semiconductor or its subsidiaries in the United States and/or other countries. ON Semiconductor reserves the right to make changes without further notice to any products herein. ON Semiconductor makes no warranty, representation or guarantee regarding the suitability of its products for any particular purpose, nor does ON Semiconductor assume any liability arising out of the application or use of any product or circuit, and specifically disclaims any and all liability, including without limitation special, consequential or incidental damages. ON Semiconductor does not convey any license under its patent rights nor the rights of others.

ON Semiconductor and  are trademarks of Semiconductor Components Industries, LLC dba ON Semiconductor or its subsidiaries in the United States and/or other countries. ON Semiconductor owns the rights to a number of patents, trademarks, copyrights, trade secrets, and other intellectual property. A listing of ON Semiconductor's product/patent coverage may be accessed at [www.onsemi.com/site/pdf/Patent-Marking.pdf](http://www.onsemi.com/site/pdf/Patent-Marking.pdf). ON Semiconductor reserves the right to make changes without further notice to any products herein. ON Semiconductor makes no warranty, representation or guarantee regarding the suitability of its products for any particular purpose, nor does ON Semiconductor assume any liability arising out of the application or use of any product or circuit, and specifically disclaims any and all liability, including without limitation special, consequential or incidental damages. Buyer is responsible for its products and applications using ON Semiconductor products, including compliance with all laws, regulations and safety requirements or standards, regardless of any support or applications information provided by ON Semiconductor. "Typical" parameters which may be provided in ON Semiconductor data sheets and/or specifications can and do vary in different applications and actual performance may vary over time. All operating parameters, including "Typicals" must be validated for each customer application by customer's technical experts. ON Semiconductor does not convey any license under its patent rights nor the rights of others. ON Semiconductor products are not designed, intended, or authorized for use as a critical component in life support systems or any FDA Class 3 medical devices or medical devices with a same or similar classification in a foreign jurisdiction or any devices intended for implantation in the human body. Should Buyer purchase or use ON Semiconductor products for any such unintended or unauthorized application, Buyer shall indemnify and hold ON Semiconductor and its officers, employees, subsidiaries, affiliates, and distributors harmless against all claims, costs, damages, and expenses, and reasonable attorney fees arising out of, directly or indirectly, any claim of personal injury or death associated with such unintended or unauthorized use, even if such claim alleges that ON Semiconductor was negligent regarding the design or manufacture of the part. ON Semiconductor is an Equal Opportunity/Affirmative Action Employer. This literature is subject to all applicable copyright laws and is not for resale in any manner.

## PUBLICATION ORDERING INFORMATION

### LITERATURE FULFILLMENT:

Email Requests to: [orderlit@onsemi.com](mailto:orderlit@onsemi.com)

ON Semiconductor Website: [www.onsemi.com](http://www.onsemi.com)

### TECHNICAL SUPPORT

North American Technical Support:  
Voice Mail: 1 800-282-9855 Toll Free USA/Canada  
Phone: 011 421 33 790 2910

Europe, Middle East and Africa Technical Support:

Phone: 00421 33 790 2910

For additional information, please contact your local Sales Representative