

General Description

The MAX14921 evaluation kit (EV kit) demonstrates a high-accuracy 16-cell battery-management reference design. The MAX14921 is a high-accuracy 16-cell measurement analog front-end (AFE) in an 80-pin TQFP surface-mount package. The EV kit features an ADC and reference, and an isolated interface to a PC through a USB port to easily measure all cell voltages. Cell stacks up to 16 cells or 65V can be monitored, whichever is lower. The EV kit circuit demonstrates all the features of the device through a GUI application on a Windows®-based PC.

MAX14921 EV Kit Photo



Benefits and Features

- 16-Cell/65V (max) Stack Operating Voltage Range
- Built-In Isolated USB Interface to a Windows-Based PC
- Plug-and-Play GUI Demonstrates All the Major Features of the MAX14921
- μ C Firmware in C Available Upon Request
- Screw Terminal Battery Connector
- Proven PCB Layout
- Fully Assembled and Tested

Block Diagram appears at end of data sheet.

Ordering Information appears at end of data sheet.

Component List

DESIGNATION	QTY	DESCRIPTION
C1–C16	16	1.2 μ F \pm 10%, 16V X7R ceramic capacitors (0805) KEMET C0805C125K4RACTU
C17	1	10 μ F \pm 10%, 10V X5R ceramic capacitor (0805) KEMET C0805C106K8PAC
C18–C22, C30, C107, C126–C129, C135, C138	13	0.1 μ F \pm 10%, 16V X7R ceramic capacitors (0603) Murata GRM188R71C104K
C23, C31, C108–C111, C115, C130, C131, C136	10	1 μ F \pm 10%, 16V X7R ceramic capacitors (0603) Murata GRM188R71C105K
C24	1	0.1 μ F \pm 10%, 100V X7R ceramic capacitor (0603) Murata GRM188R72A104KA35D
C25, C29	2	100pF \pm 10%, 16V X7R ceramic capacitors (0603) AVX 0603YC101KAT2A
C27, C28	2	0.01 μ F \pm 5%, 16V X7R ceramic capacitors (0603) AVX 0603YC103JAT2A

Windows is a registered trademark and a registered service mark of Microsoft Corporation.

Component List (continued)

DESIGNATION	QTY	DESCRIPTION
C101, C103, C104, C132, C137	5	4.7 μ F +80%/-20%, 10V Y5V ceramic capacitors (0603) Murata GRM188F51A475ZE20D
C105, C106	2	18pF \pm 5%, 50V NP0 ceramic capacitors (0603) Murata GRM1885C1H180JA01D
C112–C114, C116–C119	0	Not installed, ceramic capacitors (0603)
C133	1	4.7 μ F \pm 10%, 16V X7R ceramic capacitor (0603) Murata GRM21BR71C475KA73L
C134	1	0.47 μ F \pm 10%, 16V X5R ceramic capacitor (0603) TDK C1608X5R1C474K
D1, D101, D102	3	100V, 200mW Schottky diodes (SOD123) Diodes Inc. BAT46W-7-F
D2	1	68V, 500mW zener diode (SOD123) ON Semi MMSZ5266BT1G
D3	0	Not installed, diode (SOD123)
L101	1	600 Ω , 200mA ferrite chip (0805) Murata BLM21AG601SN1
LED101, LED103	2	Red LEDs Lite-On LTST-C150CKT
LED102	1	Green LED Lite-On LTST-C150GKT
P2	1	24-pin power connector Weidmuller 1841850000
P101	0	Not installed, 72-pin dual-row connector header, 0.1in centers Sullins PEC36DAAN
P102, P105	2	USB micro-B connectors Hirose ZX62-B-5PA(11)
P103	0	Not installed, USB type-A connector Mill-Max 896-43-004-00-000000
P104	0	Not installed, 9-pin header, 0.1in centers Samtec TSW-150-07-T-S
P106–P113	0	Not installed, test points

DESIGNATION	QTY	DESCRIPTION
Q1–Q16	16	30V n-channel FETs (SOT23) ON Semi NTR4170NT1G or NXP 2N7002BK,215
Q101–Q103	3	40V npn bipolar transistors (SOT23) ON Semi MMBT3904LT3G
R1, R40–R54	16	100 Ω \pm 5% resistors (0603)
R2, R58	2	220 Ω \pm 1% resistors (0603)
R3, R4, R101, R108, R131, R133, R135, R140	8	10k Ω \pm 1% resistors (0603)
R7–R22	16	3.3k Ω \pm 5% resistors (0603)
R23–R38	16	33 Ω \pm 5%, 1W resistors (2512)
R39	1	100 Ω \pm 5% resistor (0805)
R56, R57	2	1k Ω \pm 1% resistors (0603)
R59, R60, R126, R129	4	10k Ω \pm 1% resistors (0603)
R61, R106, R107, R109, R110, R116–R128	0	Not installed, resistors (0603)
R102, R103	2	137 Ω \pm 1% resistors (0805)
R111	1	332 Ω \pm 1% resistor (0603)
R112	1	39.2k Ω \pm 1% resistor (0603)
R113	1	102k Ω \pm 1% resistor (0603)
R114	1	3.92k Ω \pm 1% resistor (0603)
R115	1	1.5k Ω \pm 1% resistor (0603)
R130	1	1k Ω \pm 5% resistor (0805)
R132	1	6.04k Ω \pm 1% resistor (0603)
R134	1	3.32k Ω \pm 1% resistor (0603)
R136, R137	2	301k Ω \pm 1% resistors (0603)
R138, R139	2	20k Ω \pm 1% resistors (0603)
R141	1	28k Ω \pm 1% resistor (0603)
S101, S102	2	Momentary pushbutton switches OMRON B3FS-1000P
S103–S106	0	Not installed, momentary pushbutton switches
T101	1	1:1:2.6:2.6 1.5kV _{RMS} isolation module HALO Electronics TGM-H281NF

Component List (continued)

DESIGNATION	QTY	DESCRIPTION
U1	1	High-accuracy 16-cell measurement AFEs (80 TQFP) Maxim MAX14921ECS+
U2	1	4.096V voltage reference (8 SO) Maxim MAX6126AASA41+
U3	1	16-bit analog-to-digital converter (10 MSOP) Maxim MAX11163EUB+
U4	1	Op amp (5 SC70) Maxim MAX9620AXK+
U101	1	ARM-based 32-bit microcontroller (64 LQFP) STMicro STM32F101RET6
U102	0	Not installed, quad 6Mbps level translator (12 TQFN) Maxim MAX3395EETC+
U103, U105	0	Not installed, 1.5A current-limit switches (8 TDFN-EP*) Maxim MAX14523AATA+
U104	0	Not installed, USB peripheral/host controller with SPI interface (32 TQFP) Maxim MAX3421EETJ+

DESIGNATION	QTY	DESCRIPTION
U107, U108	2	6-channel 600V _{RMS} digital isolators (16 SO) Maxim MAX14850ASE+
U109, U110	2	12V adjustable LDOs (6 TDFN-EP*) Maxim MAX8880ETT+
U111	1	3W primary-side transformer H-bridge driver (8 SO) Maxim MAX256ASA+
U112	1	USB to serial UART (28 SSOP) FTDI FT232RL-REEL
U113, U114	2	1.5A current-limit switches (8 TDFN-EP*) Maxim MAX14523AATA+
Y101	1	8MHz, 18pF crystal (HC49/US) Citizen HCM49-8.000MABJ-UT
Y102	0	Not installed, 12MHz 18pF crystal (4 SMD) CTS 406C35D12M00000
—	1	PCB: MAX14921 ADVANCED EVAL PCB

*EP = Exposed pad.

Component Suppliers

SUPPLIER	PHONE	WEBSITE
AVX North America	864-967-2150	www.avx.com
Citizen America Corp.	310-781-1460	www.citizencrystal.com
Diodes Incorporated	805-446-4800	www.diodes.com
HALO Electronics, Inc.	650-903-3800	www.haloelectronics.com
Hirose Electric Co., Ltd.	81-3-3491-9741	www.hirose.com
KEMET Corp.	864-963-6300	www.kemet.com
Lite-On, Inc.	408-946-4873	www.us.liteon.com
Murata Americas	800-241-6574	www.murataamericas.com
OMRON Corp.	—	www.omron.com
ON Semiconductor	602-244-6600	www.onsemi.com
Samtec, Inc.	800-726-8329	www.samtec.com
STMicroelectronics	408-452-8585	www.us.st.com
Sullins Electronics Corp.	760-744-0125	www.sullinselectronics.com
TDK Corp.	847-803-6100	www.component.tdk.com

Note: Indicate that you are using the MAX14921 when contacting these component suppliers.

Quick Start

Required Equipment

- MAX14921 EV kit
- The two files: The “MAX14921 Eval PCB” application (MAX14921 EVAL PCB.EXE) and the DLL “msvcr100.dll”
- Visit www.maximintegrated.com/evkitsoftware to download the latest version of the EV kit software
- PC running Windows, with 1 spare USB port
- USB to micro-USB cable
- Stack of batteries to test

Procedure

Step 1: Attach Battery

Note: Total battery stack voltage cannot exceed 65V. You risk failure of the device if you exceed this voltage.

Look at the detachable battery connector, and see how it mates to the EV kit, see Figure 1. Connect the bottom cell of the battery stack (the lowest voltage) to the VC0 screw terminal and to the adjacent GND screw terminal. Be sure to use two separate wires for these connections. Connect the top of that cell (also connected to the bottom of the second cell) to the VC1 screw terminal.

Continue in this fashion until you connect the top of the 16th cell of the battery stack (the highest voltage) to the VC16 screw terminal and the POWER screw terminal. Be sure to use two separate wires for these connections.

What if you have less than 16 cells in your battery stack? The device can handle 3–16 cells. For example, you have only 12 cells, in that case, connect the top of the 12th cell (the highest voltage) to all VC12–VC16 and POWER screw terminals.

Why do I need to connect the top and the bottom of the battery stack twice? The device takes just a small amount of current from the battery stack to operate. This tiny power consumption is routed through the POWER and GND terminals. Providing a separate measurement trace to the top and the bottom of the battery stack

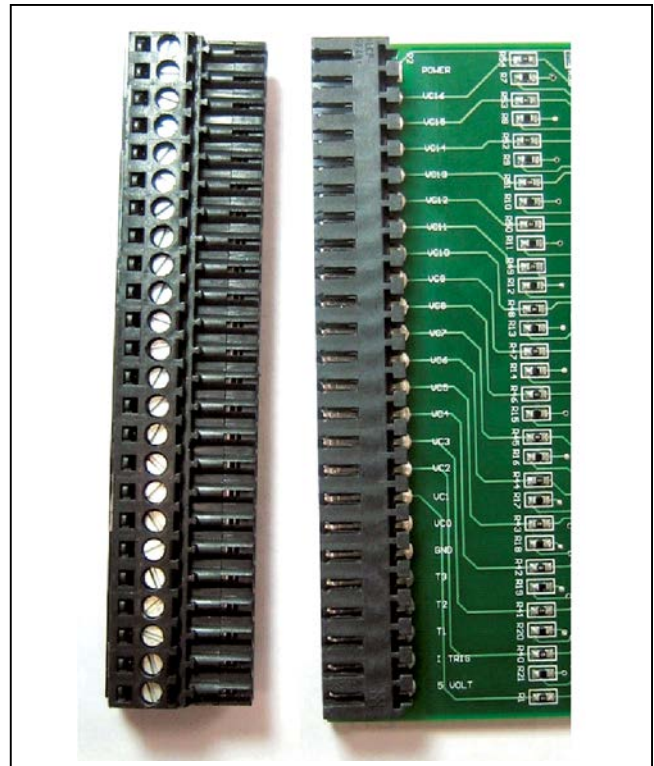

Figure 1. Detachable Battery Connector

ensures that even this tiny current does not affect cell measurement accuracy.

Plug the terminal strip portion of the connector into the mating plug on the EV kit. See Figure 1.

Step 2: Run the Application

Visit www.maximintegrated.com/evkitsoftware to download the latest version of the EV kit software, MAX14921 EVKIT Software.ZIP. Save the EV kit software to a temporary folder. Open the .ZIP file and extract the .EXE file to your preferred location. The .EXE file is the actual EV kit GUI and not an install program. You can store the .EXE file wherever you like and then uninstall it later by simply deleting the .EXE file.

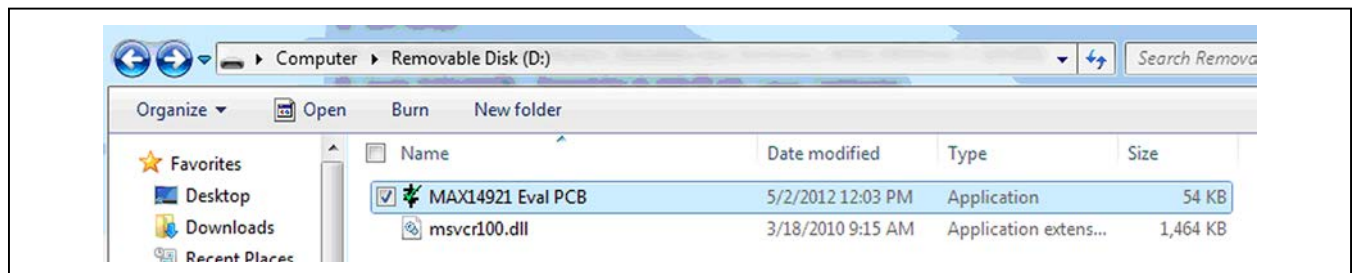

Figure 2. Files Required to Run the Application

Ensure that both files the application (“MAX14921 Eval PCB” and the DLL “msvcr100.dll”) are in the same folder. Navigate to the folder with the files and select the “MAX14921 Eval PCB” application. Double-click on it to run the application. See Figure 2.

If I have the files on a separate drive, do I need to move these files to my PC? If you have the files on a USB memory device, there is no need to move them. As long as the two files remain in the same folder, the application runs anywhere, including from a USB memory device.

Does the application install a driver on my PC? No, it does not. The application needs no drivers other than those built into Windows.

Once the application is running, you should see a window similar to the one in Figure 3. Most of the data items are blank and are automatically filled in when the application detects an EV kit attached to any USB port on the computer.

Step 3: Attach the EV Kit to the PC

Use the USB cable to attach the EV kit to the PC. The correct USB connector on the EV kit is labeled P102, and is near the top left of the PCB, under S101, RESET.

LED103, to the left of the isolation transformer glows red when the EV kit is properly powered (see Figure 4). Also, LED102, towards the middle of the PCB, blinks green when the microprocessor is running the firmware.

Once you have correctly attached the EV kit to the PC, the application automatically starts reporting cell voltage data.

Detailed Description of Hardware

The MAX14921 EV kit is a fully assembled and tested circuit board demonstrating the capabilities of the MAX14921 high-accuracy 16-cell battery management AFE IC in an 80-pin surface-mount TQFP package. This EV kit works with a PC-based GUI demonstrating all the major features of the device. The EV kit also features a MAX6126 precision voltage reference and a MAX11163 16-bit, 500ksps serial ADC. The MAX14921 and the analog portion of the ADC are powered by the battery cell stack. All other EV kit circuits are powered from the USB interface.

Ensure that the total cell stack voltage does not exceed 65V. Reduce the number of cells in the stack, if needed, to keep to 65V or lower.

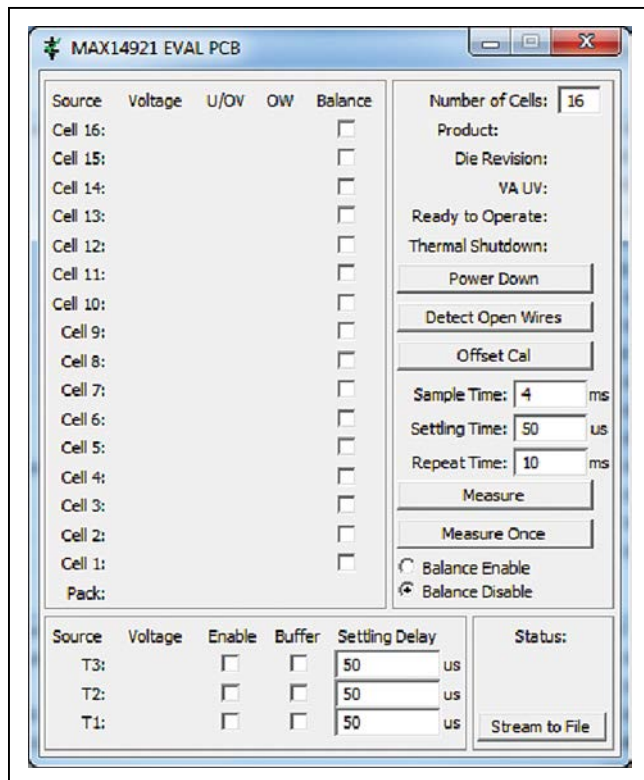

Figure 3. MAX14921 EV Kit GUI

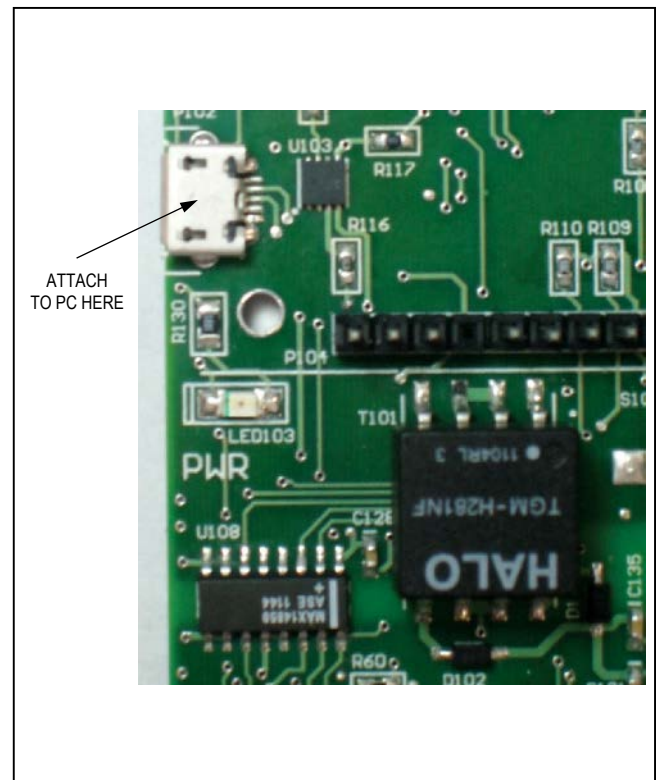

Figure 4. MAX14921 EV Kit Attachment

Analog Cell Voltage Acquisition

The heart of the EV kit is the analog signal path. The MAX14921 (U1) operates in two major phases. In the first phase, cell voltages present at the cell stack connector (P2) are acquired onto the sampling capacitors C1–C16 through 100 Ω series resistors R1 and R40–R54. These resistors limit the current during fault conditions. The default GUI sampling time of 4ms is optimized to work with these resistors and capacitors. All cell voltages are captured simultaneously.

In the second phase, captured cell voltages are level shifted down and presented to the ADC (U3) for conversion. A small circuit (R2 and C25) filters the signal between the MAX14921 and the MAX11163 ADC. To improve accuracy, an external voltage reference, MAX6126 (U2), is used to provide a stable reference to the ADC.

Auxiliary Inputs (T1–T3)

The MAX14921 also includes three general-purpose analog inputs, ranging from 0 to 5V that can be multiplexed to the ADC for conversion. Measuring temperature through inexpensive thermistors is one common use for these extra inputs. Inputs T2 and T3 on the EV kit are preset to accept a 10k Ω thermistor. The MAX9620 op amp (U4) buffers the reference voltage to 10k Ω pullup resistors (R59 and R60), while filtering is done with R56, R57, C27, and C28.

Input T1 is uncommitted. The pullup resistor (R61) for this input is not installed, and different filter components (R58 and C29) are used, optimized for faster input signals.

Cell Balancing

The EV kit includes transistors Q1–Q16 and 33 Ω power resistors for cell-balancing applications. These transistors can be enabled or disabled, using the SPI interface, in any combination at any time for passive cell-balancing purposes.

Power and Isolation

The EV kit accepts power from either USB connector, P102 or P105. To use the supplied GUI, connect to P102. P105 is used only when reprogramming microprocessor U101. Because a different protocol is used for reprogramming, the GUI does not recognize the EV kit if the USB cable is plugged in to P105. Two

MAX14523A power switches (U113 and U114) automatically power the EV kit from either USB connector. A MAX8880 linear regulator (U109) provides a clean 3.3V supply for the microprocessor (U101) and related circuitry. The microprocessor uses the Q101 and Q102 circuit to switch in or out a 1.5k Ω pullup resistor on the USB DP line, to implement USB suspend mode.

To avoid any damage to the PC in the case of accidental miswiring, the cell voltage acquisition circuitry is electrically isolated from the microprocessor circuitry and USB interface. Two MAX14850 digital isolators (U107, U108) provide this isolation for the SPI and other digital signals and a MAX256 transformer driver (U111), along with transformer T101 provide an isolated supply to a MAX8880 linear regulator (U110). The MAX8880 provides a clean 5V supply for all circuits in the analog capture path, with the exception of the internal supply of the MAX14921 and the analog supply of the MAX11163 ADC, which power from the MAX14921's internal 5V regulator.

Detailed Description of Software

The Windows-based graphical-user interface (GUI) application is simple to use and demonstrates all the important features of the device. The application automatically detects the presence of an EV kit. If the application is run before any EV kit is attached, the fields appear mostly blank, as seen in Figure 3. Once an EV kit is detected, fields are automatically filled in.

Status Section

Figure 5 shows the “Status” window, located at the bottom-right corner of the application window. It indicates the status of the EV kit connection to the PC.

The text in the window indicates whether the application sees an EV kit or not. It indicates either “EVK Attached,” or “EVK Detached.”

The third line details the real-time instructions to the EV kit from the application. Table 1 includes a detailed explanation for each label.

Control Section

Much of the control and status information for the EV kit is available in the top-right section of the application. Figure 6 and Table 2 detail the available controls and indicators.

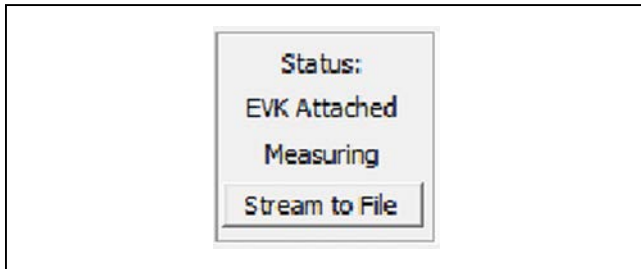

Figure 5. Status Section

Table 1. EV Kit Status Labels

LABEL	DESCRIPTION
Idling	The application has made one measurement, and continues measuring once the user has clicked either the “Measure” or the “Measure Once” button.
Measuring	The application is capturing data continuously and presenting it in the application window.
Offset Cal	The device is performing an offset calibration, as detailed in the MAX14920/MAX14921 IC data sheet.
Open Chk	The device is performing an opens check, as detailed in the MAX14920/MAX14921 IC data sheet.
Streaming	The application is capturing data at speed from the device, and is writing it to a disc file.
Waiting	The application is waiting for an EV kit to be attached to the PC through a USB port.

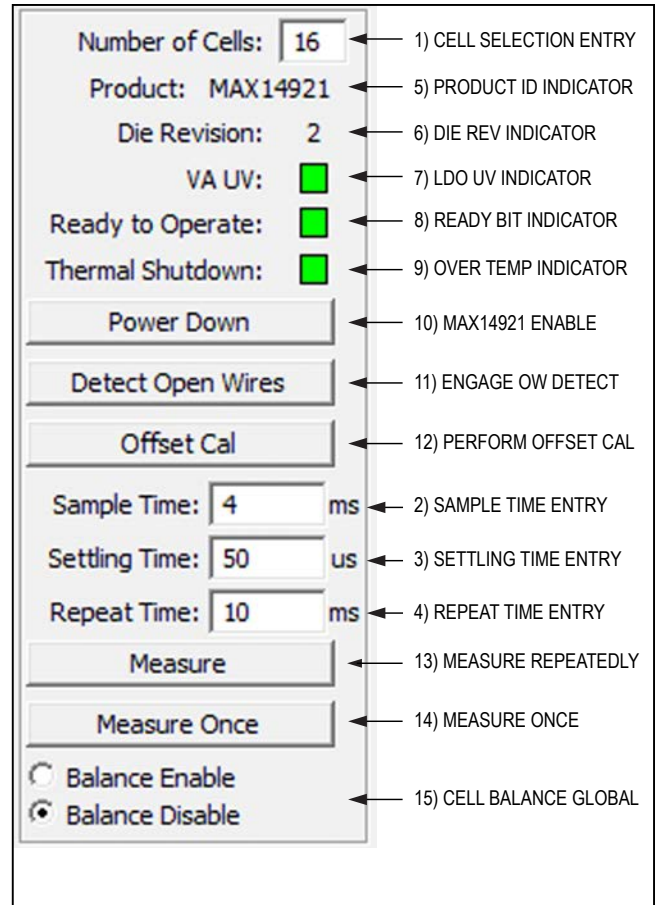

Figure 6. Control Section

Table 2. EV Kit Control Section Details (Figure 6)

ITEM	LABEL	READ/WRITE	DESCRIPTION
1	Number of Cells	Write	Enter the number of cells in the battery stack here, from 3–16 cells. This affects how many cell voltages display in the application window, as well as how many cell voltages are recorded when streaming data to a file.
2	Sample Time	Write	Sets the sample time, from 1ms to 1,000ms. This refers to the t_{SAMPLE} specification in the MAX14920/MAX14921 IC data sheet. This is the length of time that the device stays in sample phase. Setting this too low affects how accurately the cell voltages are measured. Setting it too high limits how often the cell voltages can be read. Refer to Figure 5 in the MAX14920/MAX14921 IC data sheet for more details. The default value of 4ms is optimized to work with the 1.2µF sampling capacitors and the 100Ω series resistors.
3	Settling Time	Write	Sets the delay from when the device provides a cell voltage sample to when the ADC starts conversion, from 1µs to 10,000µs. This refers to the t_{SET} specification in Figure 5 in the MAX14920/MAX14921 IC data sheet. Leave at the default of 50µs.

Table 2. EV Kit Control Section Details (Figure 6) (continued)

ITEM	LABEL	READ/WRITE	DESCRIPTION
4	Repeat Time	Write	Sets the delay between acquisitions of a set of cell voltages. For example, at the default 10ms, the device samples cell voltages 100 times per second. This entry is ignored by the application when it updates the cell voltages directly on the window. However, when streaming data to a file, this parameter sets how often a new data set is written to the file. The repeat time must be at least 1ms greater than the sample time. If not, the repeat time is about 1ms greater than the sample time.
5	Product	Read	This value is obtained from the device when the EV kit is attached to the PC.
6	Die Revision	Read	This value is obtained from the device when the EV kit is attached to the PC.
7	VA UV	Read	This status indicator is updated regularly once the EV kit is attached to the PC. A red indicator means that the internal 5V LDO is unable to provide the correct voltage to the device or to the attached external circuitry.
8	Ready to Operate	Read	This status bit is updated regularly from the device when the EV kit is attached to the PC. A red indicator means that there is something wrong with the device.
9	Thermal Shutdown	Read	This status bit is updated continuously from the device when the EV kit is attached to the PC. A red indicator means that the device is too hot.
10	Power Down	Action	Click this control button to toggle the EN pin on the device and enable or disable the IC.
11	Detect Open Wires	Action	Click this control button to implement open-wire detection as detailed in the <i>First Method of Open-Wire Detection</i> section in the MAX14920/MAX14921 IC data sheet. This detection is not continuous and happens once each time this control is pushed. It updates the open-wire (OW) indicators in the cell voltage readout section of the application window. Indicators are dimmed green or red when this information is considered stale.
12	Offset Cal	Action	Click this control button to implement the offset calibration feature, as detailed in the <i>Buffer Amplifier Offset Calibration</i> section in the MAX14920/MAX14921 IC data sheet. The output buffer offset is minimized once calibration is complete.
13	Measure	Action	Click this control button to enable continuous reading of the cell voltages, the cell U/OV bits, and the T1–T3 voltages. The application updates 6 to 7 times per second unless the sample time is set too high.
14	Measure Once	Action	Click this control button to disable continuous reading. Only one set of data is measured and presented in the application window when this button is pushed.
15	Balance Enable/Disable	Selection	This global control either disables or enables cell balancing for all cells whose balance checkboxes are checked. Cell balancing can be individually enabled with the balance checkboxes.

Cell Readout Section

The top-left section is where cell voltages are reported. Overvoltage, undervoltage, and open-wire detection are also indicated here. Cell balancing for individual cells can be enabled/disabled in this section as well. (Figure 7)

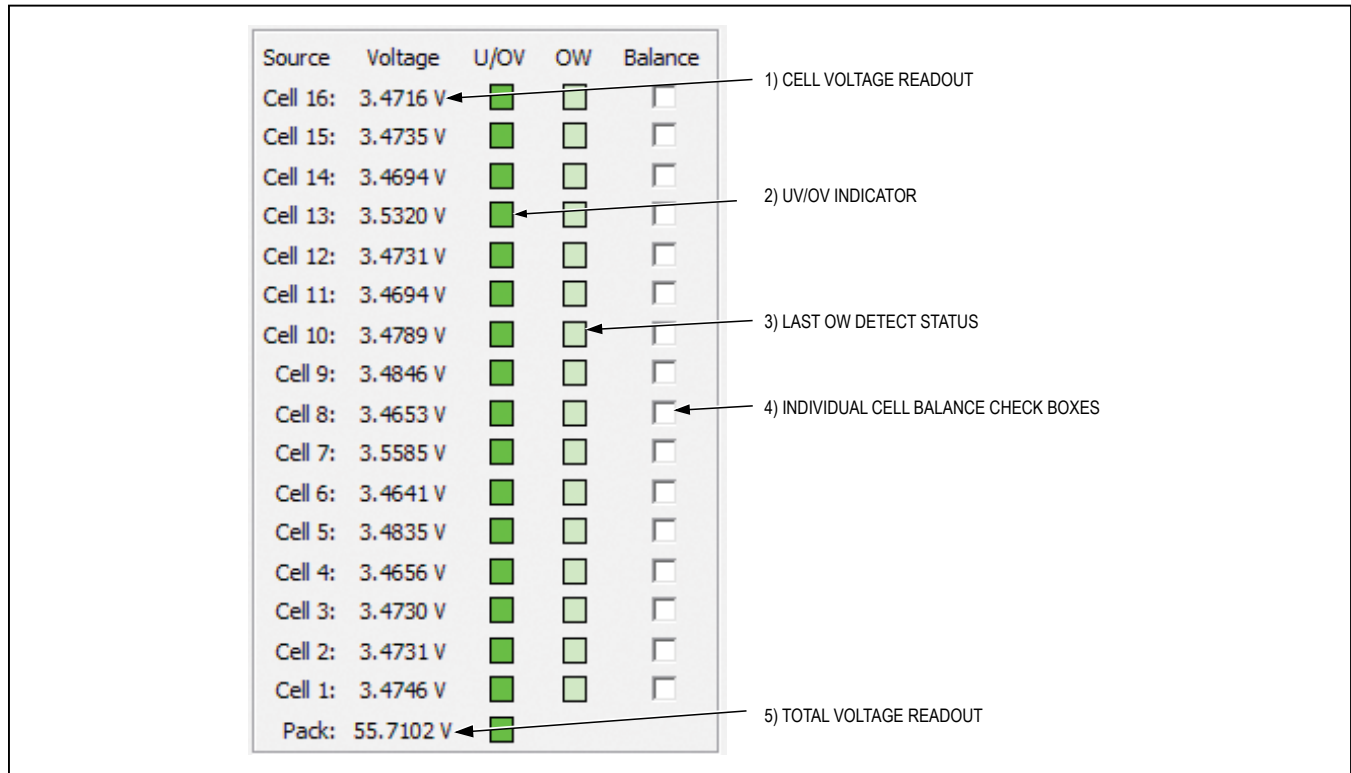

Figure 7. Cell Readout Section

Table 3. EV Kit Cell Readout Section Details (Figure 7)

ITEM	LABEL	READ/WRITE	DESCRIPTION
1	Voltage	Read	These are the cell voltages. Cell voltages are reported individually with 0.1mV resolution.
2	U/OV	Read	These indicators are updated each time cell voltages are reported. A red indicator means that the cell voltage is either too high (> 5V) or too low (< 1.5V).
3	OW	Read	These indicators report the result of the most recent open-wire detection. Gray boxes indicate no open-wire detection has yet been requested. Refer to the MAX14920/MAX14921 IC data sheet for details regarding how to use the status indicators to determine open-wire conditions.
4	Balance	Write	Check these boxes to enable/disable cell balancing for individual cells. When the global cell-balance control is enabled, each checked box activates the cell-balancing switch for that corresponding cell. See the <i>Detailed Description of Hardware</i> section for more details.
5	Pack	Read	This field reports the mathematical sum of the individual cell voltages. It is the voltage of the entire cell stack.

Auxiliary Input Section

The device also has three general-purpose analog inputs (T1–T3) whose voltages can also be presented to the ADC. Unlike the cell voltage inputs, the T_ inputs are neither level shifted nor sampled. The auxiliary input section provides a way to see these T inputs in action. Figure 8 and Table 4 detail the available control and actions.

Streaming Data to a File

The EV kit can collect cell and T_ input data and stream it to a file. This is when the repeat time parameter is used. At the default setting of 10ms, data is logged at 100 data sets per second.

To stream cell data, push the “Stream to File” control. A “Save As” dialog box opens to select a file to write the data to. Once a file is selected, click the “Save” button. Streaming continues until the “Stop Streaming” control is pushed. Note that you can quickly end up with large files.

Stream Data File Format

The data is stored in the streaming file as text. The first line indicates what range of cell data is captured, up to 16 cells, and whether each T_ input is also captured or not. Each subsequent line or pair of lines represents one captured data set.

Actual data starts with the second line. This line records up to 16 cell voltages, starting with the highest numbered cell down to the first cell (cell 1). If any of the T_ inputs are enabled, the next line is up to 3 T_ input voltages. If no T_ input is enabled, the third line is instead the next set of cell voltages, captured one repeat time later.

For example, in Figure 10, the first line of the file indicates that all 16 cell voltages are captured, as well as all three auxiliary inputs. The second line shows that cell 16 read 0.0392V and cell 15 read 0.0160V. The third line shows that T1 read 1.1506V, T2 read 4.0587V, and T3 read 4.0950V. This occurred at one time instant. The fourth and fifth line would report the cell and auxiliary inputs, like lines 2 and 3, only one repeat time later. Note that at the default 100 samples per second (10ms repeat time), the data file can quickly grow quite large.

Table 4. EV Kit Auxiliary Input Section Details (Figure 8)

ITEM	LABEL	READ/WRITE	DESCRIPTION
1	Voltage	Read	These are the voltages read from the corresponding T_ input. Each T_ input must be enabled for its voltage to be acquired and displayed.
2	Enable	Write	Check the box to enable or disable the corresponding T_ input. When enabled, the T_ input voltage is read and converted at the same repetition rate as the cell voltages.
3	Buffer	Write	Check the box to enable or disable the optional buffer for each T_ input. When unchecked, the corresponding T_ input connects directly to the ADC. Use this setting for high-drive analog sources. When checked, the T_ input is unity-gain buffered to the ADC. Use this for low-drive analog signals.
4	Settling Delay	Write	This is the delay time, in microseconds, from when the device presents a T_ signal to when the ADC conversion begins.

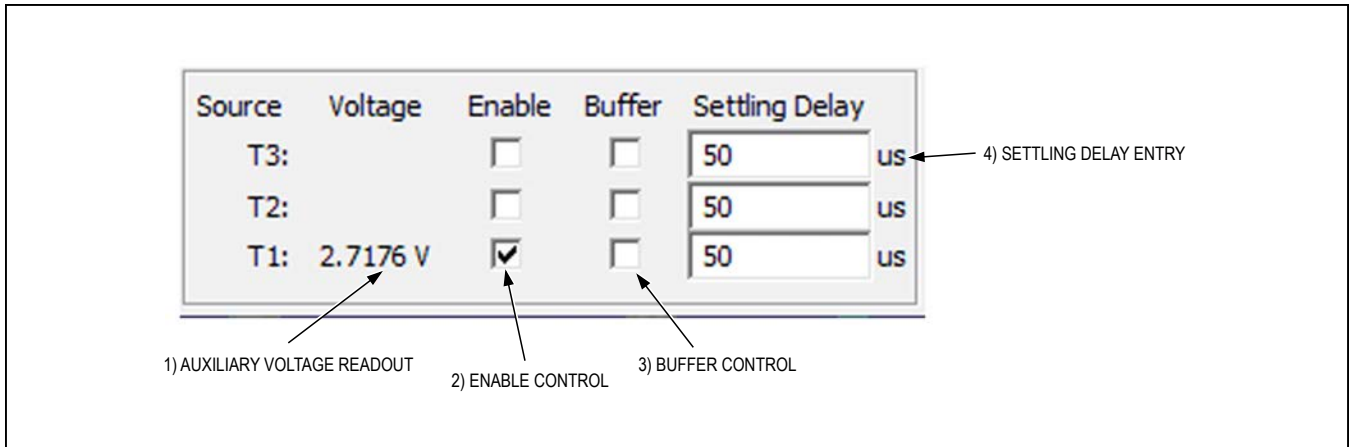

Figure 8. Auxiliary Input Section

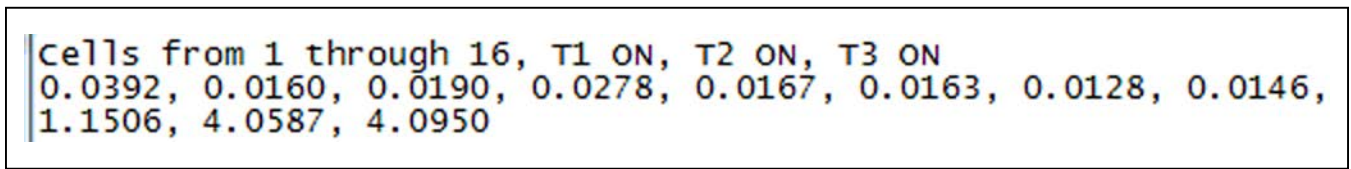

Figure 9. Example Streaming Data Output

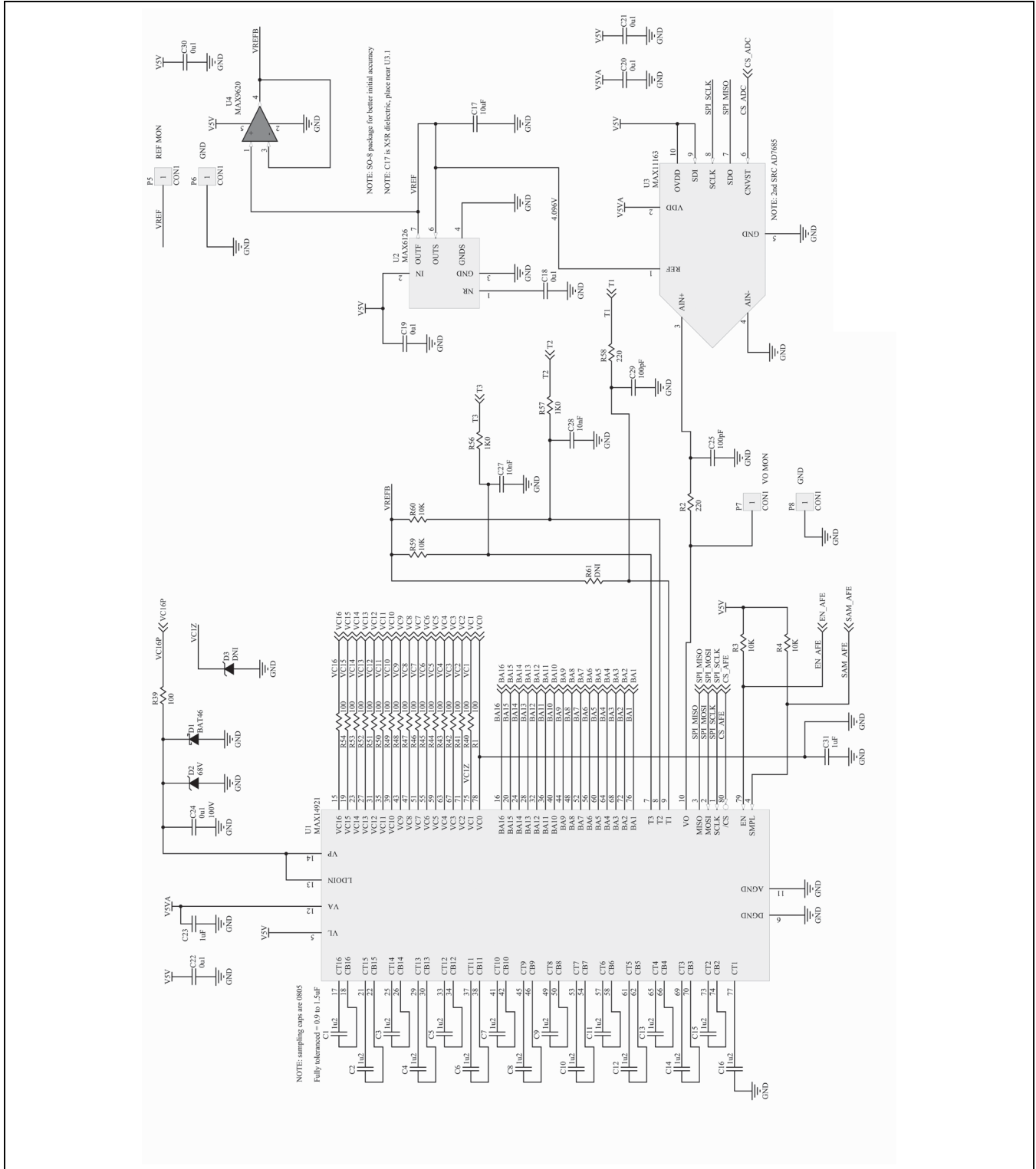

Figure 10a. MAX14921 EV Kit Schematic (Sheet 1 of 5)

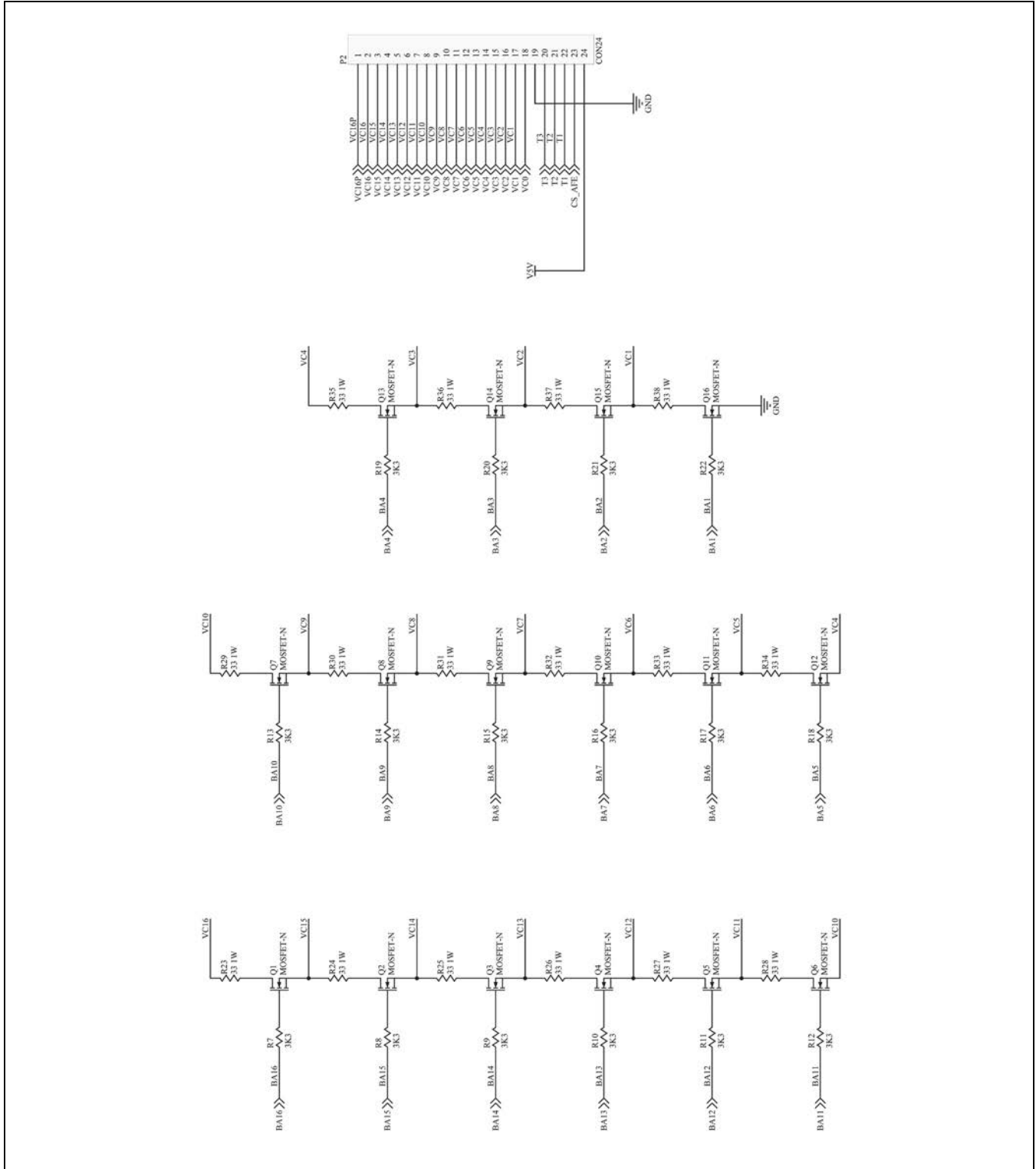

Figure 10b. MAX14921 EV Kit Schematic (Sheet 2 of 5)

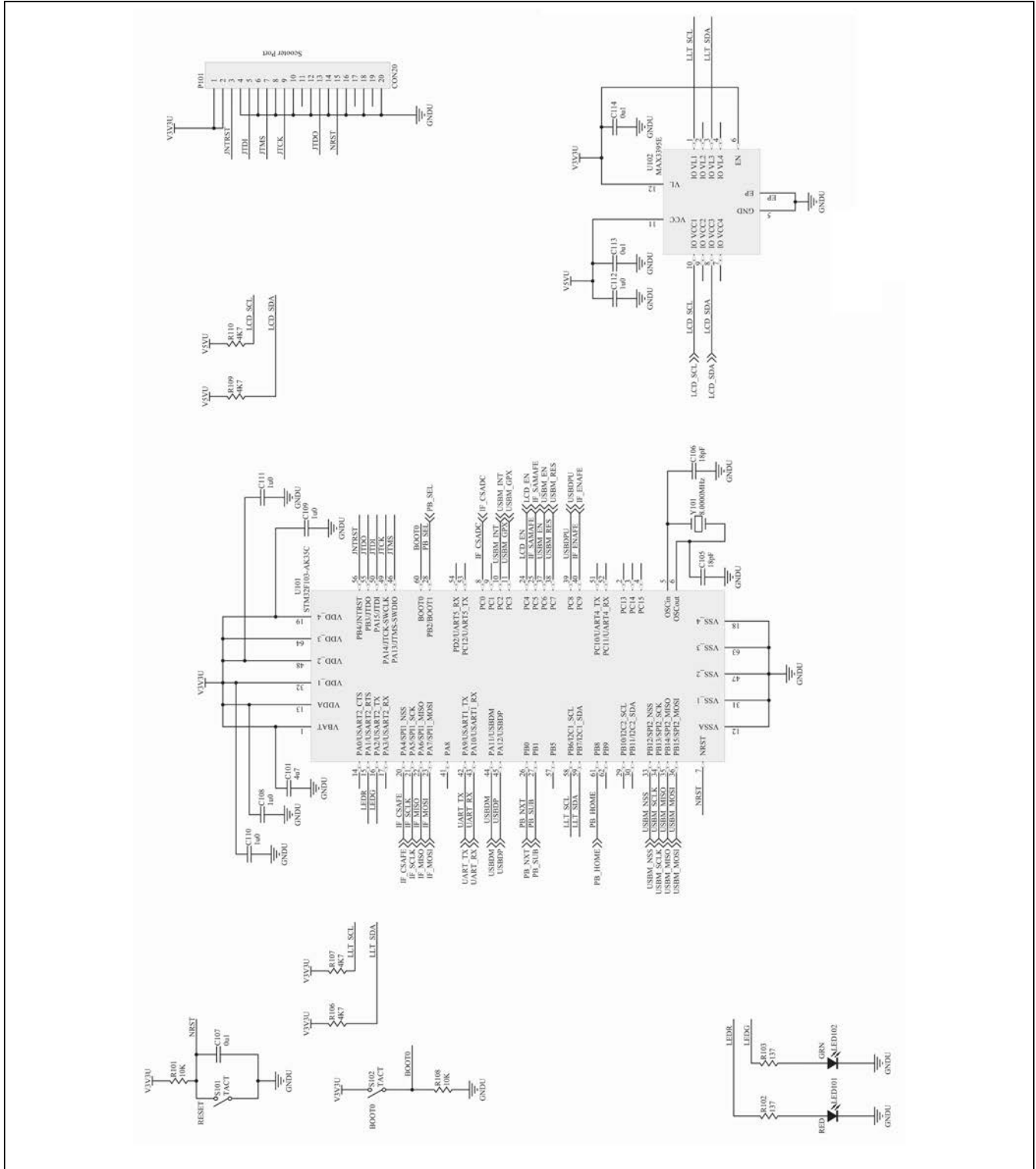

Figure 10c. MAX14921 EV Kit Schematic (Sheet 3 of 5)

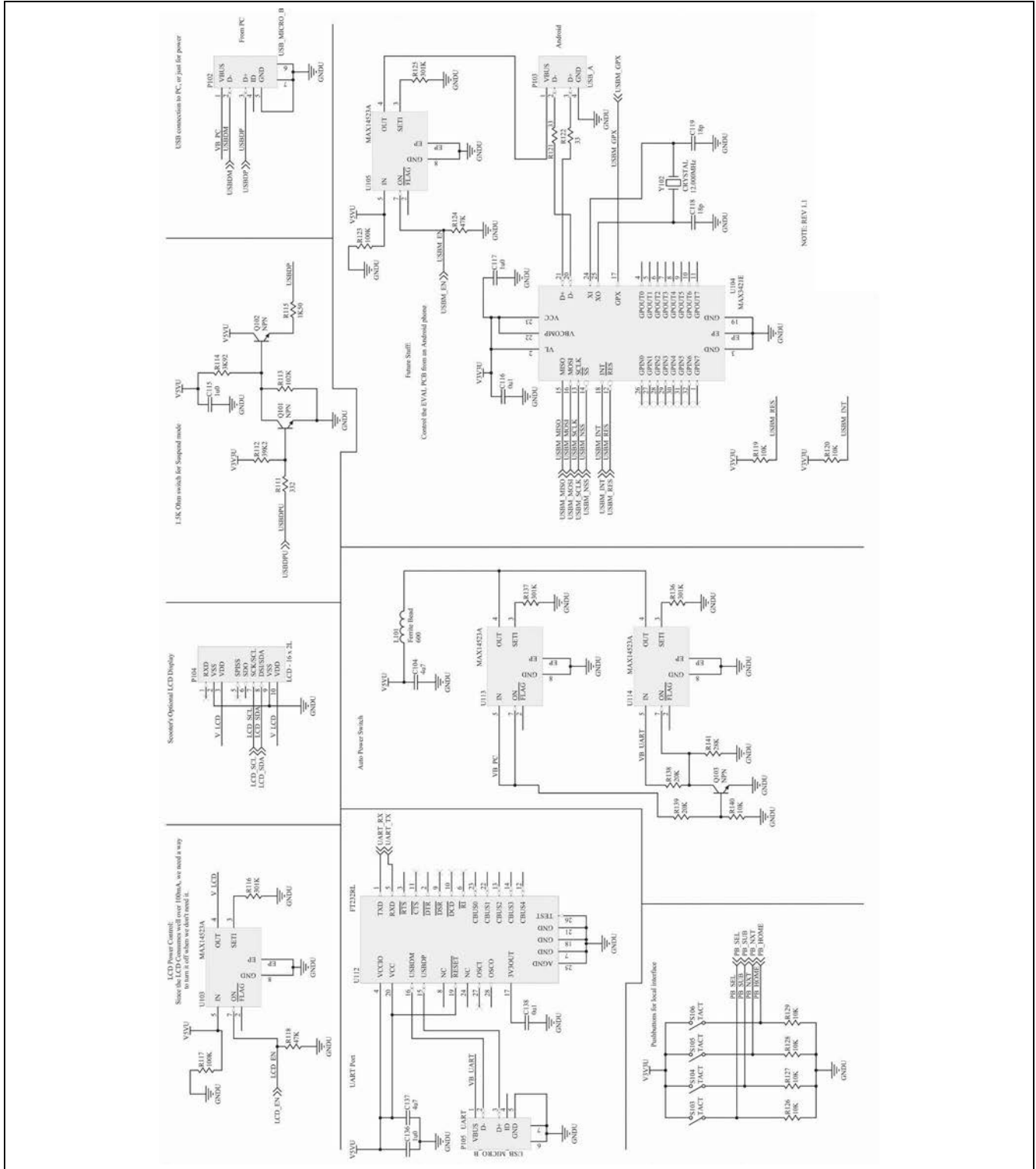

Figure 10d. MAX14921 EV Kit Schematic (Sheet 4 of 5)

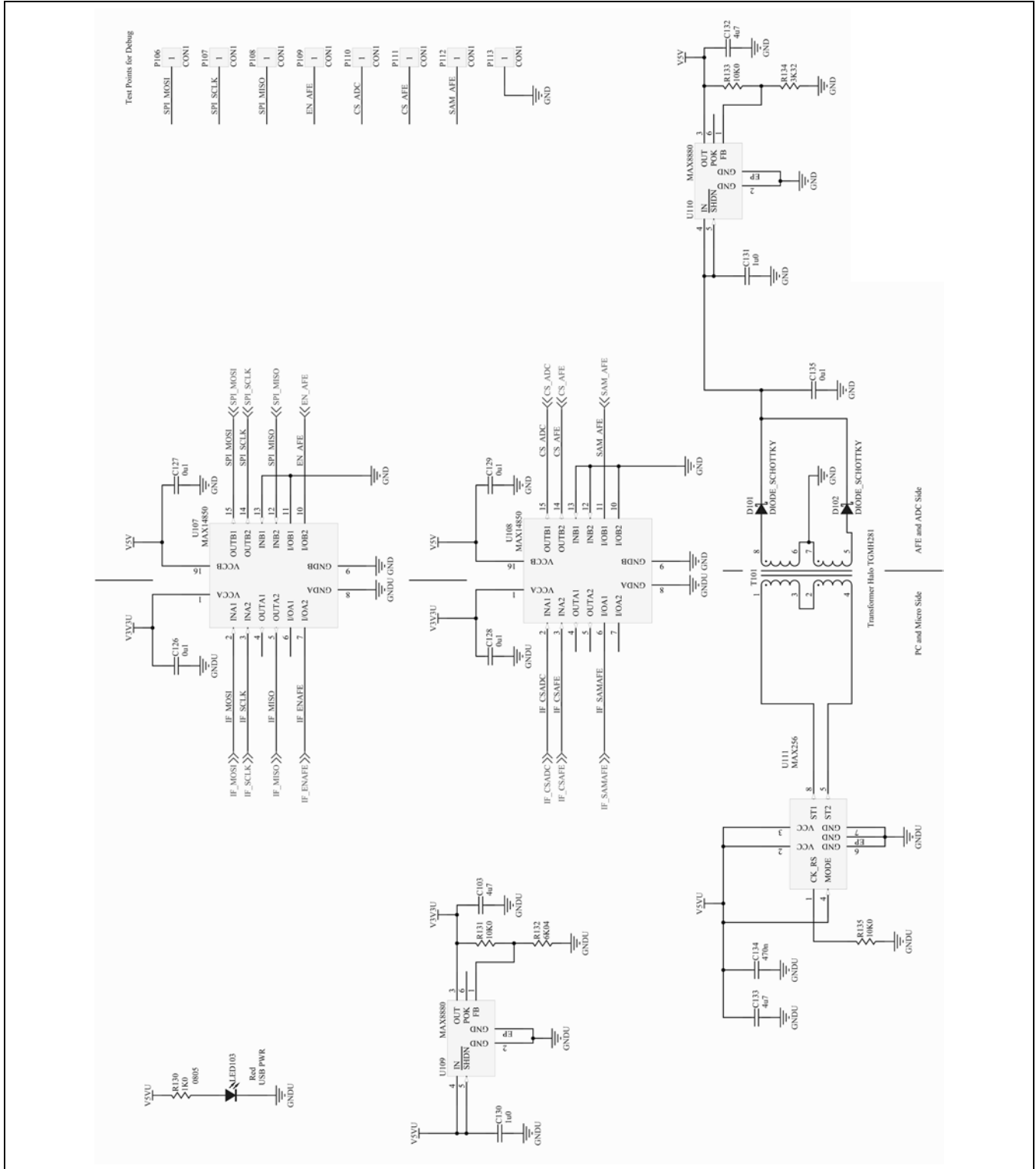

Figure 10e. MAX14921 EV Kit Schematic (Sheet 5 of 5)

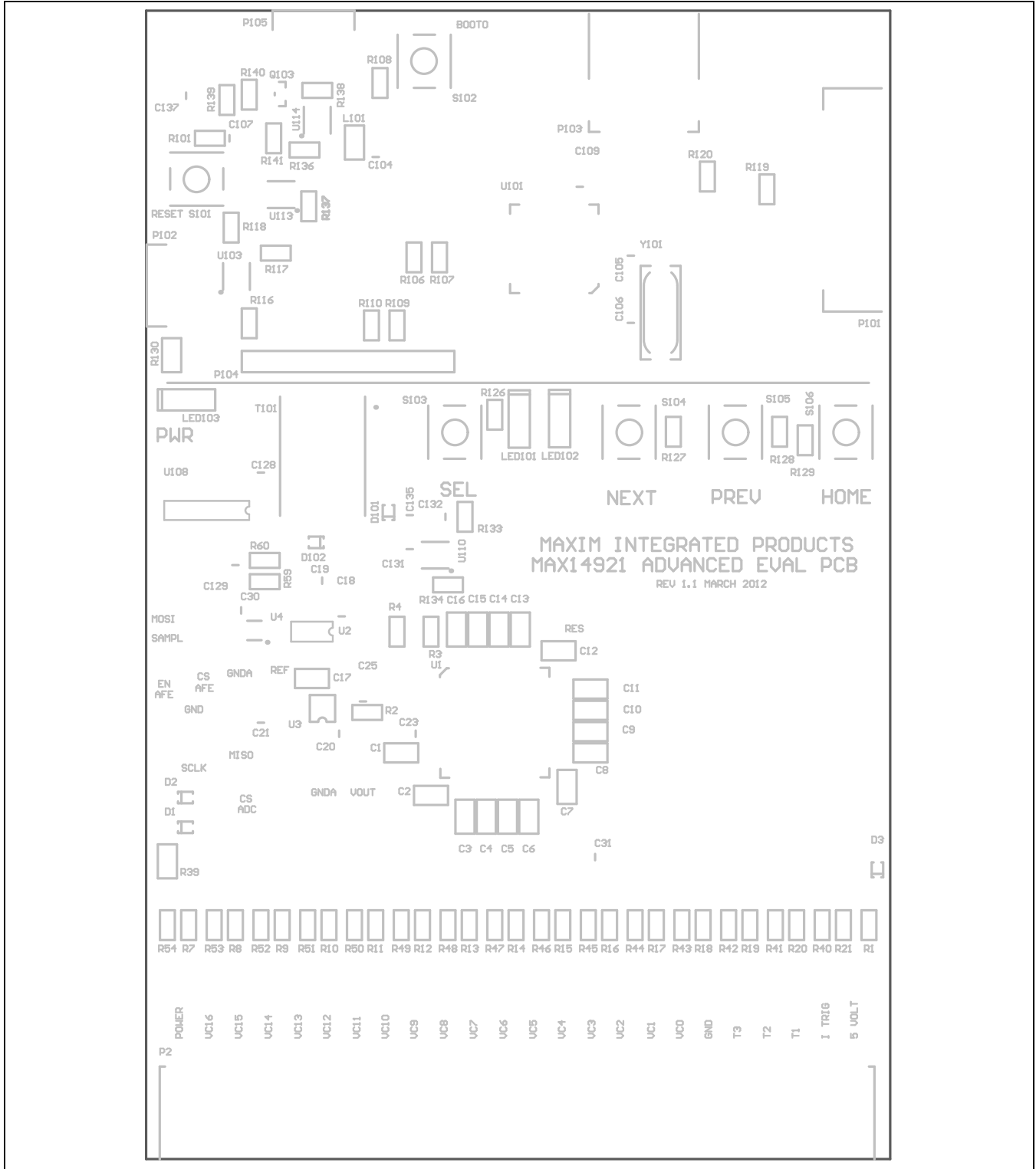

Figure 11. MAX14921 EV Kit Component Placement Guide—Component Side

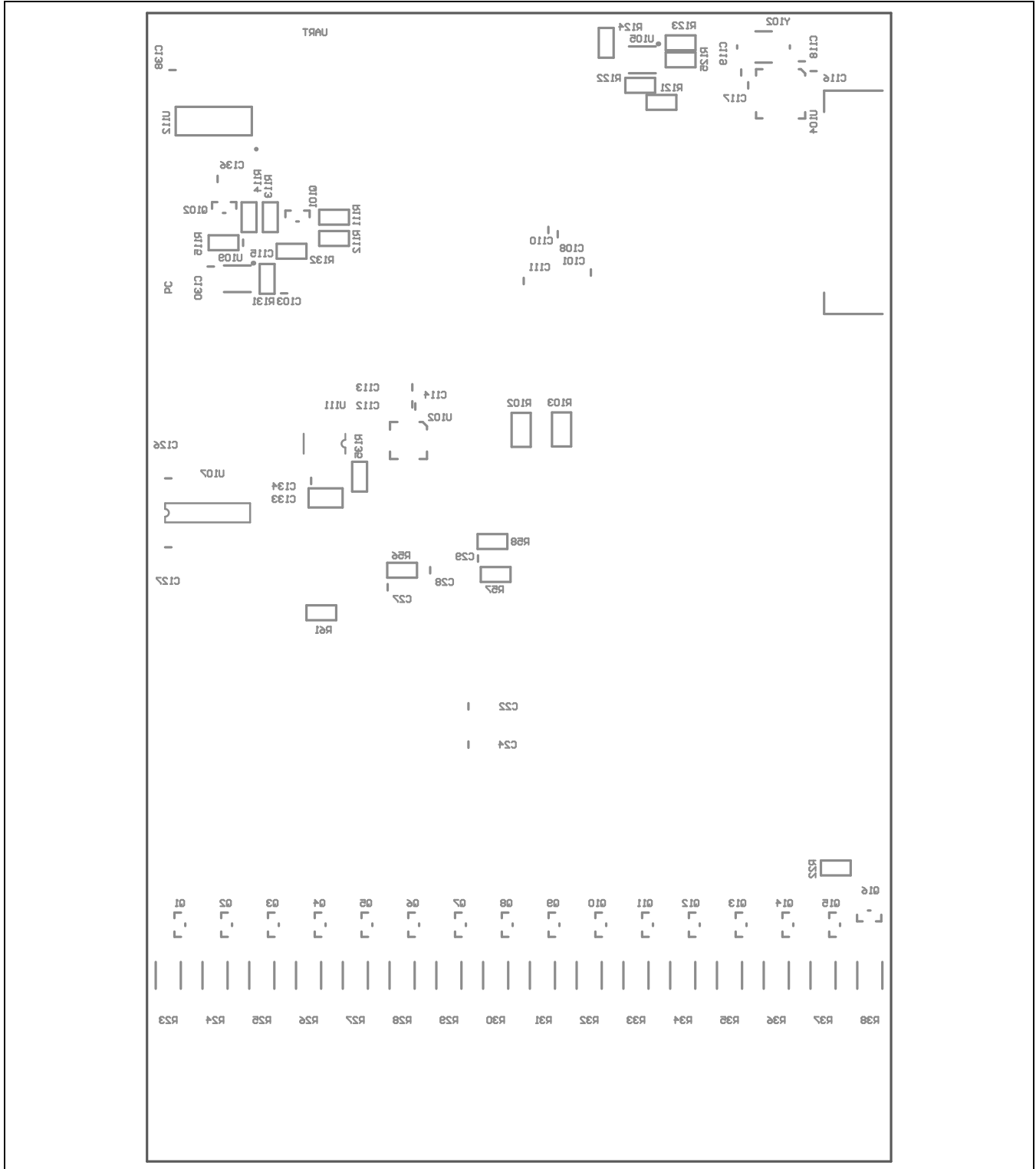

Figure 12. MAX14921 EV Kit Component Placement Guide—Solder Side

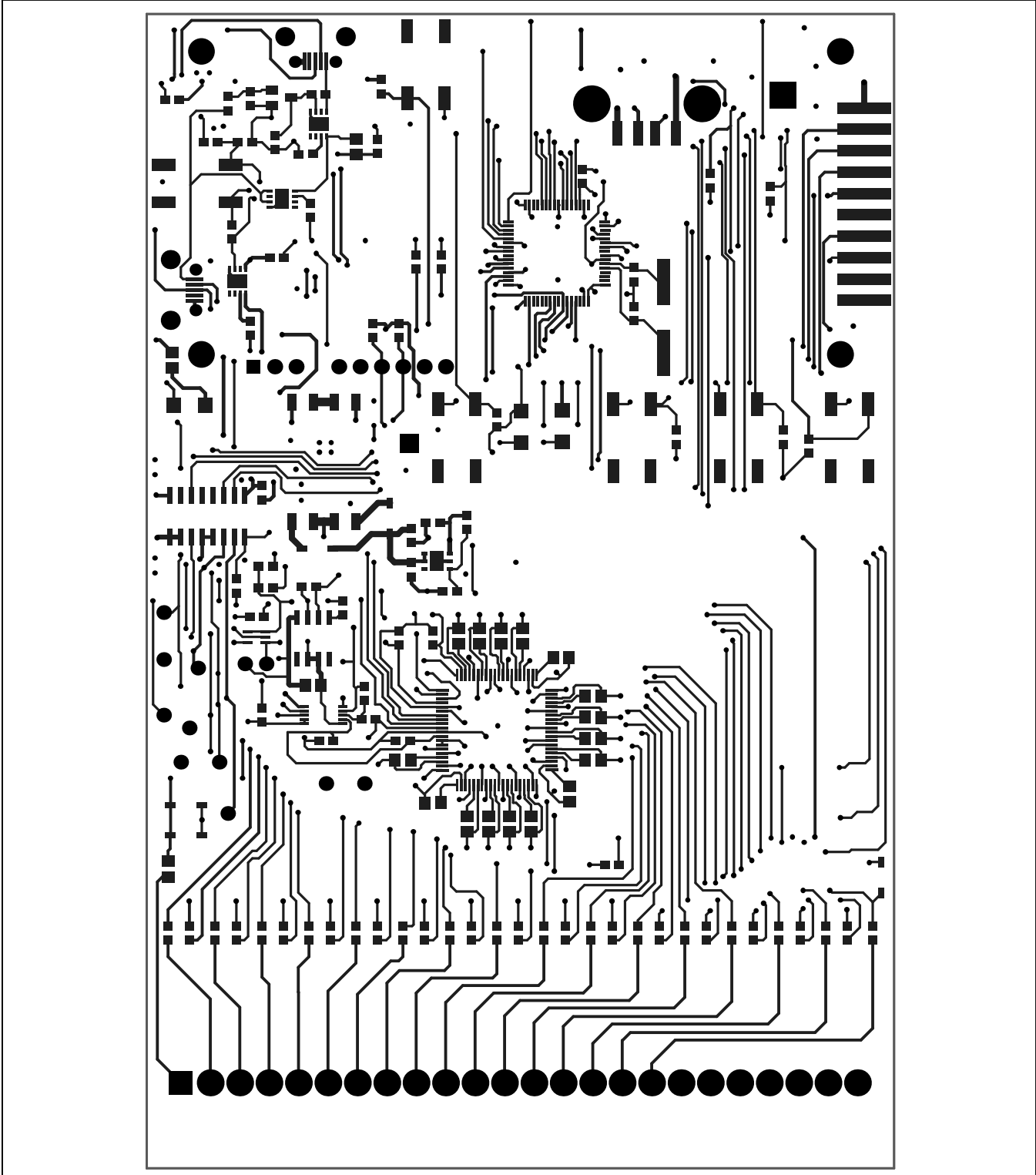

Figure 13. MAX14921 EV Kit PCB Layout—Top Copper

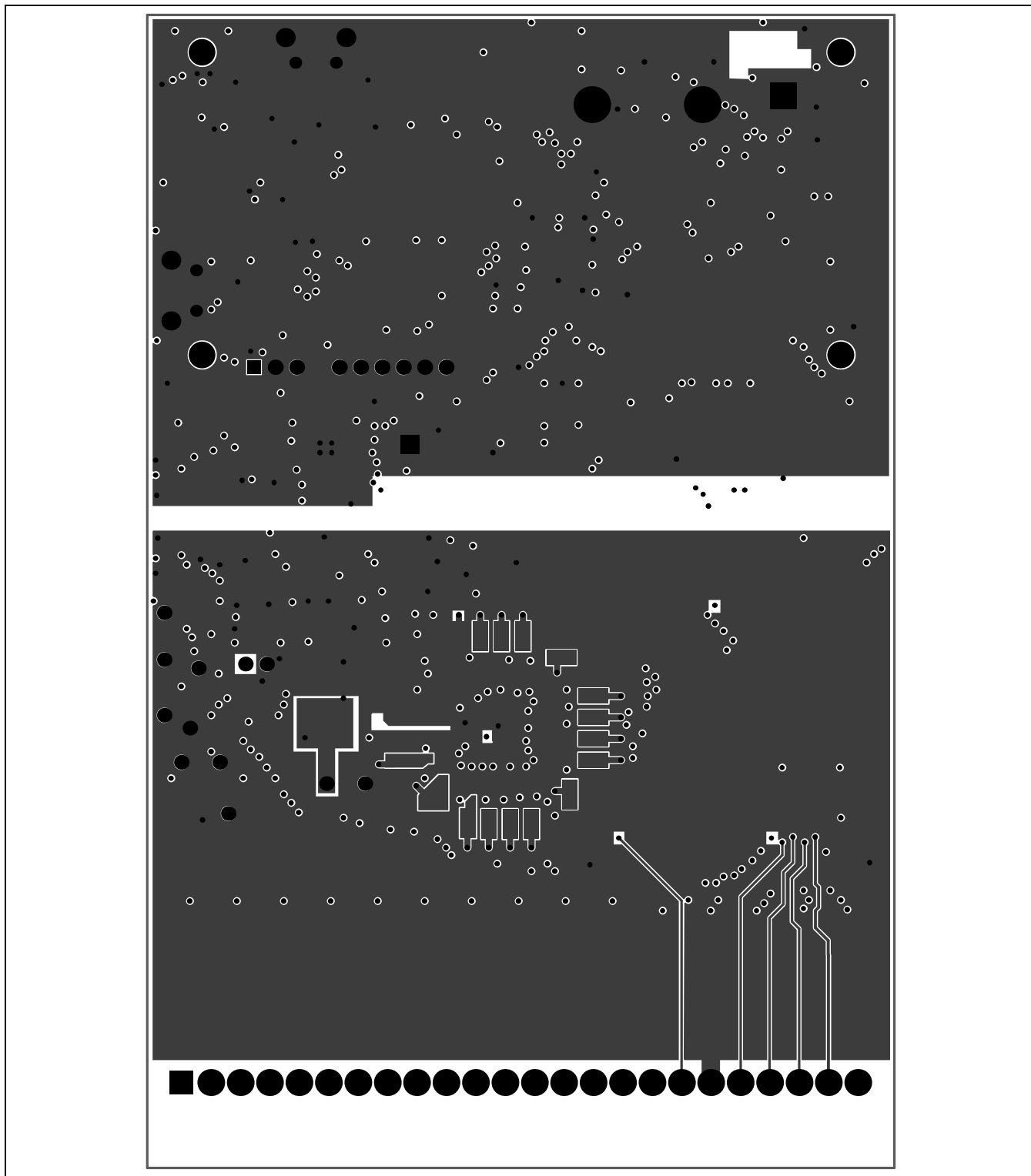

Figure 14. MAX14921 EV Kit PCB Layout—Layer 2 (Ground)

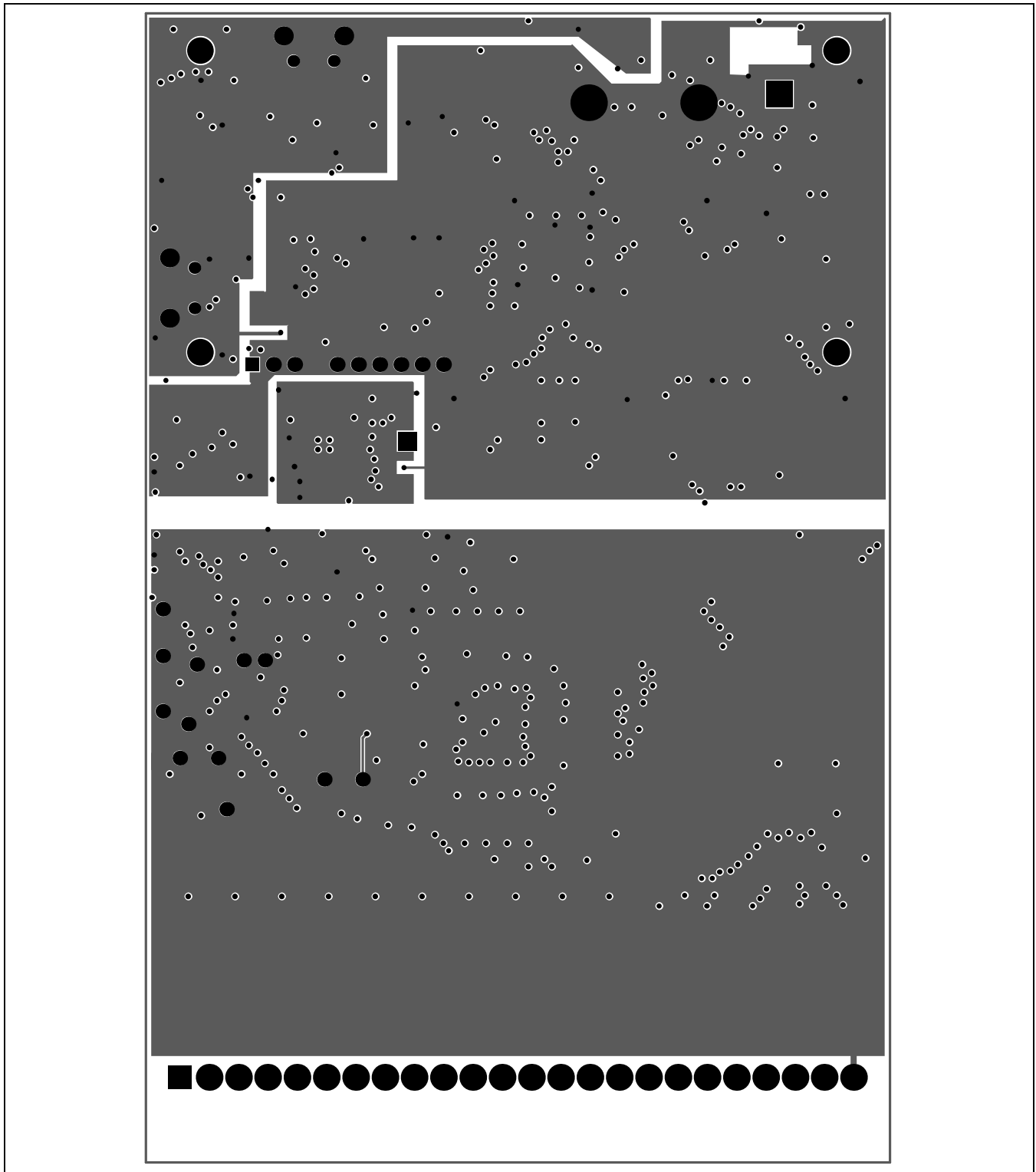

Figure 15. MAX14921 EV Kit PCB Layout—Layer 3 (Power)

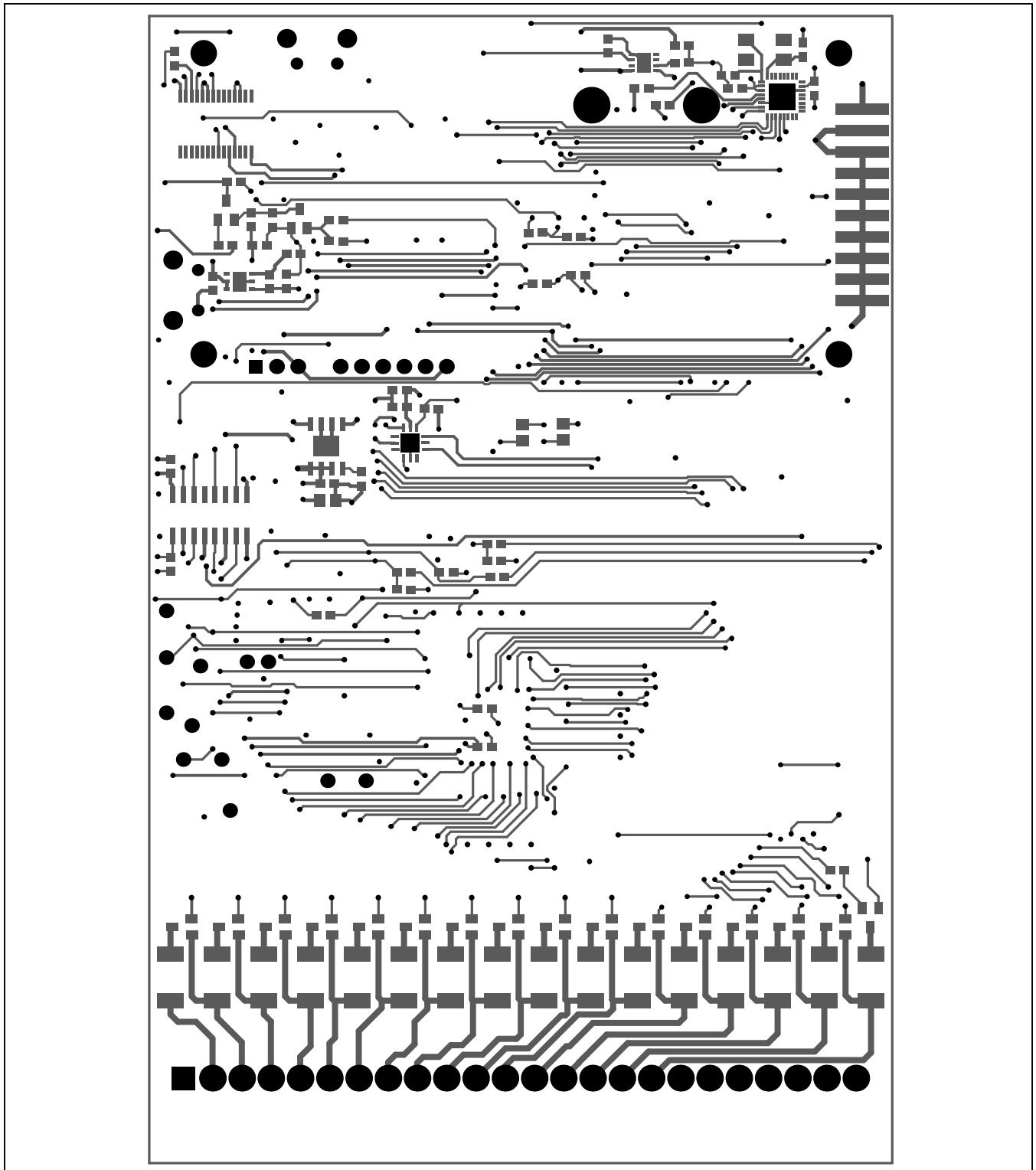
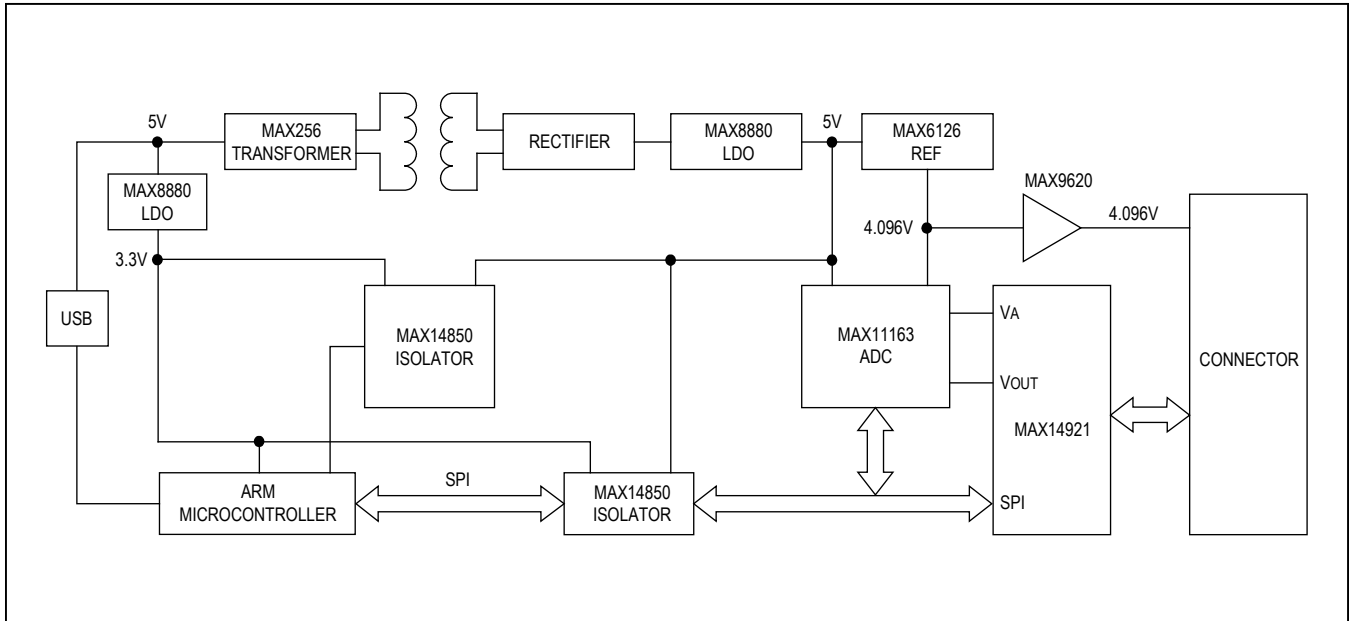

Figure 16. MAX14921 EV Kit PCB Layout—Bottom Copper

Block Diagram



Ordering Information

PART	TYPE
MAX14921EVKIT#	EV Kit

#Denotes RoHS compliant.

Revision History

REVISION NUMBER	REVISION DATE	DESCRIPTION	PAGES CHANGED
0	4/13	Initial release	—

For pricing, delivery, and ordering information, please contact Maxim Direct at 1-888-629-4642, or visit Maxim Integrated's website at www.maximintegrated.com.

Maxim Integrated cannot assume responsibility for use of any circuitry other than circuitry entirely embodied in a Maxim Integrated product. No circuit patent licenses are implied. Maxim Integrated reserves the right to change the circuitry and specifications without notice at any time.