

### FEATURES

- Main input voltage range: 2.3 V to 5.5 V
- Two 800 mA buck regulators and two 300 mA LDOs
- Tiny, 16-ball, 2 mm × 2 mm WLCSP package
- Regulator accuracy: ±1.8%
- Factory programmable VOUTx
- 3 MHz buck operation with forced PWM and auto PWM/PSM modes
- BUCK1/BUCK2: output voltage range from 0.8 V to 3.8 V
- LDO1/LDO2: output voltage range from 0.8 V to 5.2 V
- LDO1/LDO2: low input supply voltage from 1.7 V to 5.5 V
- LDO1/LDO2: high PSRR and low output noise

### APPLICATIONS

- Power for processors, ASICs, FPGAs, and RF chipsets
- Portable instrumentation and medical devices
- Space constrained devices

### GENERAL DESCRIPTION

The ADP5033 combines two high performance buck regulators and two low dropout regulators (LDO) in a tiny, 16-ball, 2 mm × 2 mm WLCSP to meet demanding performance and board space requirements.

The high switching frequency of the buck regulators enables tiny multilayer external components and minimizes the board space. When the MODE pin is set high, the buck regulators operate in forced PWM mode. When the MODE pin is set low, the buck regulators operate in PWM mode when the load current is above a predefined threshold. When the load current falls below a predefined threshold, the regulator operates in power save mode (PSM), improving the light load efficiency.

The two bucks operate out of phase to reduce the input capacitor requirement and noise.

The low quiescent current, low dropout voltage, and wide input voltage range of the ADP5033 LDO extend the battery life of portable devices. The ADP5033 LDOs maintain power supply rejection greater than 60 dB for frequencies as high as 10 kHz while operating with a low headroom voltage.

### TYPICAL APPLICATION CIRCUIT

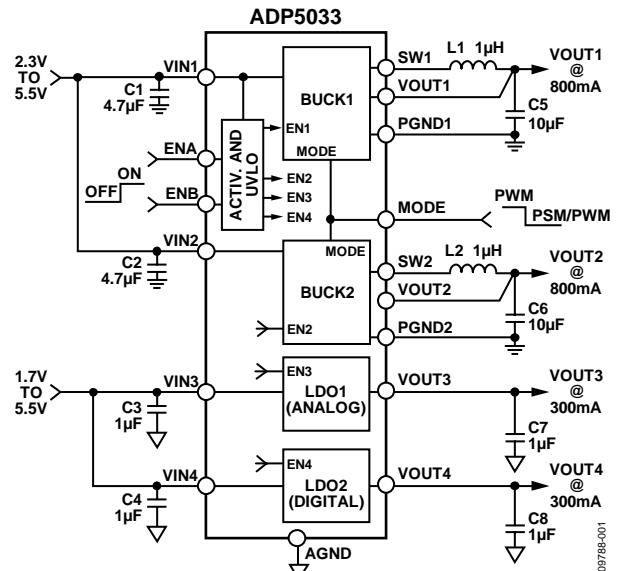

Figure 1.

The regulators in the ADP5033 are activated by the ENA and ENB pins. The specific channels controlled by ENA and ENB are set by factory programming. A high voltage level applied to the enable pins activates the regulators. The default output voltages are factory programmable and can be set to a wide range of options.

Table 1. Family Models

Model	Channels	Maximum Current	Package
ADP5023	2 Bucks, 1 LDO	800 mA, 300 mA	LFCSP (CP-24-10)
ADP5024	2 Bucks, 1 LDO	1.2 A, 300 mA	LFCSP (CP-24-10)
ADP5034	2 Bucks, 2 LDOs	1.2 A, 300 mA	LFCSP (CP-24-10), TSSOP (RE-28-1)
ADP5037	2 Bucks, 2 LDOs	800 mA, 300 mA	LFCSP (CP-24-10)
ADP5033	2 Bucks, 2 LDOs with 2 EN pins	800 mA, 300 mA	WLCSP (CB-16-8)
ADP5040	1 Buck, 2 LDOs	1.2 A, 300 mA	LFCSP (CP-20-10)
ADP5041	1 Buck, 2 LDOs with Supervisory, Watchdog, Manual Reset	1.2 A, 300 mA	LFCSP (CP-20-10)
ADP5133	2 Bucks with 2 ENx pins	800 mA	WLCSP (CB-16-8)
ADP5134	2 Bucks, 2 LDOs with precision enable and power-good output	1.2 A, 300 mA	LFCSP (CP-24-10)

## TABLE OF CONTENTS

Features .....	1
Applications.....	1
Typical Application Circuit .....	1
General Description .....	1
Revision History .....	2
Specifications.....	3
General Specifications .....	3
BUCK1 and BUCK2 Specifications .....	4
LDO1 and LDO2 Specifications.....	4
Input and Output Capacitor, Recommended Specifications .....	5
Absolute Maximum Ratings.....	6
Thermal Resistance .....	6
ESD Caution.....	6
Pin Configuration and Function Descriptions.....	7
Typical Performance Characteristics .....	8

### REVISION HISTORY

#### 3/2019—Rev. G to Rev. H

Changes to Ordering Guide .....	26
---------------------------------	----

#### 9/2014—Rev. F to Rev. G

Changes to Page Layout .....	1
Changes to Table 1.....	1
Changes to Ordering Guide .....	26

#### 10/2013—Rev. E to Rev. F

Changes to VIN1 Undervoltage Lockout Parameter, Table 2.....	3
Changes to Undervoltage Lockout Section .....	16
Moved Ordering Guide.....	26
Changes to Ordering Guide .....	26

#### 9/2013—Rev. D to Rev. E

Changes to Table 1.....	1
Changes to Ordering Guide .....	25

#### 5/2013—Rev. C to Rev. D

Added Table 1; Renumbered Sequentially .....	1
Changes to Ordering Guide .....	25

#### 1/2013—Rev. B to Rev. C

Changes to Figure 9.....	9
Changes to Ordering Guide .....	25

#### 10/2012—Rev. A to Rev. B

Changes to Features Section.....	1
Changes to Buck Output Voltage Accuracy Parameter, Table 2 .....	4
Changes to LDO Output Voltage Accuracy Parameter, Table 3 .....	4
Changes to Figure 6 to Figure 8 .....	8
Changes to Figure 30 to Figure 32.....	12

Theory of Operation .....	15
Power Management Unit.....	15
BUCK1 and BUCK2 .....	16
LDO1 and LDO2.....	17
Applications Information .....	18
Buck External Component Selection.....	18
LDO Capacitor Selection .....	20
Power Dissipation and Thermal Considerations .....	21
Buck Regulator Power Dissipation .....	21
Junction Temperature .....	22
PCB Layout Guidelines.....	23
Typical Application Schematic .....	24
Outline Dimensions .....	25
Ordering Guide .....	26

Changes to Figure 36 Caption .....	13
Changes to Undervoltage Lockout Section.....	16
Moved Power Dissipation and Thermal Considerations Section....	21
Changes to Buck Regulator Power Dissipation Section .....	21
Updated Outline Dimensions.....	25
Changes to Ordering Guide .....	25

#### 1/2012—Rev. 0 to Rev. A

Changes to Features Section and General Description Section .....	1
Changes to Output Characteristics Parameter, Table 2.....	4
Changes to Output Characteristics Parameter, Table 3 and Dropout Voltage Parameter, Table 3 .....	4
Changes to Nominal Input and Output Capacitor Ratings Parameter, Table 4 .....	5
Changes to Table 5.....	6
Changed $V_{IN1} = V_{IN2} = V_{IN3} = V_{IN4} = 5.0\text{ V}$ to $V_{IN1} = V_{IN2} = V_{IN3} = V_{IN4} = 3.6\text{ V}$ .....	8
Changes to Figure 4 to Figure 8.....	8
Change to Figure 15 Caption and Figure 17 Caption.....	10
Changes Figure 19 and Figure 20 .....	10
Changes to Figure 31 and Figure 32 .....	12
Changes to Figure 33, Figure 37, and Figure 38 .....	13
Changes to Buck Regulator Power Dissipation Section .....	15
Changes to LDO Regulator Power Dissipation Section and Junction Temperature Section .....	16
Changes to Undervoltage Lockout Section.....	18
Changes to LDO1 and LDO2 Section .....	19
Changes to Output Capacitor Section .....	20
Changes to Table 9.....	21
Change to Input and Output Capacitor Properties Section .....	22
Changes to Ordering Guide .....	25

#### 5/2011—Revision 0: Initial Version

## SPECIFICATIONS

### GENERAL SPECIFICATIONS

$V_{IN1} = V_{IN2} = V_{IN3} = V_{IN4} = 2.3 \text{ V to } 5.5 \text{ V}$ ;  $V_{IN3} = V_{IN4} = 1.7 \text{ V to } 5.5 \text{ V}$ ;  $T_J = -40^\circ\text{C to } +125^\circ\text{C}$  for minimum/maximum specifications, and  $T_A = 25^\circ\text{C}$  for typical specifications, unless otherwise noted.

Table 2.

Parameter	Symbol	Test Conditions/Comments	Min	Typ	Max	Unit
INPUT VOLTAGE RANGE	$V_{IN1}, V_{IN2}$		2.3		5.5	V
THERMAL SHUTDOWN						
Threshold	$T_{SD}$	$T_J$ rising		150		$^\circ\text{C}$
Hysteresis	$T_{SD-HYS}$			20		$^\circ\text{C}$
START-UP TIME <sup>1</sup>						
BUCK1, LDO1, LDO2	$t_{START1}$			250		$\mu\text{s}$
BUCK2	$t_{START2}$			300		$\mu\text{s}$
ENA, ENB, MODE INPUTS						
Input Logic High	$V_{IH}$		1.1			V
Input Logic Low	$V_{IL}$				0.4	V
Input Leakage Current	$V_{I-LEAKAGE}$			0.05	1	$\mu\text{A}$
STANDBY CURRENT						
All Channels Enabled	$I_{STBY-NOSW}$	No load, no buck switching		108	175	$\mu\text{A}$
All Channels Disabled	$I_{SHUTDOWN}$	$T_J = -40^\circ\text{C to } +85^\circ\text{C}$		0.3	1	$\mu\text{A}$
VIN1 UNDERVOLTAGE LOCKOUT						
Low UVLO Input Voltage Rising	$UVLO_{VIN1RISE}$				2.275	V
Low UVLO Input Voltage Falling	$UVLO_{VIN1FALL}$		1.95			V

<sup>1</sup> Start-up time is defined as the time from  $V_{IN1} > UVLO_{VIN1RISE}$  to  $V_{OUT1}, V_{OUT2}, V_{OUT3},$  and  $V_{OUT4}$  reaching 90% of their nominal levels.

**BUCK1 AND BUCK2 SPECIFICATIONS**

$V_{IN1} = V_{IN2} = 2.3 \text{ V to } 5.5 \text{ V}$ ;  $T_J = -40^\circ\text{C to } +125^\circ\text{C}$  for minimum/maximum specifications, and  $T_A = 25^\circ\text{C}$  for typical specifications, unless otherwise noted.<sup>1</sup>

**Table 3.**

Parameter	Symbol	Test Conditions/Comments	Min	Typ	Max	Unit
INPUT CHARACTERISTICS						
Input Voltage Range	$V_{IN1}, V_{IN2}$	PWM mode, $I_{LOAD1} = I_{LOAD2} = 0 \text{ mA to } 800 \text{ mA}$	2.3		5.5	V
OUTPUT CHARACTERISTICS						
Output Voltage Accuracy	$\Delta V_{OUT1}/V_{OUT1}, \Delta V_{OUT2}/V_{OUT2}$	PWM mode; $I_{LOAD1} = I_{LOAD2} = 0 \text{ mA}$	-1.8		+1.8	%
Line Regulation	$(\Delta V_{OUT1}/V_{OUT1})/\Delta V_{IN1},$ $(\Delta V_{OUT2}/V_{OUT2})/\Delta V_{IN2}$	PWM mode		-0.05		%/V
Load Regulation	$(\Delta V_{OUT1}/V_{OUT1})/\Delta I_{OUT1},$ $(\Delta V_{OUT2}/V_{OUT2})/\Delta I_{OUT2}$	$I_{LOAD} = 0 \text{ mA to } 800 \text{ mA}$ , PWM mode		-0.1		%/A
PSM CURRENT THRESHOLD						
PSM to PWM Operation	$I_{PSM}$			100		mA
OPERATING SUPPLY CURRENT		MODE = ground				
BUCK1 Only	$I_{IN}$	$I_{LOAD1} = 0 \text{ mA}$ , device not switching, all other channels disabled		44		$\mu\text{A}$
BUCK2 Only	$I_{IN}$	$I_{LOAD2} = 0 \text{ mA}$ , device not switching, all other channels disabled		55		$\mu\text{A}$
BUCK1 and BUCK2	$I_{IN}$	$I_{LOAD1} = I_{LOAD2} = 0 \text{ mA}$ , device not switching, LDO channels disabled		67		$\mu\text{A}$
SW CHARACTERISTICS						
SW On Resistance	$R_{PFET}$	PFET at $V_{IN1} = 5 \text{ V}$		145	235	m $\Omega$
	$R_{PFET}$	PFET at $V_{IN1} = 3.6 \text{ V}$		180	295	m $\Omega$
	$R_{NFET}$	NFET at $V_{IN1} = 5 \text{ V}$		110	190	m $\Omega$
	$R_{NFET}$	NFET at $V_{IN1} = 3.6 \text{ V}$		125	220	m $\Omega$
Current Limit	$I_{LIMIT1}, I_{LIMIT2}$	PFET switch peak current limit	1100	1350		mA
ACTIVE PULL-DOWN	$R_{PDWN-B}$	Channel disabled		75		$\Omega$
OSCILLATOR FREQUENCY	$f_{SW}$		2.5	3.0	3.5	MHz

<sup>1</sup> All limits at temperature extremes are guaranteed via correlation using standard statistical quality control (SQC).

**LDO1 AND LDO2 SPECIFICATIONS**

$V_{IN3} = (V_{OUT3} + 0.5 \text{ V})$  or  $1.7 \text{ V}$  (whichever is greater) to  $5.5 \text{ V}$ ,  $V_{IN4} = (V_{OUT4} + 0.5 \text{ V})$  or  $1.7 \text{ V}$  (whichever is greater) to  $5.5 \text{ V}$ ;  $C_{IN} = C_{OUT} = 1 \mu\text{F}$ ;  $T_J = -40^\circ\text{C to } +125^\circ\text{C}$  for minimum/maximum specifications, and  $T_A = 25^\circ\text{C}$  for typical specifications, unless otherwise noted.<sup>1</sup>

**Table 4.**

Parameter	Symbol	Test Conditions/Comments	Min	Typ	Max	Unit
INPUT VOLTAGE RANGE	$V_{IN3}, V_{IN4}$		1.7		5.5	V
OPERATING SUPPLY CURRENT						
Bias Current per LDO <sup>2</sup>	$I_{VIN3BIAS}/I_{VIN4BIAS}$	$I_{OUT3} = I_{OUT4} = 0 \mu\text{A}$		10	30	$\mu\text{A}$
		$I_{OUT3} = I_{OUT4} = 10 \text{ mA}$		60	100	$\mu\text{A}$
		$I_{OUT3} = I_{OUT4} = 300 \text{ mA}$		165	245	$\mu\text{A}$
Total System Input Current	$I_{IN}$	Includes all current into $V_{IN1}, V_{IN2}, V_{IN3}$ , and $V_{IN4}$				
LDO1 or LDO2 Only		$I_{OUT3} = I_{OUT4} = 0 \mu\text{A}$ , all other channels disabled		53		$\mu\text{A}$
LDO1 and LDO2 Only		$I_{OUT3} = I_{OUT4} = 0 \mu\text{A}$ , buck channels disabled		74		$\mu\text{A}$
OUTPUT CHARACTERISTICS						
Output Voltage Accuracy	$\Delta V_{OUT3}/V_{OUT3},$ $\Delta V_{OUT4}/V_{OUT4}$	$100 \mu\text{A} < I_{OUT3} < 300 \text{ mA}, 100 \mu\text{A} < I_{OUT4} < 300 \text{ mA}$	-1.8		+1.8	%
Line Regulation	$(\Delta V_{OUT3}/V_{OUT3})/\Delta V_{IN3},$ $(\Delta V_{OUT4}/V_{OUT4})/\Delta V_{IN4}$	$I_{OUT3} = I_{OUT4} = 1 \text{ mA}$	-0.03		+0.03	%/V
Load Regulation <sup>3</sup>	$(\Delta V_{OUT3}/V_{OUT3})/\Delta I_{OUT3},$ $(\Delta V_{OUT4}/V_{OUT4})/\Delta I_{OUT4}$	$I_{OUT3} = I_{OUT4} = 1 \text{ mA to } 300 \text{ mA}$		0.001	0.003	%/mA

Parameter	Symbol	Test Conditions/Comments	Min	Typ	Max	Unit
DROPOUT VOLTAGE <sup>4</sup>	V <sub>DROPOUT</sub>	V <sub>OUT3</sub> = V <sub>OUT4</sub> = 5.2 V, I <sub>OUT3</sub> = I <sub>OUT4</sub> = 300 mA		50		mV
		V <sub>OUT3</sub> = V <sub>OUT4</sub> = 3.3 V, I <sub>OUT3</sub> = I <sub>OUT4</sub> = 300 mA		65	110	mV
		V <sub>OUT3</sub> = V <sub>OUT4</sub> = 2.5 V, I <sub>OUT3</sub> = I <sub>OUT4</sub> = 300 mA		85		mV
		V <sub>OUT3</sub> = V <sub>OUT4</sub> = 1.8 V, I <sub>OUT3</sub> = I <sub>OUT4</sub> = 300 mA		165		mV
CURRENT-LIMIT THRESHOLD <sup>5</sup>	I <sub>LIMIT3</sub> , I <sub>LIMIT4</sub>		335	600		mA
ACTIVE PULL-DOWN	R <sub>PDWN-L</sub>	Channel disabled		600		Ω
POWER SUPPLY REJECTION RATIO	PSRR	10 kHz, V <sub>IN3</sub> = 3.3 V, V <sub>OUT3</sub> = 2.8 V, I <sub>OUT3</sub> = 1 mA 100 kHz, V <sub>IN3</sub> = 3.3 V, V <sub>OUT3</sub> = 2.8 V, I <sub>OUT3</sub> = 1 mA 1 MHz, V <sub>IN3</sub> = 3.3 V, V <sub>OUT3</sub> = 2.8 V, I <sub>OUT3</sub> = 1 mA 10 kHz, V <sub>IN4</sub> = 1.8 V, V <sub>OUT4</sub> = 1.2 V, I <sub>OUT4</sub> = 1 mA 100 kHz, V <sub>IN4</sub> = 1.8 V, V <sub>OUT4</sub> = 1.2 V, I <sub>OUT4</sub> = 1 mA 1 MHz, V <sub>IN4</sub> = 1.8 V, V <sub>OUT4</sub> = 1.2 V, I <sub>OUT4</sub> = 1 mA	Regulator LDO1			
				60		dB
				62		dB
				63		dB
			Regulator LDO2			
				54		dB
	57		dB			
	64		dB			

<sup>1</sup> All limits at temperature extremes are guaranteed via correlation using standard statistical quality control (SQC).

<sup>2</sup> This is the input current into VIN3/VIN4, which is not delivered to the output load.

<sup>3</sup> Based on an endpoint calculation using 1 mA and 300 mA loads.

<sup>4</sup> Dropout voltage is defined as the input-to-output voltage differential when the input voltage is set to the nominal output voltage. This applies only to output voltages above 1.7 V.

<sup>5</sup> Current-limit threshold is defined as the current at which the output voltage drops to 90% of the specified typical value. For example, the current limit for a 3.0 V output voltage is defined as the current that causes the output voltage to drop to 90% of 3.0 V, or 2.7 V.

## INPUT AND OUTPUT CAPACITOR, RECOMMENDED SPECIFICATIONS

T<sub>A</sub> = -40°C to +125°C, unless otherwise specified.

Table 5.

Parameter	Symbol	Min	Typ	Max	Unit
NOMINAL INPUT AND OUTPUT CAPACITOR RATINGS					
BUCK1, BUCK2 Input Capacitor Rating	C <sub>MIN1</sub> , C <sub>MIN2</sub>	4.7		40	μF
BUCK1, BUCK2 Output Capacitor Rating	C <sub>MIN1</sub> , C <sub>MIN2</sub>	10		40	μF
LDO1, LDO2 <sup>1</sup> Input and Output Capacitor Rating	C <sub>MIN3</sub> , C <sub>MIN4</sub>	1.0			μF
CAPACITOR ESR	R <sub>ESR</sub>	0.001		1	Ω

<sup>1</sup> The minimum input and output capacitance should be greater than 0.70 μF over the full range of operating conditions. The full range of operating conditions in the application must be considered during device selection to ensure that the minimum capacitance specification is met. X7R- and X5R-type capacitors are recommended; Y5V and Z5U capacitors are not recommended for use because of their poor temperature and dc bias characteristics.

## ABSOLUTE MAXIMUM RATINGS

Table 6.

Parameter	Rating
VIN1 to AGND	−0.3 V to +6 V
VIN2 to VIN1	−0.3 V to +0.3 V
PGND1, PGND2 to AGND	−0.3 V to +0.3 V
VIN3, VIN4, VOUT1, VOUT2, ENA, ENB, MODE to AGND	−0.3 V to (VIN1 + 0.3 V)
VOUT3 to AGND	−0.3 V to (VIN3 + 0.3 V)
VOUT4 to AGND	−0.3 V to (VIN4 + 0.3 V)
SW1 to PGND1	−0.3 V to (VIN1 + 0.3 V)
SW2 to PGND2	−0.3 V to (VIN2 + 0.3 V)
Storage Temperature Range	−65°C to +150°C
Operating Junction Temperature Range	−40°C to +125°C
Soldering Conditions	JEDEC J-STD-020

Stresses at or above those listed under Absolute Maximum Ratings may cause permanent damage to the product. This is a stress rating only; functional operation of the product at these or any other conditions above those indicated in the operational section of this specification is not implied. Operation beyond the maximum operating conditions for extended periods may affect product reliability.

For detailed information on power dissipation, see the Power Dissipation and Thermal Considerations section.

## THERMAL RESISTANCE

$\theta_{JA}$  and  $\Psi_{JB}$  are specified for the worst-case conditions, that is, a device soldered in a circuit board for surface-mount packages.

Table 7. Thermal Resistance

Package Type	$\theta_{JA}$	$\Psi_{JB}$	Unit
16-Ball, 0.5 mm Pitch WLCSP	57	14	°C/W

## ESD CAUTION



**ESD (electrostatic discharge) sensitive device.** Charged devices and circuit boards can discharge without detection. Although this product features patented or proprietary protection circuitry, damage may occur on devices subjected to high energy ESD. Therefore, proper ESD precautions should be taken to avoid performance degradation or loss of functionality.

## PIN CONFIGURATION AND FUNCTION DESCRIPTIONS

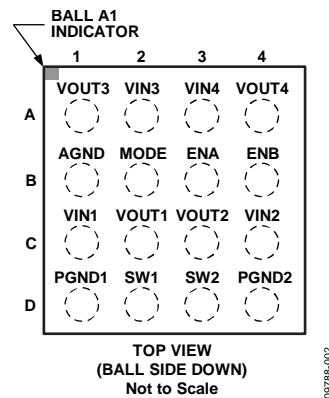

Figure 2. Pin Configuration—View from the Top of the Die

Table 8. Pin Function Descriptions

Pin No.	Mnemonic	Description
A1	VOUT3	LDO1 Output Voltage and Sensing Input.
A2	VIN3	LDO1 Input Supply (1.7 V to 5.5 V, $VIN4 \leq VIN1 = VIN2$ ).
A3	VIN4	LDO2 Input Supply (1.7 V to 5.5 V, $VIN3 \leq VIN1 = VIN2$ ).
A3	VOUT4	LDO2 Output Voltage and Sensing Input.
B1	AGND	Analog Ground.
B2	MODE	BUCK1/BUCK2 Operating Mode. MODE = high: forced PWM operation. MODE = low: auto PWM/PSM operation.
B3	ENA	Regulator Enable Pin A, Active High. The regulators turned on with ENA are factory programmed.
B4	ENB	Regulator Enable Pin B, Active High. The regulators turned on with ENB are factory programmed.
C1	VIN1	BUCK1 Input Supply (2.3 V to 5.5 V) and UVLO Detection. Connect VIN1 to VIN2.
C2	VOUT1	BUCK1 Output Voltage Sensing Input.
C3	VOUT2	BUCK2 Output Voltage Sensing Input.
C4	VIN2	BUCK2 Input Supply (2.3 V to 5.5 V). Connect VIN2 to VIN1.
D1	PGND1	Dedicated Power Ground for BUCK1.
D2	SW1	BUCK1 Switching Node.
D3	SW2	BUCK2 Switching Node.
D4	PGND2	Dedicated Power Ground for BUCK2.

# TYPICAL PERFORMANCE CHARACTERISTICS

$V_{IN1} = V_{IN2} = V_{IN3} = V_{IN4} = 3.6\text{ V}$ ,  $T_A = 25^\circ\text{C}$ , unless otherwise noted.

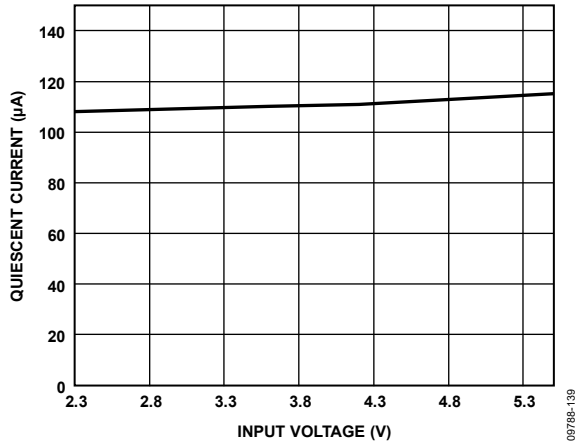

Figure 3. System Quiescent Current vs. Input Voltage,  $V_{OUT1} = 3.3\text{ V}$ ,  $V_{OUT2} = 1.8\text{ V}$ ,  $V_{OUT3} = 1.2\text{ V}$ ,  $V_{OUT4} = 3.3\text{ V}$ , All Channels Unloaded

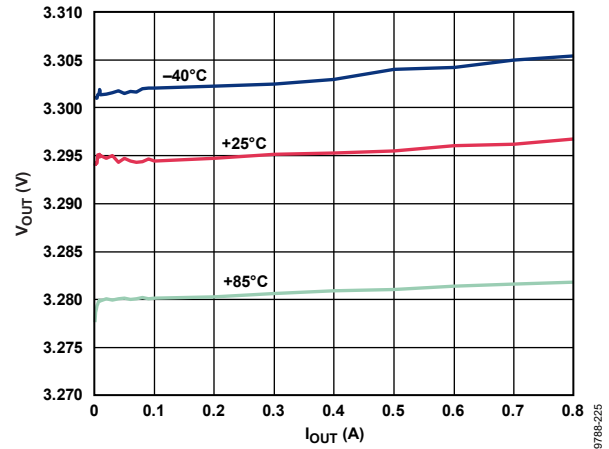

Figure 6. BUCK1 Load Regulation Across Temperature,  $V_{IN} = 4.2\text{ V}$ ,  $V_{OUT1} = 3.3\text{ V}$ , PWM Mode

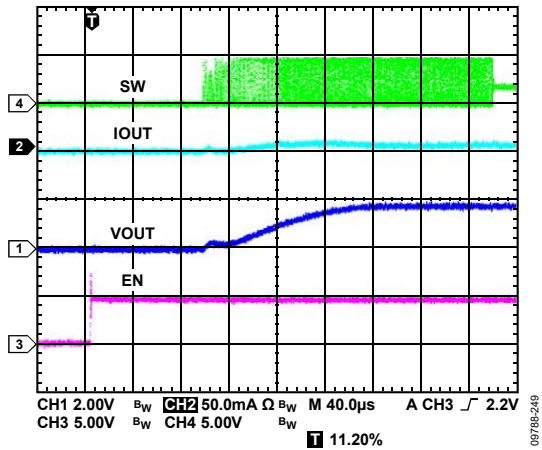

Figure 4. Buck1 Startup,  $V_{OUT1} = 1.8\text{ V}$ ,  $I_{OUT1} = 5\text{ mA}$

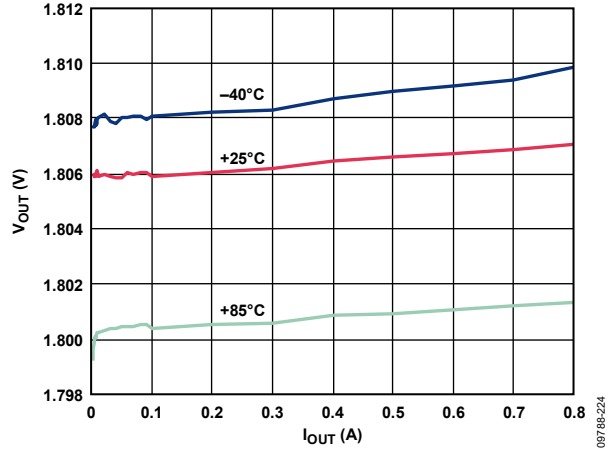

Figure 7. BUCK2 Load Regulation Across Temperature,  $V_{IN} = 3.6\text{ V}$ ,  $V_{OUT2} = 1.8\text{ V}$ , PWM Mode

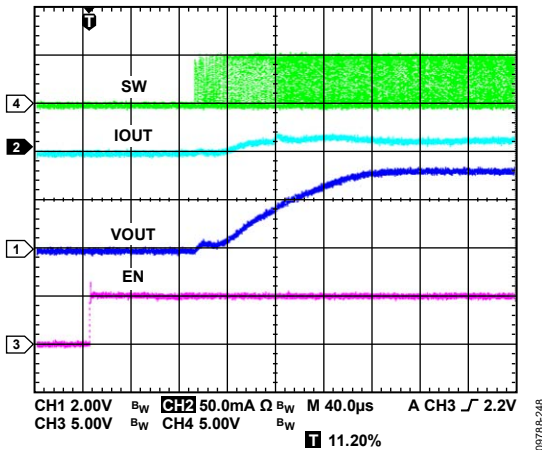

Figure 5. BUCK2 Startup,  $V_{OUT2} = 3.3\text{ V}$ ,  $I_{OUT2} = 10\text{ mA}$

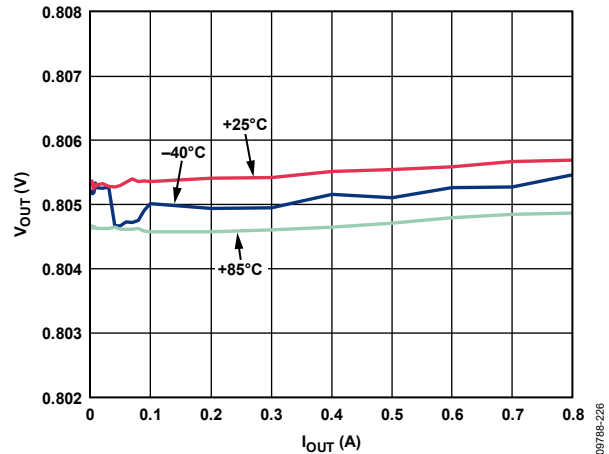

Figure 8. BUCK1 Load Regulation Across Temperature,  $V_{IN} = 3.6\text{ V}$ ,  $V_{OUT1} = 0.8\text{ V}$ , PWM Mode



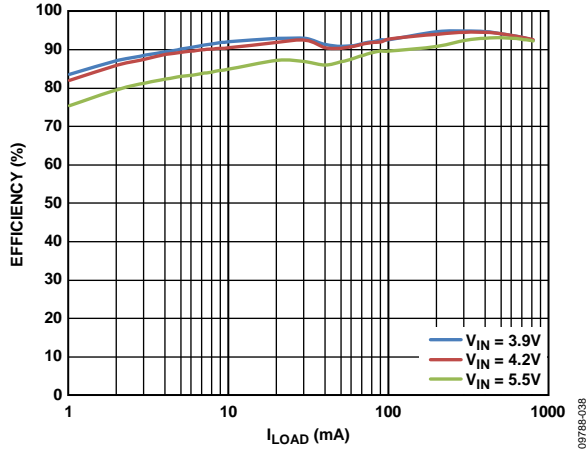

Figure 9. BUCK1 Efficiency vs. Load Current, Across Input Voltage,  $V_{OUT1} = 3.3\text{ V}$ , Auto Mode

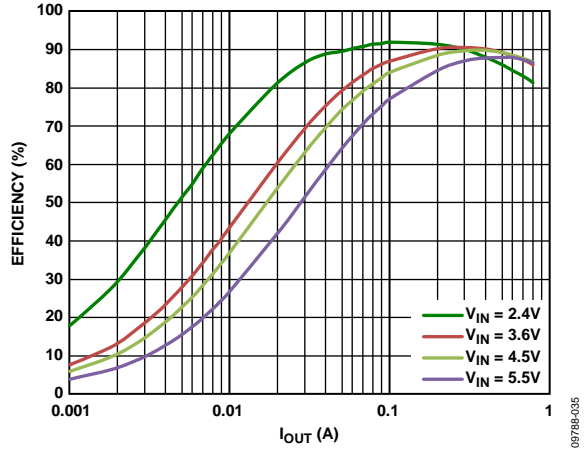

Figure 12. BUCK2 Efficiency vs. Load Current, Across Input Voltage,  $V_{OUT2} = 1.8\text{ V}$ , PWM Mode

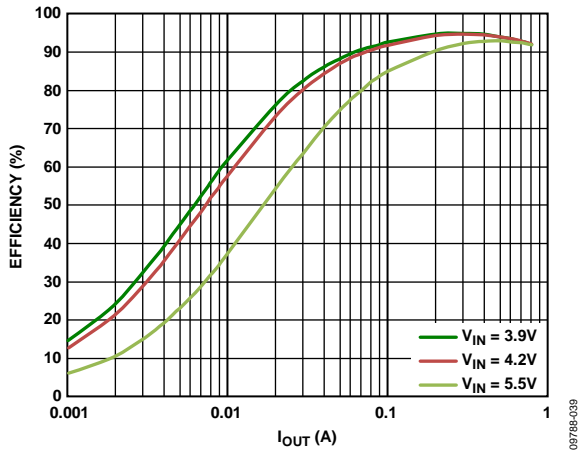

Figure 10. BUCK1 Efficiency vs. Load Current, Across Input Voltage,  $V_{OUT1} = 3.3\text{ V}$ , PWM Mode

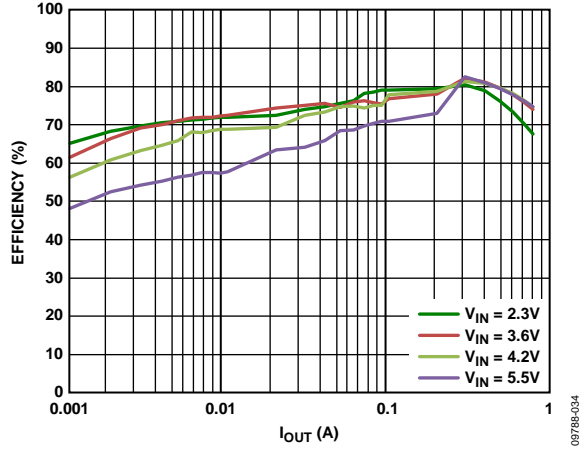

Figure 13. BUCK1 Efficiency vs. Load Current, Across Input Voltage,  $V_{OUT1} = 0.8\text{ V}$ , Auto Mode

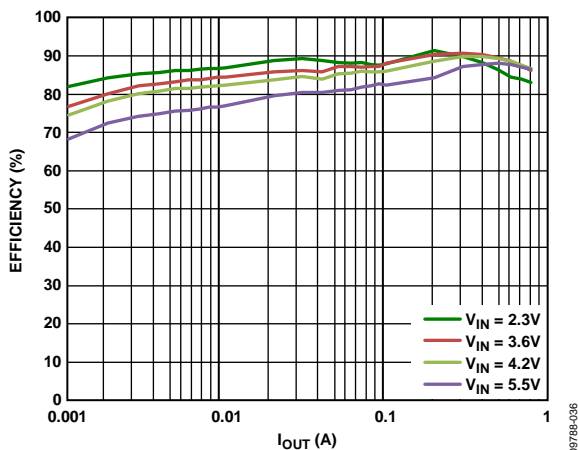

Figure 11. BUCK2 Efficiency vs. Load Current, Across Input Voltage,  $V_{OUT2} = 1.8\text{ V}$ , Auto Mode

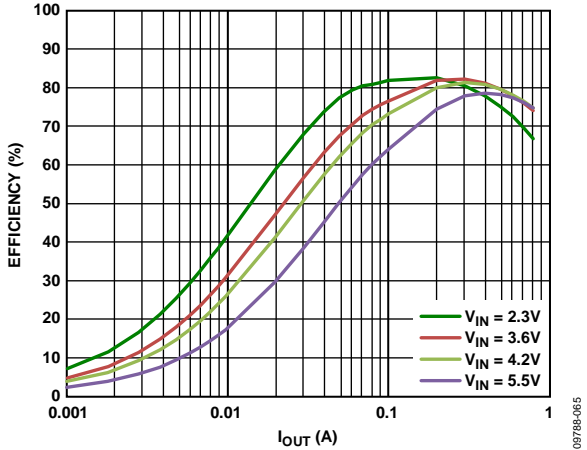

Figure 14. BUCK1 Efficiency vs. Load Current, Across Input Voltage,  $V_{OUT1} = 0.8\text{ V}$ , PWM Mode

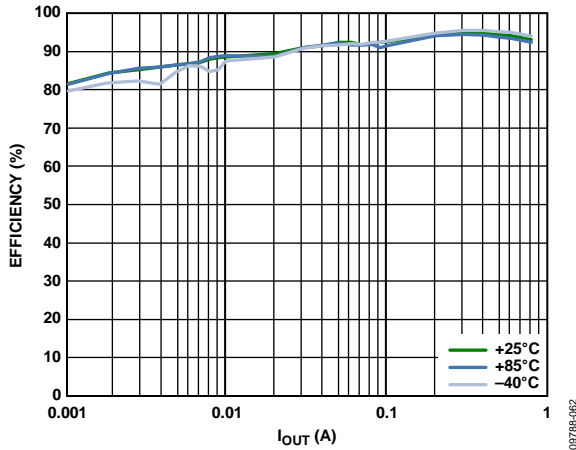

Figure 15. BUCK1 Efficiency vs. Load Current, Across Temperature,  $V_{IN1} = 3.9\text{ V}$ ,  $V_{OUT1} = 3.3\text{ V}$ , Auto Mode

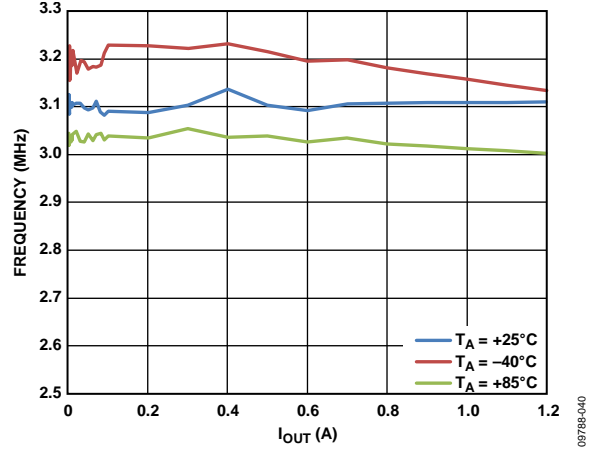

Figure 18. BUCK2 Switching Frequency vs. Output Current, Across Temperature,  $V_{OUT2} = 1.8\text{ V}$ , PWM Mode

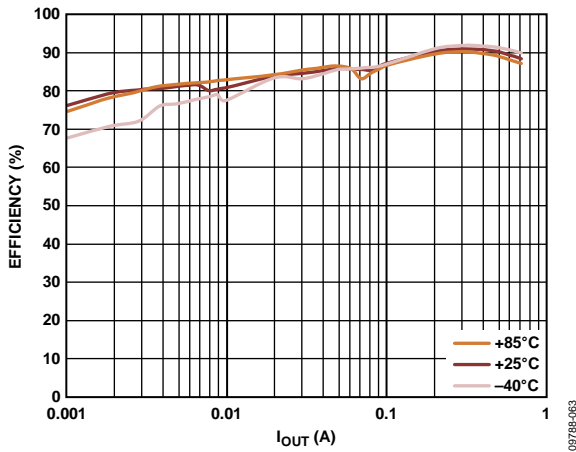

Figure 16. BUCK2 Efficiency vs. Load Current, Across Temperature,  $V_{OUT2} = 1.8\text{ V}$ , Auto Mode

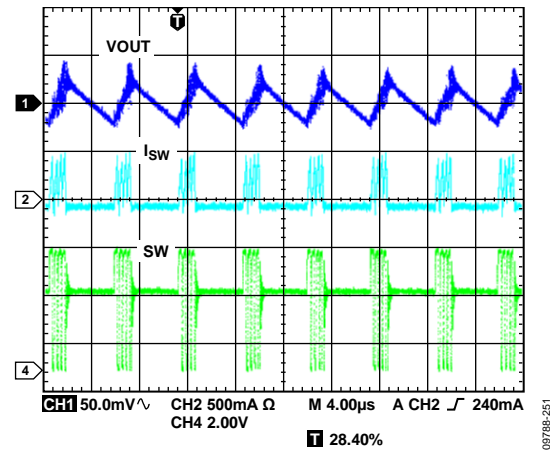

Figure 19. Typical Waveforms,  $V_{OUT1} = 3.3\text{ V}$ ,  $I_{OUT1} = 30\text{ mA}$ , Auto Mode

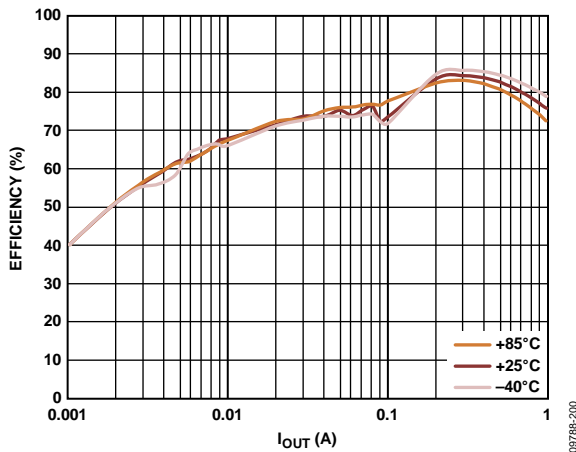

Figure 17. BUCK1 Efficiency vs. Load Current, Across Temperature,  $V_{OUT1} = 0.8\text{ V}$ , Auto Mode

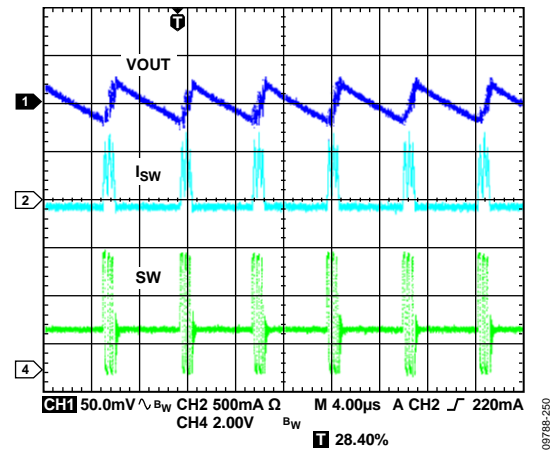

Figure 20. Typical Waveforms,  $V_{OUT2} = 1.8\text{ V}$ ,  $I_{OUT2} = 30\text{ mA}$ , Auto Mode

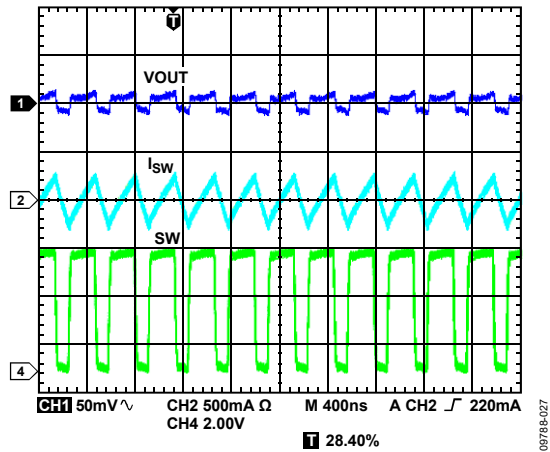

Figure 21. Typical Waveforms,  $V_{OUT1} = 3.3\text{ V}$ ,  $I_{OUT1} = 30\text{ mA}$ , PWM Mode

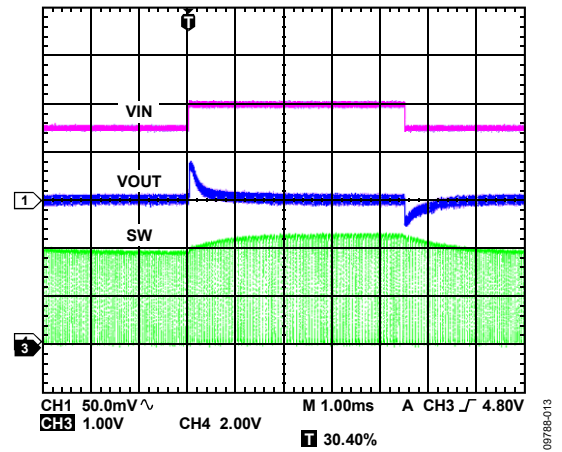

Figure 24. BUCK2 Response to Line Transient,  $V_{IN} = 4.5\text{ V}$  to  $5.0\text{ V}$ ,  $V_{OUT2} = 1.8\text{ V}$ , PWM Mode

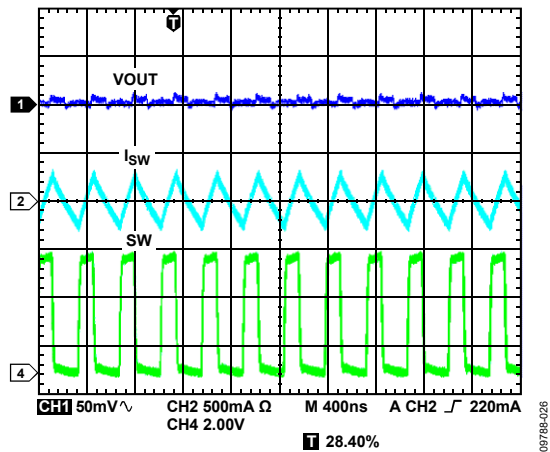

Figure 22. Typical Waveforms,  $V_{OUT2} = 1.8\text{ V}$ ,  $I_{OUT2} = 30\text{ mA}$ , PWM Mode

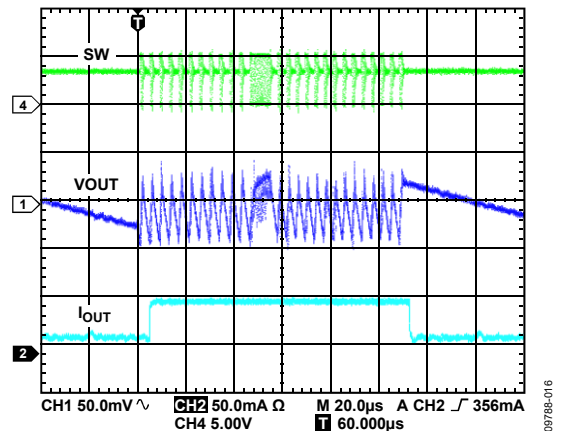

Figure 25. BUCK1 Response to Load Transient,  $I_{OUT1}$  from  $1\text{ mA}$  to  $50\text{ mA}$ ,  $V_{OUT1} = 3.3\text{ V}$ , Auto Mode

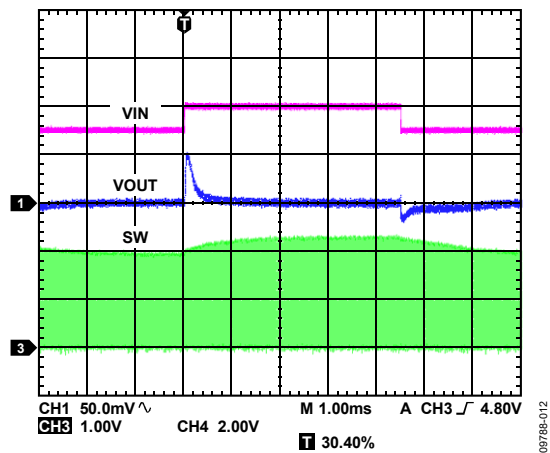

Figure 23. Buck1 Response to Line Transient, Input Voltage from  $4.5\text{ V}$  to  $5.0\text{ V}$ ,  $V_{OUT1} = 3.3\text{ V}$ , PWM Mode

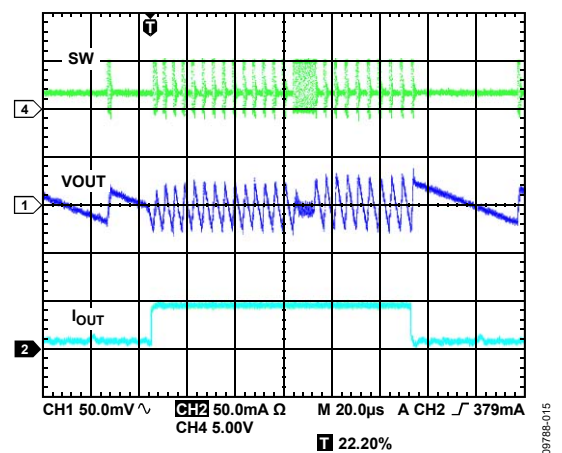

Figure 26. BUCK2 Response to Load Transient,  $I_{OUT2}$  from  $1\text{ mA}$  to  $50\text{ mA}$ ,  $V_{OUT2} = 1.8\text{ V}$ , Auto Mode

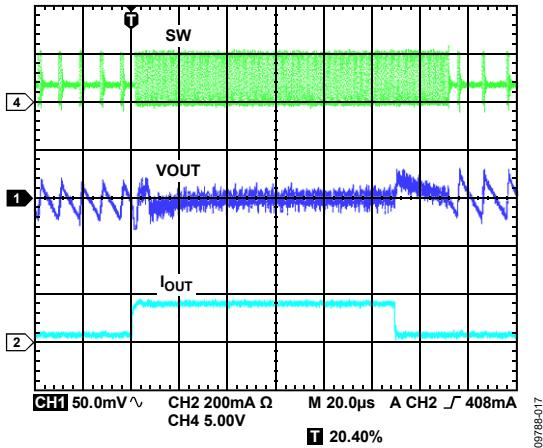

Figure 27. BUCK1 Response to Load Transient,  $I_{OUT1}$  from 20 mA to 180 mA,  $V_{OUT1} = 3.3$  V, Auto Mode

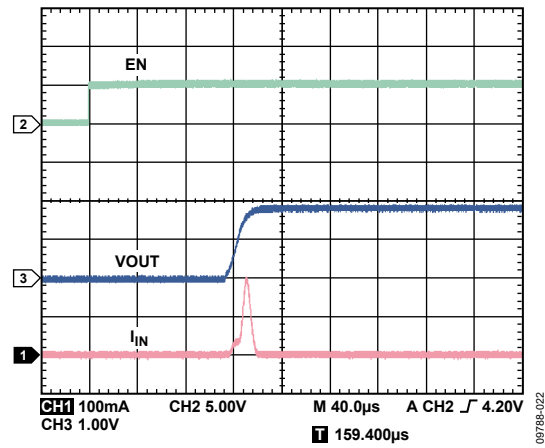

Figure 30. LDO Startup,  $V_{OUT3} = 1.8$  V

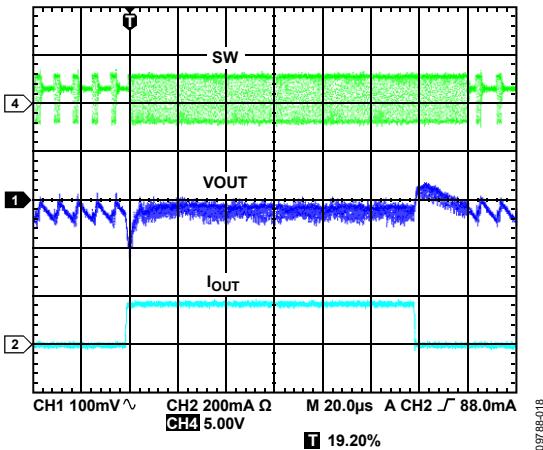

Figure 28. BUCK2 Response to Load Transient,  $I_{OUT2}$  from 20 mA to 180 mA,  $V_{OUT2} = 1.8$  V, Auto Mode

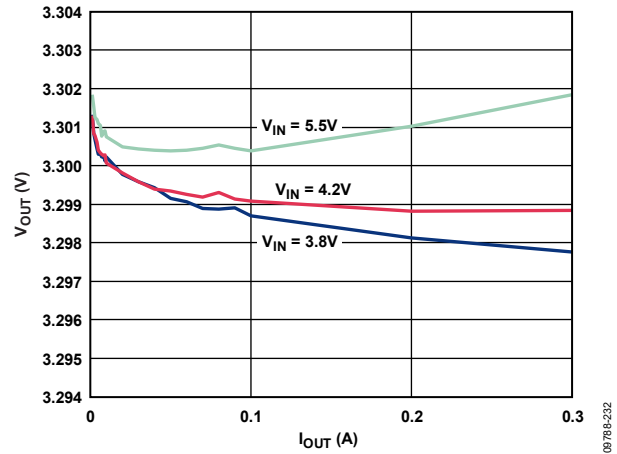

Figure 31. LDO Load Regulation Across Input Voltage,  $V_{OUT3} = 3.3$  V

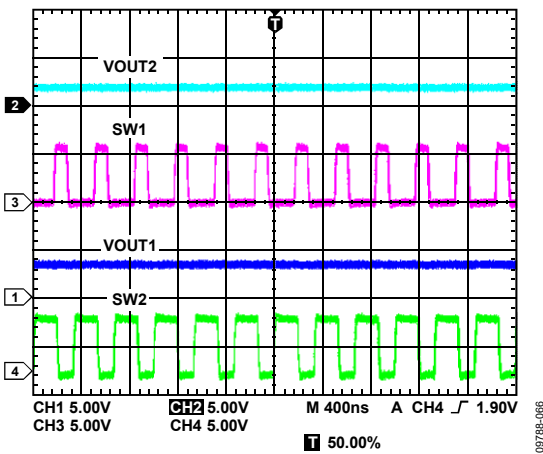

Figure 29. VOUT and SW Waveforms for BUCK1 and BUCK2 in PWM Mode Showing Out-of-Phase Operation

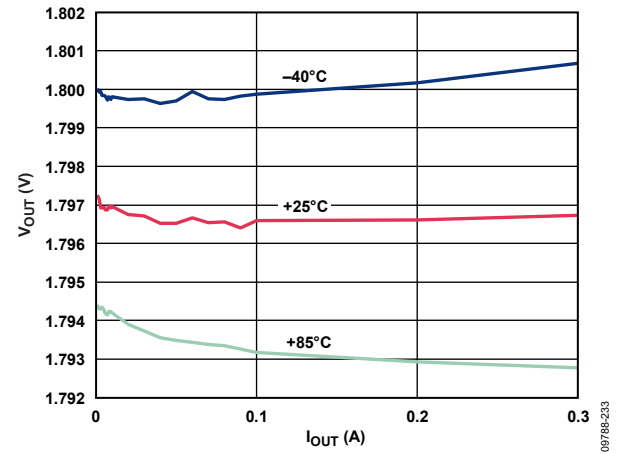

Figure 32. LDO Load Regulation Across Temperature,  $V_{IN3} = 3.6$  V,  $V_{OUT3} = 1.8$  V

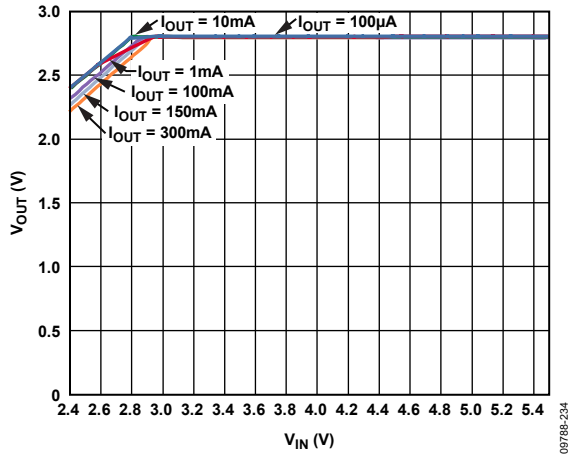

Figure 33. LDO Line Regulation Across Output Load,  $V_{OUT3} = 2.8\text{ V}$

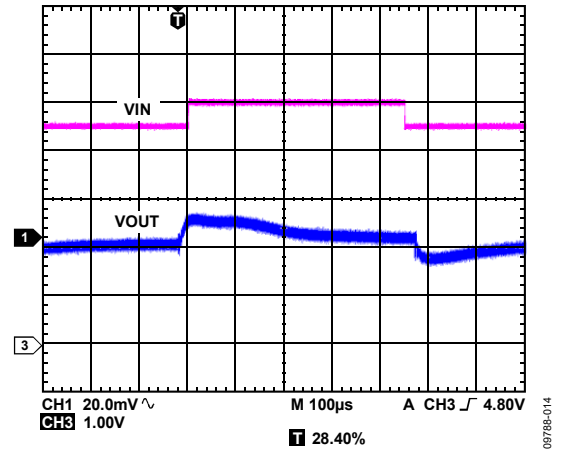

Figure 36. LDO Response to Line Transient, Input Voltage from 4.5 V to 5 V,  $V_{OUT3} = 2.8\text{ V}$

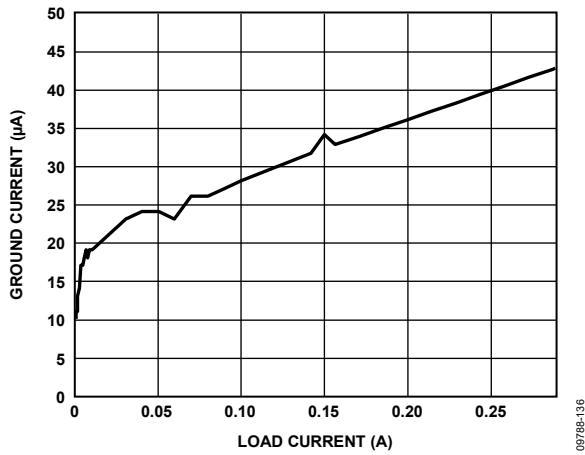

Figure 34. LDO Ground Current vs. Output Load,  $V_{IN3} = 3.3\text{ V}$ ,  $V_{OUT3} = 2.8\text{ V}$

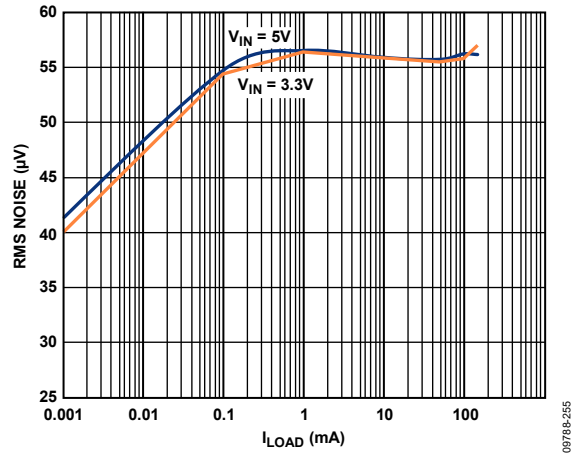

Figure 37. LDO Output Noise vs. Load Current, Across Input Voltage,  $V_{OUT3} = 2.8\text{ V}$

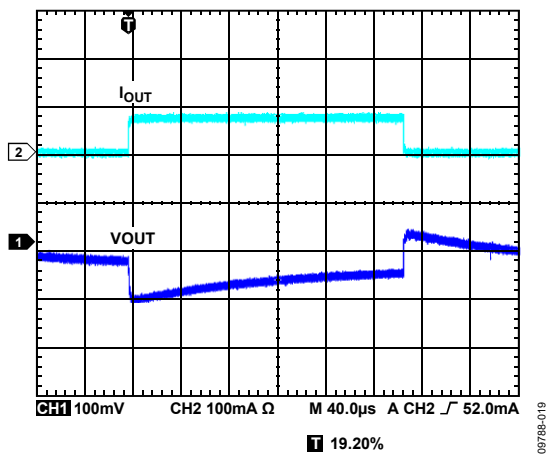

Figure 35. LDO Response to Load Transient,  $I_{OUT3}$  from 1 mA to 80 mA,  $V_{OUT3} = 2.8\text{ V}$

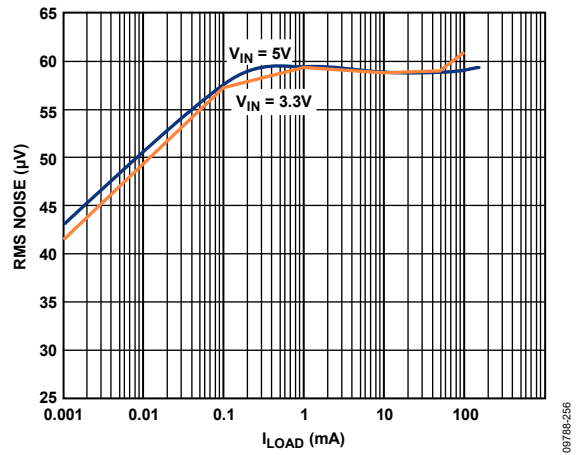

Figure 38. LDO Output Noise vs. Load Current, Across Input Voltage,  $V_{OUT3} = 3.0\text{ V}$

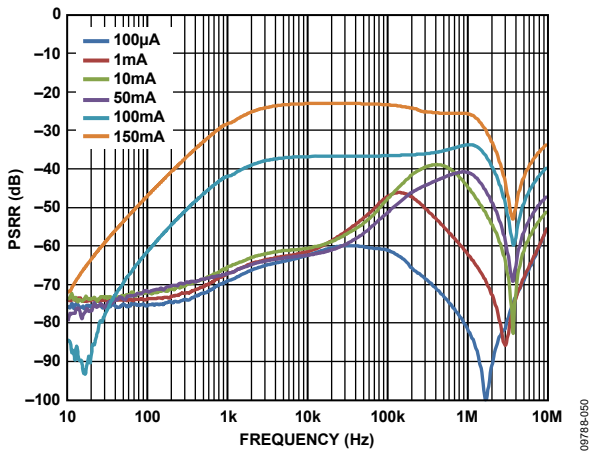

Figure 39. LDO PSRR Across Output Load,  $V_{IN3} = 3.3\text{ V}$ ,  $V_{OUT3} = 2.8\text{ V}$

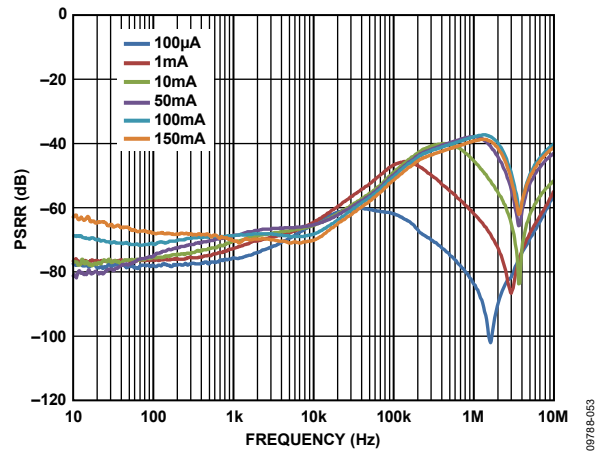

Figure 41. LDO PSRR Across Output Load,  $V_{IN3} = 5.0\text{ V}$ ,  $V_{OUT3} = 2.8\text{ V}$

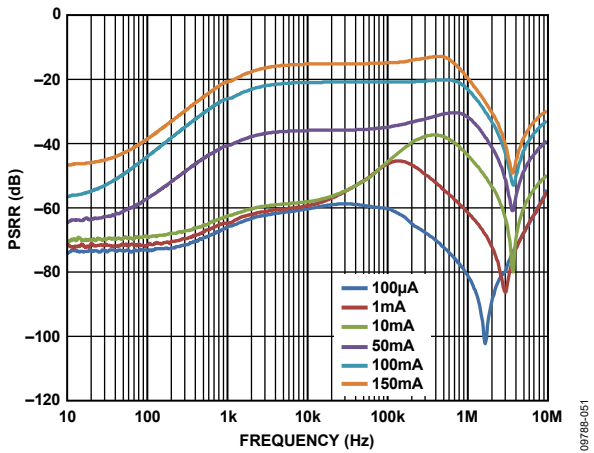

Figure 40. LDO PSRR Across Output Load,  $V_{IN3} = 3.3\text{ V}$ ,  $V_{OUT3} = 3.0\text{ V}$

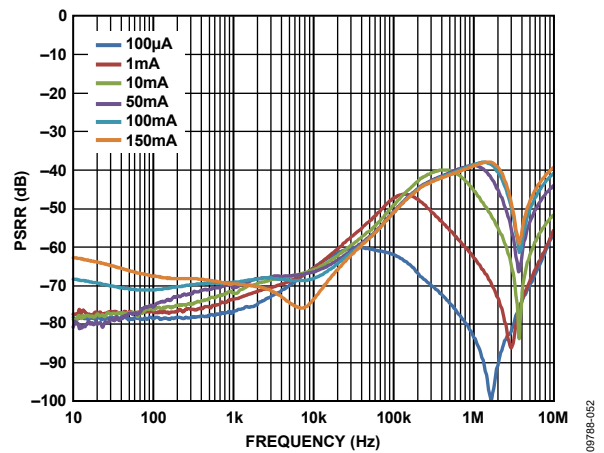

Figure 42. LDO PSRR Across Output Load,  $V_{IN3} = 5.0\text{ V}$ ,  $V_{OUT3} = 3.0\text{ V}$

## THEORY OF OPERATION

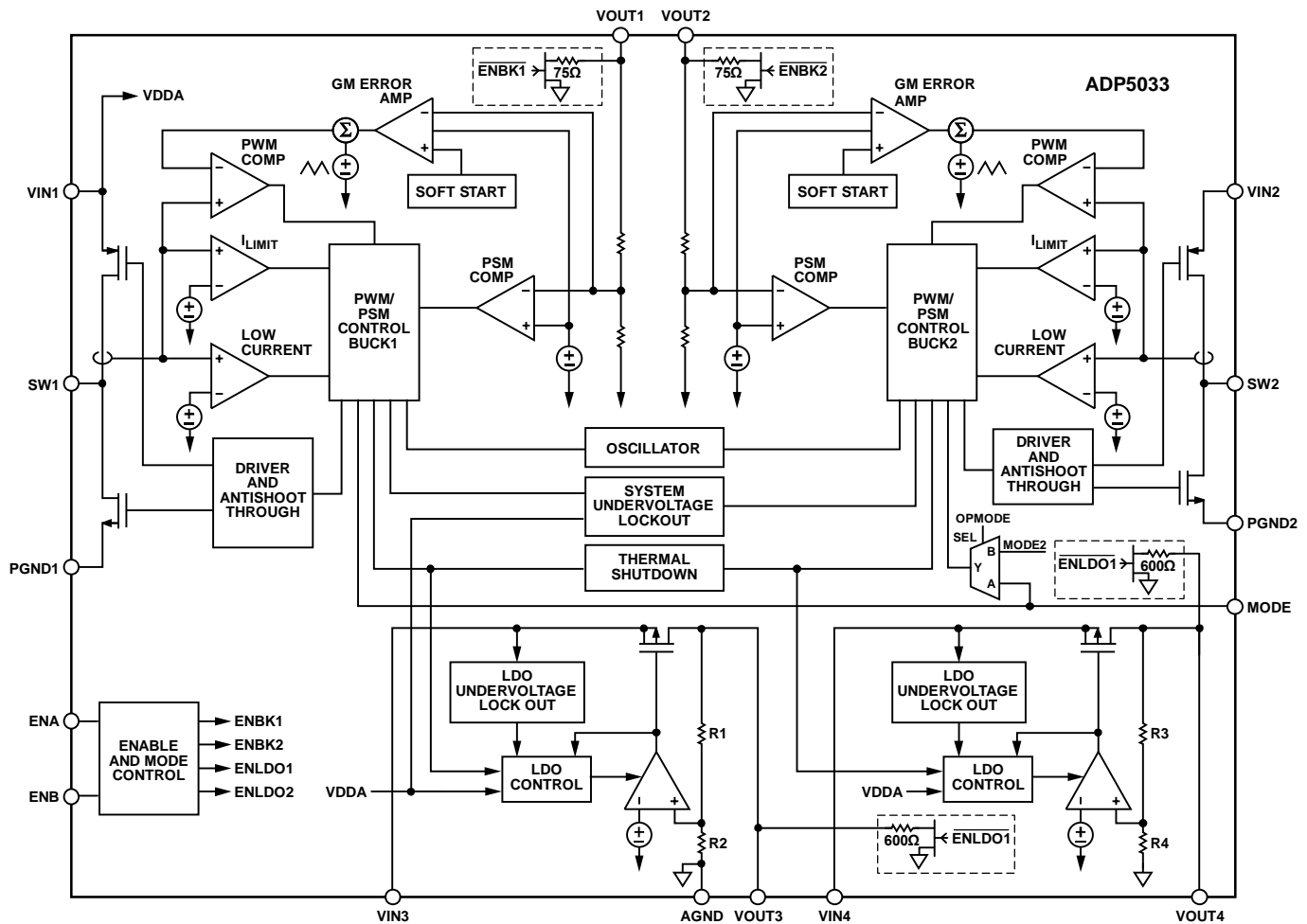

Figure 43. Functional Block Diagram

## POWER MANAGEMENT UNIT

The ADP5033 is a micropower management unit ( $\mu$ PMU) combining two step-down (buck) dc-to-dc converters and two low dropout linear regulators (LDO). The high switching frequency and tiny 16-ball WLCSP package allow for a small power management solution.

To combine these high performance regulators into the  $\mu$ PMU, there is a system controller allowing them to operate together.

The buck regulators can operate in forced PWM mode if the MODE pin is at a logic high level. In forced PWM mode, the buck switching frequency is always constant and does not change with the load current. If the MODE pin is at logic low, the switching regulators operate in auto PWM/PSM mode. In this mode, the regulators operate at fixed PWM frequency when the load current is above the power saving current threshold. When the load current falls below the power save current threshold, the regulator in question enters PSM where the switching occurs in bursts. The burst repetition is a function of the current load and the output capacitor value. This operating mode reduces the switching and quiescent current losses.

The auto PWM/PSM mode transition is controlled independently for each buck regulator. The two bucks operate synchronized to each other.

When a regulator is turned on, the output voltage ramp is controlled through a soft start circuit to avoid a large inrush current due to the charging of the output capacitors.

**Thermal Protection**

In the event that the junction temperature rises above 150°C, the thermal shutdown circuit turns off all the regulators. Extreme junction temperatures can be the result of high current operation, poor circuit board design, or high ambient temperature. A 20°C hysteresis is included so that when thermal shutdown occurs, the regulators do not return to operation until the on-chip temperature drops below 130°C. When coming out of thermal shutdown, all regulators restart with soft start control.

### Undervoltage Lockout

To protect against battery discharge, undervoltage lockout (UVLO) circuitry is integrated in the system. If the input voltage on VIN1 drops below a typical 2.15 V UVLO threshold, all channels shut down. In the buck channels, both the power switch and the synchronous rectifier turn off. When the voltage on VIN1 rises above the UVLO threshold, the part is enabled once more.

Alternatively, the user can request a new device model with a UVLO set at a higher level, suitable for 5 V supply applications. For these models, the device reaches the turn-off threshold when the input supply drops to 3.65 V typical. To order a device with options other than the default options listed in the Ordering Guide section, contact your local Analog Devices, Inc., sales or distribution representative.

In case of a thermal or UVLO event, the active pull-down resistors (if factory enabled) are enabled to discharge the output capacitors quickly. The pull-down resistors remain engaged until the thermal fault event is no longer present or the input supply voltage falls below the  $V_{POR}$  voltage level. The typical value of  $V_{POR}$  is approximately 1 V.

### Enable/Shutdown

The ADP5033 has two enable pins (ENA and ENB). A high level applied to the enable pins enables a certain selection of regulators defined by factory programming. For example, the ADP5033 can be factory programmed to enable BUCK1 and LDO2 with ENA and BUCK2 and LDO1 with ENB. When both enables are low, all regulators are turned off. When both enable pins are high, all regulators are turned on. All possible regulator combinations can be factory programmed to operate with the ENA and ENB pins.

Figure 44 shows the regulator activation timings for the ADP5033 when both enables are connected to VINx. Figure 44 also shows the active pull-down activation.

### BUCK1 AND BUCK2

The two bucks use a fixed frequency and high speed current mode architecture. The bucks operate with an input voltage of 2.3 V to 5.5 V.

### Control Scheme

The bucks operate with a fixed frequency, current mode PWM control architecture at medium to high loads for high efficiency but shift to a PSM control scheme at light loads to lower the regulation power losses. When operating in fixed frequency PWM mode, the duty cycle of the integrated switches is adjusted and regulates the output voltage. When operating in PSM at light loads, the output voltage is controlled in a hysteretic manner, with higher output voltage ripple. During part of this time, the converter is able to stop switching and enters an idle mode, which improves conversion efficiency.

### PWM Mode

In PWM mode, the bucks operate at a fixed frequency of 3 MHz set by an internal oscillator. At the start of each oscillator cycle, the PFET switch is turned on, sending a positive voltage across the inductor. Current in the inductor increases until the current sense signal crosses the peak inductor current threshold that turns off the PFET switch and turns on the NFET synchronous rectifier. This sends a negative voltage across the inductor, causing the inductor current to decrease. The synchronous rectifier stays on for the rest of the cycle. The buck regulates the output voltage by adjusting the peak inductor current threshold.

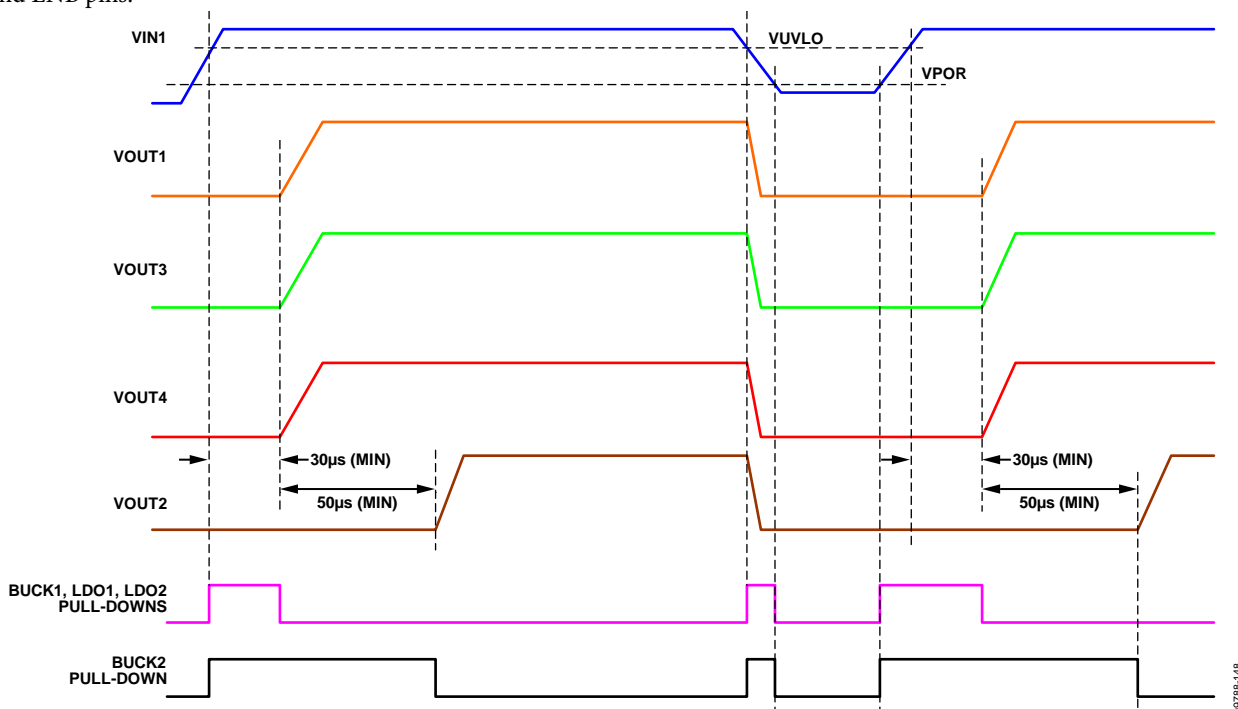

Figure 44. Regulators Sequencing on the ADP5033 ( $ENx = VINx$ )



### **PSM**

The bucks smoothly transition to PSM operation when the load current decreases below the PSM current threshold. When either of the bucks enters PSM, an offset is induced in the PWM regulation level, which makes the output voltage rise. When the output voltage reaches a level approximately 1.5% above the PWM regulation level, PWM operation is turned off. At this point, both power switches are off, and the buck enters an idle mode. The output capacitor discharges until the output voltage falls to the PWM regulation voltage, at which point the device drives the inductor to make the output voltage rise again to the upper threshold. This process is repeated while the load current is below the PSM current threshold.

The ADP5033 has a dedicated MODE pin controlling the PSM and PWM operation. A high logic level applied to the MODE pin forces both bucks to operate in PWM mode. A logic level low sets the bucks to operate in auto PSM/PWM.

### **PSM Current Threshold**

The PSM current threshold is set to 100 mA. The bucks employ a scheme that enables this current to remain accurately controlled, independent of input and output voltage levels. This scheme also ensures that there is very little hysteresis between the PSM current threshold for entry to and exit from the PSM. The PSM current threshold is optimized for excellent efficiency over all load currents.

### **Oscillator/Phasing of Inductor Switching**

The ADP5033 ensures that both bucks operate at the same switching frequency when both bucks are in PWM mode.

Additionally, the ADP5033 ensures that when both bucks are in PWM mode, they operate out of phase, whereby the BUCK2 PFET starts conducting exactly half a clock period after the BUCK1 PFET starts conducting.

### **Short-Circuit Protection**

The bucks include frequency foldback to prevent output current runaway on a hard short. When the voltage at the feedback pin falls below half the target output voltage, indicating the possibility of a hard short at the output, the switching frequency is reduced to half the internal oscillator frequency. The reduction in the switching frequency allows more time for the inductor to discharge, preventing a runaway of output current.

### **Soft Start**

The bucks have an internal soft start function that ramps the output voltage in a controlled manner upon startup, thereby limiting the inrush current. This prevents possible input voltage drops when a battery or a high impedance power source is connected to the input of the converter.

### **Current Limit**

Each buck has protection circuitry to limit the amount of positive current flowing through the PFET switch and the amount of negative current flowing through the synchronous rectifier. The positive current limit on the power switch limits the amount of current that can flow from the input to the output. The negative current limit prevents the inductor current from reversing direction and flowing out of the load.

### **100% Duty Operation**

With a drop in input voltage or with an increase in load current, the buck may reach a limit where, even with the PFET switch on 100% of the time, the output voltage drops below the desired output voltage. At this limit, the buck transitions to a mode where the PFET switch stays on 100% of the time. When the input conditions change again and the required duty cycle falls, the buck immediately restarts PWM regulation without allowing overshoot on the output voltage.

### **Active Pull-Downs**

All regulators have optional, factory programmable, active pull-down resistors discharging the respective output capacitors when the regulators are disabled by the ENx pins or by a faulty condition. The pull-down resistors are connected between VOUTx and AGND. Active pull-downs are disabled when the regulators are turned on. The typical value of the pull-down resistor is 600  $\Omega$  for the LDOs and 75  $\Omega$  for the bucks. Figure 44 shows the activation timings for the active pull-down during regulator activation and deactivation.

### **LDO1 AND LDO2**

The ADP5033 contains two LDOs with low quiescent current and low dropout voltage, and provides up to 300 mA of output current. Drawing a low 25  $\mu$ A quiescent current (typical) at no load makes the LDO ideal for battery-operated portable equipment.

Each LDO operates with an input voltage of 1.7 V to 5.5 V. The wide operating range makes these LDOs suitable for cascading configurations where the LDO supply voltage is provided from one of the buck regulators.

Each LDO also provides high power supply rejection ratio (PSRR), low output noise, and excellent line and load transient response with just a small 1  $\mu$ F ceramic input and output capacitor.

LDO1 is optimized to supply analog circuits because it offers better noise performance compared to LDO2. LDO1 should be used in applications where noise performance is critical.

## APPLICATIONS INFORMATION

### BUCK EXTERNAL COMPONENT SELECTION

Trade-offs between performance parameters such as efficiency and transient response can be made by varying the choice of external components in the applications circuit, as shown in Figure 1.

#### Inductor

The high switching frequency of the ADP5033 bucks allows for the selection of small chip inductors. For best performance, use inductor values between 0.7  $\mu\text{H}$  and 3  $\mu\text{H}$ . Suggested inductors are shown in Table 9.

The peak-to-peak inductor current ripple is calculated using the following equation:

$$I_{\text{RIPPLE}} = \frac{V_{\text{OUT}} \times (V_{\text{IN}} - V_{\text{OUT}})}{V_{\text{IN}} \times f_{\text{SW}} \times L}$$

where:

$f_{\text{SW}}$  is the switching frequency.

$L$  is the inductor value.

The minimum dc current rating of the inductor must be greater than the inductor peak current. The inductor peak current is calculated using the following equation:

$$I_{\text{PEAK}} = I_{\text{LOAD(MAX)}} + \frac{I_{\text{RIPPLE}}}{2}$$

Inductor conduction losses are caused by the flow of current through the inductor, which has an associated internal dc resistance (DCR). Larger sized inductors have smaller DCR, which may decrease inductor conduction losses. Inductor core losses are related to the magnetic permeability of the core material. Because the bucks are high switching frequency dc-to-dc converters, shielded ferrite core material is recommended for its low core losses and low EMI.

**Table 9. Suggested 1.0  $\mu\text{H}$  Inductors**

Vendor	Model	Dimensions (mm)	$I_{\text{SAT}}$ (mA)	DCR (m $\Omega$ )
Murata	LQM2MPN1R0NG0B	2.0 $\times$ 1.6 $\times$ 0.9	1400	85
Murata	LQM18FN1R0M00B	1.6 $\times$ 0.8 $\times$ 0.8	150	26
Taiyo Yuden	BRC1608T1R0M	1.6 $\times$ 0.8 $\times$ 0.8	520	180
Coilcraft	EPL2014-102ML	2.0 $\times$ 2.0 $\times$ 1.4	900	59
TDK	GLFR1608T1R0M-LR	1.6 $\times$ 0.8 $\times$ 0.8	230	80
Coilcraft	0603LS-102	1.8 $\times$ 1.69 $\times$ 1.1	400	81
Toko	MDT2520-CN	2.5 $\times$ 2.0 $\times$ 1.2	1350	85

#### Output Capacitor

Higher output capacitor values reduce the output voltage ripple and improve load transient response. When choosing this value, it is also important to account for the loss of capacitance due to output voltage dc bias.

Ceramic capacitors are manufactured with a variety of dielectrics, each with a different behavior over temperature and applied voltage. Capacitors must have a dielectric adequate to ensure the minimum capacitance over the necessary temperature range and dc bias conditions. X5R or X7R dielectrics with a voltage rating of 6.3 V or 10 V are recommended for best performance. Y5V and Z5U dielectrics are not recommended for use with any dc-to-dc converter because of their poor temperature and dc bias characteristics.

The worst-case capacitance accounting for capacitor variation over temperature, component tolerance, and voltage is calculated using the following equation:

$$C_{\text{EFF}} = C_{\text{OUT}} \times (1 - \text{TEMPCO}) \times (1 - \text{TOL})$$

where:

$C_{\text{EFF}}$  is the effective capacitance at the operating voltage.

$\text{TEMPCO}$  is the worst-case capacitor temperature coefficient.

$\text{TOL}$  is the worst-case component tolerance.

In this example, the worst-case temperature coefficient ( $\text{TEMPCO}$ ) over  $-40^\circ\text{C}$  to  $+85^\circ\text{C}$  is assumed to be 15% for an X5R dielectric. The tolerance of the capacitor ( $\text{TOL}$ ) is assumed to be 10%, and  $C_{\text{OUT}}$  is 9.2  $\mu\text{F}$  at 1.8 V, as shown in Figure 45.

Substituting these values in the equation yields

$$C_{\text{EFF}} = 9.2 \mu\text{F} \times (1 - 0.15) \times (1 - 0.1) \approx 7.0 \mu\text{F}$$

To guarantee the performance of the bucks, it is imperative that the effects of dc bias, temperature, and tolerances on the behavior of the capacitors be evaluated for each application.

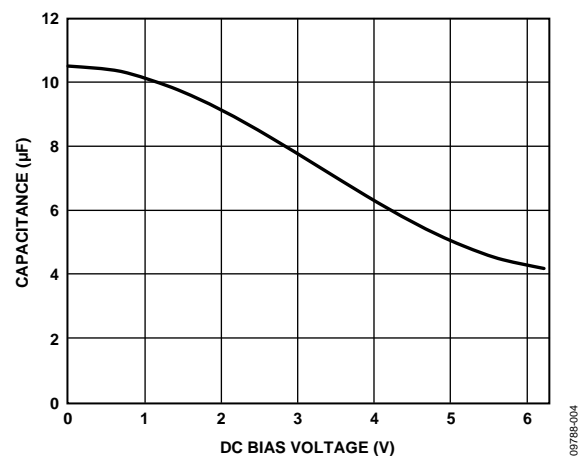

Figure 45. Typical Capacitor Performance

The peak-to-peak output voltage ripple for the selected output capacitor and inductor values is calculated using the following equation:

$$V_{RIPPLE} = \frac{I_{RIPPLE}}{8 \times f_{SW} \times C_{OUT}} \approx \frac{V_{IN}}{(2\pi \times f_{SW})^2 \times L \times C_{OUT}}$$

Capacitors with lower equivalent series resistance (ESR) are preferred to guarantee low output voltage ripple, as shown in the following equation:

$$ESR_{COUT} \leq \frac{V_{RIPPLE}}{I_{RIPPLE}}$$

The effective capacitance needed for stability, which includes temperature and dc bias effects, is a minimum of 7  $\mu\text{F}$  and a maximum of 40  $\mu\text{F}$ .

The buck regulators require 10  $\mu\text{F}$  output capacitors to guarantee stability and response to rapid load variations and to transition into and out of the PWM/PSM modes. In certain applications, where one or both buck regulators power a processor, the operating state is known because it is controlled by software. In this condition, the processor can drive the MODE pin according to the operating state; consequently, it is possible to reduce the output capacitor from 10  $\mu\text{F}$  to 4.7  $\mu\text{F}$  because the regulator does not expect a large load variation when working in PSM mode (see Figure 47).

**Table 10. Suggested 10  $\mu\text{F}$  Capacitors**

Vendor	Type	Model	Case Size	Voltage Rating (V)
Murata	X5R	GRM188R60J106	0603	6.3
TDK	X5R	C1608JB0J106K	0603	6.3
Panasonic	X5R	ECJ1VB0J106M	0603	6.3

### Input Capacitor

Higher value input capacitors help to reduce the input voltage ripple and improve transient response. Maximum input capacitor current is calculated using the following equation:

$$I_{CIN} \geq I_{LOAD(MAX)} \sqrt{\frac{V_{OUT}(V_{IN} - V_{OUT})}{V_{IN}}}$$

To minimize supply noise, place the input capacitor as close to the VINx pin of the buck as possible. As with the output capacitor, a low ESR capacitor is recommended.

The effective capacitance needed for stability, which includes temperature and dc bias effects, is a minimum of 3  $\mu\text{F}$  and a maximum of 10  $\mu\text{F}$ . A list of suggested capacitors is shown in Table 11.

**Table 11. Suggested 4.7  $\mu\text{F}$  Capacitors**

Vendor	Type	Model	Case Size	Voltage Rating (V)
Murata	X5R	GRM188R60J475ME19D	0402	6.3
Taiyo Yuden	X5R	JMK107BJ475	0402	6.3
Panasonic	X5R	ECJ-0EBOJ475M	0402	6.3

### LDO CAPACITOR SELECTION

#### Output Capacitor

The ADP5033 LDOs are designed for operation with small, space-saving ceramic capacitors, but function with most commonly used capacitors as long as care is taken with the ESR value. The ESR of the output capacitor affects the stability of the LDO control loop. A minimum of 0.70  $\mu\text{F}$  capacitance with an ESR of 1  $\Omega$  or less is recommended to ensure the stability of the ADP5033. Transient response to changes in load current is also affected by output capacitance. Using a larger value of output capacitance improves the transient response of the ADP5033 to large changes in load current.

#### Input Bypass Capacitor

Connecting a 1  $\mu\text{F}$  capacitor from VIN3 and VIN4 to ground reduces the circuit sensitivity to printed circuit board (PCB) layout, especially when long input traces or high source impedance is encountered. If greater than 1  $\mu\text{F}$  of output capacitance is required, increase the input capacitor to match it.

**Table 12. Suggested 1.0  $\mu\text{F}$  Capacitors**

Vendor	Type	Model	Case Size	Voltage Rating (V)
Murata	X5R	GRM155B30J105K	0402	6.3
TDK	X5R	C1005JB0J105KT	0402	6.3
Panasonic	X5R	ECJ0EBOJ105K	0402	6.3
Taiyo Yuden	X5R	LMK105BJ105MV-F	0402	10.0

### Input and Output Capacitor Properties

Use any good quality ceramic capacitors with the ADP5033 as long as they meet the minimum capacitance and maximum ESR requirements. Ceramic capacitors are manufactured with a variety of dielectrics, each with a different behavior over temperature and

applied voltage. Capacitors must have a dielectric adequate to ensure the minimum capacitance over the necessary temperature range and dc bias conditions. X5R or X7R dielectrics with a voltage rating of 6.3 V or 10 V are recommended for best performance. Y5V and Z5U dielectrics are not recommended for use with any LDO because of their poor temperature and dc bias characteristics.

Figure 46 depicts the capacitance vs. voltage bias characteristic of a 0402 1  $\mu\text{F}$ , 10 V, X5R capacitor. The voltage stability of a capacitor is strongly influenced by the capacitor size and voltage rating. In general, a capacitor in a larger package or higher voltage rating exhibits better stability. The temperature variation of the X5R dielectric is about  $\pm 15\%$  over the  $-40^\circ\text{C}$  to  $+85^\circ\text{C}$  temperature range and is not a function of package or voltage rating.

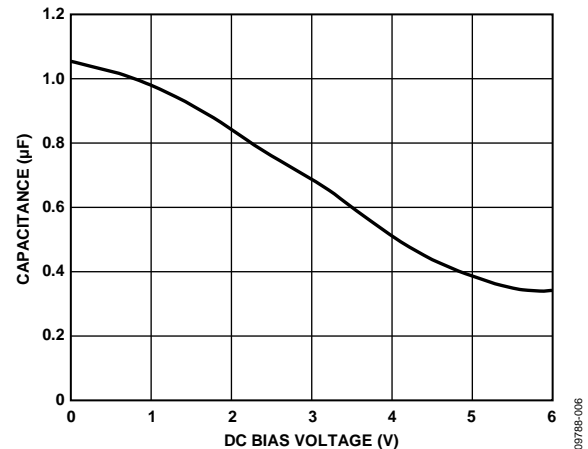

Figure 46. Capacitance vs. Voltage Characteristic

Use the following equation to determine the worst-case capacitance accounting for capacitor variation over temperature, component tolerance, and voltage:

$$C_{EFF} = C_{BIAS} \times (1 - TEMPCO) \times (1 - TOL)$$

where:

$C_{BIAS}$  is the effective capacitance at the operating voltage.

$TEMPCO$  is the worst-case capacitor temperature coefficient.

$TOL$  is the worst-case component tolerance.

In this example, the worst-case temperature coefficient ( $TEMPCO$ ) over  $-40^\circ\text{C}$  to  $+85^\circ\text{C}$  is assumed to be 15% for an X5R dielectric. The tolerance of the capacitor ( $TOL$ ) is assumed to be 10%, and  $C_{BIAS}$  is 0.85  $\mu\text{F}$  at 1.8 V, as shown in Figure 46.

Substituting these values into the following equation,

$$C_{EFF} = 0.85 \mu\text{F} \times (1 - 0.15) \times (1 - 0.1) \approx 0.65 \mu\text{F}$$

Therefore, the capacitor chosen in this example meets the minimum capacitance requirement of the LDO over temperature and tolerance at the chosen output voltage.

To guarantee the performance of the ADP5033, it is imperative that the effects of dc bias, temperature, and tolerances on the behavior of the capacitors be evaluated for each application.

## POWER DISSIPATION AND THERMAL CONSIDERATIONS

The ADP5033 is a highly efficient micropower management unit ( $\mu$ PMU), and, in most cases, the power dissipated in the device is not a concern. However, if the device operates at high ambient temperatures and maximum loading condition, the junction temperature can reach the maximum allowable operating limit (125°C).

When the temperature exceeds 150°C, the ADP5033 turns off all the regulators, allowing the device to cool down. When the die temperature falls below 130°C, the ADP5033 resumes normal operation.

This section provides guidelines to calculate the power dissipated in the device and ensure that the ADP5033 operates below the maximum allowable junction temperature.

The efficiency for each regulator on the ADP5033 is given by

$$\eta = \frac{P_{OUT}}{P_{IN}} \times 100\% \quad (1)$$

where:

$\eta$  is the efficiency.

$P_{IN}$  is the input power.

$P_{OUT}$  is the output power.

Power loss is given by

$$P_{LOSS} = P_{IN} - P_{OUT} \quad (2a)$$

or

$$P_{LOSS} = P_{OUT} (1 - \eta) / \eta \quad (2b)$$

Power dissipation can be calculated in several ways. The most intuitive and practical is to measure the power dissipated at the input and all the outputs. Perform the measurements at the worst-case conditions (voltages, currents, and temperature). The difference between input and output power is dissipated in the device and the inductor. Use Equation 4 to derive the power lost in the inductor and, from this, use Equation 3 to calculate the power dissipation in the ADP5033 buck converter.

A second method to estimate the power dissipation uses the efficiency curves provided for the buck regulator, and the power lost on each LDO can be calculated using Equation 12. When the buck efficiency is known, use Equation 2b to derive the total power lost in the buck regulator and inductor, use Equation 4 to derive the power lost in the inductor, and then calculate the power dissipation in the buck converter using Equation 3. Add the power dissipated in the buck and in the two LDOs to find the total dissipated power.

Note that the buck efficiency curves are typical values and may not be provided for all possible combinations of  $V_{IN}$ ,  $V_{OUT}$ , and  $I_{OUT}$ . To account for these variations, it is necessary to include a safety margin when calculating the power dissipated in the buck.

A third way to estimate the power dissipation is analytical and involves modeling the losses in the buck circuit provided by Equation 8 to Equation 11 and the losses in the LDO provided by Equation 12.

### BUCK REGULATOR POWER DISSIPATION

The power loss of the buck regulator is approximated by

$$P_{LOSS} = P_{DBUCK} + P_L \quad (3)$$

where:

$P_{DBUCK}$  is the power dissipation on one of the ADP5033 buck regulators.

$P_L$  is the inductor power losses.

The inductor losses are external to the device, and they do not have any effect on the die temperature.

The inductor losses are estimated (without core losses) by

$$P_L \approx I_{OUT1(RMS)}^2 \times DCR_L \quad (4)$$

where:

$DCR_L$  is the inductor series resistance.

$I_{OUT1(RMS)}$  is the rms load current of the buck regulator.

$$I_{OUT1(RMS)} = I_{OUT1} \times \sqrt{1 + \frac{r}{12}} \quad (5)$$

where  $r$  is the normalized inductor ripple current

$$r = V_{OUT1} \times (1 - D) / (I_{OUT1} \times L \times f_{SW}) \quad (6)$$

where:

$L$  is the inductance.

$f_{SW}$  is the switching frequency.

$D$  is the duty cycle.

$$D = V_{OUT1} / V_{IN1} \quad (7)$$

The ADP5033 buck regulator power dissipation,  $P_{DBUCK}$ , includes the power switch conductive losses, the switch losses, and the transition losses of each channel. There are other sources of loss, but these are generally less significant at high output load currents, where the thermal limit of the application is. Equation 8 captures the calculation that must be made to estimate the power dissipation in the buck regulator.

$$P_{DBUCK} = P_{COND} + P_{SW} + P_{TRAN} \quad (8)$$

The power switch conductive losses are due to the output current,  $I_{OUT1}$ , flowing through the P-MOSFET and the N-MOSFET power switches that have internal resistance,  $R_{DS_{ON-P}}$  and  $R_{DS_{ON-N}}$ . The amount of conductive power loss is found by

$$P_{COND} = [R_{DS_{ON-P}} \times D + R_{DS_{ON-N}} \times (1 - D)] \times I_{OUT1(RMS)}^2 \quad (9)$$

where  $R_{DS_{ON-P}}$  is approximately 0.2  $\Omega$ , and  $R_{DS_{ON-N}}$  is approximately 0.16  $\Omega$  at 25°C junction temperature and  $V_{IN1} = V_{IN2} = 3.6$  V. At  $V_{IN1} = V_{IN2} = 2.3$  V, these values change to 0.31  $\Omega$  and 0.21  $\Omega$ , respectively, and at  $V_{IN1} = V_{IN2} = 5.5$  V, the values are 0.16  $\Omega$  and 0.14  $\Omega$ , respectively.

Switching losses are associated with the current drawn by the driver to turn on and turn off the power devices at the switching frequency. The amount of switching power loss is given by

$$P_{SW} = (C_{GATE-P} + C_{GATE-N}) \times V_{INI}^2 \times f_{SW} \quad (10)$$

where:

$C_{GATE-P}$  is the P-MOSFET gate capacitance.

$C_{GATE-N}$  is the N-MOSFET gate capacitance.

For the ADP5033, the total of ( $C_{GATE-P} + C_{GATE-N}$ ) is approximately 150 pF.

The transition losses occur because the P-channel power MOSFET cannot be turned on or off instantaneously, and the SW node takes some time to slew from near ground to near  $V_{OUT1}$  (and from  $V_{OUT1}$  to ground). The amount of transition loss is calculated by

$$P_{TRAN} = V_{INI} \times I_{OUT1} \times (t_{RISE} + t_{FALL}) \times f_{SW} \quad (11)$$

where  $t_{RISE}$  and  $t_{FALL}$  are the rise time and the fall time of the switching node, SW. For the ADP5033, the rise and fall times of SW are in the order of 5 ns.

If the preceding equations and parameters are used for estimating the converter efficiency, it must be noted that the equations do not describe all of the converter losses, and the parameter values given are typical numbers. The converter performance also depends on the choice of passive components and board layout; therefore, a sufficient safety margin should be included in the estimate.

### LDO Regulator Power Dissipation

The power loss of an LDO regulator is given by

$$P_{DLDO} = [(V_{IN} - V_{OUT}) \times I_{LOAD}] + (V_{IN} \times I_{GND}) \quad (12)$$

where:

$I_{LOAD}$  is the load current of the LDO regulator.

$V_{IN}$  and  $V_{OUT}$  are input and output voltages of the LDO, respectively.

$I_{GND}$  is the ground current of the LDO regulator.

Power dissipation due to the ground current is small, and it can be ignored.

The total power dissipation in the ADP5033 simplifies to

$$P_D = P_{DDBUCK1} + P_{DDBUCK2} + P_{DLDO1} + P_{DLDO2} \quad (13)$$

## JUNCTION TEMPERATURE

In cases where the board temperature  $T_A$  is known, the thermal resistance parameter,  $\theta_{JA}$ , can be used to estimate the junction temperature rise.  $T_J$  is calculated from  $T_A$  and  $P_D$  using the formula

$$T_J = T_A + (P_D \times \theta_{JA}) \quad (14)$$

The typical  $\theta_{JA}$  value for the 16-ball, 0.5 mm pitch WLCSP is 57°C/W (see Table 7). A very important factor to consider is that  $\theta_{JA}$  is based on a 4-layer 4 in × 3 in, 2.5 oz copper, as per JEDEC standard, and real applications may use different sizes and layers. It is important to maximize the copper used to remove the heat from the device. Copper exposed to air dissipates heat better than copper used in the inner layers. The exposed pad should be connected to the ground plane with several vias.

If the case temperature can be measured, the junction temperature is calculated by

$$T_J = T_C + (P_D \times \Psi_{JB}) \quad (15)$$

where  $T_C$  is the case temperature and  $\Psi_{JB}$  is the junction-to-board thermal resistance provided in Table 7.

When designing an application for a particular ambient temperature range, calculate the expected ADP5033 power dissipation ( $P_D$ ) due to the losses of all channels by using the Equation 8 to Equation 13. From this power calculation, the junction temperature,  $T_J$ , can be estimated using Equation 14.

The reliable operation of the converter and the two LDO regulators can be achieved only if the estimated die junction temperature of the ADP5033 (Equation 14) is less than 125°C. Reliability and mean time between failures (MTBF) is highly affected by increasing the junction temperature. Additional information about product reliability can be found in the *ADI Reliability Handbook*, which can be found at [www.analog.com/reliability\\_handbook](http://www.analog.com/reliability_handbook).

## PCB LAYOUT GUIDELINES

Poor layout can affect [ADP5033](#) performance, causing electromagnetic interference (EMI) and electromagnetic compatibility (EMC) problems, ground bounce, and voltage losses. Poor layout can also affect regulation and stability. A good layout is implemented using the following guidelines:

- Place the inductor, input capacitor, and output capacitor close to the IC using short tracks. These components carry high switching frequencies, and large tracks act as antennas.
- Route the output voltage path away from the inductor and SW node to minimize noise and magnetic interference.
- Maximize the size of ground metal on the component side to help with thermal dissipation.
- Use a ground plane with several vias connecting to the component side ground to further reduce noise interference on sensitive circuit nodes.
- Connect VIN1 and VIN2 together close to the IC using short tracks.

TYPICAL APPLICATION SCHEMATIC

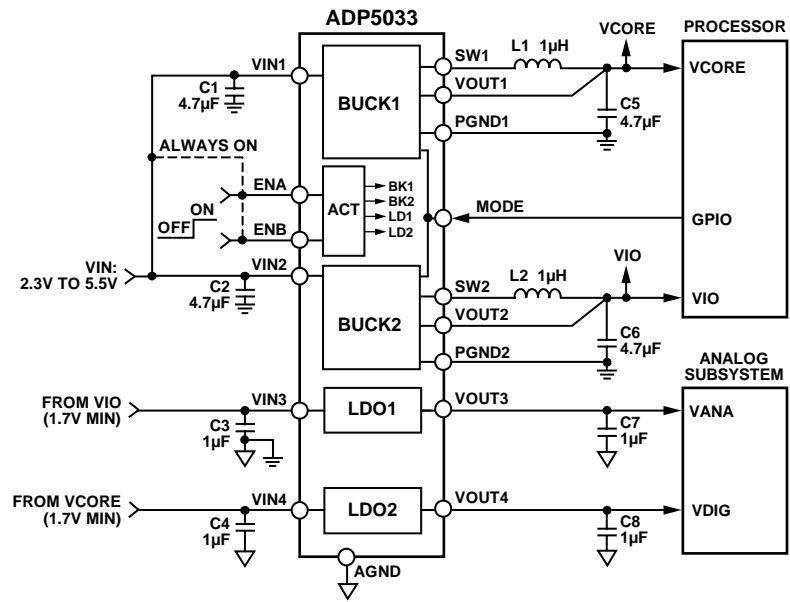

Figure 47. Processor System Power Management with PSM/PWM Control

09788-152



# OUTLINE DIMENSIONS

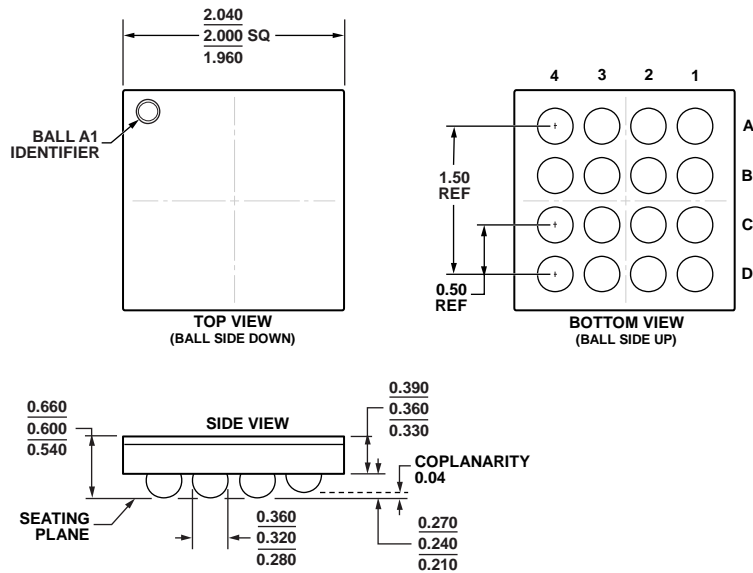

Figure 48. 16-Ball Wafer Level Chip Scale Package [WLCSP]  
 Back-Coating Included  
 (CB-16-8)  
 Dimensions shown in millimeters

10-19-2012-B

## ORDERING GUIDE

Model <sup>1</sup>	Temperature Range	Output Voltage (V) <sup>2</sup>	Options	ENA Controlled Channels <sup>3</sup>	Package Description	Package Option	Marking Code
ADP5033ACBZ-1-R7	-40°C to +125°C	VOUT1: 1.2 V, VOUT2: 3.3 V, VOUT3: 2.8 V, VOUT4: 1.8 V	UVLO: low, pull-downs on buck channels only	BUCK2, LDO1	16-Ball WLCSP	CB-16-8	LHX
ADP5033ACBZ-2-R7	-40°C to +125°C	VOUT1: 1.8 V, VOUT2: 2.8 V, VOUT3: 2.8 V, VOUT4: 3.0 V	UVLO: low, pull-downs on all channels	BUCK1, BUCK2, LDO1	16-Ball WLCSP	CB-16-8	LMD
ADP5033ACBZ-3-R7	-40°C to +125°C	VOUT1: 3.0 V, VOUT2: 1.2 V, VOUT3: 1.8 V, VOUT4: 3.0 V	UVLO: low, pull-downs on all channels	BUCK1, LDO1, LDO2	16-Ball WLCSP	CB-16-8	LNC
ADP5033ACBZ-4-R7	-40°C to +125°C	VOUT1: 0.9 V, VOUT2: 0.9 V, VOUT3: 3.0 V, VOUT4: 2.8 V	UVLO: low, pull-downs disabled	BUCK1, BUCK2	16-Ball WLCSP	CB-16-8	LNR
ADP5033ACBZ-5-R7	-40°C to +125°C	VOUT1: 3.3 V, VOUT2: 1.8 V, VOUT3: 1.2 V, VOUT4: 1.5 V	UVLO: low, pull-downs on all channels	BUCK1	16-Ball WLCSP	CB-16-8	LQ3
ADP5033ACBZ-6-R7	-40°C to +125°C	VOUT1: 1.8 V, VOUT2: 2.5 V, VOUT3: 3.0 V, VOUT4: 3.0 V	UVLO: low, pull-downs on all channels	BUCK1, LDO1	16-Ball WLCSP	CB-16-8	LQ5
ADP5033ACBZ-7-R7	-40°C to +125°C	VOUT1: 1.1 V, VOUT2: 1.8 V, VOUT3: 2.5 V, VOUT4: 3.2 V	UVLO: low, pull-downs on all channels	BUCK1	16-Ball WLCSP	CB-16-8	LRB
ADP5033ACBZ-8-R7	-40°C to +125°C	VOUT1: 2.8 V, VOUT2: 1.5 V, VOUT3: 2.8 V, VOUT4: 1.8 V	UVLO: low, pull-downs on all channels	BUCK1, BUCK2, LDO2	16-Ball WLCSP	CB-16-8	LRC
ADP5033ACBZ-9-R7	-40°C to +125°C	VOUT1: 1.1 V, VOUT2: 1.8 V, VOUT3: 1.2 V, VOUT4: 3.2 V	UVLO: low, pull-downs on all channels	BUCK1	16-Ball WLCSP	CB-16-8	LRD
ADP5033ACBZ-10-R7	-40°C to +125°C	VOUT1: 1.8 V, VOUT2: 3.3 V, VOUT3: 1.8 V, VOUT4: 3.3 V	UVLO: low, pull-downs on all channels	BUCK1, LDO1	16-Ball WLCSP	CB-16-8	LV6
ADP5033ACBZ-11-R7	-40°C to +125°C	VOUT1: 1.2 V, VOUT2: 3.3 V, VOUT3: 1.8 V, VOUT4: 2.5 V	UVLO: low, pull-downs on all channels	BUCK1, BUCK2	16-Ball WLCSP	CB-16-8	LV7
ADP5033-1-EVALZ					Evaluation Board for ADP5033ACBZ- 1-R7		

<sup>1</sup> Z = RoHS Compliant Part.

<sup>2</sup> For additional options, contact a local sales or distribution representative. Additional options available include the following:

BUCK1 and BUCK2: 3.3 V, 3.0 V, 2.8 V, 2.5 V, 2.3 V, 2.0 V, 1.8 V, 1.6 V, 1.5 V, 1.4 V, 1.3 V, 1.2 V, 1.1 V, 1.0 V, or 0.9 V.

LDO1 and LDO2: 3.3 V, 3.0 V, 2.8 V, 2.5 V, 2.25 V, 2 V, 1.8 V, 1.7 V, 1.6 V, 1.5 V, 1.2 V, 1.1 V, 1.0 V, 0.9 V, or 0.8 V.

UVLO: low or high.

In addition, for BUCK1, BUCK2, LDO1, and LDO2, active pull-down resistor is programmable to be either enabled or disabled.

<sup>3</sup> ENA activated channels (ENB controls the other channels).

**NOTES**

**NOTES**