

Key-type Selector Switches

A22NK

Keyed 22-mm Selector Switches

Universal Design.

Emphasis on Color Coding, Workability, and Safety.

Easy to Use

- You can connect up to three Contact Blocks in one stage for multistage expansion.
- The terminals can be retightened when Contact Blocks are stacked.
- Contact Blocks can be attached in any direction for easy assembly.
- Screw terminal structure is compatible with round crimp terminals.

Safety

- Easy-to-operate lock lever for secure locking.
- Easy-mounting Contact Blocks provide finger protection.
- Different colors of Contact Blocks (NO: blue, NC: orange) help prevent wiring errors.

Product Lineup

- Meet global safety standards.
- Available with metal or plastic bezels.
- All models are keyed alike.
- Standard-feature degree of protection: IP66 and NEMA 13.

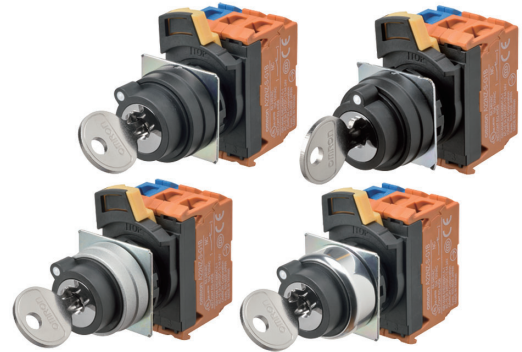

 Refer to *Safety Precautions for All Pushbutton Switches/Indicators* and *Safety Precautions* in the A22NN/A22NL datasheet

A22NK

Model Number Structure

Model Number Legend

----- Shipped as a set that includes the Operation Unit, Mounting Collar, and Contact Block.
For information on combinations, refer to *Ordering Information* on pages 5 to 6.

Model Numbers for Sets

A 2 2 N ⁽¹⁾ **K** - ⁽²⁾ **2B** ⁽³⁾ **M** - ⁽⁴⁾ **01** ⁽⁵⁾ **A** ⁽⁶⁾ **A** - ⁽⁷⁾ **G** ⁽⁸⁾ **100**

(1) Type

Code	Type
K	Key-type Selector Switch

(4) Key Number

Code	No.
01	No.1

(7) Contact Specification

Code	Description
G	General purpose

(2) Number of Positions and Bezel Material

Code	No. of positions	Bezel material
2B	2	Plastic
2M	2	Brushed metal
2R	2	Metal
3B	3	Plastic
3M	3	Brushed metal
3R	3	Metal

(5) Key Release Position

Code	Release position	Two positions	Three positions
A	All positions		
B	Left		
D	Center	---	
G	Left and right	---	

(8) Contact Configuration

Code	Contact Blocks		Switch Position			Two positions	Three positions
	NO	NC	1	2	3		
100	1	0	NO	---	---	Yes	---
002	0	1	---	---	NC	Yes	---
101	2	0	NO	---	NO	Yes	Yes
102	1	1	NO	---	NC	Yes	Yes
201	1	1	NC	---	NO	---	Yes
202	0	2	NC	---	NC	Yes	Yes
110	2	0	NO	NO	---	---	Yes
112	2	1	NO	NO	NC	Yes	Yes
210	1	1	NC	NO	---	---	Yes
011	2	0	---	NO	NO	---	Yes
012	1	1	---	NO	NC	---	Yes
120	1	1	NO	NC	---	---	Yes
220	0	2	NC	NC	---	---	Yes
021	1	1	---	NC	NO	---	Yes
022	0	2	---	NC	NC	---	Yes

(3) Reset Method

Code	Reset method		
M	Manual	Two-positions manual	
		Three-positions manual	
L	Automatic reset on left	Two-positions automatic	
		Three-positions left automatic	
B	Automatic reset on left and right	Three-positions left or right automatic	

○: Release position
●: Locked position

(6) Degree of Protection

Code	Protection
A	IP66, NEMA13

Note: 1. NO (blue): Normally open, NC (orange): Normally closed.
2. Refer to the following figure for Unit positions.

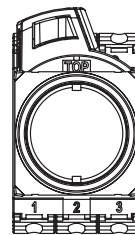

Operation Angle

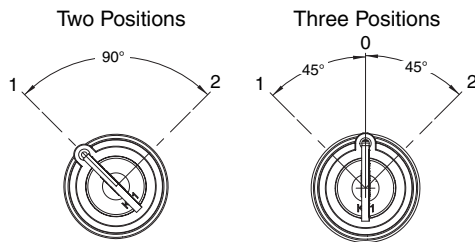

Note: Not all assembled configurations are possible. Please refer to the subassemblies section for additional options. Please refer to the specifications section for examples of linked contact block options.

■ Specifications: Refer to page 10 and refer to the A22NN/A22NL. ■ Precautions for correct use: Refer to the A22NN/A22NL.
■ Dimensions: Refer to page 11.

Structure

Contact Configuration Table

Two Positions

No. of outputs	Code	Contact configuration	Unit position	Contacts	Position	
					1	2
1	100	SPST-NO	(1)	NO		ON
			(2)	---	---	---
			(3)	---	---	---
1	002	SPST-NC	(1)	---	---	---
			(2)	---	---	---
			(3)	NC	ON	
2	102	SPST-NO/ SPST-NC	(1)	NO		ON
			(2)	---	---	---
			(3)	NC	ON	
2	101	DPST-NO	(1)	NO		ON
			(2)	---	---	---
			(3)	NO		ON
2	202	DPST-NC	(1)	NC	ON	
			(2)	---	---	---
			(3)	NC	ON	
3	111	3PST-NO	(1)	NO		ON
			(2)	NO		ON
			(3)	NO		ON
3	222	3PST-NC	(1)	NC	ON	
			(2)	NC	ON	
			(3)	NC	ON	
3	122	SPST-NO/ DPST-NC	(1)	NO		ON
			(2)	NC	ON	
			(3)	NC	ON	
3	112	DPST-NO/ SPST-NC	(1)	NO		ON
			(2)	NO		ON
			(3)	NC	ON	

Operation Angle

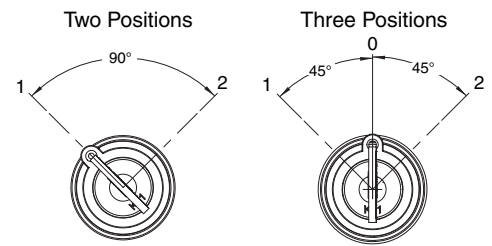

Note: Not all assembled configurations are possible. Please refer to the subassemblies section for additional options. Please refer to the specifications section for examples of linked contact block options.

Three Positions

No. of outputs	Code	Contact configuration	Unit position	Contacts	Position		
					1	0	2
2	110	DPST-NO	(1)	NO	ON		
			(2)	NO	ON		ON
			(3)	---	---	---	---
2	011	DPST-NO	(1)	---	---	---	---
			(2)	NO	ON		ON
			(3)	NO			ON
2	101	DPST-NO	(1)	NO	ON		
			(2)	---	---	---	---
			(3)	NO			ON
2	220	DPST-NC	(1)	NC		ON	ON
			(2)	NC		ON	
			(3)	---	---	---	---
2	022	DPST-NC	(1)	---	---	---	---
			(2)	NC		ON	
			(3)	NC	ON	ON	
2	202	DPST-NC	(1)	NC		ON	ON
			(2)	---	---	---	---
			(3)	NC	ON	ON	
2	120	SPST-NO/ SPST-NC	(1)	NO	ON		
			(2)	NC		ON	
			(3)	---	---	---	---

No. of outputs	Code	Contact configuration	Unit position	Contacts	Position		
					1	0	2
2	102	SPST-NO/ SPST-NC	(1)	NO	ON		
			(2)	---	---	---	---
			(3)	NC	ON	ON	
2	210	SPST-NO/ SPST-NC	(1)	NC		ON	ON
			(2)	NO	ON		ON
			(3)	---	---	---	---
2	201	SPST-NO/ SPST-NC	(1)	NC		ON	ON
			(2)	---	---	---	---
			(3)	NO			ON
2	012	SPST-NO/ SPST-NC	(1)	---	---	---	---
			(2)	NO	ON		ON
			(3)	NC	ON	ON	
2	021	SPST-NO/ SPST-NC	(1)	---	---	---	---
			(2)	NC		ON	
			(3)	NO			ON
3	111	3PST-NO	(1)	NO	ON		
			(2)	NO	ON		ON
			(3)	NO			ON
3	222	3PST-NC	(1)	NC		ON	ON
			(2)	NC		ON	
			(3)	NC	ON	ON	
3	122	SPST-NO/ DPST-NC	(1)	NO	ON		
			(2)	NC		ON	
			(3)	NC	ON	ON	
3	212	SPST-NO/ DPST-NC	(1)	NC		ON	ON
			(2)	NO	ON		ON
			(3)	NC	ON	ON	
3	221	SPST-NO/ DPST-NC	(1)	NC		ON	ON
			(2)	NC		ON	
			(3)	NO	ON		ON
3	211	DPST-NO/ SPST-NC	(1)	NC		ON	ON
			(2)	NO	ON		ON
			(3)	NO			ON
3	121	DPST-NO/ SPST-NC	(1)	NO	ON		
			(2)	NC		ON	
			(3)	NO			ON
3	112	DPST-NO/ SPST-NC	(1)	NO	ON		
			(2)	NO	ON		ON
			(3)	NC	ON	ON	

Operation Angle

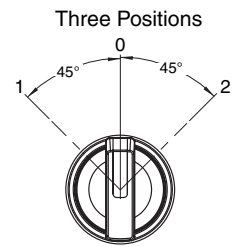



Note: Some combinations are only available through subassemblies.
Please refer to the specifications section for more information.



Ordering Information

Model Numbers for Sets - - - Shipped as a set that includes the Operation Unit, Mounting Collar, and Contact Block.

Two-position, Key-type Selector Switches

Appearance	Bezel material	No. of outputs	Model	(3) Reset method	(5) Key release positions	(8)(8)(8) Contact configuration				
Plastic bezels 	2B	1	A22NK-2B(3)-01(5)A-G(8)(8)(8)	M: Manual L: Automatic reset on left	A: All positions B: Left	100 002				
		2				102 101 202				
Brushed metal bezels 	2M	1	A22NK-2M(3)-01(5)A-G(8)(8)(8)			M: Manual L: Automatic reset on left	A: All positions B: Left	100 002		
		2						102 101 202		
Metal bezels 	2R	1	A22NK-2R(3)-01(5)A-G(8)(8)(8)					M: Manual L: Automatic reset on left	A: All positions B: Left	100 002
		2								102 101 202

Three-position, Key-type Selector Switches

Appearance	Bezel material	No. of outputs	Model	(3) Reset method	(5) Key release positions	(8)(8)(8) Contact configuration
Plastic bezels 	3B	2	A22NK-3B(3)-01(5)A-G(8)(8)(8)			110 011 101 220 022 202 120 102 210 201 012 021
Brushed metal bezels 	3M	2	A22NK-3M(3)-01(5)A-G(8)(8)(8)	M: Manual B: Automatic reset on left and right	B: Left D: Center G: Left and right	110 011 101 220 022 202 120 102 210 201 012 021
Metal bezels 	3R	2	A22NK-3R(3)-01(5)A-G(8)(8)(8)			110 011 101 220 022 202 120 102 210 201 012 021

Note: Not all assembled configurations are possible.
Please refer to the subassemblies section for additional options.
Please refer to the specifications section for examples of linked contact block options.

■ Subassemblies: Refer to pages 7 to 9.
(You can order Operation Units, Mounting Collars, and Contact Blocks individually.)

■ Specifications: Refer to page 10 and refer to the A22NN/A22NL.
■ Dimensions: Refer to page 11.
■ Accessories and tools: Refer to the A22NN/A22NL.

Ordering Information

Subassemblies - - - - You can order Operation Units, Mounting Collars, and Contact Blocks individually. Use them in combination for models that are not available as assembled Switches. They can also be used as inventory for maintenance parts.

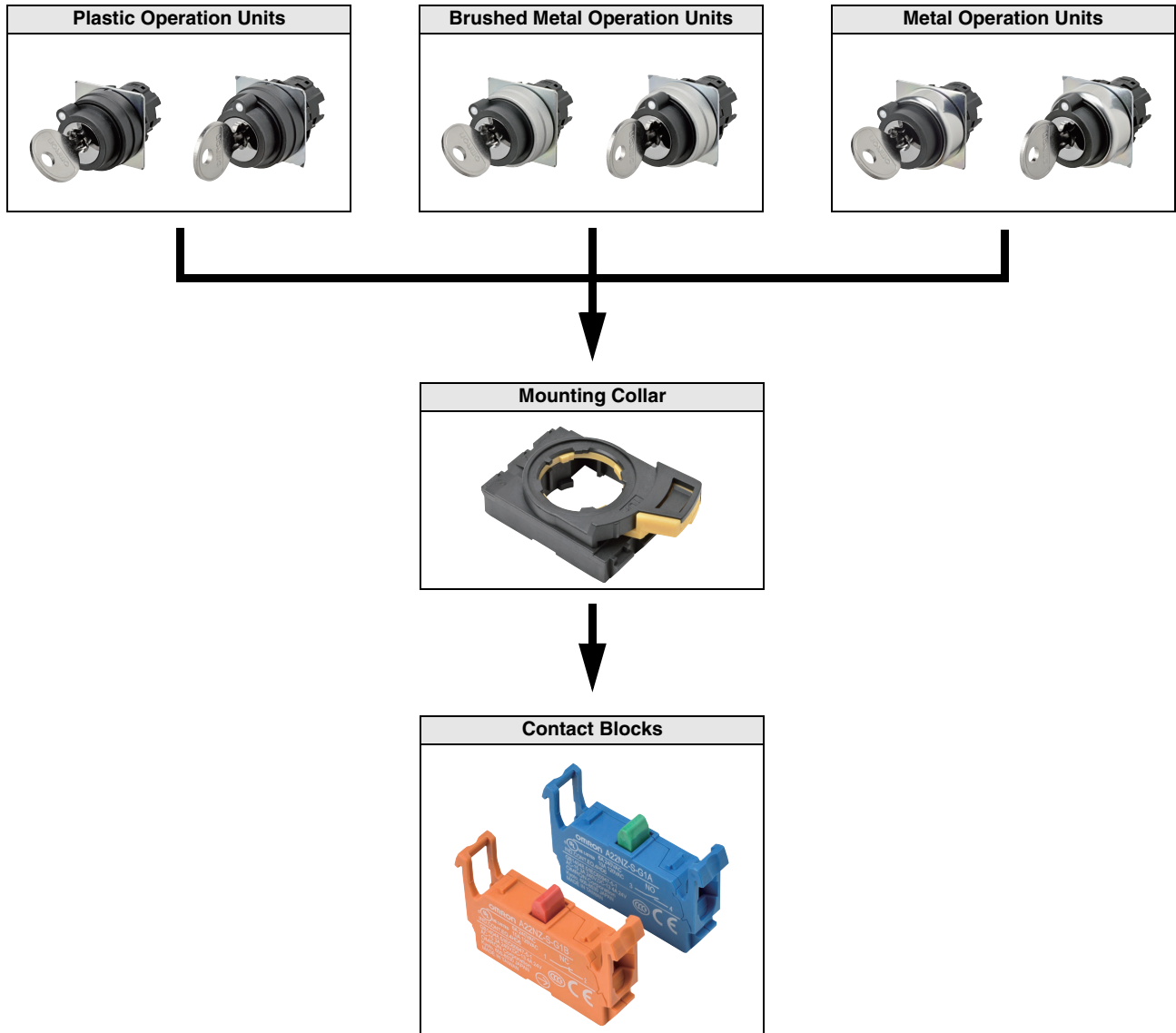

Note: Use a Reinforcement Plate for greater strength.



■ Model numbers of sets: Refer to page 5.



■ Specifications: Refer to page 10 and refer to the A22NN/A22NL.
 ■ Dimensions: Refer to page 11.
 ■ Accessories and tools: Refer to the A22NN/A22NL.

A22NK

Ordering Information

Subassemblies - - - - You can order Operation Units, Mounting Collars, and Contact Blocks individually. Use them in combination for models that are not available as assembled Switches. They can also be used as inventory for maintenance parts.

Operation Units

Bezel material and shape		Plastic	Brushed metal	Metal	(1) Key release positions
					
No. of positions	Reset method	Model	Model	Model	
2	Manual	A22NZ-2BM-01(1)A	A22NZ-2MM-01(1)A	A22NZ-2RM-01(1)A	A: All positions B: Left C: Right
	Automatic reset on left	A22NZ-2BL-01(1)A	A22NZ-2ML-01(1)A	A22NZ-2RL-01(1)A	
3	Manual	A22NZ-3BM-01(1)A	A22NZ-3MM-01(1)A	A22NZ-3RM-01(1)A	A: All positions B: Left C: Right D: Center G: Left and right
	Automatic reset on left	A22NZ-3BL-01(1)A	A22NZ-3ML-01(1)A	A22NZ-3RL-01(1)A	
	Automatic reset on right	A22NZ-3BR-01(1)A	A22NZ-3MR-01(1)A	A22NZ-3RR-01(1)A	
	Automatic reset on left and right	A22NZ-3BB-01(1)A	A22NZ-3MB-01(1)A	A22NZ-3RB-01(1)A	

■ Model numbers of sets: Refer to page 5.

■ Specifications: Refer to page 10 and refer to the A22NN/A22NL.
 ■ Dimensions: Refer to page 11.
 ■ Accessories and tools: Refer to the A22NN/A22NL.

Ordering Information

Subassemblies -- You can order Operation Units, Mounting Collars, and Contact Blocks individually. Use them in combination for models that are not available as assembled Switches. They can also be used as inventory for maintenance parts.

Mounting Collar

Appearance	Model
	A22NZ-H-01

Contact Blocks

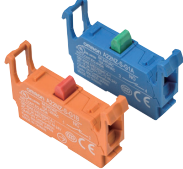
Appearance	Contact Specification	Model
	SPST-NO (blue)	A22NZ-S-G1A
	SPST-NC (orange)	A22NZ-S-G1B

Reinforcement Plate

Appearance	Model
	A22NZ-A-C01

Accessories

Appearance	Model
Key 	A22NZ-K-01

A22NK

Specifications

Characteristics

Item	Type	Key-type Selector Switches
	Allowable operating frequency	Mechanical
Electrical		30 operations/minute max.
Insulation resistance		100 MΩ min. (at 500 VDC)
Contact resistance		100 mΩ max. (initial value)
Dielectric strength	Between terminals of same polarity	2,500 VAC at 50/60 Hz for 1 min
	Between each terminal and ground	2,500 VAC at 50/60 Hz for 1 min
Vibration resistance	Malfunction	10 to 55 Hz, 1.5-mm double amplitude (malfunction within 1 ms)
Shock resistance	Malfunction	1,000 m/s ² max. (malfunction within 1 ms)
Durability	Mechanical	500,000 operations min. (Switches with 3 positions: 300,000 operations min.)
	Electrical	500,000 operations min. (Switches with 3 positions: 300,000 operations min.)
Ambient operating temperature* ¹		-25 to 70°C
Ambient operating humidity		35% to 85% RH
Ambient storage temperature* ¹		-40 to 80°C
Degree of protection* ²		IP66, NEMA13
Electric shock protection class		Class II
PTI (tracking characteristic)		175
Degree of contamination (application environment)		3 (IEC 60947-5-1)
Weight		Approx. 65 g (for 1NC/1NO)

*1. With no icing or condensation.

*2. Degree of protection from the front of the panel.

Operating Characteristics (for SPST-NO/SPST-NC)

Item	Type	Key-type Selector Switches	
		Manual reset	Automatic reset
Total travel force (torque) (maximum TTF)		0.6 N·m	0.6 N·m
Total travel (TT)		2 positions: Approx. 90°, 3 positions: Approx. 45°	
Resetting force (torque) (RF)		0.5 N·m max.	---

Examples of Linked Contact Blocks

 Contact Blocks

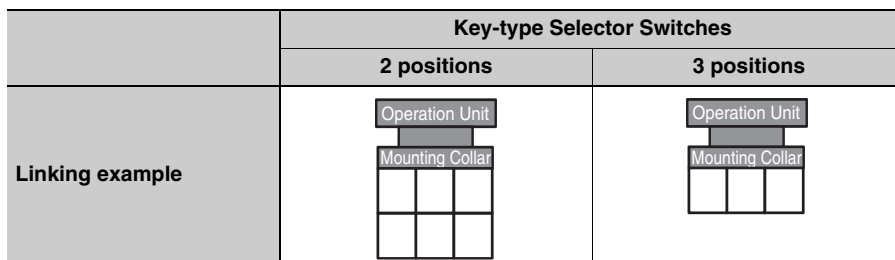

Note: If you increase the number of Contact Blocks, evaluate the Switch under actual working conditions before permanent installation and use the Switch within a number of switching operations that will not adversely affect the Switch's performance.

Dimensions

Lighted and Non-lighted Key-type Selection Switches

Two-position Switches with Plastic Bezels

A22NK-2B□

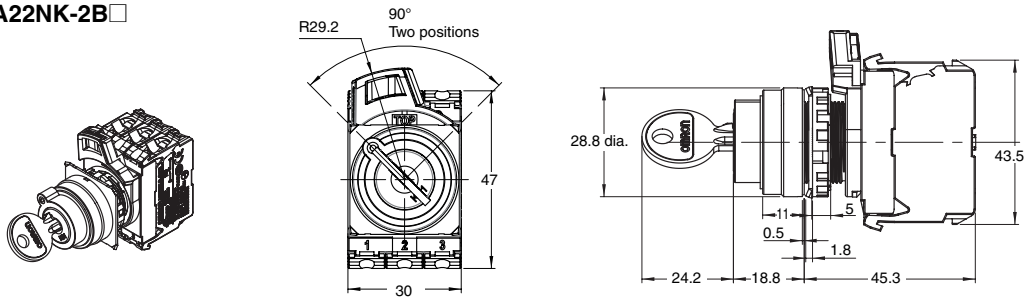

Three-position Switches with Plastic Bezels

A22NK-3B□

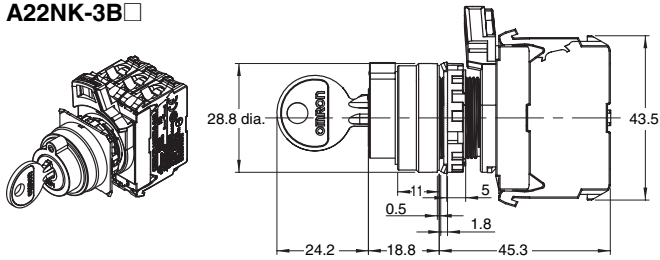

Two-position Switches with Brushed Metal Bezels

A22NK-2M□

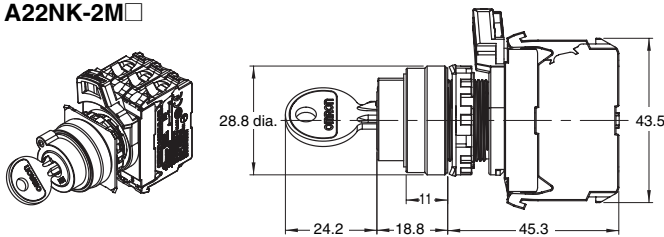

Three-position Switches with Brushed Metal Bezels

A22NK-3M□

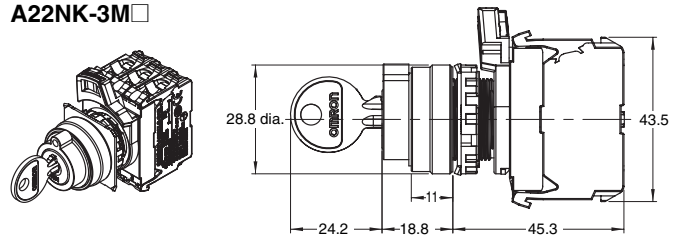

Two-position Switches with Metal Bezels

A22NK-2R□

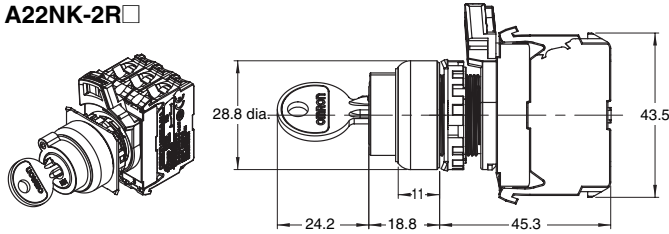

Three-position Switches with Metal Bezels

A22NK-3R□

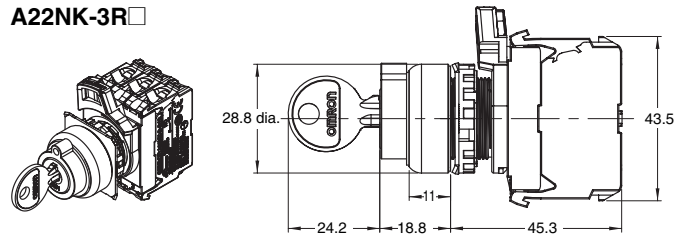

Depth with Linked Units

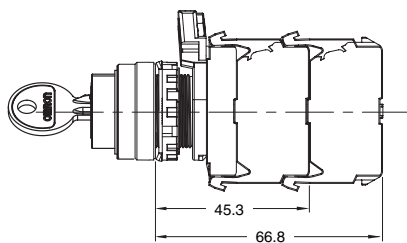

Terminal Wiring Diagrams Bottom View

2NO/1NC
Contact configuration
code:112

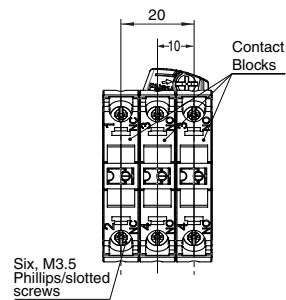

Terminal Connection Diagrams

2NO/1NC
Contact configuration
code:112

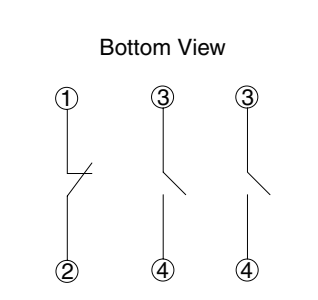

A22NK

Safety Precautions

Refer to *Safety Precautions for All Pushbutton Switches/Indicators* for common precautions.
Read the *Safety Precautions* in the A22NN/A22NL datasheet.

Precautions for Correct Use

Insert the key all of the way to the back of the cylinder before you turn it.

Safety Precautions

Refer to Safety Precautions for All Pushbutton Switches/Indicators.

Precautions for Safe Use

- Never perform wiring work on a Switch while power is being supplied. Never touch terminals and other charged parts while power is being supplied. Doing so may result in electrical shock.
- Never attempt to disassemble or modify the Switch in any way. Doing so may prevent correct operation.
- Switch functionality may be inhibited. Do not drop the Switch. Never apply a force that would deform or alter the nature of the Switch.
- The durability of the Switch is greatly affected by operating conditions. Evaluate the Switch under actual working conditions before permanent installation and use the Switch within a number of switching operations that will not adversely affect the Switch's performance.
- Do not use a load voltage or current that exceeds the rating. Doing so may damage or cause burning in the Switch.
- Do not use the Switch in a location with inflammable or explosive gases, or where the Switch would be subjected to inflammable solvents. The arcs and heat generated when the Switch is operated can cause ignition or explosions.
- Do not use the Switch where sulfur gas (H₂S, SO₂), ammonia gas (NH₃), nitric acid gas (HNO₃), chlorine gas (Cl₂), or other harmful gases are present or where high humidity is present. Contact faults and damage due to corrosion may interfere with the functionality of the Switch.
- Do not use the Switch in oil or water or in an environment subject to constant contact with oil or water. The oil or water may enter the Switch, causing failure.
- Do not use or store the Switch in the following locations.
 - Locations subject to rapid temperature changes
 - Locations subject to condensation due to high humidity
 - Locations subject to vibration
 - Locations subject to direct sunlight
 - Locations subject to salty air
- Make sure that the rubber washer is in place between the Operation Unit and the panel. Otherwise, the specifications of the protective structure may not be satisfied.
- Do not subject the Contact Block or wiring to excessive force. The Contact Block may be damaged or deformed and faulty contact may occur.

Precautions for Correct Use

Mounting

- Do not tighten the Mounting Nut more than necessary using tools such as pointed-nose pliers. Doing so will damage the Mounting Nut. (The tightening torque of the Mounting Nut is 1.0 to 2.0 N·m.)

Wiring

- Terminal screws must be M3.5 Phillips or slotted screws with a square washer.
- The terminal screw tightening torque is 1.0 to 1.3 N·m.
- Solid wires, stranded wires, and crimp terminals can be connected to the Switch.

Stranded wires: AWG14 to AWG16

Solid wire: 1.6 dia. max.

Bare Crimp Terminals

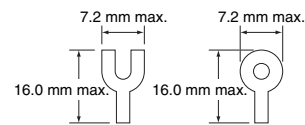

Crimp Terminals with Insulating Sheaths

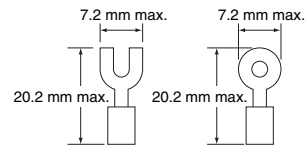

- After wiring the Switch, maintain appropriate clearance and creepage distances.

Operating Environment

- The Switch is intended for indoor use only. Using the Switch outdoors will result in failure.

LED Lamps

- A current-limiting resistor is built into the LED Lamp, so external resistance is not required.
- False Lighting of the LED Lamp
The LED Lamp will light with a microcurrent of approx. 0.1 mA or less. Take countermeasures, such as adding a resistor in parallel to the LED Lamp, to prevent false lighting.
The micro-current varies with the machine (due to leakage current, stray capacity between cables, etc.). Select a resistance value and allowable power consumption according to the actual current.

Example of Circuit to Prevent False Lighting

For 24 VAC/VDC Lighting Unit

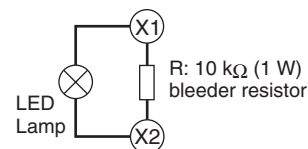

Application

Mounting to the Panel

Panel Hole Dimensions

- Panel hole dimensions are given below.
- The recommended panel thicknesses are given below.

Panel hole dimension	Panel thickness
22.3 dia.	0.8 to 5 mm
25.5 dia.	0.8 to 6 mm

- If outer surface treatment such as coating is performed for the panel, the panel dimensions after outer surface treatment must meet the specified panel dimensions.
- The following figure gives pitch dimension A and pitch dimension B between the centers of the mounting holes.

Panel Hole Dimensions for 22.3 Diameter

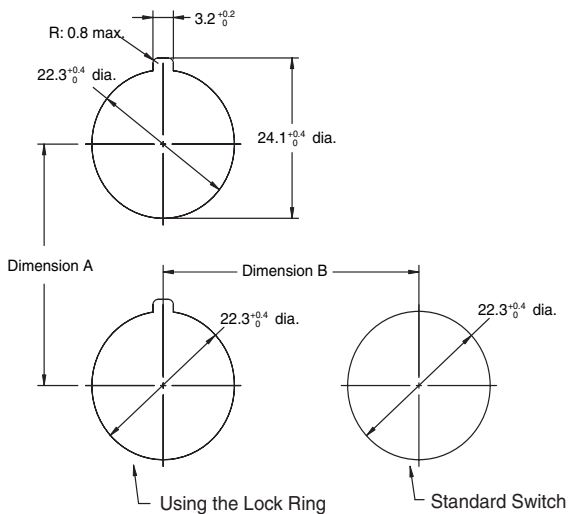

Panel Hole Dimensions for 25.5 Diameter

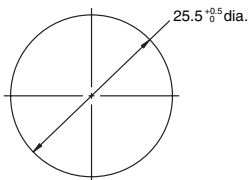

Dimension A

Wire type	Number of linked Contact Blocks	Number of wires per terminal	Minimum allowable pitch Dimension A (mm) or larger
Leads (twisted wires or solid wire)	1	1	50
Bare crimp terminals	1	1	50
Crimp terminals with insulating sheathes	1	1	60

Note: The minimum mounting pitch is based on three Contact Blocks in stage 1 with one wire attached to each terminal. If you attach two wires or link Units, determine the mounting pitch based on the dimensions diagrams and ease of operation and wiring.

Dimension A When Using Accessory

- Dimension A is 50 mm minimum when a Standard Legend Plate Frame is attached.
- Dimension A is 51 mm minimum when a Large Legend Plate Frame is attached.
- Dimension A is 75 mm minimum when a Protective Cover is attached.

Dimension B

Operation Unit shape	Dimension B
Mushroom	40 mm min.
Other than the above	30 mm min.

Mounting the Operation Unit

- **Panel Hole of 22.3-mm Diameter**
Insert the Operation Unit from the front of the panel, insert the Lock Ring and Mounting Nut from the back of the panel, and tighten the Mounting Nut. Before tightening, check that the rubber washer is present between the Operation Unit and the panel.

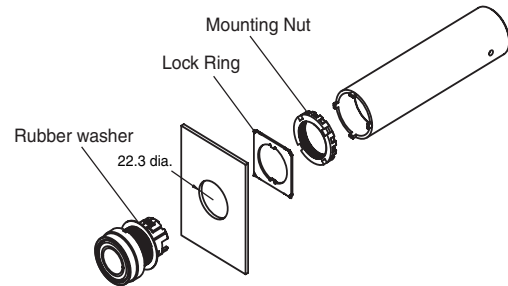

- **Panel Hole of 25.5-mm Diameter**
Do not use the Lock Ring, and tighten the Mounting Nut while confirming that the projecting part (see following figure) on the Mounting Nut is aligned with mounting hole. Before tightening, check that the rubber washer is present between the Operation Unit and the panel.

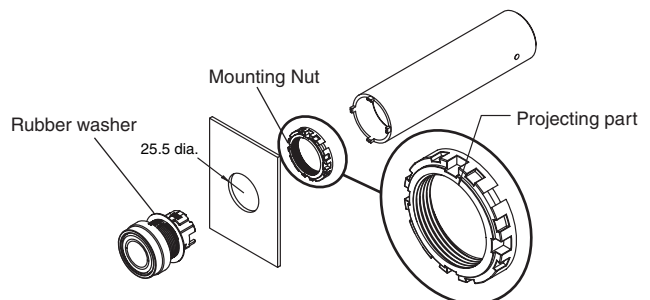

- Align the Lock Ring with the slot on the case and insert it so that the edge is flush with the panel.

Mounting the Contact Block to the Operation Unit

- Insert the Operation Unit into the Mounting Collar, aligning the TOP mark inscribed on the Operation Unit with the lever on the Mounting Collar, and then turn the lever in the direction indicated by the arrow in the following figure all of the way until it clicks into place.

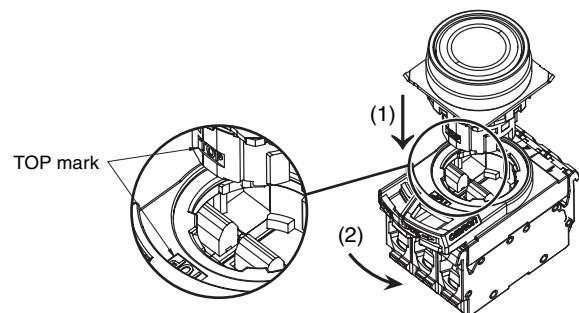

Removing the Mounting Collar

- Press the lock lever in from the back side to release the lock, and then hook the Mounting Collar with a screwdriver, move it in the direction indicated at (2), and remove it. Turn the lever all of the way until it clicks into place.

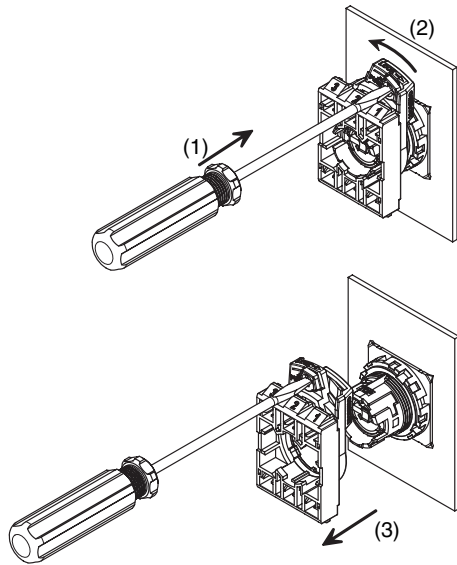

Contact Block

Attaching the Contact Block

- Catch the projection on the opposite side of the Mounting Collar from the lever side and press the Contact Block in the direction indicated at (1).

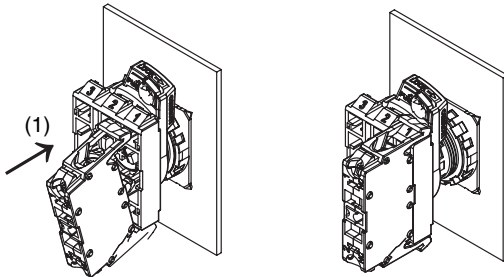

Removing the Contact Block

- Insert a screwdriver into the gap between the Mounting Collar and Contact Block and press it inward in the direction shown at (2).

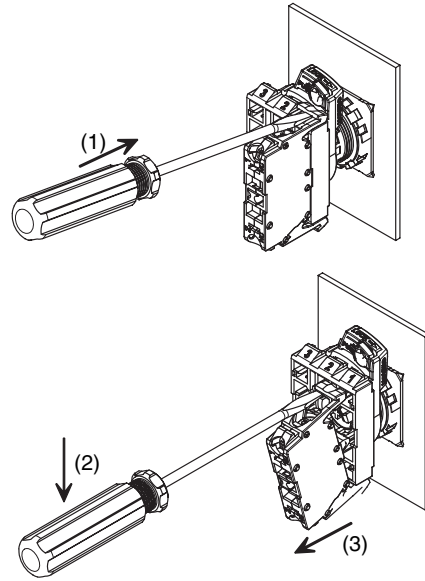

Attaching the Reinforcement Plate

- To link Contact Blocks together, attach a Reinforcement Plate in the direction shown in the following figure. To remove the Plate, insert a screwdriver in the direction indicated at (1) and rotate it in the direction indicated at (2).

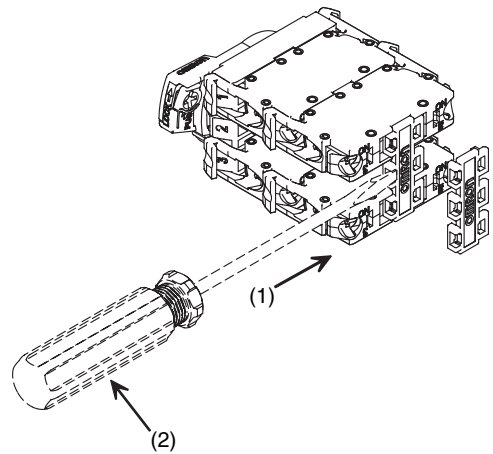

Engraving

- Engrave legends on the Legend Plates.
Do so with the straight part of the Legend Plate positioned on the right and left.
- The characters must be engraved no deeper than 0.5 mm. Use an alcohol-based paint, such as a melamine, phthalic acid, or acrylic resin based paint.

Projected, Full-guard, or Mushroom Switches	Flat Switches
<p>15.4 dia.</p>	<p>17.7 dia.</p>

Attaching Character Films

- To attach a character film, remove the Button and attach the film, aligning it with the straight portions of the Legend Plate.

Projected Switches

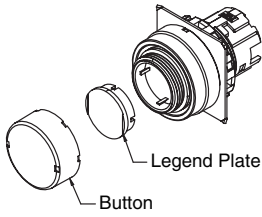

Full-guard Switches

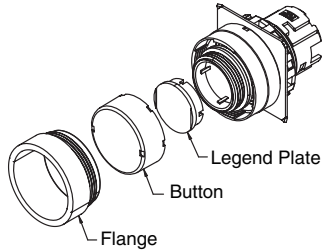

Mushroom Switches

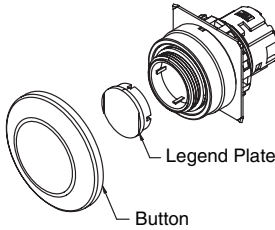

Flat Switches

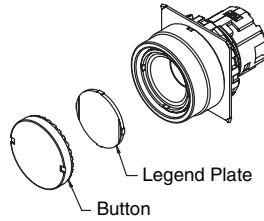

- Prepare films of the following sizes depending on the type of Legend Plate.

Projected, Full-guard, or Mushroom Switches	Legend Plate dimensions	
	Film dimensions	
Flat Switches	Legend Plate dimensions	
	Film dimensions	

Removing and Tightening the Cap

For all Switches except for Mushroom Switches, use the A22Z-3908 Cap Tightening Tool to loosen the cap. When you tighten the cap, make sure that the Legend Plate is in the correct position and then turn the cap in the direction opposite of the direction shown in the following figure. Tighten it to a torque of 0.5 to 1.0 N·m so that it will not become loose.

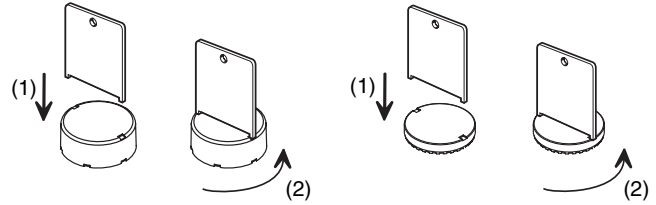

Attaching the LED Lamp to the Lighting Unit

- Insert the protrusions on the LED Lamp into the guides on the Lighting Unit and then turn the LED Lamp in direction (2) to lock it in place.

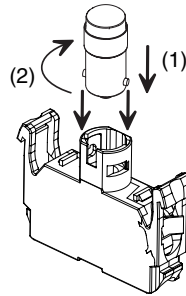

Attaching and Replacing LED Lamps

Removing the LED Lamp from the Panel Surface

- Insert the LED Lamp Extractor as shown in the following figure and then rotate the Extractor in the direction shown at (2) while pressing it inward.

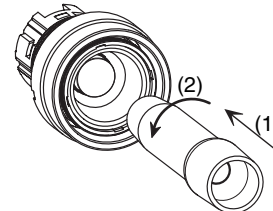

Attaching the LED Lamp from the Panel Surface

- Insert the LED Lamp into the LED Lamp Extractor as shown in the following figure. Align the projections on the LED Lamp with the LED Lamp insertion guides, insert the LED Lamp, and turn it in the direction indicated at (2).

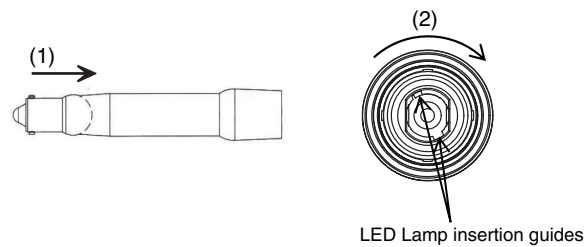

Control Box

You can attach a Legend Plate Frame.
 Attach it in the direction shown in the following figure.
 Mount the Switch in the same way as for a standard panel. The tightening torque of the Box screws is 1.4 to 2.0 N·m.

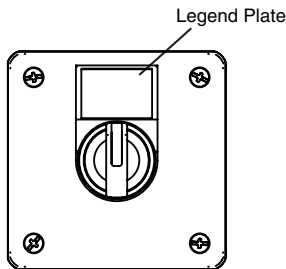

Creating a Cable Hole

To open a cable hole, leave the cover attached, place the tip of a screwdriver in the grooves at four locations around the cable hole, and strike the screwdriver with a hammer to open the hole.

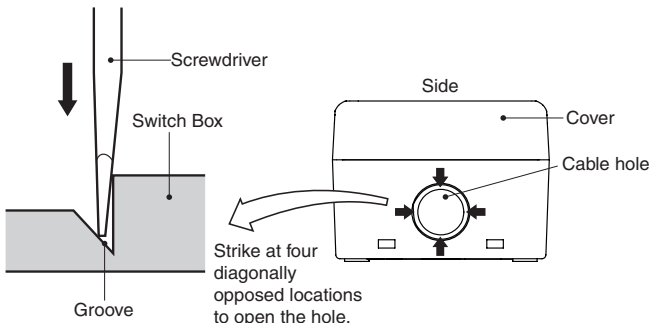

Attaching and Removing Legend Plates

- Press the Legend Plate into the depression in the Legend Plate Frame. The Legend Plate Frame can be separate or it can be mounted on the panel when you attach the Legend Plate.
- The direction of the characters will depend on the mounting direction of the Operation Unit if the Switch is a Selector Switch or Key Selector Switch.

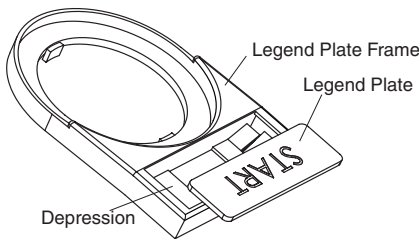

- You can easily remove the Legend Plate by pressing it forwards from the back of the Legend Plate Frame.
- The acrylic plastic Legend Plate is easily damaged by shock. Handle it with care.

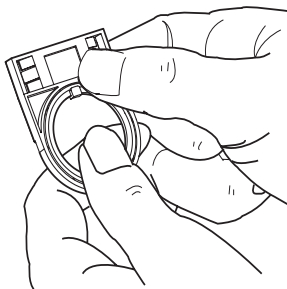

Attaching the Lock Ring

Attach the Lock Ring as shown in the following figure.
 To ensure water resistance, attach the rubber washer in the specified location.

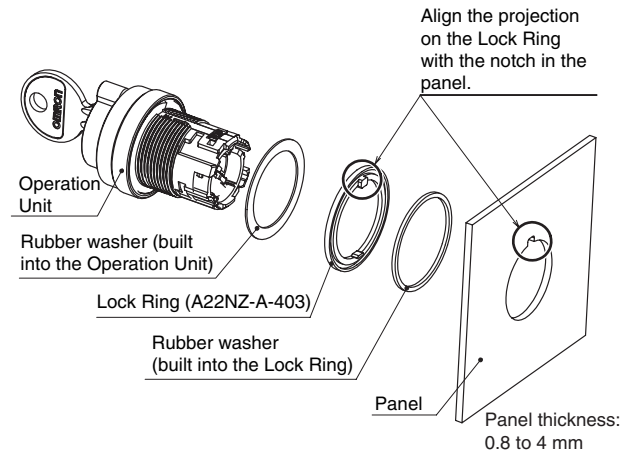

- Align the TOP mark on the Operation Unit, part A on the Legend Plate, and the notch in the panel, and insert the Operation Unit.

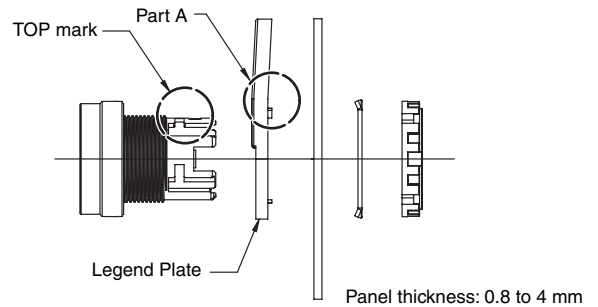

- If there is no notch in the panel, remove part A from the Legend Plate with pliers.

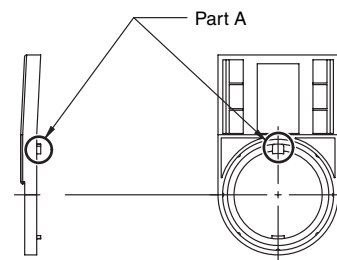

Attaching the Protective Cover

Attach the Protective Cover (A22NZ-A-303) to a panel that is 0.8 to 1.0 mm thick. To ensure water resistance, attach the rubber washer in the specified location.

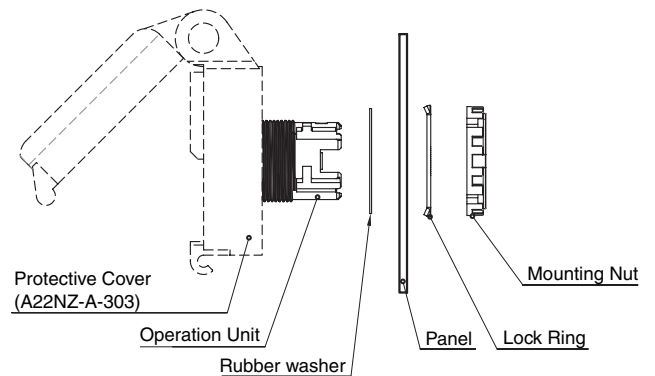

Terms and Conditions of Sale

1. **Offer; Acceptance.** These terms and conditions (these "**Terms**") are deemed part of all quotes, agreements, purchase orders, acknowledgments, price lists, catalogs, manuals, brochures and other documents, whether electronic or in writing, relating to the sale of products or services (collectively, the "**Products**") by Omron Electronics LLC and its subsidiary companies ("**Omron**"). Omron objects to any terms or conditions proposed in Buyer's purchase order or other documents which are inconsistent with, or in addition to, these Terms.
2. **Prices; Payment Terms.** All prices stated are current, subject to change without notice by Omron. Omron reserves the right to increase or decrease prices on any unshipped portions of outstanding orders. Payments for Products are due net 30 days unless otherwise stated in the invoice.
3. **Discounts.** Cash discounts, if any, will apply only on the net amount of invoices sent to Buyer after deducting transportation charges, taxes and duties, and will be allowed only if (i) the invoice is paid according to Omron's payment terms and (ii) Buyer has no past due amounts.
4. **Interest.** Omron, at its option, may charge Buyer 1-1/2% interest per month or the maximum legal rate, whichever is less, on any balance not paid within the stated terms.
5. **Orders.** Omron will accept no order less than \$200 net billing.
6. **Governmental Approvals.** Buyer shall be responsible for, and shall bear all costs involved in, obtaining any government approvals required for the importation or sale of the Products.
7. **Taxes.** All taxes, duties and other governmental charges (other than general real property and income taxes), including any interest or penalties thereon, imposed directly or indirectly on Omron or required to be collected directly or indirectly by Omron for the manufacture, production, sale, delivery, importation, consumption or use of the Products sold hereunder (including customs duties and sales, excise, use, turnover and license taxes) shall be charged to and remitted by Buyer to Omron.
8. **Financial.** If the financial position of Buyer at any time becomes unsatisfactory to Omron, Omron reserves the right to stop shipments or require satisfactory security or payment in advance. If Buyer fails to make payment or otherwise comply with these Terms or any related agreement, Omron may (without liability and in addition to other remedies) cancel any unshipped portion of Products sold hereunder and stop any Products in transit until Buyer pays all amounts, including amounts payable hereunder, whether or not then due, which are owing to it by Buyer. Buyer shall in any event remain liable for all unpaid accounts.
9. **Cancellation; Etc.** Orders are not subject to rescheduling or cancellation unless Buyer indemnifies Omron against all related costs or expenses.
10. **Force Majeure.** Omron shall not be liable for any delay or failure in delivery resulting from causes beyond its control, including earthquakes, fires, floods, strikes or other labor disputes, shortage of labor or materials, accidents to machinery, acts of sabotage, riots, delay in or lack of transportation or the requirements of any government authority.
11. **Shipping; Delivery.** Unless otherwise expressly agreed in writing by Omron:
 - a. Shipments shall be by a carrier selected by Omron; Omron will not drop ship except in "break down" situations.
 - b. Such carrier shall act as the agent of Buyer and delivery to such carrier shall constitute delivery to Buyer;
 - c. All sales and shipments of Products shall be FOB shipping point (unless otherwise stated in writing by Omron), at which point title and risk of loss shall pass from Omron to Buyer; provided that Omron shall retain a security interest in the Products until the full purchase price is paid;
 - d. Delivery and shipping dates are estimates only; and
 - e. Omron will package Products as it deems proper for protection against normal handling and extra charges apply to special conditions.
12. **Claims.** Any claim by Buyer against Omron for shortage or damage to the Products occurring before delivery to the carrier must be presented in writing to Omron within 30 days of receipt of shipment and include the original transportation bill signed by the carrier noting that the carrier received the Products from Omron in the condition claimed.
13. **Warranties.** (a) **Exclusive Warranty.** Omron's exclusive warranty is that the Products will be free from defects in materials and workmanship for a period of twelve months from the date of sale by Omron (or such other period expressed in writing by Omron). Omron disclaims all other warranties, express or implied. (b) **Limitations.** OMRON MAKES NO WARRANTY OR REPRESENTATION, EXPRESS OR IMPLIED, ABOUT NON-INFRINGEMENT, MERCHANTABILITY OR FITNESS FOR A PARTICULAR PURPOSE OF THE PRODUCTS. BUYER ACKNOWLEDGES THAT IT ALONE HAS DETERMINED THAT THE PRODUCTS WILL SUITABLY MEET THE REQUIREMENTS OF THEIR INTENDED USE. Omron further disclaims all warranties and responsibility of any type for claims or expenses based on infringement by the Products or otherwise of any intellectual property right. (c) **Buyer Remedy.** Omron's sole obligation hereunder shall be, at Omron's election, to (i) replace (in the form originally shipped with Buyer responsible for labor charges for removal or replacement thereof) the non-complying Product, (ii) repair the non-complying Product, or (iii) repay or credit Buyer an amount equal to the purchase price of the non-complying Product; provided that in no event shall Omron be responsible for warranty, repair, indemnity or any other claims or expenses regarding the Products unless Omron's analysis confirms that the Products were properly handled, stored, installed and maintained and not subject to contamination, abuse, misuse or inappropriate modification. Return of any Products by Buyer must be approved in writing by Omron before shipment. Omron Companies shall not be liable for the suitability or unsuitability or the results from the use of Products in combination with any electrical or electronic components, circuits, system assemblies or any other materials or substances or environments. Any advice, recommendations or information given orally or in writing, are not to be construed as an amendment or addition to the above warranty. See <http://www.omron247.com> or contact your Omron representative for published information.
14. **Limitation on Liability; Etc.** OMRON COMPANIES SHALL NOT BE LIABLE FOR SPECIAL, INDIRECT, INCIDENTAL, OR CONSEQUENTIAL DAMAGES, LOSS OF PROFITS OR PRODUCTION OR COMMERCIAL LOSS IN ANY WAY CONNECTED WITH THE PRODUCTS, WHETHER SUCH CLAIM IS BASED IN CONTRACT, WARRANTY, NEGLIGENCE OR STRICT LIABILITY. Further, in no event shall liability of Omron Companies exceed the individual price of the Product on which liability is asserted.
15. **Indemnities.** Buyer shall indemnify and hold harmless Omron Companies and their employees from and against all liabilities, losses, claims, costs and expenses (including attorney's fees and expenses) related to any claim, investigation, litigation or proceeding (whether or not Omron is a party) which arises or is alleged to arise from Buyer's acts or omissions under these Terms or in any way with respect to the Products. Without limiting the foregoing, Buyer (at its own expense) shall indemnify and hold harmless Omron and defend or settle any action brought against such Companies to the extent based on a claim that any Product made to Buyer specifications infringed intellectual property rights of another party.
16. **Property; Confidentiality.** Any intellectual property in the Products is the exclusive property of Omron Companies and Buyer shall not attempt to duplicate it in any way without the written permission of Omron. Notwithstanding any charges to Buyer for engineering or tooling, all engineering and tooling shall remain the exclusive property of Omron. All information and materials supplied by Omron to Buyer relating to the Products are confidential and proprietary, and Buyer shall limit distribution thereof to its trusted employees and strictly prevent disclosure to any third party.
17. **Export Controls.** Buyer shall comply with all applicable laws, regulations and licenses regarding (i) export of products or information; (ii) sale of products to "forbidden" or other proscribed persons; and (iii) disclosure to non-citizens of regulated technology or information.
18. **Miscellaneous.** (a) **Waiver.** No failure or delay by Omron in exercising any right and no course of dealing between Buyer and Omron shall operate as a waiver of rights by Omron. (b) **Assignment.** Buyer may not assign its rights hereunder without Omron's written consent. (c) **Law.** These Terms are governed by the law of the jurisdiction of the home office of the Omron company from which Buyer is purchasing the Products (without regard to conflict of law principles). (d) **Amendment.** These Terms constitute the entire agreement between Buyer and Omron relating to the Products, and no provision may be changed or waived unless in writing signed by the parties. (e) **Severability.** If any provision hereof is rendered ineffective or invalid, such provision shall not invalidate any other provision. (f) **Setoff.** Buyer shall have no right to set off any amounts against the amount owing in respect of this invoice. (g) **Definitions.** As used herein, "including" means "including without limitation"; and "Omron Companies" (or similar words) mean Omron Corporation and any direct or indirect subsidiary or affiliate thereof.

Certain Precautions on Specifications and Use

1. **Suitability of Use.** Omron Companies shall not be responsible for conformity with any standards, codes or regulations which apply to the combination of the Product in the Buyer's application or use of the Product. At Buyer's request, Omron will provide applicable third party certification documents identifying ratings and limitations of use which apply to the Product. This information by itself is not sufficient for a complete determination of the suitability of the Product in combination with the end product, machine, system, or other application or use. Buyer shall be solely responsible for determining appropriateness of the particular Product with respect to Buyer's application, product or system. Buyer shall take application responsibility in all cases but the following is a non-exhaustive list of applications for which particular attention must be given: (i) Outdoor use, uses involving potential chemical contamination or electrical interference, or conditions or uses not described in this document. (ii) Use in consumer products or any use in significant quantities. (iii) Energy control systems, combustion systems, railroad systems, aviation systems, medical equipment, amusement machines, vehicles, safety equipment, and installations subject to separate industry or government regulations. (iv) Systems, machines and equipment that could present a risk to life or property. Please know and observe all prohibitions of use applicable to this Product. NEVER USE THE PRODUCT FOR AN APPLICATION INVOLVING SERIOUS RISK TO LIFE OR PROPERTY OR IN LARGE QUANTITIES WITHOUT ENSURING THAT THE SYSTEM AS A WHOLE HAS BEEN DESIGNED TO ADDRESS THE RISKS, AND THAT THE OMRON'S PRODUCT IS PROPERLY RATED AND INSTALLED FOR THE INTENDED USE WITHIN THE OVERALL EQUIPMENT OR SYSTEM.
2. **Programmable Products.** Omron Companies shall not be responsible for the user's programming of a programmable Product, or any consequence thereof.
3. **Performance Data.** Data presented in Omron Company websites, catalogs and other materials is provided as a guide for the user in determining suitability and does not constitute a warranty. It may represent the result of Omron's test conditions, and the user must correlate it to actual application requirements. Actual performance is subject to the Omron's Warranty and Limitations of Liability.
4. **Change in Specifications.** Product specifications and accessories may be changed at any time based on improvements and other reasons. It is our practice to change part numbers when published ratings or features are changed, or when significant construction changes are made. However, some specifications of the Product may be changed without any notice. When in doubt, special part numbers may be assigned to fix or establish key specifications for your application. Please consult with your Omron's representative at any time to confirm actual specifications of purchased Product.
5. **Errors and Omissions.** Information presented by Omron Companies has been checked and is believed to be accurate; however, no responsibility is assumed for clerical, typographical or proofreading errors or omissions.

OMRON AUTOMATION AND SAFETY • THE AMERICAS HEADQUARTERS • Chicago, IL USA • 847.843.7900 • 800.556.6766 • www.omron247.com

OMRON CANADA, INC. • HEAD OFFICE

Toronto, ON, Canada • 416.286.6465 • 866.986.6766 • www.omron247.com

OMRON ELECTRONICS DE MEXICO • HEAD OFFICE

México DF • 52.55.59.01.43.00 • 01-800-226-6766 • mela@omron.com

OMRON ELECTRONICS DE MEXICO • SALES OFFICE

Apodaca, N.L. • 52.81.11.56.99.20 • 01-800-226-6766 • mela@omron.com

OMRON ELETRÔNICA DO BRASIL LTDA • HEAD OFFICE

São Paulo, SP, Brasil • 55.11.2101.6300 • www.omron.com.br

OMRON ARGENTINA • SALES OFFICE

Cono Sur • 54.11.4783.5300

OMRON CHILE • SALES OFFICE

Santiago • 56.9.9917.3920

OTHER OMRON LATIN AMERICA SALES

54.11.4783.5300

OMRON EUROPE B.V. • Wegalaan 67-69, NL-2132 JD, Hoofddorp, The Netherlands. • +31 (0) 23 568 13 00 • www.industrial.omron.eu

Authorized Distributor:

Automation Control Systems

- Machine Automation Controllers (MAC) • Programmable Controllers (PLC)
- Operator interfaces (HMI) • Distributed I/O • Software

Drives & Motion Controls

- Servo & AC Drives • Motion Controllers & Encoders

Temperature & Process Controllers

- Single and Multi-loop Controllers

Sensors & Vision

- Proximity Sensors • Photoelectric Sensors • Fiber-Optic Sensors
- Amplified Photomicrosensors • Measurement Sensors
- Ultrasonic Sensors • Vision Sensors

Industrial Components

- RFID/Code Readers • Relays • Pushbuttons & Indicators
- Limit and Basic Switches • Timers • Counters • Metering Devices
- Power Supplies

Safety

- Laser Scanners • Safety Mats • Edges and Bumpers • Programmable Safety Controllers • Light Curtains • Safety Relays • Safety Interlock Switches